

ø22 HW Series Emergency Stop Switches

Emergency Stop Switches (Unibody) Specifications

Standards

Applicable Standards	Mark	File No. or Organization
UL508 CSA C22.2 No. 14		UL/c-UL Listing File No. E55996
EN60947-5-5		TÜV SÜD
		EU Low Voltage Directive
GB14048.5		CCC No.2004010305132908

Specifications

Operating Temperature	-25 to +60°C (no freezing) Illuminated units: -25 to +55°C
Storage Temperature	-40 to +80°C (no freezing)
Operating Humidity	45 to 85% RH (no condensation)
Operating Force	50N
Minimum Force Required for Direct Opening Action	5.5 mm
Maximum Operator Stroke	10 mm
Contact Resistance	50 mΩ maximum (initial value)
Insulation Resistance	100 MΩ minimum (500V DC megger)
Dielectric Strength	Between live and dead metal parts: Contacts: 2,500V AC, 1 minute Illuminated parts: 1,000V AC, 1 minute
Vibration Resistance	Damage limits: 30 Hz, amplitude 1.5 mm Operating extremes: 5 to 55 Hz, amplitude 0.5 mm
Shock Resistance	Damage limits: 1,000 m/s ² Operating extremes: 100 m/s ²
Operating Frequency	900 operations/h
Life	Mechanical: 250,000 operations minimum Electrical: 100,000 operations minimum (at 900 operations/h, duty ratio 40%)
Degree of Protection	IP65
Terminal Style	M3.5 screw
Weight	49g (HW1E-BV402R) 56g (HW1E-LV402Q4R)

Contact Ratings

Rated Insulation Voltage (Ui)		250V			
Rated Thermal Current (Ith)		10A			
Rated Operational Voltage (Ue)		24V	110V	220V	
Rated Operational Current	AC 50/60 Hz	Resistive Load (AC-12)	6A	3A	3A
		Inductive Load (AC-15)	6A	3A	3A
	DC	Resistive Load (DC-12)	6A	2A	1A
		Inductive Load (DC-13)	1.5A	0.3A	0.15A

- Minimum applicable load (reference value): 3V AC/DC, 5 mA (Applicable range may vary with operating conditions and load types.)
- The operational current represents the classification by making and breaking currents (IEC 60947-5-1).

LED Lamp Ratings

Rated Operating Voltage of Unit	LED Lamp		
	Part No.	Rated Voltage	Rated Current
6V AC/DC	LSTD-6R	6V AC/DC ±10%	7 mA
12V AC/DC	LSTD-1R	12V AC/DC ±10%	10 mA
24V AC/DC	LSTD-2R	24V AC/DC ±10%	10 mA

LED Internal Circuit

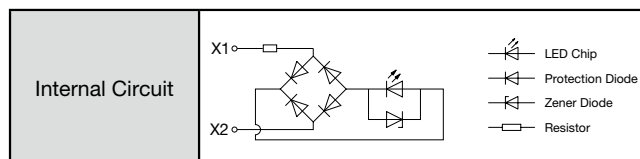

Pushlock Turn Reset Switches (Unibody)

Shape	Contact	Part No.	Button Color
ø40mm Mushroom Pushlock Turn Reset HW1E-BV4 	1NO-1NC	HW1E-BV411R	Red only
	2NC	HW1E-BV402R	

- When pressed, the button is held depressed. The button is released by turning clockwise.

Illuminated Pushlock Turn Reset Switches (Unibody)

Shape	Contact	Part No.	Button Color
ø40mm Mushroom Pushlock Turn Reset HW1E-LV4 	1NO-1NC	HW1E-LV411Q0R	Red only
	2NC	HW1E-LV402Q0R	

- When pressed, the button is held depressed. The button is released by turning clockwise.
- The illuminated pushlock turn reset switch does not contain a lamp. Order LED lamps separately. For lamps, see page 38.

HW Series Emergency Stop Switches ø22

Dimensions

HW1E-BV4

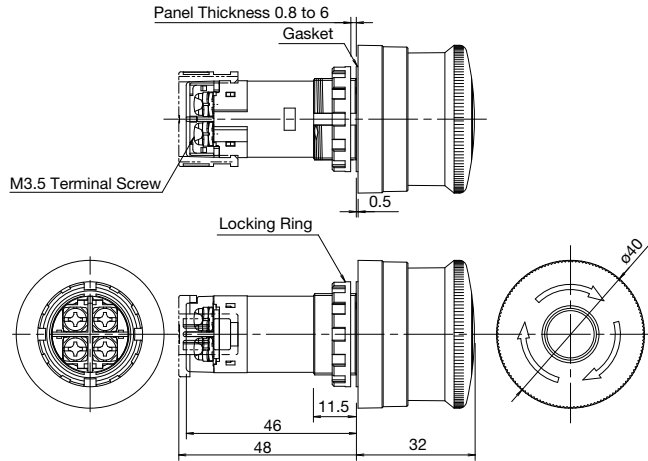

HW1E-LV4

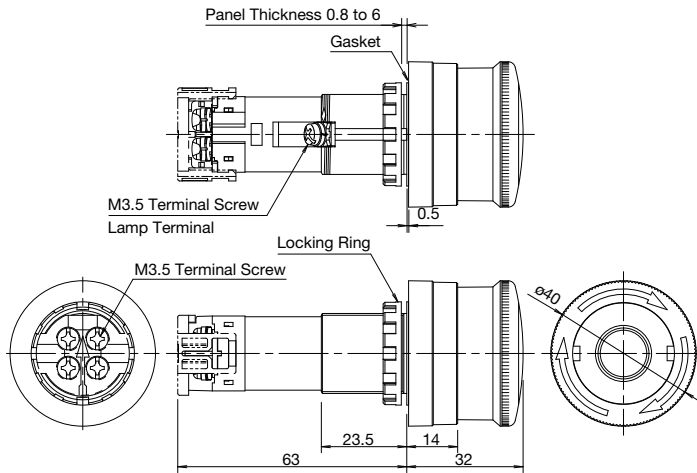

All dimensions in mm.

Mounting Hole

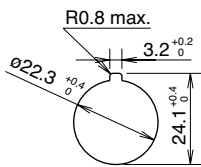

Determine the minimum mounting hole centers in consideration of convenience for wiring.

Terminal Arrangement (Bottom View)

HW1E-BV4

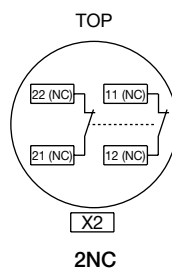
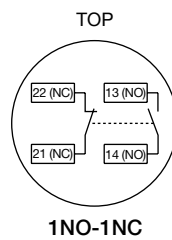

HW1E-LV4

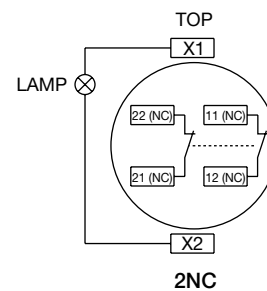
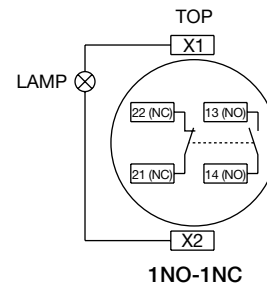

ø22 HW Series Emergency Stop Switches

Emergency Stop Switches (w/Removable Contact Block) Specifications

Standards

Applicable Standards	Mark	File No. or Organization
UL508		UL Listing File No. E68961
CSA C22.2 No. 14		File No. LR92374
EN60947-5-5		TÜV Rheinland
		EU Low Voltage Directive
GB14048.5		CCC No.2005103050145656

Contact Ratings

Contact Block	Rated Insulation Voltage	600V
	Rated Thermal Current	10A
	Contact Ratings by Utilization Category	AC-15 (A600)
	IEC 60947-5-1	DC-13

Characteristics

Contact Ratings by Utilization Category

Operational Voltage			24V	48V	50V	110V	220V	440V
Operational Current	AC 50/60 Hz	AC-12 Control of resistive loads and solid state loads	10A	—	10A	10A	6A	2A
		AC-15 Control of electromagnetic loads (> 72 VA)	10A	—	7A	5A	3A	1A
Operational Current	DC	DC-12 Control of resistive loads and solid state loads	8A	4A	—	2.2A	1.1A	—
		DC-13 Control of electromagnets	4A	2A	—	1.1A	0.6A	—

Specifications

Operating Temperature	-25 to +60°C (no freezing)
Storage Temperature	-40 to +80°C
Operating Humidity	45 to 85% RH (no condensation)
Operating Force	50N
Minimum Force Required for Direct Opening Action	5.5 mm
Maximum Operator Stroke	10 mm
Contact Resistance	50 mΩ maximum (initial value)
Insulation Resistance	100 MΩ minimum (500V DC megger)
Dielectric Strength	Between live and dead metal parts
	Between terminals of different poles
	Between terminals of the same pole
Vibration Resistance	Damage limits: 30 Hz, amplitude 1.5 mm
	Operating extremes: 5 to 55 Hz, amplitude 0.5 mm
Shock Resistance	Damage limits: 1000 m/s ²
	Operating extremes: 100 m/s ²
Operating Frequency	900 operations/h
Life	Mechanical: 500,000 operations minimum (push-pull: 250,000 operations)
	Electrical: 500,000 operations minimum (push-pull: 250,000 operations) (at 900 operations/h, duty ratio 40%)
Degree of Protection	IP65 (IEC 60529)
Terminal Style	M3.5 screw
Weight	76g (HW1B-V322)
	99g (HW1B-X422R)
	54g (HW1B-Y202)
	79g (HW1B-V422R-EMO)

Pushlock Turn Reset Switches (with Removable Contact Block)

Shape	Contact	Part No.	Button Color
ø29mm Mushroom Pushlock Turn Reset HW1B-V3 	1NC	HW1B-V301①	Specify a button color code in place of ① in the Part No. R: red Y: yellow
	1NO-1NC	HW1B-V311①	
	2NC	HW1B-V302①	
	2NO-2NC	HW1B-V322①	
ø40mm Mushroom Pushlock Turn Reset HW1B-V4 	1NC	HW1B-V401①	
	1NO-1NC	HW1B-V411①	
	2NC	HW1B-V402①	
	2NO-2NC	HW1B-V422①	
ø60mm Mushroom Pushlock Turn Reset HW1B-V5 	1NC	HW1B-V501①	
	1NO-1NC	HW1B-V5⑥1①	
	2NC	HW1B-V502①	
	2NO-2NC	HW1B-V522①	

- Yellow buttons cannot be used as emergency stop switches in compliance with EN standards.
- When pressed, the button is held depressed. The button is released by turning clockwise.
- Pushlock turn reset switches with one or three contact blocks contain a dummy block.
- Safety lever lock HW9Z-LS is supplied with the switch.
- Other contact arrangements and gold-plated silver contacts are also available. See page 35.

HW Series Emergency Stop Switches ø22

Pushlock Key Reset Switches (with Removable Contact Block)

Shape	Contact	Part No.	Button Color
ø40mm Mushroom Pushlock Key Reset HW1B-X4 	1NC	HW1B-X401R	Red only
	1NO-1NC	HW1B-X411R	
	2NC	HW1B-X402R	
	2NO-2NC	HW1B-X422R	

- When pressed, the button is held depressed. The button is released by turning the key clockwise.
- Pushlock key reset switches with one or three contact blocks contain a dummy block.
- Two identical keys and safety lever lock HW9Z-LS are supplied with the switch.
- Safety lever lock HW9Z-LS is supplied with the switch.
- Other contact arrangements and gold-plated silver contacts are also available. See Part No. Development.

Push-Pull Switches (with Removable Contact Block)

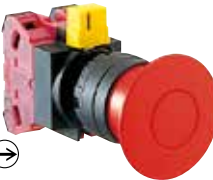
Shape	Contact	Part No.	Button Color
ø40mm Mushroom Push-Pull (2-position) HW1B-Y2 	1NC	HW1B-Y201 ^①	Specify a button color code in place of ^① in the Part No. R: red Y: yellow
	1NO-1NC	HW1B-Y211 ^①	
	2NC	HW1B-Y202 ^①	

- The button is maintained at either pulled or depressed position.
- Push-pull switches are available with one or two contact blocks.
- Push-pull switches with one contact block contain a dummy block.
- Safety lever lock HW9Z-LS is supplied with the switch.

Accessory

Nameplate (for ø22 Emergency Stop Switches)

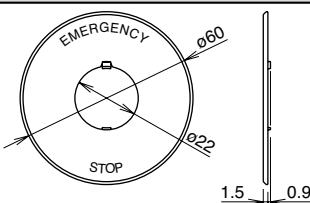
Shape	Name	Part No.	Legend	Package Quantity	Remarks
	Nameplate for Emergency Stop Switch (See page 36 for panel cut-out.)	HWAV-0-Y	(blank)	1	Background: Yellow Legend: Black Applicable panel thickness: 0.8 to 4.5 mm Material: Polyamide Not applicable for ø60 mm mushroom buttons. Legend "EMERGENCY STOP" is indicated outside a ø44mm circle.
		HWAV-27-Y	EMERGENCY STOP		

- EMERGENCY OFF and white nameplates (blank) also available. See page 61 and 64 for details.

Part No. Development

Emergency Stop Switches (w/Removable Contact Block)

For emergency stop purposes, these switches must contain at least one NC contact block.

HW1B-V4 11 R -MAU

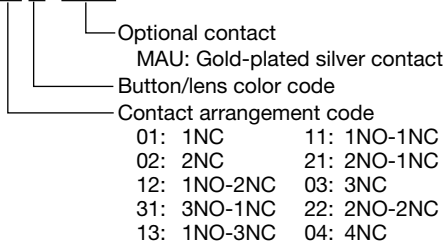

- 01: 1NC 11: 1NO-1NC
 02: 2NC 21: 2NO-1NC
 12: 1NO-2NC 03: 3NC
 31: 3NO-1NC 22: 2NO-2NC
 13: 1NO-3NC 04: 4NC

Note: Push-pull HW1B-Y2 can have a maximum of two contact blocks.

ø22 HW Series Emergency Stop Switches

Dimensions

ø29mm Pushlock Turn Reset
HW1B-V3

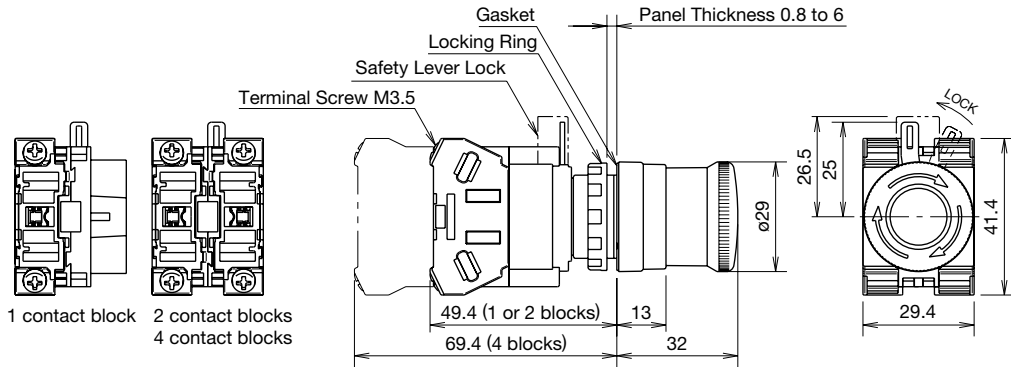

All dimensions in mm.

ø40mm Pushlock Turn Reset
HW1B-V4

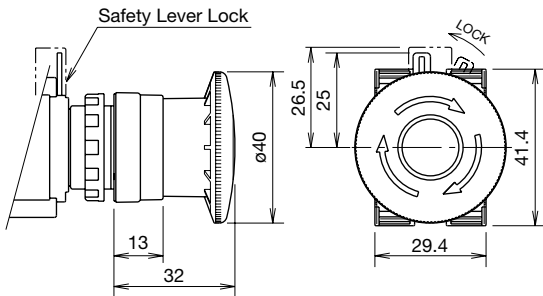

ø60mm Pushlock Turn Reset
HW1B-V5

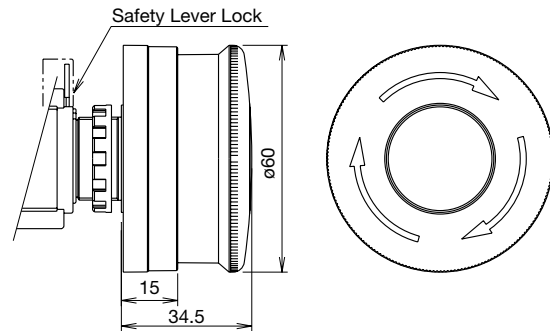

ø40mm Pushlock Key Reset
HW1B-X4

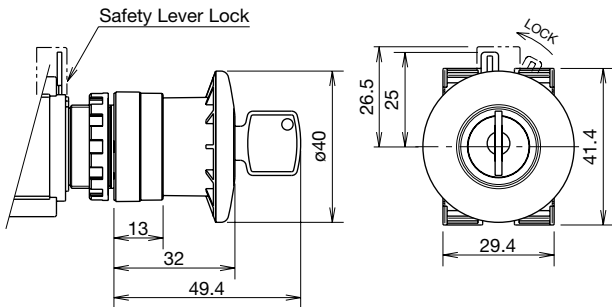

ø40mm Push-Pull
HW1B-Y2

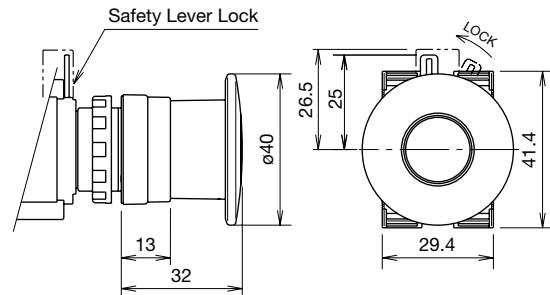

All dimensions in mm.

Panel Cut-Out

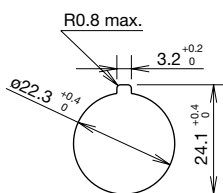

The minimum mounting centers shown below are applicable to emergency stop switches with one layer of contact blocks (two contact blocks). When two layers of contact blocks are mounted, determine the minimum mounting centers in consideration of convenience for wiring.

Minimum Mounting Centers for Emergency Stop Switches











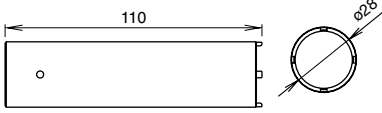

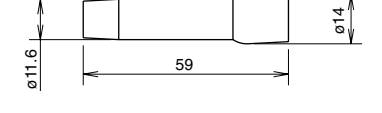
Unit	Vertical Spacing	Horizontal Spacing
HW1B-V3 HW1B-V4 HW1B-X4 HW1B-Y2	50 mm minimum	50 mm minimum
HW1B-V5	60 mm minimum	60 mm minimum

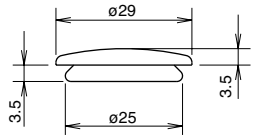
Note: When using the safety lever lock, determine the vertical spacing in consideration of convenience for installing and removing the safety lever lock.

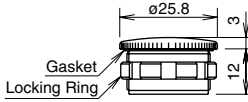
Recommended vertical spacing: 100 mm

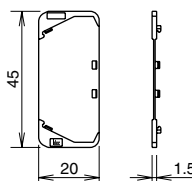
HW Series Emergency Stop Switches ø22

Accessories

Shape	Material	Part No.	Ordering No.	Package Quantity	Description & Dimensions (mm)
	Metal (weight: approx. 150g)	MW9Z-T1	MW9Z-T1	1	<ul style="list-style-type: none"> Used to tighten the locking ring when installing the HW switch onto a panel. Tighten the locking ring to a torque of 2.0 N·m. 
	Rubber	OR-55	OR-55	1	<ul style="list-style-type: none"> Used to install and remove the LED lamps. 
	Rubber (black)	OB-31	OB-31PN05	5	<ul style="list-style-type: none"> Used to plug the unused ø22.2mm mounting holes. 
	Diecast Metal (locking ring: plastic)	LW9Z-BM	LW9Z-BM	1	<ul style="list-style-type: none"> Used to plug the unused ø22.2mm mounting holes. Tighten the locking ring to a torque of 1.2 N·m. IP66 Mounting panel thickness: 0.8 to 6 mm 
	Plastic	HW-VG1	HW-VG1PN10	10	<ul style="list-style-type: none"> Used to prevent contact between adjacent lead wires when units are mounted closely. Barriers should always be used in close mounting. 
	Rubber	HW9Z-A25	HW9Z-A25PN05	5	<ul style="list-style-type: none"> Used to install the HW/TW units into ø25 mounting holes. IP65 Cannot be used with anti-rotation ring and nameplate. Mounting panel thickness: 1.2 to 6.0 mm
	Adapter: Plastic Washer: Metal	HW9Z-A30	HW9Z-A30PN02	2	<ul style="list-style-type: none"> Used to install the HW units into ø30 mounting holes (except for HW1E and HW1B-M5/V5). IP65 Cannot be used with anti-rotation ring, nameplate, full-shroud illuminated pushbuttons, pushbutton selectors, and mono-lever switches. Mounting panel thickness: 1.6 to 4.0 mm
	Adapter: Rubber Washer: Metal	HW9Z-A30E	HW9Z-A30EPN02	2	<ul style="list-style-type: none"> Used to install the HW1E units into ø30 mounting holes. IP65 Cannot be used with anti-rotation ring and nameplate. Mounting panel thickness: 1.6 to 3.8 mm

ø22 HW series Emergency Stop Switches

Maintenance Parts

Shape	Material	Part No.	Ordering No.	Package Quantity	Description & Dimensions (mm)
Safety Lever Lock 	Plastic	HW9Z-LS	HW9Z-LSPN10	10	<ul style="list-style-type: none"> • Yellow • 1 piece included as standard
Locking Ring 	Polyamide	HW9Z-LN	HW9Z-LNPN05	5	<ul style="list-style-type: none"> • Black
Gasket 	Nitril rubber	HW9Z-WM	HW9Z-WMPN10	10	
Spare Key 	Metal Brass, nickel-plated	HW9Z-SK-231	HW9Z-SK-231PN02	2	<ul style="list-style-type: none"> • For pushlock key reset switches

LED Lamps (LSTD)

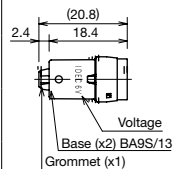
Shape	Rated Operating Voltage	Current Draw		Part No.	Ordering No.	Package Quantity	Base	Dimensions (mm)
		AC	DC					
	6V AC/DC	17 mA	14 mA	LSTD-6R	LSTD-6R	1	BA9S/13	 <p>2.4 (20.8) 18.4 Voltage Base (x2) BA9S/13 Grommet (x1)</p>
		(A, R, W, Y) 8 mA (G, PW, S)	(A, R, W, Y) 5.5 mA (G, PW, S)		LSTD-6RPN10	10		
	12V AC/DC	11 mA	10 mA	LSTD-1R	LSTD-1R	1		
		LSTD-1RPN10	10					
	24V AC/DC	11 mA	10 mA	LSTD-2R	LSTD-2R	1		
					LSTD-2RPN10	10		

Incandescent Lamps (LS)

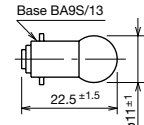
Shape	Rated Operating Voltage	Lamp Ratings	Part No.	Package Quantity	Dimensions (mm)
	6V AC/DC	1W (6.3V)	LS-6	1	 <p>Base BA9S/13 22.5 ± 1.5 ø11 ± 1</p>
	12V AC/DC	1W (18V)	LS-8		
	18V AC/DC	1W (24V)	LS-2		
	24V AC/DC	1W (30V)	LS-3		

HW Series Emergency Stop Switches $\phi 22$

Safety Precautions

- Turn off the power to the HW series control units before starting installation, removal, wiring, maintenance, and inspection of the products. Failure to turn power off may cause electrical shocks or fire hazard.
- To avoid a burn on your hand, use the lamp holder tool when replacing lamps.
- For wiring, use wires of a proper size to meet the voltage and current requirements. Tighten the M3.5 terminal screws to a tightening torque of 1.0 to 1.3 N·m. Failure to tighten terminal screws may cause overheating and fire.

Instructions

Panel Mounting

Remove the contact block from the operator (for transformer pilot lights, remove the transformer from the illumination unit). Remove the locking ring from the operator. Insert the operator into the panel cut-out from the front, tighten the locking ring from the back, then install the contact block to the operator.

Removing and Installing the Contact Block

1. To remove the operator from the contact block, turn the locking lever in the direction of the arrow shown below. Then the operator can be pulled out.
2. To reinstall, place the TOP markings on the operator and the contact block mounting adapter in the same direction, and insert the operator into the contact block mounting adapter. Then turn the locking lever in the opposite direction.



Notes for Panel Mounting

When mounting the operator onto a panel, use the optional locking ring wrench (MW9Z-T1) to tighten the locking ring. Tightening torque must not exceed 2.0 N·m. Do not use pliers. Excessive tightening will damage the locking ring.

Safety Lever Lock

IEEC strongly recommends using the safety lever lock (HW9Z-LS, yellow) to prevent heavy vibration or maintenance personnel from unlocking contacts.

1. HW series can be mounted vertically with a minimum spacing of 50 mm (70 mm for mono-lever switches) but spacing should be determined to ensure easy operation.
2. Mount the control unit onto the panel, lock the lever, and strongly push in the safety lever lock to install.
3. When the spacing is narrower than the recommended value, with the lever unlocked, mount the safety lever lock and insert the contact unit to the operator. Then, lock the lever and strongly push in the safety lever lock to install.
4. To remove the safety lever lock, insert a flat screwdriver into the safety lever lock and push upwards.

