







Think Automation and beyond...

AP/UP Series Miniature Pilot Lights UZ Series Miniature Buzzer





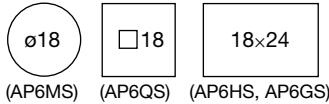



















IDEC CORPORATION

Pilot Lights / Buzzer Selection Guide

Series	AP Series Miniature Pilot Lights				AP6S Series Miniature Pilot Lights		
Mounting Hole Size	ø16	ø12	ø10	ø8	ø16		
Model	AP6M	AP2M	AP1M	AP8M	AP6MS / AP6QS / AP6HS		
Shape							
Unit	Dome Flat	Dome Flat	Dome Flat	Dome Flat	Round, Square, Rectangular, Rectangular 3-sided barrier		
Bezel Size	ø18	ø14	ø12	ø9.8	 (AP6MS) (AP6QS) (AP6HS, AP6GS)		
Bezel Color	Black				Black		
Light Source	Built-in LED				LED lamp (IDEC LSTD)		
Illumination Color	Amber, Green, Red, White, Yellow		Amber, Green, Pure White, Red, Blue, White, Yellow		Amber, Green, Red, Blue, White, Yellow		
Rated Voltage	6V, 12V, 24V DC		5V DC 12V, 24V AC/DC		6V, 12V, 24V AC/DC		
Degree of Protection	IP65 (IEC 60529)			IP40 (IEC 60529)	IP65 (IEC 60529)		
Terminal Style	Solder terminal				Screw terminal (M2.6) Solder/tab terminal #110		
Notes	<ul style="list-style-type: none"> •100/110V AC, 200/220V AC adapter available. •Flashing units (12/24V DC) available. •Built-in current limiting resistor and protection diode. •Marking is available on flat lens. 		<ul style="list-style-type: none"> •Built-in current limiting resistor and protection diode. •Marking is available on flat lens (except ø8). •Waterproof type (degree of protection IP65) available (except ø8). 		<ul style="list-style-type: none"> •Built-in BA9S base LED lamp. •Built-in current limiting resistor and protection diode in LED lamp. •Screw terminals and solder/tab terminals available. 		
Approvals					—		
Page	5	6	7	8	11		

Pilot Lights / Buzzer Selection Guide

UP Series Miniature Pilot Lights				
ø6	ø7	ø8	ø9	ø10
UP06	UP7	UP8	UP9 / UP9P	UP1 / UP1P
				
				
				
3 types	6 types	6 types	6 types	6 types
				
Chrome-plated (Metal)				
Built-in LED				
Amber, Green, Red, White, Yellow				
Without a built-in current limiting resistor only	Without a built-in current limiting resistor With a built-in current limiting resistor (12/24V DC)			
Enclosed type (IP40)			Enclosed type (IP40) Waterproof, oiltight (IP65)	
Solder terminal			Solder terminal	
<ul style="list-style-type: none"> •LED miniature pilot lights available with current limiting resistor (except ø6). •Waterproof (degree of protection IP65) (ø10 and ø9) •Single board mounting applicable types also available (except ø7 and ø6). 				
—				
16, 21	17, 21	18, 21	19	19

Series	UZ series Miniature Buzzer
Mounting Hole Size	ø16
Type	UZ6
Shape	 Buzzer Unit  Cyclical Sound Adapter (for pulsing sound)
Unit	Buzzer unit Continuous sound
Bezel Size	
Bezel Color	Black (buzzer unit: blue)
Rated Voltage	12/24V DC Cyclical sound adapter 12/24V DC
Sound Pressure and Frequency	75 dB (at 1m) at rated voltage, 3.5 kHz ±800 Hz
Sound Cycle	Adjustable between 30 to 600 cycles per minute (period 0.1 to 2 sec)
Degree of Protection	IP40 (Buzzer unit)
Terminal Style	Solder terminal (cyclical sound adapter screw terminal M8)
Notes	<ul style="list-style-type: none"> •Same size and same terminal arrangement as AP6M series miniature pilot lights. •The intermittent sound adapter can be snapped on to the back of the buzzer unit.
Page	23

ø8·10·12·16 AP series Miniature Pilot Lights

Super Bright LEDs with built-in current-limiting resistor and reverse polarity protection diode

- Space saving miniature style.
- Illumination colors: amber, blue, green, pure white, red, white, and yellow (blue and pure white available for AP8M and AP1M only)
- Marking is available on flat lens units. (except AP8M series)
- Built-in protection diode ensures a reverse withstand voltage of 100V.



- See website for details on approvals and standards.



AP2M
AC adapter unit

AP6M
AC adapter unit
Flasher unit

Pilot Light

Input Type	Full voltage						
Model	AP2M / AP6M			AP8M / AP1M			
Rated Voltage	6V DC	12V DC	24V DC	5V DC	12V AC/DC	24V AC/DC	
Voltage Range	Colors except Y	6V DC±5%	12V DC±10%	24V DC±10%	5V DC±10%	12 AC/DC±10%	24V AC/DC±10%
	Y only	6V AC/DC±5%	12V AC/DC±10%	24V AC/DC±10%			
Rated Current	Colors except Y	33mA	22mA	11mA	9mA (A, G, R, W), 7mA (PW, S)		
	Y only	9mA	11mA	11mA	7mA		
Illumination Color Code	A (amber), G (green), R (red), Y (yellow), W (white)			A (amber), G (green), PW (pure white), R (red), S (blue), Y (yellow), W (white)			
Operating Temperature	-20 to +55°C (no freezing)						
Storage Temperature	-30 to +55°C (no freezing)						
Operating Humidity	45 to 85% RH (no condensation)						
Insulation Resistance	Between live and dead parts: 100 MΩ minimum (500V DC megger)						
Dielectric Strength	Between live and dead parts: 1000V, 1 minute						
Reverse Withstand Voltage	100V (AP2M, AP6M), 200V (AP8M, AP1M)						
Solder Terminal	Soldering 350°C maximum (3 sec)						
Applicable Wire	ø1.0 or 0.75 mm ² maximum (20 to 16 AWG)						
Weight (approx.)	AP6M: 7.5g, AP2M: 4.5g, AP1M: 2.5g, AP8M: 2.0g						
Degree of Protection	AP6M, AP2M, AP1M: IP65 AP8M: IP40 (according to IEC 60529)						

AC Adapter/DC-DC Converter (Option)



Unit	AC Adapter	DC-DC Converter
Applicable Unit	AP6M and AP2M (6V rating only)	
Rated Voltage	100/110V AC, 200/220V AC 50/60 Hz	110V DC
Voltage Range	100/110V AC±10% 200/220V AC±10%	90 to 140V
Power Consumption	1.6 VA maximum	1W maximum
Insulation Voltage	250V AC	140V DC
Insulation Resistance	Between live and dead parts: 100 MΩ minimum (500V DC megger)	
	Between live and dead parts: 2000V, 1 minute	
Dielectric Strength	Between I/O terminals: 2000V AC, 1 minute	
	Between I/O terminals: 1500V AC, 1 minute	
Terminal Style	M3 screw	
Weight (approx.)	38g	20g

Flasher Unit (Option)

Applicable Unit	AP6M (12V and 24V DC rating only)
Rated Voltage	12/24V DC compatible
Voltage Range	12/24V DC±10%
Flashing Period	Adjustable between approximately 30 to 600 cycles per minute (period 0.1 to 2 sec)
Current Draw	4 mA (OFF) to 6 mA (ON)
Terminal Style	M3 screw
Weight (approx.)	13.5g

AP Series Miniature Pilot Lights ø16

AP6M Series (ø16)

Shape	Operating Voltage	Part No.	Ordering No.	Package Quantity	Lens Color Code
	6V DC	AP6M266②	AP6M266②	1	Specify a lens color code in place of ② in the Part No. A: amber G: green R: red W: white Y: yellow
			AP6M266②PN10	10	
	12V DC	AP6M211②	AP6M211②	1	
			AP6M211②PN10	10	
	24V DC	AP6M222②	AP6M222②	1	
			AP6M222②PN10	10	
	6V DC	AP6M166②	AP6M166②	1	
			AP6M166②PN10	10	
	12V DC	AP6M111②	AP6M111②	1	
			AP6M111②PN10	10	
	24V DC	AP6M122②	AP6M122②	1	
			AP6M122②PN10	10	

- Degree of protection: IP65 (IEC 60529)
- The LED cannot be replaced.

Note: The voltage for Y (yellow) is 24V AC/DC.

AC Adapter, DC-DC Converter, Flasher Unit

Unit	Operating Voltage	Part No.	Applicable Pilot Light	Package Quantity
AC Adapter	100/110V AC	AP6-016D	AP6M266② (dome: 6V DC) AP6M166② (flat: 6V DC)	1
	200/220V AC	AP6-026D		
DC-DC Converter	110V DC (90 to 140V DC)	AP6-016DD		
Flasher Unit	12/24V DC	UZ6-F10	AP6M211② (dome: 12V DC) AP6M222② (dome: 24V DC) AP6M111② (flat: 12V DC) AP6M122② (flat: 24V DC)	

Dimensions

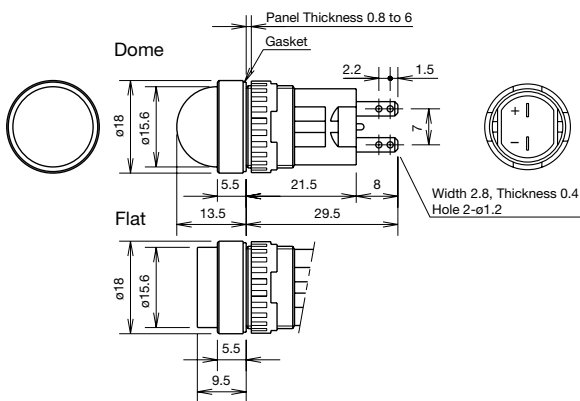

With AC Adapter, DC-DC Converter, Flasher Unit

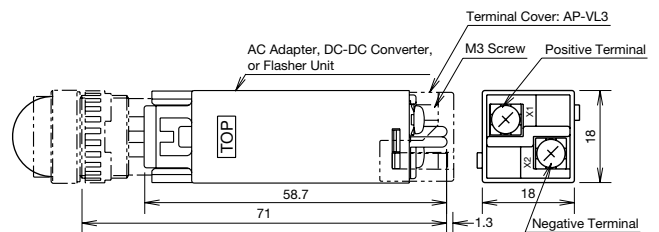

Terminal cover is not supplied.
When using terminal covers, order AP-VL3 terminal covers.

Terminal Arrangement

(Bottom View)

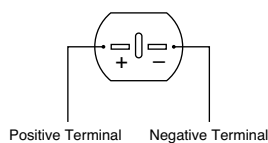

Positive Terminal Negative Terminal

Marking Plate

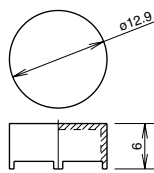

Engraving depth: 0.5 mm maximum
Marking plate material: White acrylic

Panel Cut-out / Mounting Hole Layout

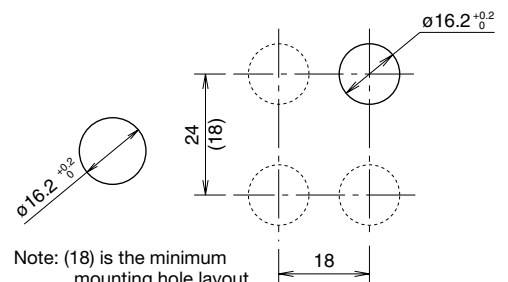



Note: (18) is the minimum mounting hole layout without AC adapter or flasher unit.

All dimensions in mm.

ø12 AP Series Miniature Pilot Lights

AP2M Series (ø12)

Shape	Operating Voltage	Part No.	Ordering No.	Package Quantity	Lens Color Code
	6V DC ±5%	AP2M266②	AP2M266②	1	Specify a lens color code in place of ② in the Part No. A: amber G: green R: red W: white Y: yellow
			AP2M266②PN10	10	
	12V DC ±10%	AP2M211②	AP2M211②	1	
			AP2M211②PN10	10	
	24V DC ±10%	AP2M222②	AP2M222②	1	
			AP2M222②PN10	10	
	6V DC ±5%	AP2M166②	AP2M166②	1	
			AP2M166②PN10	10	
	12V DC ±10%	AP2M111②	AP2M111②	1	
			AP2M111②PN10	10	
	24V DC ±10%	AP2M122②	AP2M122②	1	
			AP2M122②PN10	10	

•Degree of protection: IP65 (IEC 60529)

•The LED cannot be replaced.

Note: The voltage for Y (yellow) is 24V AC/DC.

AC Adapter, DC-DC Converter

Unit	Operating Voltage	Part No.	Applicable Pilot Light	Package Quantity
AC Adapter	100/110V AC	AP2-016D	AP6M266② (dome: 6V DC) AP6M166② (flat: 6V DC)	1
	200/220V AC	AP2-026D		
DC-DC Converter	110V DC (90 to 140V DC)	AP2-016DD		

Dimensions

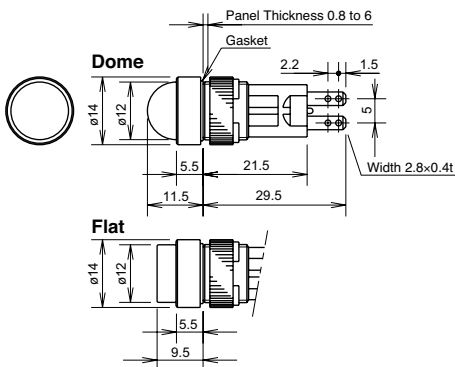

With AC Adapter or DC-DC Converter

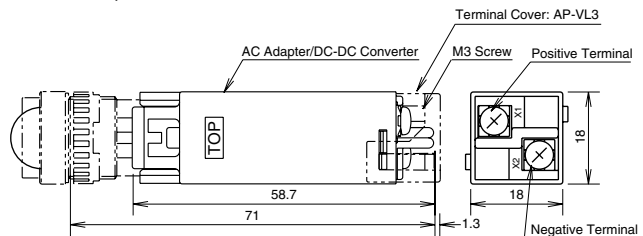

Terminal cover is not supplied.

When using terminal covers, order AP-VL3 terminal covers.

Terminal Arrangement

(Bottom View)

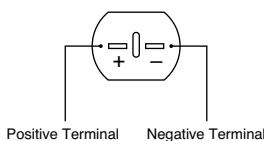

Marking Plate

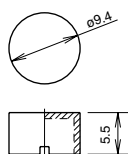

Engraving depth: 0.5 mm maximum
Marking plate material: White acrylic

Panel Cut-out / Mounting Hole Layout

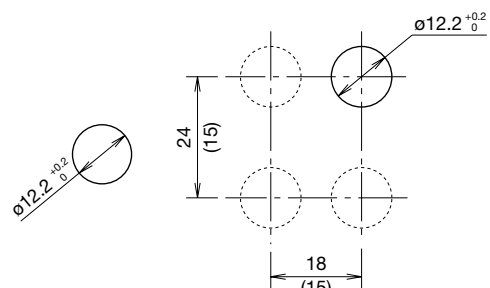



Note: (15) is the minimum mounting hole layout without AC adapter or flasher unit.

All dimensions in mm.

AP Series Miniature Pilot Lights ø10

AP1M Series (ø10)

Shape	Operating Voltage	Part No.	Ordering No.	Package Quantity	Lens Color Code
	5V DC ±5%	AP1M255②	AP1M255②	1	Specify a lens color code in place of ② in the Part No. A: amber G: green PW: pure white R: red S: blue W: white Y: yellow
			AP1M255②PN10	10	
	12V AC/DC ±10%	AP1M211②	AP1M211②	1	
			AP1M211②PN10	10	
	24V AC/DC ±10%	AP1M222②	AP1M222②	1	
			AP1M222②PN10	10	
	5V DC ±5%	AP1M155②	AP1M155②	1	
			AP1M155②PN10	10	
	12V AC/DC ±10%	AP1M111②	AP1M111②	1	
			AP1M111②PN10	10	
	24V AC/DC ±10%	AP1M122②	AP1M122②	1	
			AP1M122②PN10	10	

- Degree of protection: IP65 (IEC 60529)
- The LED cannot be replaced.
- Separate transformer (TWR512, TWR522, TWR542) can be used for 24V AC/DC pilot lights.

Dimensions

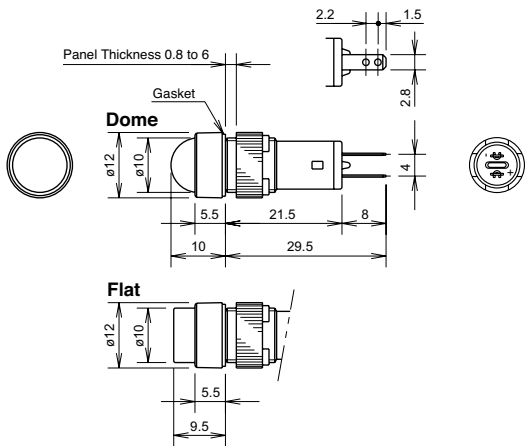

Terminal Arrangement (Bottom View)

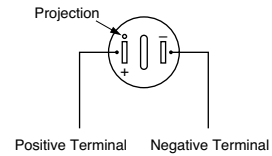

Marking Plate

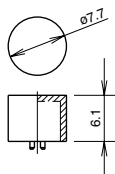

Engraving depth: 0.5 mm maximum
 Marking plate material: White acrylic



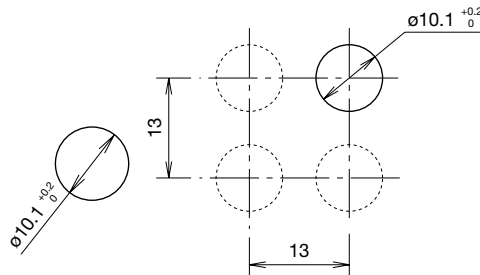

Panel Cut-out / Mounting Hole Layout



All dimensions in mm.

ø16 AP Series Miniature Pilot Lights

AP8M Series (ø8)

Shape	Operating Voltage	Part No.	Ordering No.	Package Quantity	Lens Color Code
 	5V DC ±5%	AP8M255②	AP8M255②	1	Specify a lens color code in place of ② in the Part No. A: amber G: green PW: pure white R: red S: blue W: white Y: yellow
			AP8M255②PN10	10	
	12V AC/DC ±10%	AP8M211②	AP8M211②	1	
			AP8M211②PN10	10	
	24V AC/DC ±10%	AP8M222②	AP8M222②	1	
			AP8M222②PN10	10	
 	5V DC ±5%	AP8M155②	AP8M155②	1	
			AP8M155②PN10	10	
	12V AC/DC ±10%	AP8M111②	AP8M111②	1	
			AP8M111②PN10	10	
	24V AC/DC ±10%	AP8M122②	AP8M122②	1	
			AP8M122②PN10	10	

- The lens or LED cannot be removed or replaced.
- Degree of protection: IP40 (IEC 60529)
- Separate transformer (TWR512, TWR522, TWR542) can be used for 24V AC/DC pilot lights.

Dimensions

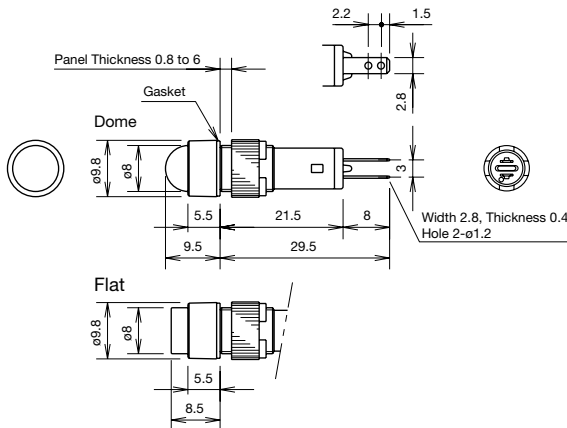

Terminal Arrangement (Bottom View)

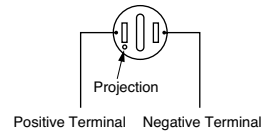



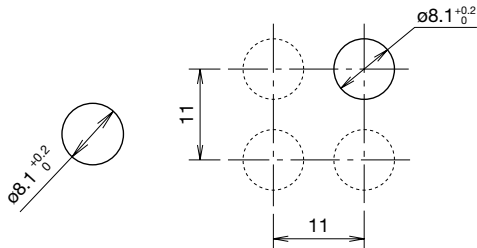

Panel Cut-out / Mounting Hole Layout





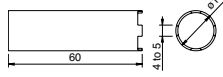

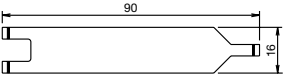
All dimensions in mm.

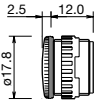
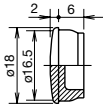
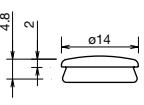
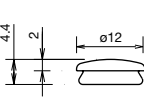
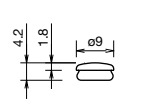
AP Series Miniature Pilot Lights

Accessories

Shape	For	Material	Part No.	Ordering No.	Package Quantity	Remarks										
	ø16	Metal (nickel-plated brass)	MT-001	MT-001	1	<ul style="list-style-type: none"> •Used to tighten the locking ring when installing an AP unit onto an panel. •Tighten the locking ring using a recommended tightening torque.  <table border="1" data-bbox="1300 407 1465 519"> <thead> <tr> <th>Part No.</th> <th>Size</th> </tr> </thead> <tbody> <tr> <td>MT-001</td> <td>ø18</td> </tr> <tr> <td>MT-002</td> <td>ø14</td> </tr> <tr> <td>MT-003</td> <td>ø12</td> </tr> <tr> <td>MT-004</td> <td>ø9.5</td> </tr> </tbody> </table>	Part No.	Size	MT-001	ø18	MT-002	ø14	MT-003	ø12	MT-004	ø9.5
	Part No.		Size													
	MT-001		ø18													
	MT-002		ø14													
MT-003	ø12															
MT-004	ø9.5															
ø12	MT-002	MT-002	1													
ø10	MT-003	MT-003	1													
ø8	MT-004	MT-004	1													
		Stainless steel	MT-100	MT-100	1	<ul style="list-style-type: none"> •Used to remove the AC adapter, DC-DC converter, or flasher unit. 										
	ø16	Metal (diecast) Locking ring (polyacetal)	AL-BM6	AL-BM6	1	<ul style="list-style-type: none"> •Degree of protection: IP65 										
		Nitril rubber (black)	AL-B6	AL-B6PN05	5	<ul style="list-style-type: none"> •Degree of protection: IP65 										
	ø12	Nitril rubber (black)	AL-B2	AL-B2PN05	5	<ul style="list-style-type: none"> •Degree of protection: IP65 										
	ø10	Nitril rubber (black)	AL-B1	AL-B1PN05	5	<ul style="list-style-type: none"> •Degree of protection: IP65 										
	ø8	Nitril rubber (black)	AL-B8	AL-B8PN05	5	<ul style="list-style-type: none"> •Degree of protection: IP65 										

Replacement Parts for AP6M/AP2M/AP1M

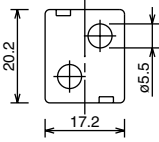
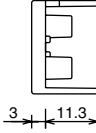
Shape	For	Part No.	Ordering No.	Package Quantity	Lens Color Code	
	AP6M	Dome lens	AP6M-L2②	AP6M-L2②PN05	5	A (amber), G (green), R (red), W (white), Y (yellow) (Note 1)
		Flat lens	AP6M-L1②	AP6M-L1②PN05	5	A (amber), C (clear), G (green), R (red), Y (yellow) (Note 2)
	AP2M	Dome lens	AP2M-L2②	AP2M-L2②PN05	5	A (amber), G (green), R (red), W (white), Y (yellow) (Note 1)
		Flat lens	AP2M-L1②	AP2M-L1②PN05	5	A (amber), C (clear), G (green), R (red), Y (yellow) (Note 2)
	AP1M	Dome lens	AP1M-L2②	AP1M-L2②PN05	5	A (amber), G (green), R (red), S (blue), W (white), Y (yellow) (Note 1)
		Flat lens	AP1M-L1②	AP1M-L1②PN05	5	A (amber), C (clear), G (green), R (red), S (blue), Y (yellow) (Note 2)
	AP6M	Flat lens	AP6M-P1W	AP6M-P1WPN05	5	White
	AP2M		AP2M-P1W	AP2M-P1WPN05	5	
	AP1M		AP1M-PN1W	AP1M-PN1WPN05	5	
	AP1M	Dome lens	AP1M-PN2W	AP1M-PN2WPN05	5	White
	AP6M AP2M	AC adapter DC-DC converter Flasher unit	AP-VL3	AP-VL3	1	 

Specify a lens color code in place of ② in the Ordering No.

Note 1: On the dome lens, use a white (W) lens for white (W) illumination.

Note 2: On the flat lens, use a clear (C) lens for white (W) illumination.

AP Series Miniature Pilot Lights

Safety Precautions

- Turn off power to the AP series pilot lights before installation, removal, wiring, maintenance, and inspection. Failure to turn power off may cause electrical shocks or fire hazard.
- For wiring, use wires of proper size to meet the voltage and current requirements. Improper wiring may cause overheating and

create a fire hazard. Tighten the M3 terminal screws to a torque of 0.6 to 1.0 N·m. Failure to tighten terminal screws may cause overheating and fire.

Instructions

Panel Mounting

When mounting the AP series pilot lights on a panel, use the optional locking ring wrench. Do not use pliers. Excessive tightening will damage the locking ring.

Unit	Tightening Torque
AP6M	0.88 N·m
AP2M	0.78 N·m
AP1M	0.29 N·m
AP8M	0.29 N·m

Installing the AC Adapter, DC-DC Converter, and Flasher Unit

1. Make sure that the voltage rating and terminal style of the AP series pilot lights are applicable to the AC adapter, DC-DC Converter, and flasher units.
2. Install the pilot light into a panel cut-out before mounting an AC adapter, DC-DC Converter, or flasher unit. Note that the pilot light cannot be installed in a panel cut-out with an AC adapter, DC-DC Converter, or flasher unit mounted.
3. When installing an AC adapter, DC-DC Converter, or flasher unit, make sure that the TOP marking is on the same side as the TOP marking of the pilot light. AC adapter, DC-DC Converter, and flasher unit are snapped on to the back of the pilot light.
4. To remove the AC adapter, DC-DC Converter, or flasher unit, insert the tip of the removal tool into the joint hook and pull towards you as shown in the photo below.

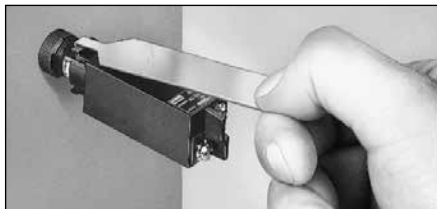

Wiring

1. Note the positive and negative polarities when wiring.
2. All DC type AP series pilot lights contain a diode for protection against reverse polarity and a current limiting resistor, eliminating the need for external resistors.
3. Solder the terminal at 350°C within 3 seconds using a 60W soldering iron. SnAgCu type lead-free solder is recommended. When soldering, do not touch the pilot light housing with the soldering iron. Also ensure that no tensile force is applied to the terminal. Do not bend the terminal or apply excessive force to the terminal.
Use a non-corrosive rosin flux.

DC-DC Converter

DC-DC converters employ an electronic oscillating circuit. Oscillating sounds may be heard depending on operating conditions, but will not affect performance characteristics.

Marking

AP6M, AP2M, and AP1M round flat lenses contain a white marking plate inside the lens. (AP8M lens cannot be removed.)

Flasher Unit

Pierce the round mark on the nameplate on top of the flasher unit with a flat screwdriver and adjust the variable resistor inside. Turn clockwise to lengthen the flashing period.

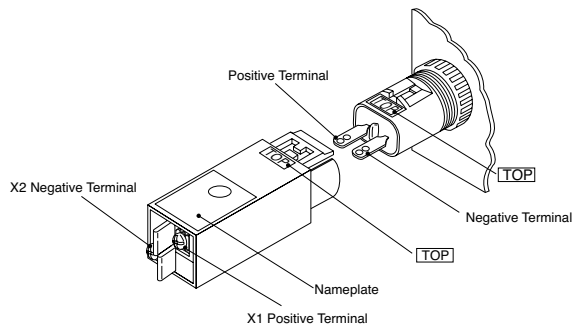

Note: Do not apply excessive force to terminals X1 and X2 during wiring.

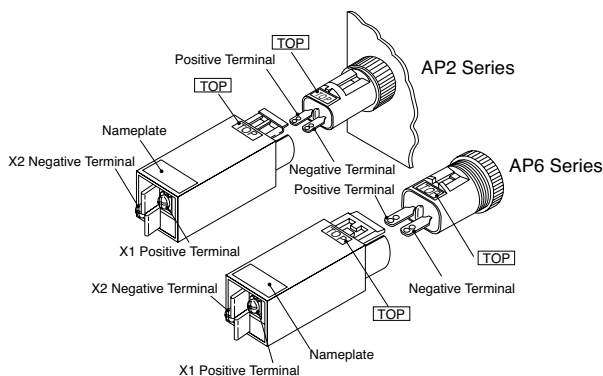

Note: Do not apply excessive force to terminals X1 and X2 during wiring.

5. When using an AC adapter, DC-DC Converter, or flasher unit where the units are subjected to noise, connect a noise suppressor across terminals X1 and X2 as shown in the diagram below.

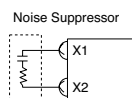

ø16 AP6S Series Miniature Pilot Lights

Miniature Pilot Lights with Super Bright LEDs



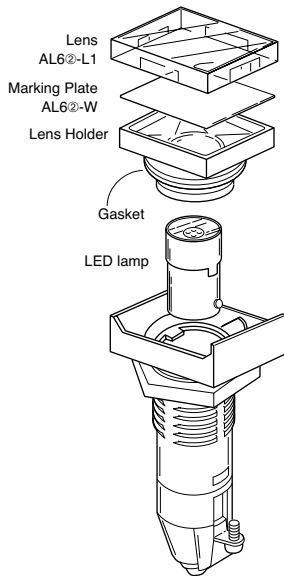

- IDEC's LSTD LED lamps with BA9S base
- Six illumination colors: amber, green, red, blue, white, and yellow
- Screw terminal and solder/tab terminal available
- Degree of protection: IP65
- The current-limiting resistor in the LED lamp eliminates the need for external resistors



Specifications

Illumination	LED		
Rated Voltage	6V AC/DC	12V AC/DC	24V AC/DC
Voltage Range	6V AC/DC±10%	12V AC/DC±10%	24V AC/DC±10%
LED Lamp Part No.	LSTD-6②	LSTD-1②	LSTD-2②
LED Life	50,000 hours approx.		
Operating Temperature	-20°C to +50°C (no freezing)		
Storage Temperature	-30°C to +80°C (no freezing)		
Operating Humidity	45 to 85% RH (no condensation)		
Insulation Resistance	Between live and dead metal parts: 100mΩ minimum (500V DC megger)		
Dielectric Strength	Between live and dead metal parts: 2000V AC, 1 minute		
Terminal Style	Screw terminal: M2.6 Tab terminal: #110 solder/tab terminal (applicable cable: 1.25 mm ² max.)		
Housing Material	Black plastic		
Degree of Protection	IP65 (IEC 60529)		
Weight (approx.)	Terminal screw type: 18g Solder/tab screw type: 9g		

- Specify a color code in place of ② in the LED Lamp Part No.
A (amber), G (green), PW (pure white), R (red), S (blue), W (white), Y (yellow)

Shape	Terminal Style	Operating Voltage	Part No.	Lens Color Code	Built-in LED (Part No.)
Round 	Solder/Tab Terminal	6V AC/DC±5%	AP6MS52②	Specify a lens color code in place of ② in the Part No. A: amber G: green PW: pure white R: red S: blue W: white Y: yellow	LSTD-6②
		12V AC/DC±10%	AP6MS53②		LSTD-1②
		24V AC/DC±10%	AP6MS54②		LSTD-2②
	Screw Terminal	6V AC/DC±5%	AP6MS52M②		LSTD-6②
		12V AC/DC±10%	AP6MS53M②		LSTD-1②
		24V AC/DC±10%	AP6MS54M②		LSTD-2②
Square 	Solder/Tab Terminal	6V AC/DC±5%	AP6QS52②		LSTD-6②
		12V AC/DC±10%	AP6QS53②		LSTD-1②
		24V AC/DC±10%	AP6QS54②		LSTD-2②
	Screw Terminal	6V AC/DC±5%	AP6QS52M②		LSTD-6②
		12V AC/DC±10%	AP6QS53M②		LSTD-1②
		24V AC/DC±10%	AP6QS54M②		LSTD-2②
Rectangular 	Solder/Tab Terminal	6V AC/DC±5%	AP6HS52②	LSTD-6②	
		12V AC/DC±10%	AP6HS53②	LSTD-1②	
		24V AC/DC±10%	AP6HS54②	LSTD-2②	
	Screw Terminal	6V AC/DC±5%	AP6HS52M②	LSTD-6②	
		12V AC/DC±10%	AP6HS53M②	LSTD-1②	
		24V AC/DC±10%	AP6HS54M②	LSTD-2②	
Rectangular with 3-sided Barrier 	Solder/Tab Terminal	6V AC/DC±5%	AP6GS52②	LSTD-6②	
		12V AC/DC±10%	AP6GS53②	LSTD-1②	
		24V AC/DC±10%	AP6GS54②	LSTD-2②	
	Screw Terminal	6V AC/DC±5%	AP6GS52M②	LSTD-6②	
		12V AC/DC±10%	AP6GS53M②	LSTD-1②	
		24V AC/DC±10%	AP6GS54M②	LSTD-2②	

ø16 AP6S Series Miniature Pilot Lights

Dimensions Screw Terminal

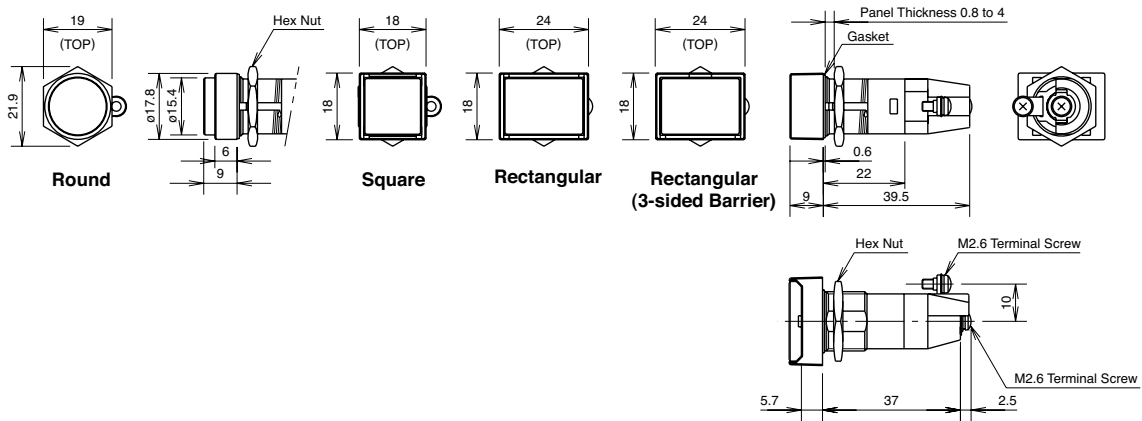

Solder/Tab Screw Terminal

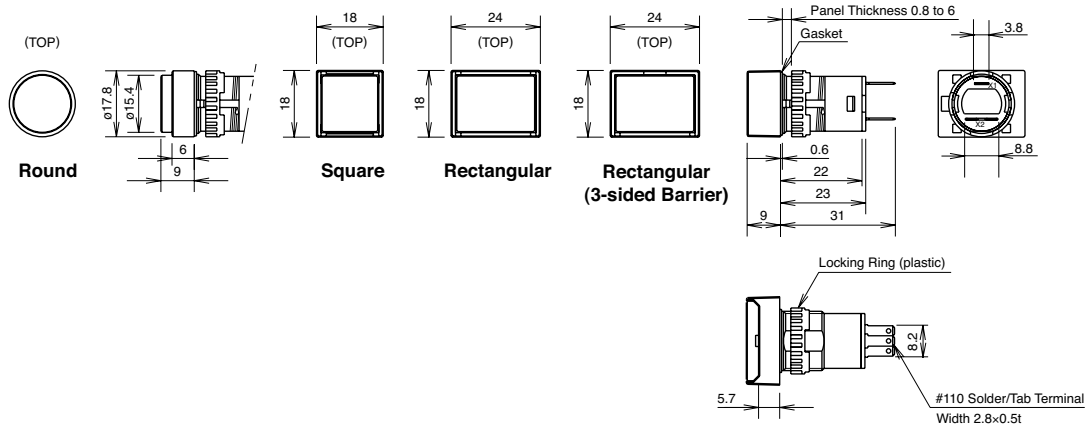

Mounting Hole Layout

All dimensions in mm.

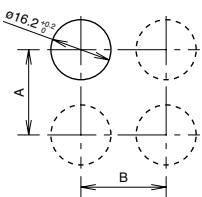

Minimum Mounting Centers

	A		B	
	Round/Square	Rectangular	Round/Square	Rectangular
Screw Terminal	23 mm	23 mm	23 mm	24 mm
Tab Terminal	18 mm	18 mm	18 mm	24 mm

Terminal Arrangement (Bottom View)

Screw Terminal

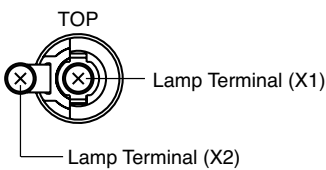

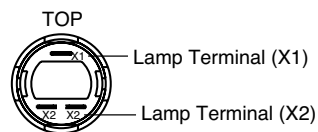

Solder/Tab Terminal



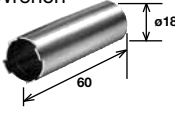

Accessories

Tools

Shape	Specification	Part No.	Ordering No.	Package Quantity	Remarks
Locking Ring Wrench 	Metal (nickel-plated brass)	MT-001	MT-001	1	Used to tighten the locking ring when installing an AP6S unit onto a panel.
Lamp Holder Tool 	Nitril Rubber	OR-55	OR-55	1	Used to install and remove LED lamps.
Lens Removal Tool 	Stainless Steel	MT-101	MT-101	1	Used to remove lens and buttons.

Replacement Parts for AP6M/AP2M/AP1M

Shape	Part No.	Ordering No.	Package Quantity	Remarks	
Lens 	Round	AL6M-L ^②	AL6M-L ^② PN05	5	Specify a color code in place of ^② in the Ordering No. A: amber C: clear G: green R: red S: blue Y: yellow Use a clear lens for white or pure white illumination.
	Square	AL6Q-L ^②	AL6Q-L ^② PN05	5	
	Rectangular Rectangular with 3-sided Barrier	AL6H-L ^②	AL6H-L ^② PN05	5	
Marking Plate 	Round	AL6M-W	AL6M-WPN05	5	White
	Square	AL6Q-W	AL6Q-WPN05	5	
	Rectangular Rectangular with 3-sided Barrier	AL6H-W	AL6H-WPN05	5	

LED Lamps

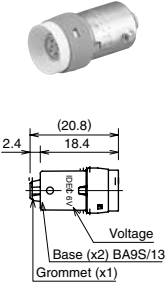
Dimensions	Operating Voltage	Current Draw		Part No.	Ordering No.	②Illumination Color Code	Package Quantity	Base
		AC	DC					
	6V DC ±10%	8 mA	7 mA (A, R, W) 5.5 mA (G, PW, S)	LSTD-6 ^②	LSTD-6 ^②	Specify a color code in place of ^② in the Ordering No. A: amber G: green PW: pure white R: red S: blue W: white	1	BA9S/13
					LSTD-6 ^② PN10		10	
	12V AC/DC ±10%	11 mA	10 mA	LSTD-1 ^②	LSTD-1 ^②	Use a pure white (PW) LED lamp with yellow (Y) lens.	1	
					LSTD-1 ^② PN10		10	
	24V AC/DC ±10%	11 mA	10 mA	LSTD-2 ^②	LSTD-2 ^②	Use a pure white (PW) LED lamp with yellow (Y) lens.	1	
					LSTD-2 ^② PN10		10	

ø16 AP6S Series Miniature Pilot Lights

Transformer

Shape	Primary Voltage	Secondary Voltage	Part No.	Applicable Load
Din Rail Mount Transformer For 6V 	100/110V AC	5.5V AC, 1W	TWR516	LSTD-6 LED lamp (6V AC/DC) or LS-6 incandescent lamp (6V AC/DC, 1W)
	115/120V AC		TWR5126	
	200/220V AC		TWR526	
	230/240V AC		TWR5246	
	380V AC		TWR5386	
	400/440V AC		TWR546	
	480V AC		TWR5486	

Specifications

Operating Voltage	100/110V AC, 115/120V AC, 200/220V AC, 230/240V AC, 380V AC, 400/440V AC, 480V AC (50/60Hz)
Current Draw	2.4 VA
Rated Insulation Voltage	600V
Insulation Resistance	100 MΩ minimum (500V DC megger)
Operating Temperature	-30 to +60°C (no freezing)
Storage Temperature	-40 to +80°C (no freezing)
Operating Humidity	35 to 85% RH (no condensation)
Vibration Resistance	Damage Limits: 30 Hz, amplitude 1.5 mm Operating extremes: 5 to 55 Hz, amplitude 0.5 mm
Shock Resistance	Damage limits: 1,000 m/s ² Operating Extremes: 100 m/s ²
Dielectric Strength	2,500V AC, 1 minute
Terminal Screw	M3.5
Applicable Wire	2 mm ² maximum, 2 wires maximum
Weight (approx.)	87g

Dimensions

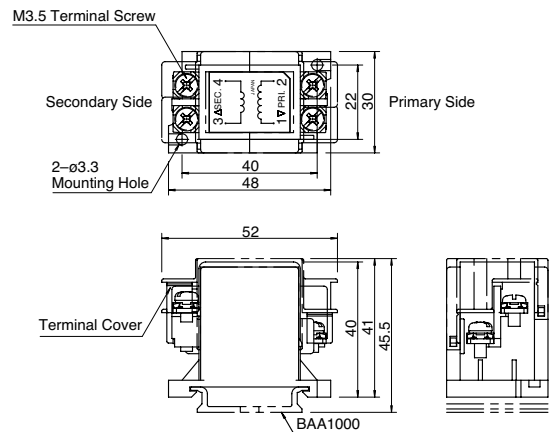

Accessories

DIN Rail

Part No.	Ordering No.	Length	Weight (approx.)	Material	Package Quantity
BAA1000	BAA1000PN10	1000 mm	200g	Aluminum	10
BAP1000	BAP1000PN10	1000 mm	320g	Steel	10

End Clip

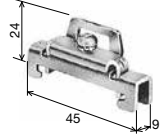
Part No.	Ordering No.	Applicable DIN Rail	Weight (approx.)	Material	Package Quantity	Dimensions
BNL6	BNL6PN10	BAA1000 BAP1000	15g	Steel (Zinc-plated)	10	 <p>Dimensions: 24mm height, 45mm length, 9mm width.</p>

Safety Precautions

- Turn off power to the AP6S series units before installation, removal, wiring, maintenance, and inspection. Failure to turn power off may cause electrical shocks or fire hazard.
- For wiring, use wires of proper size to meet the voltage and current requirements. Improper soldering may cause overheating and create fire hazards.

Instructions

Replacing Lens and Marking Plate

Removal

Remove the operator (color lens, marking plate, and lens holder) by holding the color lens recesses with the Lens Removal Tool (MT-101) and pulling it out. Remove the marking plate by disengaging the latches between the color lens and lens holder. The marking plate must be engraved on the front side as shown below.

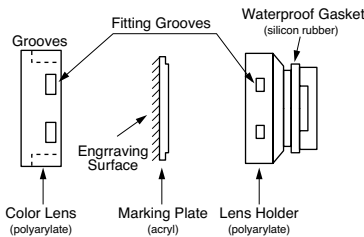

Installation

Place the marking plate on the lens holder in the correct direction and press the color lens onto the lens holder to engage the latches. Insert the lens holder into the housing in the correct direction.

Marking Plate and Engraving Area

Engraving must be made on the engraving area less than 0.5mm deep.

Lens	Round	Square	Rectangular
Built-in Marking Plate	<ul style="list-style-type: none"> • Engraving must be made on the engraving area within 0.5mm deep. • The marking plate is made of white acrylic resin. 		
Applicable Marking Film			
	<ul style="list-style-type: none"> *Thickness = 0.1 mm × 1 pc • Marking film is not supplied. • Recommended marking film: Polyester film 		

Notes on Mounting

Screw Terminal

- Because screw terminal types use hexagonal nuts, they cannot be mounted closely together. However, rectangular units can be mounted closely when installed horizontally.
- When removing the hexagonal nuts, loosen the terminal screws. The hexagonal nuts cannot be removed when the terminal screws are tightened.

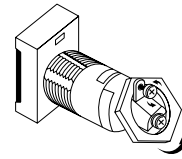

- When mounting the pilot lights collectively, note the mounting order. Pilot lights mounted in between units cannot be removed.

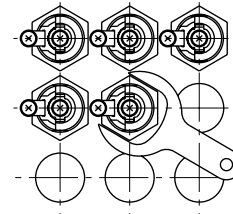

Tab Terminal

The locking ring is plastic. To tighten the ring, use an optional locking ring wrench (MT-001). Do not use pliers. Do not tighten with excessive force, otherwise the locking ring will be damaged. Tightening torque should not exceed 0.88 N·m

Collective Mounting and Continuous Illumination

Collective mounting or continuous illumination of pilot lights may cause the ambient temperature to rise above the rated operating temperature. Make sure to provide efficient ventilation when the mounting panel is not metallic or when the pilot lights are mounted collectively.

Wiring

Solder the terminal at 350°C within 3 seconds using a 60W soldering iron. SnAgCu type lead-free solder is recommended. When soldering, do not touch the pilot light housing with the soldering iron. Also ensure that no tensile force is applied to the terminal. Do not bend the terminal or apply excessive force to the terminal.

Power Supply for LED Lamps

The operating voltage of the LED lamp is within ±5% or ±10% of the rated voltage. Make sure that the power voltage is within this range.

ø6·7·8·9·10 UP series Miniature Pilot Lights

Available in Various Sizes

- Five illumination colors: amber, green, red, white, yellow
- Various sizes and design.
- Available with a built-in current limiting resistor.
- Degree of protection: IP65 (ø9 and ø10)
- Panel thickness 0.6 to 4 mm
(built-in current limiting resistor type 0.6 to 6 mm)

Specifications

Without a Built-in Current Limiting Resistor

Color Code	A (amber), G (Green), R (Red), W (white), Y (yellow)
Rated Current	10 mA (Amber, Green, Red, Yellow) 15 mA (White)
Forward Current	20 mA maximum at 25°C
Reverse Voltage	3V maximum at 25°C
Power Consumption	60 mW maximum at 25°C
Operating Temperature	-20 to +55°C
Storage Temperature	-25 to +80°C
Forward Voltage	Maximum value: 3V Standard value: 2V (forward current: 10 mA)
Dielectric Strength	Between live and dead parts: 500V AC, 1 minute

- Approx. 30,000 hours (until the brightness reduces to 50% of the initial value when lit at complete direct current the rated voltage under 25°C environment.)

With a Built-in Current Limiting Resistor

Color Code	A (amber), G (Green), R (Red), W (white), Y (yellow)
Operating Voltage	12V DC±10%, 24V DC±10%
Rated Current	15 mA
Operating Temperature	-20 to +55°C (no freezing)
Storage Temperature	-25 to +80°C (no freezing)
Operating Humidity	45 to 85% RH (no condensation)
Dielectric Strength	Between live and dead parts: 500V AC, 1 minute

- Approx. 30,000 hours (until the brightness reduces to 50% of the initial value when lit at complete direct current the rated voltage under 25°C environment.)



Panel Cut-out

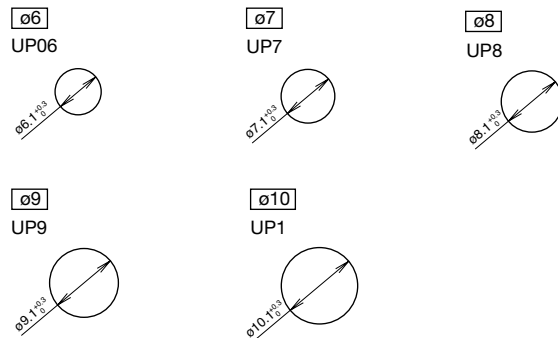





All dimensions in mm.

Weight (example)

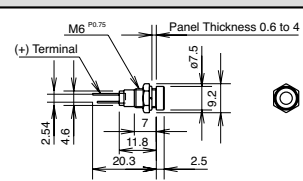
Weight (approx.)	2g (UP06-67)
	5g (UP7-1277)
	6g (UP8-2487)
	7g (UP9-2497)
	8g (UP1-2417)

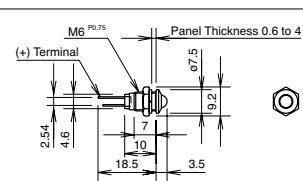

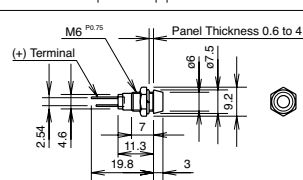









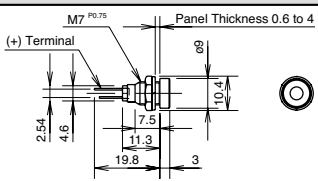



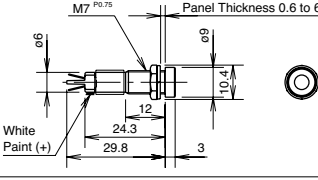

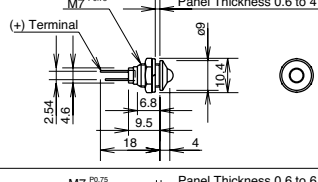
ø6 UP06 Series

Shape	Operating Voltage	Degree of Protection	Part No.	Ordering No.	Color Code	Dimensions	Package Quantity
 (+) ○ (-)	—	IP40	UP06-67②	UP06-67②	Specify a color code in place of ② in the Part No. A: amber G: green R: red W: white Y: yellow		1
				UP06-67②PN10			10
 (+) ○ (-)	—	IP40	UP06-68②	UP06-68②	Specify a color code in place of ② in the Part No. A: amber G: green R: red W: white Y: yellow		1
				UP06-68②PN10			10
 (+) ○ (-)	—	IP40	UP06-69②	UP06-69②	Specify a color code in place of ② in the Part No. A: amber G: green R: red W: white Y: yellow		1
				UP06-69②PN10			10

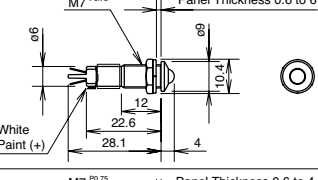
Note: For UP series pilot lights without built-in current limiting resistors, connect an external resistor in series. Otherwise, the LED may be damaged.

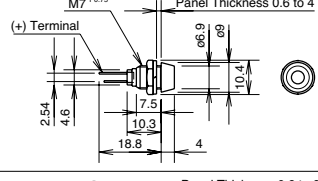



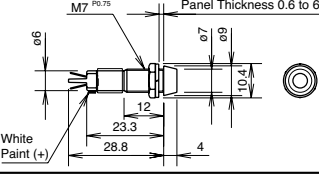



UP Series Miniature Pilot Lights ø6-7-8-9-10

ø7 UP7 Series

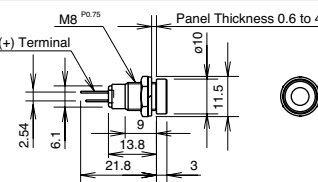
Shape	Operating Voltage	Degree of Protection	Part No.	Ordering No.	Color Code	Dimensions	Package Quantity	
 (+) ○ —  ○ (-)	—	IP40	UP7-77②	UP7-77②	Specify a color code in place of ② in the Part No. A: amber G: green R: red W: white Y: yellow		1	
				UP7-77②PN10			10	
 (+) ○ —   ○ (-)	12V DC ±10%		UP7-1277②	UP7-1277②			1	
	24V DC ±10%			UP7-1277②PN10			10	
				UP7-2477②			UP7-2477②	1
							UP7-2477②PN10	10
 (+) ○ —  ○ (-)	—		UP7-78②	UP7-78②			1	
				UP7-78②PN10			10	
 (+) ○ —   ○ (-)	12V DC ±10%		UP7-1278②	UP7-1278②			1	
	24V DC ±10%			UP7-1278②PN10			10	
				UP7-2478②			UP7-2478②	1
							UP7-2478②PN10	10
 (+) ○ —  ○ (-)	—	UP7-79②	UP7-79②		1			
			UP7-79②PN10		10			
 (+) ○ —   ○ (-)	12V DC ±10%	UP7-1279②	UP7-1279②		1			
	24V DC ±10%		UP7-1279②PN10		10			
			UP7-2479②		UP7-2479②	1		
					UP7-2479②PN10	10		

Note: For UP series pilot lights without built-in current limiting resistors, connect an external resistor in series. Otherwise, the LED may be damaged.

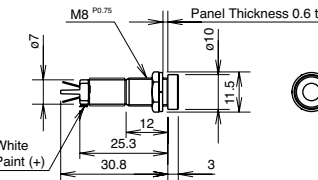

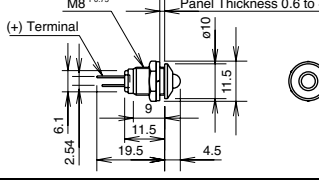
ø8 UP8 Series

Shape	Operating Voltage	Degree of Protection	Part No.	Ordering No.	Color Code	Dimensions (mm)	Package Quantity	
 (+) ○ —  ○ (-)	—	IP40	UP8-87②	UP8-87②	Specify a color code in place of ② in the Part No. A: amber G: green R: red W: white Y: yellow		1	
				UP8-87②PN10			10	
 (+) ○ —   ○ (-)	12V DC ±10%		UP8-1287②	UP8-1287②			1	
	24V DC ±10%			UP8-1287②PN10			10	
				UP8-2487②			UP8-2487②	1
							UP8-2487②PN10	10
 (+) ○ —  ○ (-)	—		UP8-88②	UP8-88②			1	
				UP8-88②PN10			10	

Note: For UP series pilot lights without built-in current limiting resistors, connect an external resistor in series. Otherwise, the LED may be damaged.



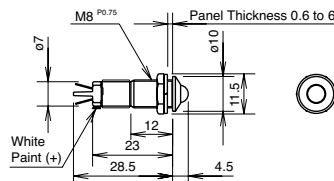
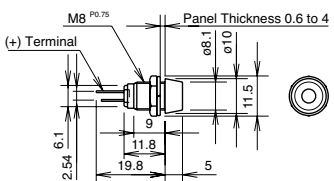

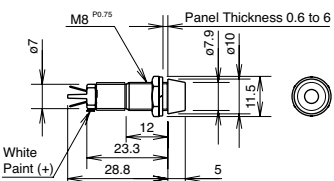

ø6.7.8.9.10 UP Series Miniature Pilot Lights

ø8 UP8 Series

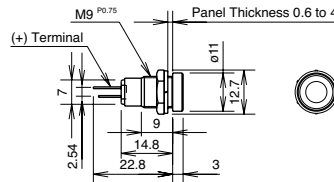
Shape	Operating Voltage	Degree of Protection	Part No.	Ordering No.	Color Code	Dimensions (mm)	Package Quantity	
 (+) o—W— —o (-)	12V DC ±10%	IP40	UP8-1288②	UP8-1288②	Specify a color code in place of ② in the Part No. A: amber G: green R: red W: white Y: yellow		1	
				UP8-1288②PN10			10	
	24V DC ±10%		UP8-2488②	UP8-2488②			1	
				UP8-2488②PN10			10	
Deep Shroud	—		UP8-89②	UP8-89②		UP8-89②		1
						UP8-89②PN10		10
 (+) o—W— —o (-)	12V DC ±10%		UP8-1289②	UP8-1289②		UP8-1289②		1
						UP8-1289②PN10		10
	24V DC ±10%	UP8-2489②	UP8-2489②	1				
			UP8-2489②PN10	10				

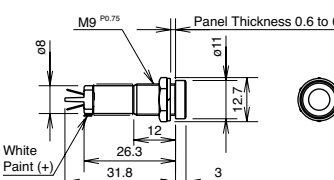
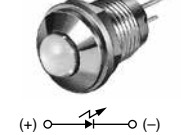
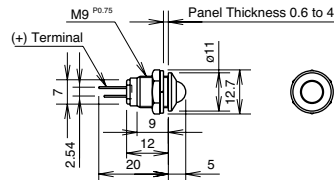
Note: For UP series pilot lights without built-in current limiting resistors, connect an external resistor in series. Otherwise, the LED may be damaged.

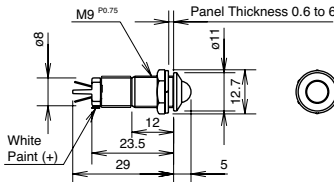
ø9 UP9 Series

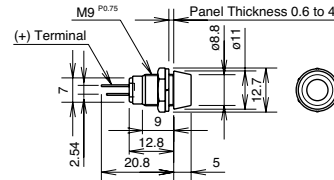
Shape	Operating Voltage	Degree of Protection	Part No.	Ordering No.	Color Code	Dimensions (mm)	Package Quantity	
 (+) o— —o (-)	—	IP40	UP9-97②	UP9-97②	Specify a color code in place of ② in the Part No. A: amber G: green R: red W: white Y: yellow		1	
				UP9-97②PN10			10	
			IP65	UP9P-97②			UP9P-97②	1
							UP9P-97②PN10	10
 (+) o—W— —o (-)		12V DC ±10%	IP40	UP9-1297②		UP9-1297②		1
						UP9-1297②PN10		10
			IP65	UP9P-1297②		UP9P-1297②		1
		UP9P-1297②PN10				10		
	24V DC ±10%	IP40	UP9-2497②	UP9-2497②	1			
				UP9-2497②PN10	10			
IP65				UP9P-2497②	UP9P-2497②	1		
	UP9P-2497②PN10	10						
 (+) o— —o (-)	—	IP40	UP9-98②	UP9-98②	Specify a color code in place of ② in the Part No. A: amber G: green R: red W: white Y: yellow		1	
				UP9-98②PN10			10	
			IP65	UP9P-98②			UP9P-98②	1
							UP9P-98②PN10	10
 (+) o—W— —o (-)		12V DC ±10%	IP40	UP9-1298②		UP9-1298②		1
						UP9-1298②PN10		10
			IP65	UP9P-1298②		UP9P-1298②		1
		UP9P-1298②PN10				10		
	24V DC ±10%	IP40	UP9-2498②	UP9-2498②	1			
				UP9-2498②PN10	10			
IP65				UP9P-2498②	UP9P-2498②	1		
	UP9P-2498②PN10	10						
 (+) o— —o (-)	—	IP40	UP9-99②	UP9-99②		1		
				UP9-99②PN10		10		
			IP65	UP9P-99②		UP9P-99②	1	
						UP9P-99②PN10	10	

Note: For UP series pilot lights without built-in current limiting resistors, connect an external resistor in series. Otherwise, the LED may be damaged.

UP Series Miniature Pilot Lights ø6-7-8-9-10

ø9 UP9 Series

Shape	Operating Voltage	Degree of Protection	Part No.	Ordering No.	Color Code	Dimensions (mm)	Package Quantity	
<p>(+) ○ — W — (+) (-)</p>	12V DC ±10%	IP40	UP9-1299②	UP9-1299②	Specify a color code in place of ② in the Part No. A: amber G: green R: red W: white Y: yellow		1	
				UP9-1299②PN10			10	
		IP65	UP9P-1299②	UP9P-1299②			1	
				UP9P-1299②PN10			10	
		24V DC ±10%	IP40	UP9-2499②			UP9-2499②	1
							UP9-2499②PN10	10
	IP65		UP9P-2499②	UP9P-2499②	1			
				UP9P-2499②PN10	10			

Note: For UP series pilot lights without built-in current limiting resistors, connect an external resistor in series. Otherwise, the LED may be damaged.

ø10 UP1 Series

Shape	Operating Voltage	Degree of Protection	Part No.	Ordering No.	Color Code	Dimensions (mm)	Package Quantity				
<p>(+) ○ — (+) (-)</p>	—	IP40	UP1-17②	UP1-17②	Specify a color code in place of ② in the Part No. A: amber G: green R: red W: white Y: yellow		1				
				UP1-17②PN10			10				
		IP65	UP1P-17②	UP1P-17②			1				
				UP1P-17②PN10			10				
<p>(+) ○ — W — (+) (-)</p>	12V DC ±10%	IP40	UP1-1217②	UP1-1217②	Specify a color code in place of ② in the Part No. A: amber G: green R: red W: white Y: yellow		1				
				UP1-1217②PN10			10				
		IP65	UP1P-1217②	UP1P-1217②			1				
				UP1P-1217②PN10			10				
	24V DC ±10%	IP40	UP1-2417②	UP1-2417②			1				
				UP1-2417②PN10			10				
		IP65	UP1P-2417②	UP1P-2417②			1				
				UP1P-2417②PN10			10				
<p>(+) ○ — (+) (-)</p>	—	IP40	UP1-18②	UP1-18②	Specify a color code in place of ② in the Part No. A: amber G: green R: red W: white Y: yellow		1				
				UP1-18②PN10			10				
		IP65	UP1P-18②	UP1P-18②			1				
				UP1P-18②PN10			10				
<p>(+) ○ — W — (+) (-)</p>	12V DC ±10%	IP40	UP1-1218②	UP1-1218②	Specify a color code in place of ② in the Part No. A: amber G: green R: red W: white Y: yellow		1				
				UP1-1218②PN10			10				
		IP65	UP1P-1218②	UP1P-1218②			1				
	UP1P-1218②PN10			10							
	24V DC ±10%	IP40	UP1-2418②	UP1-2418②			1				
				UP1-2418②PN10			10				
IP65		UP1P-2418②	UP1P-2418②PN10	1							
<p>(+) ○ — (+) (-)</p>	—	IP40	UP1-19②	UP1-19②	Specify a color code in place of ② in the Part No. A: amber G: green R: red W: white Y: yellow		1				
				UP1-19②PN10			10				
		IP65	UP1P-19②	UP1P-19②			1				
				UP1P-19②PN10			10				
		<p>(+) ○ — W — (+) (-)</p>	12V DC ±10%	IP40			UP1-1219②	UP1-1219②	Specify a color code in place of ② in the Part No. A: amber G: green R: red W: white Y: yellow		1
								UP1-1219②PN10			10
IP65	UP1P-1219②		UP1P-1219②	1							
			UP1P-1219②PN10	10							
24V DC ±10%	IP40	UP1-2419②	UP1-2419②	1							
			UP1-2419②PN10	10							
	IP65	UP1P-2419②	UP1P-2419②	1							
			UP1P-2419②PN10	10							

Note: For UP series pilot lights without built-in current limiting resistors, connect an external resistor in series. Otherwise, the LED may be damaged.

ø6.7.8.9.10 UP Series Miniature Pilot Lights

Instructions

Polarity

Pay attention to the polarity of the power supply as UP series units do not contain a diode for protection against reverse polarity. On solder terminal units, the terminal with a white paint marking is positive. On wire-wrap terminal units, the long terminal is positive and the short terminal is negative.

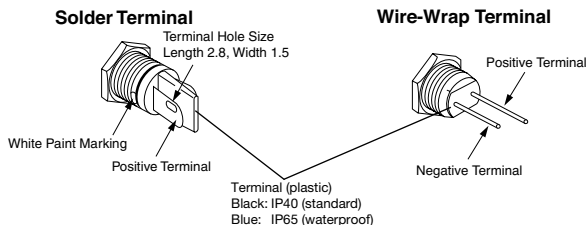

Current Limiting Resistor

When using a UP series unit without a built-in current limiting resistor, connect an external current limiting resistor. Calculate the resistance using the following formula.

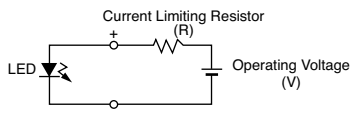

$$\text{Resistance (R)} = \frac{\text{Operating Voltage (V)} - 2}{\text{Rated Current (I)} *}$$

* Rated Current (I) = 10 mA, except white color at 15 mA

Note: Use a resistor of higher resistance than the calculated value (R).

$$\text{Rated Wattage of Resistor (W)} = \frac{\text{Rated Current (I)} \times \text{Operating Voltage (V)}}{2} \times 2 \text{ to } 3 *$$

* 2 to 3 is a safety factor

Reference Value of Current Limit Resistor

Color	Amber, Green, Red, Yellow	White
Operating Voltage		
5V DC	300Ω (1/4W)	200Ω (1/4W)
6V DC	390Ω (1/4W)	270Ω (1/4W)
12V DC	1000Ω (1/4W)	680Ω (1/4W)
24V DC	2200Ω (1/2W)	1500Ω (1/2W)

Waterproof Type

The degree of protection is distinguished by the color of the terminal.

Terminal (Plastic)	Degree of Protection
Black	IP40
Blue	IP65

Wiring

Solder the terminal at 350°C within 3 seconds using a 60W soldering iron. SnAgCu type lead-free solder is recommended. When soldering, do not touch the pilot light housing with the terminal. Do not bend the terminal or apply excessive force to the terminal.

Notes on Operating Voltage

The rated operating voltage represents a complete DC value. When using a pulsating voltage such as a full-wave rectification voltage, keep peak currents within the forward current I_f . Peak currents exceeding I_f may shorten the life of the LED lamp.

Panel Mounting

When mounting UP series units on to the panel, refer to the table below for the recommended tightening torque. Do not tighten with excessive force, otherwise the locking ring will be damaged.

Model	Recommended Tightening Torque
UP06	0.29 N·m
UP7	0.39 N·m
UP8	0.49 N·m
UP9	0.59 N·m
UP9P	0.29 N·m
UP1	0.59 N·m
UP1P	0.29 N·m

UP Series Miniature Pilot Lights (Single Board Mounting)

Single board mounting for miniature LEDs. Same length as H6, L6, and LW series control units

- Five illumination colors: amber, green, red, white, yellow

Specifications

Rated Current	10 mA (Amber, Green, Red, Yellow) 15 mA (White)
Forward Current	20 mA maximum at 25°C
Reverse Voltage	3V maximum at 25°C
Power Consumption	60 mW maximum at 25°C
Operating Temperature	-20 to +55°C (no freezing)
Storage Temperature	-25 to +80°C (no freezing)
Forward Voltage	Maximum value: 3V Standard value: 2V (forward current: 10 mA)
Dielectric Strength	Between live and dead parts: 500V AC, 1 minute
Weight (approx.)	6g (UP8-89V)



ø8 ø9 ø10 UP8 / UP9P / UP1P

Mounting Hole Size	Shape	Degree of Protection	Part No.	Ordering No.	Color Code	Package Quantity
ø8 UP8	Deep shroud	IP40	UP8-89V ^②	UP8-89V ^② PN10	A: amber	10
ø9 UP9	Deep shroud	IP65	UP9P-99V ^②	UP9P-99V ^② PN10	G: green R: red	
ø10 UP1P	Deep shroud	IP65	UP1P-19V ^②	UP1P-19V ^② PN10	W: white Y: yellow	10

•Specify a color code in place of ② in the Part No.

Note: Connect an external current limiting resistor in series. Otherwise, the LED may be damaged.

Dimensions

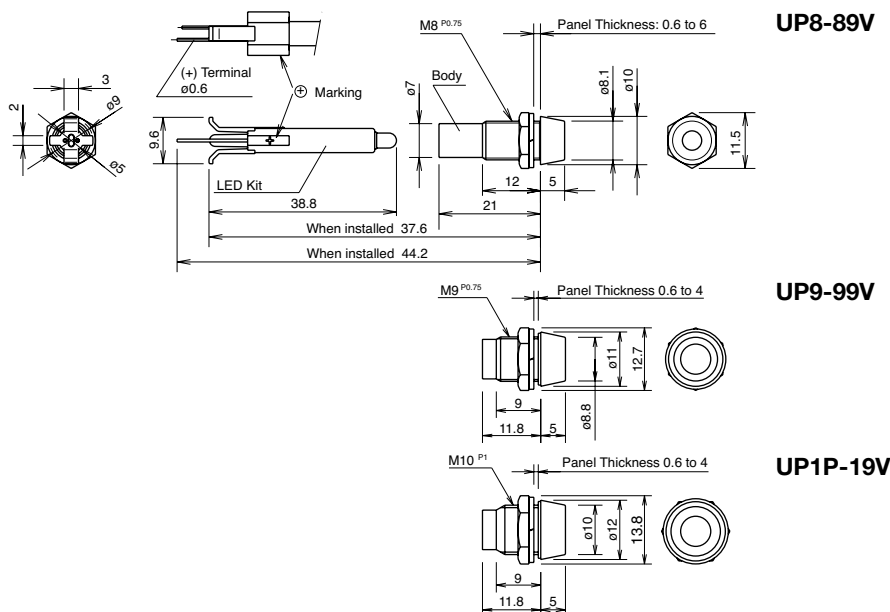

All dimensions in mm.

PC Board Mounting Hole

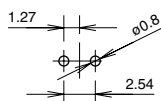

Panel Cut-out

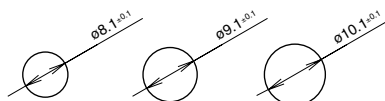

Internal Circuit

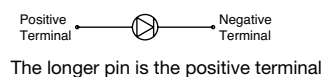

UP Series Miniature Pilot Lights

Safety Precautions

• Turn off power to the unit before installation, removal, wiring, maintenance, and inspection. Failure to turn off may cause electrical shocks or fire hazard.

• For wiring, use wires of a proper size to meet the voltage and current requirements. Improper soldering or failure to tighten the terminal screw may cause overheating and fire.

Instructions

Single Board Mounting

UP series miniature pilot light single board mounting types can be mounted with H6, L6, LW series control units on the same panel. Follow the instructions below on single board mounting.

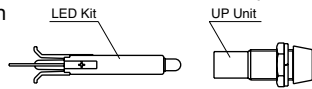

1. Mount the LED kit to the PC board.

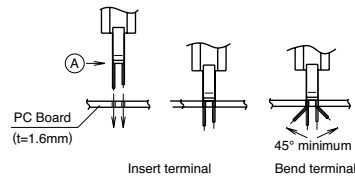

• Temporary mounting
 1. Note the polarity of the terminals and insert the terminals to the PC board.
 2. Make sure that part A of the LED kit is pressed tightly to the PC board. Bend the terminals sideways as shown on the left.

2. Mount the operator and the UP series pilot lights on to the control panel.

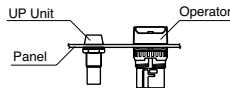

3. Mount the contact block to the operator of the miniature control unit and lock the unit by turning the locking lever.

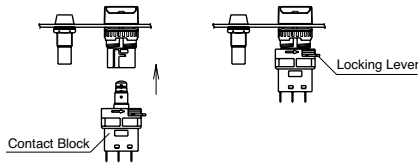

4. Install the PC board in 1. to the panel in 3.

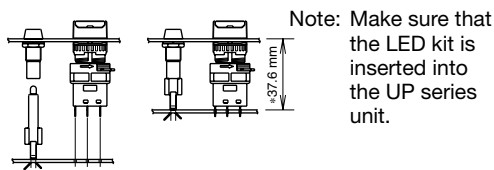

5. Solder the terminals.

Before soldering, make sure that each terminal of the contact block is securely inserted into the PC board holes.

* When mounting H6, L6, LW, and UP series on a single board, make sure that the distance between the front of the panel and the mounting side of the PC board is 37.6 mm.

Polarity

Pay attention to the polarity of the power supply as UP series units do not contain a diode for protection against reverse polarity. The long terminal is positive and the short terminal is negative.

Current Limiting Resistor

When using a UP series unit without a built-in current limiting resistor, connect an external current limiting resistor. Calculate the resistance using the following formula.

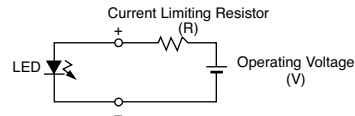

$$\text{Resistance (R)} = \frac{\text{Operating Voltage (V)} - 2}{\text{Rated Current (I)} *}$$

* Rated Current (I) = 10 mA, except white color at 15 mA

Note: Use a resistor of higher resistance than the calculated value (R).

$$\text{Rated Wattage of Resistor (W)} = \text{Rated Current (I)} \times \text{Operating Voltage (V)} \times 2 \text{ to } 3 *$$

* 2 to 3 is a safety factor

Current Limiting Resistor Reference Value

Color	Amber, Green, Yellow, Amber	White
Operating Voltage		
5V DC	300Ω (1/4W)	200Ω (1/4W)
6V DC	390Ω (1/4W)	270Ω (1/4W)
12V DC	1000Ω (1/4W)	680Ω (1/4W)
24V DC	2200Ω (1/2W)	1500Ω (1/2W)

Wiring

Solder the terminal at 350°C within 3 seconds using a 60W soldering iron. SnAgCu type lead-free solder is recommended. When soldering, do not touch the pilot light housing with the terminal. Do not bend the terminal or apply excessive force to the terminal.

Notes on Panel Mounting

Use an optional locking ring wrench to mount the unit onto a panel. Tightening torque should not exceed 0.5 N·m. Do not use pliers. Do not tighten with excessive force, otherwise the locking ring will be damaged.

PC Board and Circuit Design

Use glass epoxy copper clad laminate, double-sided through-hole PC boards with a thickness of 1.6 mm.

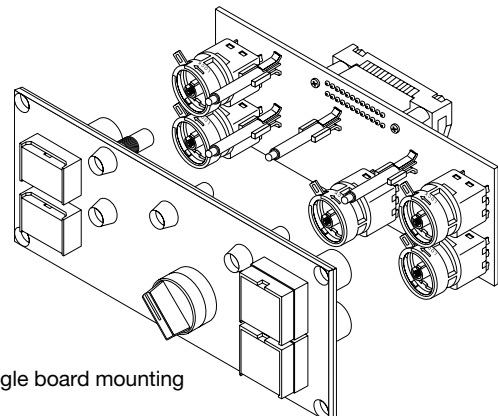

Example of single board mounting

ø16 UZ6 series Miniature Buzzer

Miniature Electronic Buzzer for mounting in ø16 mm Mounting Hole

- Same size and terminal alignment as AP6M series miniature pilot lights.
- Sounds can be adjusted from approximately 30 to 600 cycles per minute using the optional sound adapter.
- The sound adapter can be snapped on to the rear part of the buzzer unit.



Specifications

Buzzer Unit

Insulation Voltage	60V DC
Rated Voltage	12V DC, 24V DC
Voltage Range	12V DC $\pm 10\%$, 24V DC $\pm 10\%$
Current Draw	24 mA
Sound Pressure (at 0.1m)	Steady sound: 75dB (at the rated voltage)
Sound Frequency	3.5 kHz ± 800 Hz
Operating Temperature	-20 to +50°C (no freezing)
Storage Temperature	-25 to +80°C (no freezing)
Operating Humidity	45 to 85% RH (no condensation)
Insulation Resistance	100 M Ω minimum (500V DC megger)
Dielectric Strength	Between live and dead parts: 1,000V AC, 1 minute
Degree of Protection	IP40 (IEC 60529)
Terminal Style	Solder terminal
Applicable Wire	$\phi 1$ or 0.75 mm ² max.
Cap Color	Blue
Weight (approx.)	6.5g

Ratings / Cyclical Sound Adapter

Rated Voltage	12/24V DC
Voltage Range	12/24V DC $\pm 10\%$
Current Draw	30 mA (when installed on the buzzer unit)
Cyclical Sound	30 to 600 cycles per minute (period: 0.1 to 2 sec) ON/OFF time ratio 1:1
Applicable Buzzer Unit	12V DC, 24V DC buzzers (UZ6-11, UZ6-12)
Terminal Screw	M3
Applicable Wire	1.25 mm ² max.
Weight (approx.)	13.5g



Buzzer Unit (continuous sound)

Shape	Terminal Style	Operating Voltage	Part No.	Package Quantity
	Solder	12V DC $\pm 10\%$	UZ6-11	1
		24V DC $\pm 10\%$	UZ6-12	1

Cyclical Sound Adapter

Shape	Terminal Style	Operating Voltage	Part No.	Package Quantity
	Screw	12V/24V DC $\pm 10\%$	UZ6-F10	1

Accessories

Shape	Specification	Part No.	Remarks
	Nickel-plated brass	MT-001	Used to tighten the locking ring when installing a UZ6 buzzer onto a panel.
	Stainless steel	MT-100	Used to remove the cyclical sound adapter from the buzzer. The cyclical sound adapter can be removed by using the tip of the tool as shown in the left photo.
	For cyclical sound adapter	AP-VL3	

ø16 UZ6 Series Miniature Buzzer

Dimensions

Buzzer Unit

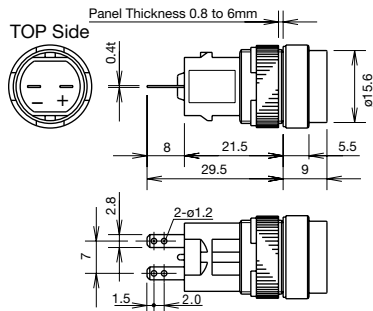

Cyclical Sound Adapter

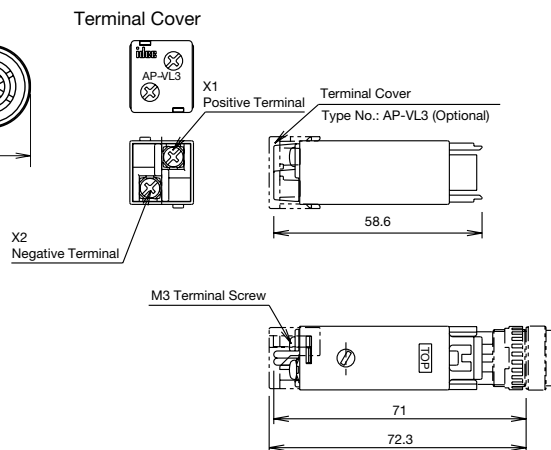

Panel Cut-out

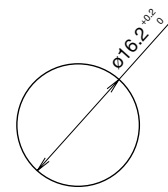

Safety Precautions

• Turn off power to the buzzer before installation, removal, wiring, maintenance, and inspection. Failure to turn off may cause electrical shocks or fire hazard.

• For wiring, use wires of a proper size to meet the voltage and current requirements. Tighten the M3 screw terminal of the cyclical sound adapter to a torque of 0.6 to 1.0 N·m. Improper soldering or failure to tighten the terminal screw may cause overheating and fire.

Instructions

Notes on Panel Mounting

Use an optional locking ring wrench to mount the unit onto a panel. Tightening torque should not exceed 0.88 N·m. Do not use pliers. Do not tighten with excessive force, otherwise the locking ring will be damaged.

Power Supply Noise

When the buzzer is used where power noise might occur, use a noise suppressor element to prevent noise interference.

Cyclical Sound Adjustment

Pierce the round mark on the nameplate on top of the cyclical sound adapter with a flat screwdriver and adjust the variable resistor inside. Turn clockwise for longer cyclical sounds and counterclockwise for shorter cyclical sounds.

Notes on Installing the Cyclical Sound Adapter

1. The cyclical sound adapter can be used on 12V and 24V DC buzzer units (UZ6-11, UZ6-12).
2. Mount the buzzer unit on the panel before installing the cyclical sound adapter on the panel. The buzzer unit cannot be mounted with the cyclical sound adapter installed.
3. When installing the cyclical sound adapter, make sure that the TOP marking on the cyclical sound adapter is on the same side as the TOP marking on the buzzer unit and press in.

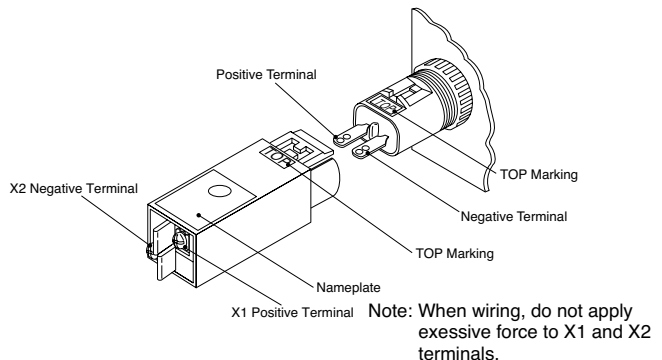

Wiring

Solder the terminal at 350°C within 3 seconds using a 60W soldering iron. SnAgCu type lead-free solder is recommended. When soldering, do not touch the buzzer unit housing with the terminal. Do not bend the terminal or apply excessive force to the terminal.

IDEC CORPORATION

Head Office

6-64, Nishi-Miyahara-2-Chome, Yodogawa-ku, Osaka 532-0004, Japan

USA	IDEC Corporation	Tel: +1-408-747-0550	opencontact@idec.com
Germany	APEM GmbH	Tel: +49-40-25 30 54 - 0	service@eu.idec.com
Singapore	IDEC Izumi Asia Pte. Ltd.	Tel: +65-6746-1155	info@sg.idec.com
Thailand	IDEC Asia (Thailand) Co., Ltd	Tel: +66-2-392-9765	sales@th.idec.com
Australia	IDEC Australia Pty. Ltd.	Tel: +61-3-8523-5900	sales@au.idec.com
Taiwan	IDEC Taiwan Corporation	Tel: +886-2-2698-3929	service@tw.idec.com

Hong Kong	IDEC Izumi (H.K.) Co., Ltd.	Tel: +852-2803-8989	info@hk.idec.com
China/Shanghai	IDEC (Shanghai) Corporation	Tel: +86-21-6135-1515	idec@cn.idec.com
China/Shenzhen	IDEC (Shenzhen) Corporation	Tel: +86-755-8356-2977	idec@cn.idec.com
China/Beijing	IDEC (Beijing) Corporation	Tel: +86-10-6581-6131	idec@cn.idec.com
Japan	IDEC Corporation	Tel: +81-6-6398-2527	marketing@idec.co.jp

 www.idec.com

Specifications and other descriptions in this brochure are subject to change without notice. Information in this catalog is current as of March, 2019. 2019 IDEC Corporation, All Rights Reserved.

EP1449-7

