

# INSTRUCTION SHEET

## USB PANEL-MOUNT EXTENSION CABLE

Read this instruction sheet to ensure correct operation.  
Please keep this instruction sheet for future reference.

### SAFETY NOTE

In this instruction sheet, safety precautions are categorized in order of importance of Warning and Caution:

### WARNING

Warning notices are used to emphasize that improper operation may cause severe personal injury or death.

### CAUTION

Caution notices are used where inattention might cause personal injury or damage to equipment.

### 1 Type

HG9Z-XCE□1

- : USB Type
- 1 : USB A
- 2 : USB miniB

### 2 Packaging contents

Type No.	Product Name	Qty
HG9Z-XCE11	USB A cable	1
	Waterproof cap	1
	Lock Nut	1
	Gasket	1
	USB miniB cable	1
HG9Z-XCE21	Waterproof cap	1
	Lock Nut	1
	Gasket	1

Attachment: Instruction sheet (this sheet)

### 3 Specifications

Length	1000 ± 50 mm
Degree of Protection	IP66 (With the waterproof cap.)

### 4 Notes for operation

- Regularly check that the locking nut is tightened sufficiently. If the lock unit is loose, tighten it to the recommended tightening torque.

### CAUTION

- Turn off the power supply when you set up the unit, connect cables or perform maintenance and inspection.

### 5 External View

- HG9Z-XCE11

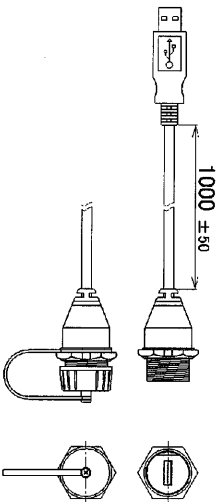

- HG9Z-XCE21

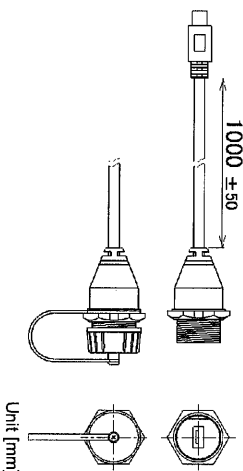

### 6 Dimensions

- USB cable

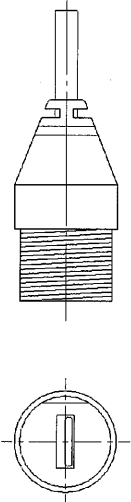

- Waterproof cap

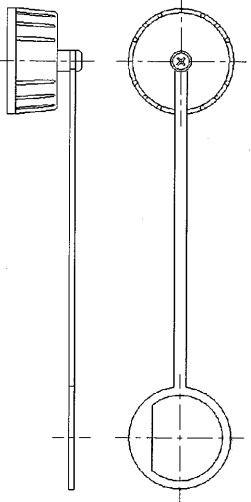

- Lock Nut

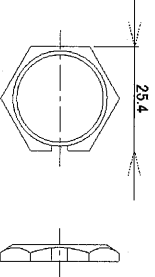

Unit [mm]

- Gasket

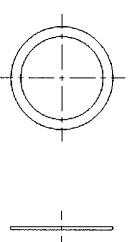

### 7 Installation

- The cable is installed as follows.

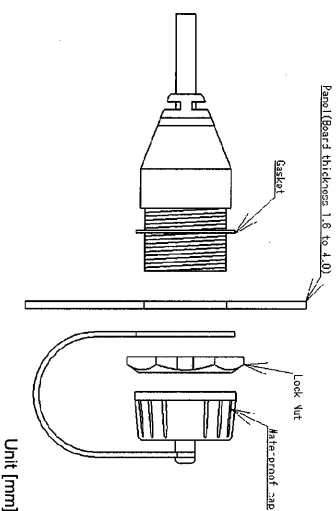

### CAUTION

- If the waterproof cap is securely attached to the cable, then IP66 protection will be achieved.
- Tighten the waterproof cap securely (0.4 N·m).
- Tighten the lock nut with the torque (0.4 N·m).

### 8 Panel cut dimensions

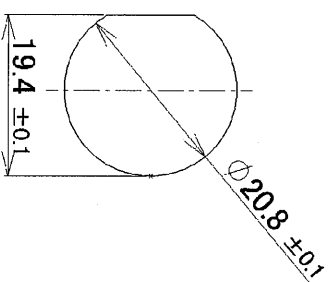

Unit [mm]

### CAUTION

- Do not alter panel cut-out, as this will remove waterproof properties.