



INSTRUCTION SHEET

Original Instructions
Interlock Switch with Solenoid
HS1L Series



Thank you for purchasing this IDEC product. Confirm that the delivered product is what you have ordered. Read this instruction sheet to make sure of correct operation.

SAFETY PRECAUTIONS

In this operation instruction sheet, safety precautions are categorized in order of importance to Warning and Caution :

WARNING

Warning notices are used to emphasize that improper operation may cause severe personal injury or death.

CAUTION

Caution notices are used where inattention might cause personal injury or damage to equipment.

1 Type

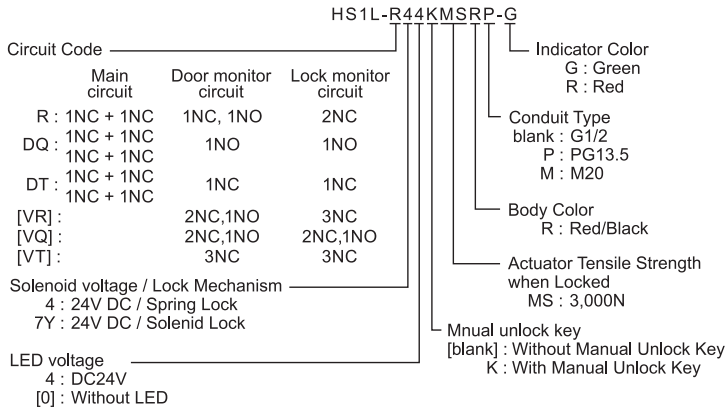

Type Nos. in [] are not supplied as standard. Contact IDEC if required.

CAUTION

Solenoid lock type

- This interlock switch is designed to lock the actuator while the solenoid is energized and to release it when deenergized.
- When the power to the solenoid is interrupted by accident, such as disconnection, the lock is released before a machine stops completely. Then, the worker may be exposed to hazards.
- This interlock switch can be used only for limited applications which do not especially need to be locked for safety.

2 Specifications and Ratings

Applicable Standards	EN ISO / ISO14119 IEC60947-5-1, EN60947-5-1 GS-ET-15, UL508, CSA C22.2 No.14 GB/T14048.5		
Standards for Use	IEC60204-1/EN60204-1		
Interlocking device Type / the level of coded	Type 2 Interlocking device / low level coded actuator (EN ISO / ISO14119)		
Applicable Directives	Machinery Directive, Low Voltage Directive RoHS Directive		
Operating Condition	Operating Temperature	-20 to +55°C (no freezing)	
	Operating Humidity	45 to 85% (no condensation)	
	Storage Temperature	-40 to +80°C (no freezing)	
	Pollution Degree	3	
	Altitude	2000m maximum	
Impulse withstand voltage <Uimp>	4kV (Between ground and LED,solenoid circuit : 1.5kV)		
Rated insulation voltage <Ui>	300V (Between ground and LED,solenoid circuit : 30V)		
Thermal Current <Ith>	10A		
Contact Ratings (Reference Values) <Ue , Ie>	AC	Resistive load(AC-12)	30V 125V 250V 10A 10A 6A
		Inductive load(AC-15)	10A 5A 3A
	DC	Resistive load(DC-12)	8A 2.2A 1.1A
		Inductive load(DC-13)	4A 1.1A 0.6A
Class of Protection	Class II (IEC61140) *1		
Operating Frequency	900 operations/hour		
Operating Speed	0.05 to 1.0 m/s		
B10d	2,000,000 (EN ISO 13849-1 Annex C Table C.1)		
Mechanical Durability	1,000,000 operations min. (GS-ET-19)		
Electrical Durability	100,000 operations min. (900 operations / hour, Rated Load) 1,000,000 operations min. (900 operations / hour, 24V AC/DC 0.1A Resistive Load)		
Shock Resistance	Damage Limits: 1,000m/s ²		
Vibration Resistance	Operating Extremes:10 to 55 Hz, half amplitude 0.35mm Damage Limits: 30 Hz, half amplitude 1.5mm		
Actuator Tensile Strength when Locked	Fzh=3,000N minimum F1max.=3,900N minimum (GS-ET-19) *2, *3, *4		
Direct Opening Travel	11mm min.		
Direct Opening Force	50N min.		
Contact Resistance	50mΩmax. (Initial value)		
Degree of Protection	IP67 (IEC60529)		
Conditional short circuit current	100A (250V)		
Short-circuit protective device	250V, 10A fast acting type fuse *5		
Solenoid	Rated Operating Voltage	24VDC 100%ED	
	Rated Current	200mA (Initial value)	
	Turn ON Voltage	Rated Voltage × 85% max. (at 20°C)	
	Turn OFF Voltage	Rated Voltage × 10% min. (at 20°C)	
Indicator	Rated Power Consumption	Approx. 5W	
	Rated Operating Voltage	24VDC	
	Rated Current	10mA	
	Light Source	LED	
	Lens Color	R(Red), G(Green) (Φ12 Lens)	
Weight	Approx. 450g		

*1 Basic insulation of 4kV impulse withstand voltage is ensured between different contact circuits and between contact circuits and LED or solenoid in the enclosure. When both SELV (interlock extra low voltage) or PELV (protective extra low voltage) circuits and other circuits (such as 230V AC circuits) are used for the solenoid power and contact circuits at the same time, the SELV or PELV requirements are not met any more.

*2 See item 8 Dimensions.

*3 The actuator locking strength is rated at 3,000N of static load. Do not apply a load higher than the rated value. When a higher load is expected to work on the actuator, provide an additional system consisting of another interlock switch without lock (such as the HS5D interlock switch) or a sensor to detect door opening and stop the machine.

*4 F1max. is maximum force. The actuator's guard-locking force Fzh is calculated in accordance with GS-ET-19:

$$F_{zh} = \frac{\text{maximum force (F1max.)}}{\text{Safety coefficient (=1.3)}}$$

*5 Make sure that a fast acting fuse for short-circuit protection trips before overheating of the wires.

Ratings approved by interlock agencies

- | | | |
|---|---|---|
| (1) TÜV rating
AC-15 250V, 3A
DC-13 30V, 4A | (2) UL, c-UL rating
A300 3A, 250V ac, Pilot Duty
4A, 30V dc, Pilot Duty | (3) CCC rating
3A, 250VAC
4A, 30VDC |
|---|---|---|

3 Mounting Examples

- Install the interlock switch on the immovable machine or guard, and install the actuator on the movable door. Do not install both interlock switch and actuator on the movable door, otherwise the angle of insertion of the actuator to the interlock switch may become inappropriate, and failure will occur.

(Examples of Mounting on Sliding Doors)

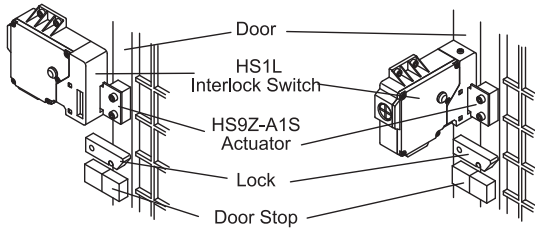

(Examples of Mounting on Hinged Doors)

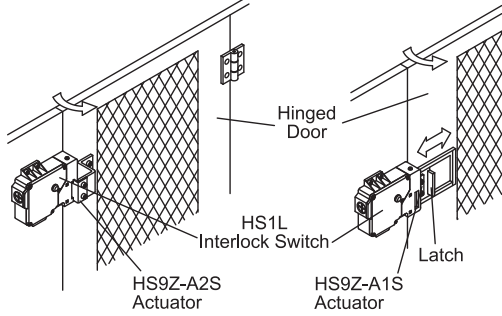

Minimum Radius of Hinged Door

When using the interlock switch for a hinged door, the minimum radius of the applicable door is shown in the following figures.

- L-shaped actuator : HS9Z-A2S

(When the center of the hinged door is on the extension line of the actuator mounting surface.)

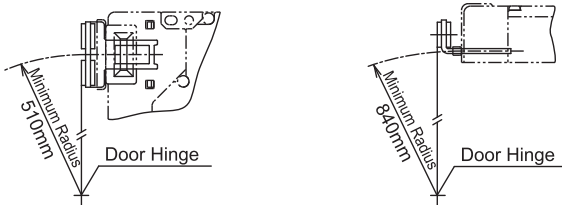

(When the center of the hinged door is on the extension line of the contact surface of actuator and interlock switch.)

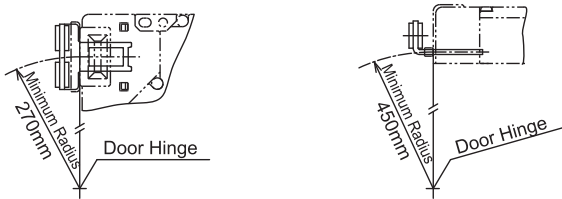

- Adjustable actuator : HS9Z-A3S

(When the center of the hinged door is on the extension line of the actuator mounting surface.)

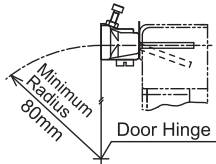

(When the center of the hinged door is on the extension line of the contact surface of actuator and interlock switch.)

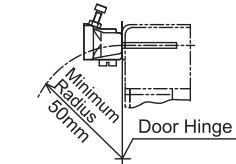

CAUTION

The figures shown above are based on the condition that the actuator enters and exits the actuator entry slot smoothly when the door is closed or opened. Since there may be deviation or dislocation of the hinged door, make sure of correct operation in the actual application before installation.

Actuator Mounting Reference Position

- As shown below, the mounting reference position of the actuator inserted into the interlock switch is the actuator cover or stop film touches the interlock switch lightly. (After mounting the actuator, remove the actuator cover or stop film from the actuator.)

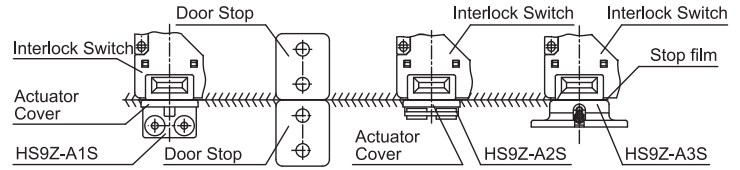

Actuator Mounting Tolerance

- Mounting tolerance of the actuator is 0.5mm from the center of the actuator to up, down, right, and, left.
- Make sure the actuator can be inserted into the entry slot without any issue.

- Actuator can move 3.3mm (HS9Z-A1S and -A2S) / 2.6mm (HS9Z-A3S) from the mounting reference position without affecting the contact operation.

$$\left(\text{Deviation of actuator position} \right) + \left(\text{Deviation of door position} \right) \leq 3.3 / 2.6 \text{mm}$$

- When closing the door, the actuator is inserted and locked within approx. 3.8mm (HS9Z-A1S and -A2S) / 3.3mm (HS9Z-A3S) from the mounting reference position.

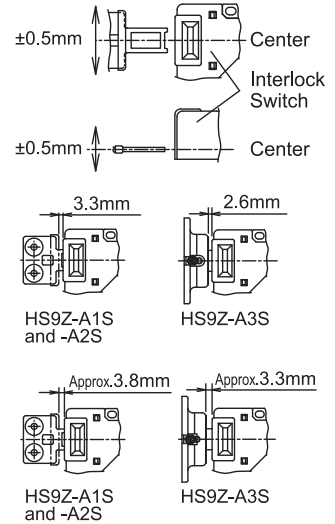

Recommended Screw Tightening Torque

	Screw Tightening Torque
For mounting the interlock switch (M5 screw) *6	3.2 to 3.8 N•m
For mounting the actuator HS9Z-A1S, HS9Z-A2S (M5 screw) *6 *7	2.7 to 3.3 N•m
HS9Z-A3S (M6 screw)	4.5 to 5.5 N•m
For mounting the lid (M4)	0.9 to 1.1 N•m
Terminal screw (M3)	0.6 to 0.8 N•m
Connector	2.7 to 3.3 N•m
Angle adjusting screw of HS9Z-A3S (M3 Hexagon Socket Head Screw)	0.8 N•m

CAUTION

*6 When the torque is not enough to recommended screw tightening torque, make sure that the screw do not become loose by using adhesive sealants etc. to keep right operation and mounting positioning.

- *7 When rubber cushions (and spacers) are not used, use M6 screws and tighten to a torque of 4.5 to 5.5 N•m.



Opening the Connector Hole

- Break a desired knockout to mount a connector using a hammer and a screwdriver.
- Remove the connector lock nut from inside the interlock switch before breaking the knockout to open a connector hole.
- When breaking the knockout to open a connector hole, be careful not to damage the internal contact block.

Note : Cracks or burrs on the connector hole will degrade the waterproof characteristics.

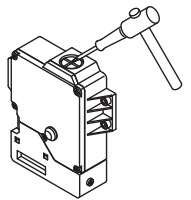

Adjusting the Angle Adjustable Actuator (HS9Z-A3S)

- Using the angle adjusting screw (M3 hexagon socket head screw), the actuator angle can be adjusted up to 20°.

- The larger the actuator angle, the smaller the applicable radius of the door swing. After installing the actuator, open the door. Then adjust the actuator angle so that the actuator enters the entry slot of the interlock switch properly.

- After adjusting the actuator angle, apply loctite or the like on the adjusting screw to prevent loosening.

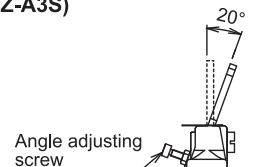

Installing the slot plug (In the case of a standard sale item. Please check other models.)

- When not in use, close up the interlock switch actuator entry slots with slot plugs to prevent dust from entering.
 - The actuator entry slot vertical to the mounting panel come closed up with slot plugs at time of shipment.
- When replacing, please use the tool as shown.

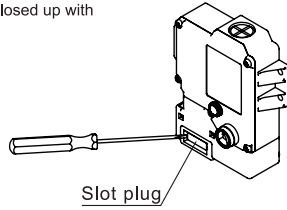

4 Instruction

Installation

- Do not apply an excessive shock to the interlock switch when opening or closing the door. A shock to the interlock switch exceeding 1,000 m/s² may cause failure.
- Provide a door guide, and ensure that force is applied on the interlock switch only in the actuator insertion direction.
- Do not pull the actuator while it is locked. Also, regardless of door types, do not use the interlock switch as a door lock. Install a separate lock as shown in section 3.
- When opening the interlock switch lid to wire, open the lid (A) only. (See the figure on the right.) Never remove other screws, otherwise the interlock switch may be damaged.
- The interlock switch cover can be only removed or installed with the special L-shaped wrench supplied with the interlock switch.
- Entry of foreign objects in the actuator entry slot may affect the mechanism of the interlock switch and cause a breakdown. If the operating atmosphere is contaminated, use a protective cover to prevent the entry of foreign objects into the interlock switch through the actuator entry slots.
- Avoid foreign objects such as dust, liquid and oil from entering the interlock switch while connecting a conduit or wiring.
- Make sure to install the product in a place where it cannot be damaged. Make sure to conduct a proper risk assessment evaluation before using the product, and use a shield or a cover to protect the product if need be.
- Continue for a long time energizing the solenoid, the switch temperature rises approximately 40°C above the ambient temperature (to approximately 95°C while the ambient temperature is 55°C). Keep hands off to prevent burns. Use heat-resistant wire when the solenoid touches wires.
- Use only the designated actuator for the HS1L. Other actuators will cause a breakdown of the interlock switch.
- Solenoid has polarity. Be sure to wire correctly.

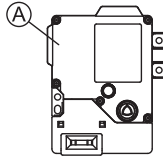

L-shaped wrench attached to the interlock switch
Type : HS9Z-T1



Opening / Closing the Cover (Type : HS1L-*K)

- To ensure safety, make sure that the power is turned off before opening or closing the cover.
- Do not touch the part (B) (shown in the figure on the below) with tools or fingers when opening the interlock switch cover. Otherwise the interlock switch may be damaged.
- Close the cover only as described below, otherwise failure of interlock switch will be caused.

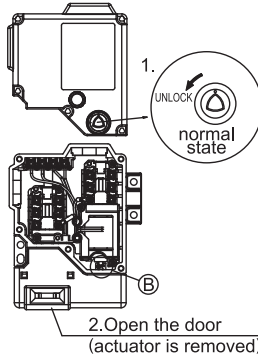

(Method)

1. Confirm that the manual unlock state on the cover is in "normal state".
2. Open the door (actuator is removed).
3. Close the cover, and tighten the screws to the appropriate torque.

WARNING

- Turn off the power to the interlock switch before starting installation, removal, wiring, maintenance, and inspection on the interlock switch. Failure to turn power off may cause electrical shocks or fire hazard.
- Do not disassemble or modify the switch. Also do not attempt to disable the interlock switch function, otherwise a breakdown or an accident will result.
- Use wires of a proper size to meet voltage and current requirements. Tighten the terminal screws to a recommended tightening torque of 0.9 to 1.1N·m. Loose terminal screws will cause unexpected heating and fire hazard during operation.

CAUTION

- HS1L Series Interlock Switches are Type 2 low-level coded interlocking devices (EN ISO / ISO14119). The following system installation & mounting instructions are EN ISO / ISO14119 requirements to prevent function failure from the interlock switch.
 1. Using permanent fixing methods (e.g. welding, rivets, special screws...etc) to prevent dismantling or de-positioning of the interlock device. However, permanent fixing methods are not an adequate solution if you expect the interlock device to fail during the machinery lifetime, or if you need to replace the product in quick manner. In these situations, other measures (see 2.) should be put in place to reduce the risks of function failure.
 2. At least one of the following measures should be applied to prevent function failure.
 - (1) Mounting the interlock device in a place out of reach from workers
 - (2) Using shielding protection to prevent physical obstruction of the device
 - (3) Mounting the interlock device in a hidden position
 - (4) Integrate status monitoring & cycling testing of the device to the control system to prevent product failure.
- Regardless of door types, do not use the interlock switch as a door stop. Install a mechanical door stop at the end of the door to protect the interlock switch against an excessive force.
- Do not install the actuator in the location where the human body may come into contact. Otherwise injury may occur.
- Pay attention to the management of spare actuator. Safety function of interlock switch will be lost in case the spare actuator is inserted into the interlock switch. Ensure that the actuator is firmly fastened to the door (welding, rivet, special screw) in the appropriate location, so that the actuator cannot be removed easily.
- Do not cut or remodel the actuator, otherwise failure will occur.
- Performance Level according to EN ISO 13849-1 is reduced with series connected safety components due to decreased fault recognition.
- The insulation of the cable has to withstand environmental influences.
- The overall concept of control system, into which the safety components has been integrated, must be validated in accordance with EN ISO 13849-2.

For Manual Unlocking

(Type HS1L-□4)

The HS1L allows manual unlocking of the key to precheck door operation before wiring or turning on power, as well as for emergency use such as a power failure.

(Type HS1L-□7Y)

In case the actuator is not unlocked when the solenoid is deenergized, the actuator can be unlocked manually.

(Unlocking Method)

- HS1L with manual unlock key :

To change the normal position to the manual unlocking position as shown on the right, turn the key fully (90 degrees) using the red plastic key included with the interlock switch.

Using the interlock switch with the key being not fully turned (less than 90 degrees) may cause damage to the interlock switch or errors.

(note: when manually unlocked, the interlock switch will keep the main circuit and the lock monitor circuit disconnected and the door unlocked.)

Do not attach the key to the interlock switch intentionally (the key is designed to fall off when the operator's hand is off the key).

In such case, interlock standards become unapplied because the interlock switch can be always unlocked during machine operation, and therefore will give hazardous conditions to workers.

- HS1L without manual unlock key

Remove the screw at the side of the interlock switch using the wrench for mounting the HS1L lid. Push the lever inside the interlock switch toward the pilot light using a small screwdriver until the actuator is unlocked. See the figure on the right. Screw Tightening Torque : 0.3 to 0.4Nm

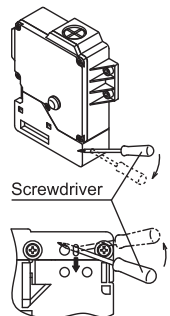

- Common

Insert a small screwdriver from the hole of the reverse side of the interlock switch. Push the pin inside the interlock switch toward the pilot light using a small screwdriver until the actuator is unlocked. See the figure on the right.

A hole for the lever should be opened on the mounting panel. When opening the hole, apply proper protection against water and other foreign objects.

CAUTION

- Before manually unlocking the interlock switch, make sure the machine has come to a complete stop. Manual unlocking during operation may unlock the interlock switch before the machine stops, and the function of interlock switch is lost.
- While the solenoid is energized, do not unlock the actuator manually (Solenoid lock type).

5 Contact Operation

Contact Configuration and Operating Characteristic

Type	Contact Configuration *9	Operating Characteristic (reference)
HS1L-R□		(Travel : mm) 0 (Actuator Mounting Reference Position) Approx.4.2 (Lock) Approx.7.0 Approx.10.0 Approx.30.0
		11-42
		21-22
		33-34
		51-52
HS1L-DQ□		11-42
		21-52
		33-34
		63-64
		61-62
HS1L-DT□		11-42
		21-52
		31-32
		61-62
		61-62
HS1L-VR□		11-12
		21-22
		33-34
		41-42
		51-52
HS1L-VQ□		11-12
		21-22
		33-34
		41-42
		63-64
HS1L-VT□		11-12
		21-22
		31-32
		41-42
		61-62

CAUTION

*8 This locking monitoring marking has been newly described in section 9.2.1 of EN ISO / ISO14119. It indicates that any devices with this marking meet the following EN ISO / ISO 14119 requirements:

- General (- General requirements for guard locking devices) (Section 5.7.1) *
- Locking monitoring (- Locking monitoring for guard locking devices) (Section 5.7.2.2)

When a lock monitor circuit (contact) has the locking monitoring marking, it means that one circuit (contact) can monitor the position and the locking function of the protective door. (The locking monitoring circuit (contact) turns ON only when the protective door is closed and locked.)

*note Both types of HS1L interlock switches - spring lock type switches and solenoid lock type switches - have obtained the locking monitoring certification marking. Based on risk assessment results, solenoid lock type switches can be used only for limited applications which do not especially need to be locked for safety.

*9 The Actuator is inserted, and HS1L is locked.

- Contact operation is based on the condition that the actuator is inserted into the center of the interlock switch slot.
- Contact operation shows the HS9Z-A1S, A2S, A3S actuator.
- Use main circuit or monitor circuit with for the input to interlock circuit.

Operation Cycle

(HS1L-□)		Closed	Closed	Open	Closed
Door States					
Manual Unlock Key		-	-	-	Turn the key to unlock position
Main Circuit	11-42 21-52	Closed	Open	Open	Open
Monitor Circuit	21-22 31-32	Closed	Closed	Open	Closed
Monitor Circuit	33-34	Open	Open	Closed	Open
Monitor Circuit	51-52 61-62	Closed	Open	Open	Open
Monitor Circuit	63-64	Open	Closed	Closed	Closed
Spring Lock Type (HS1L-□4)		Off	On	Off / On	Off
Solenoid Power	A1-A2				
Solenoid Lock Type (HS1L-□7Y)		On	Off	Off / On *11	Off *10 *11
Solenoid Power	A1-A2				
		•Door is locked. •The machine can be operated.	•Door is unlocked. •The machine can not be operated.	•The machine can not be operated.	•Door is unlocked. •The machine can not be operated.

(HS1L-V□)

(HS1L-V□)		Closed	Closed	Open	Closed
Door States					
Manual Unlock Key		-	-	-	Turn the key to unlock position
Monitor Circuit	11-12 21-22 31-32	Closed	Closed	Open	Closed
Monitor Circuit	33-34	Open	Open	Closed	Open
Monitor Circuit	41-42 51-52 61-62	Closed	Open	Open	Open
Monitor Circuit	63-64	Open	Closed	Closed	Closed
Spring Lock Type (HS1L-□4)		Off	On	Off / On	Off
Solenoid Power	A1-A2				
Solenoid Lock Type (HS1L-□7Y)		On	Off	Off / On *11	Off *10 *11
Solenoid Power	A1-A2				
		•Door is locked. •The machine can be operated.	•Door is unlocked. •The machine can not be operated.	•The machine can not be operated.	•Door is unlocked. •The machine can not be operated.

CAUTION

- *10 Do not attempt manual unlocking when the solenoid is energized.
- *11 Do not energize the solenoid for a long time while the door is open or when the door is unlocked manually.

6 Wiring

Wire Length inside the Interlock Switch

	Screw Terminal No.	Through Conduit Port	
		①	②
Wire Length: L1(mm)	11	95±2	45±2
	21	85±2	35±2
	22	60±2	70±2
	31/33	75±2	35±2
	32/34	50±2	60±2
	42	65±2	95±2
	51	45±2	70±2
	52	55±2	85±2
	61/63	35±2	60±2
	62/64	45±2	75±2
	A1	50±2	45±2
	A2	60±2	40±2
	X1	70±2	35±2
	X2	80±2	35±2
Wire Stripping Length: L2(mm)		7±1	

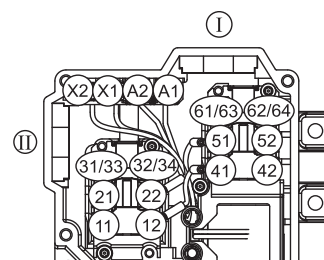

* Do not remove the wires of the terminals 12-41 and 22-51, because these terminals are interconnected in factory for safety circuit inputs. Use terminals 11-42 or 21-52 for safety circuit inputs.

(HS1L-V□)

	Screw Terminal No.	Through Conduit Port	
		①	②
Wire Length: L1(mm)	11	95±2	45±2
	12	80±2	80±2
	21	85±2	35±2
	22	60±2	70±2
	31/33	75±2	35±2
	32/34	50±2	60±2
	41	55±2	80±2
	42	65±2	95±2
	51	45±2	70±2
	52	55±2	85±2
	61/63	35±2	60±2
	62/64	45±2	75±2
	A1	50±2	45±2
	A2	60±2	40±2
X1	70±2	35±2	
X2	80±2	35±2	
Wire Stripping Length: L2(mm)		7±1	

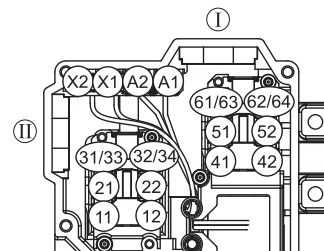

Recommended Wire Core Size

: 0.5 to 1.5 mm

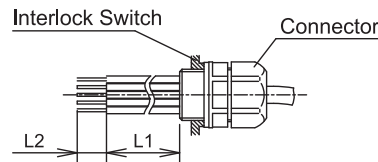

Applicable Crimping Terminal

- N0.5-3 / FN0.5 (made by JST) : Applicable wire core size 0.2 to 0.5mm²
- N1.25-MS3 (made by JST) : Applicable wire core size 0.25 to 1.65mm²
- V1.25-YS3A (made by JST) : Applicable wire core size 0.25 to 1.65mm²

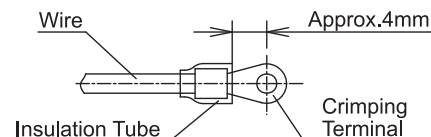
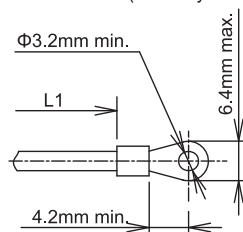

Note: Make sure to use an insulation tube on the crimping terminal.

Applicable Connectors

Use a connector with a degree of protection IP67.
Applicable connector dimensions: See the figure on the right.

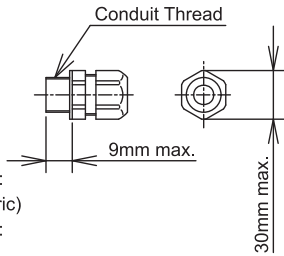

- When using plastic connector, metal connector and multi-core cable

(G1/2) Applicable Plastic Connector Example : Type SCS-10□ (made by Seiwa Electric)
Applicable Metal Connector Example : Type C20G-□□16 (made by SANKEI MANUFACTURING)

(PG13.5) Applicable Plastic Connector Example : Type ST13.5(made by LAPP)
Applicable Metal Connector Example : Type PBA13.5-□□ (made by AVC Cor.of JAPAN)

(M20) Applicable Plastic Connector Example : Type ST-M20×1.5(made by LAPP)
Applicable Metal Connector Example : Type C20M-□□20 (made by SANKEI MANUFACTURING)

Note :
Confirm the outside diameter of the multi-core cable, the connector type depends on the outside diameter of multi-core cable.

Note :
When using ST-M20×1.5, use with gasket GP-M (Type No: GPM20, made by LAPP).

7 Example of wiring Diagram realizing Interlock Category

Example of a circuit diagram for Safety Category 3 (attainable PL = d)

(Condition 1: To apply the fault exclusion of mechanical structural parts including the actuator → Make sure to use the product within the product specification range described in this manual and the version of the manual provided with the product.)
(Condition 2: Documentation of the reason for the machine/equipment manufacturer to have applied the fault exclusion based on ISO13849-1, ISO13849-2 or IEC62061.)

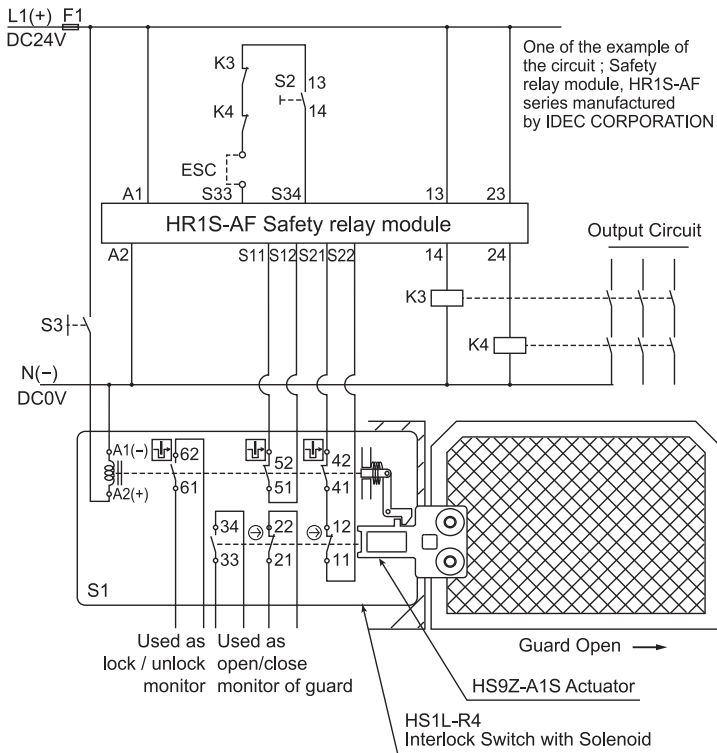

Example of a circuit diagram for Safety Category 4 (attainable PL = e)

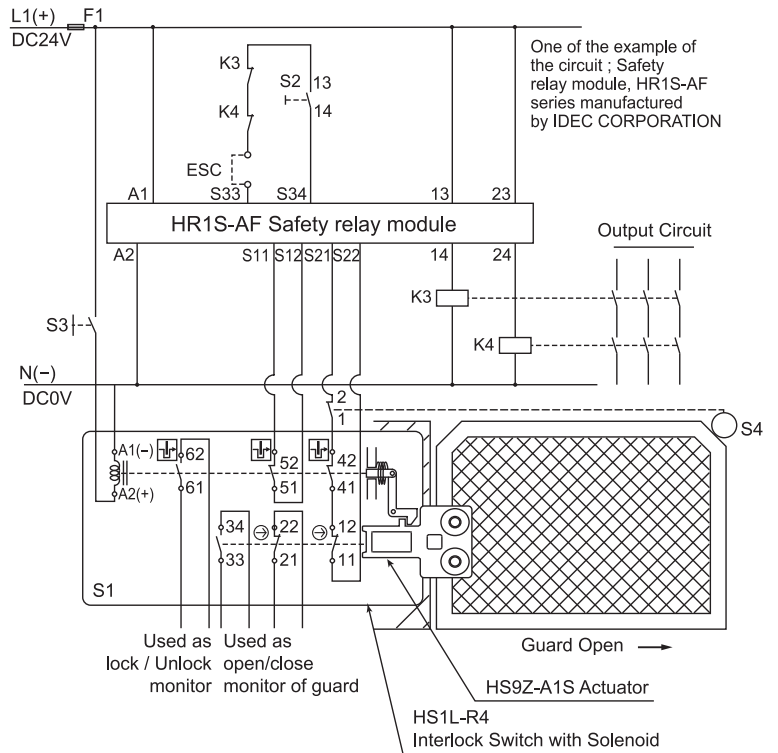

- S1: HS1L-R4 Interlock Switch with Solenoid
- S2: Start Switch (HW Series Momentary)
- S3: Unlocking Enabling Switch
- S4: Safety limit Switch
- ESC: Outside start condition
- K3, 4: Safety Contactor
- F1: Outside fuse of interlock relay module at power supply line

Note: Use the monitoring device(Safety relay module) provided the capability to detect a cross short circuit. The insulation of the cable has to withstand environmental influences. If a control device other than the one shown in the draft is used, the used control device has to be equipped with a cross short circuit monitor.

8 Dimensions (mm)

Interlock Switch dimensions

RP: Actuator mounting reference position

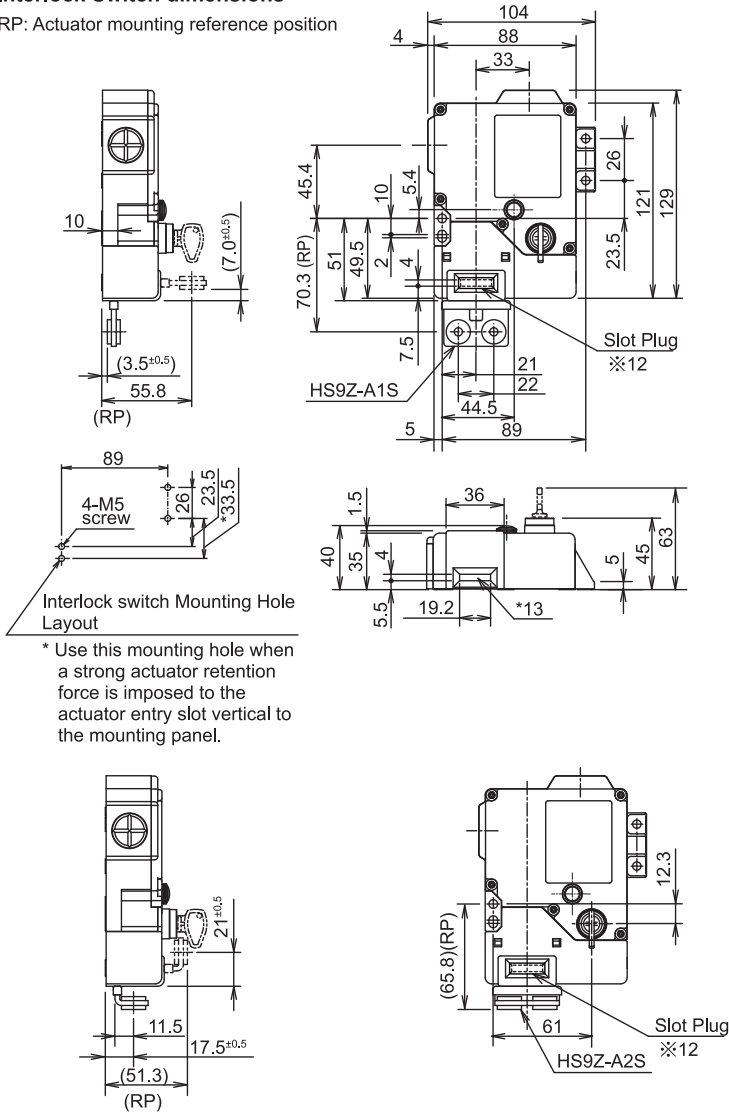

Accessories dimensions

Type : HS9Z-A1S

Type : HS9Z-A2S

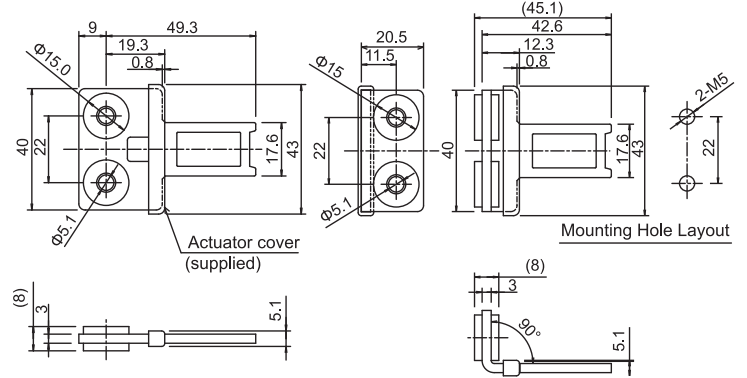

Type : HS9Z-A3S

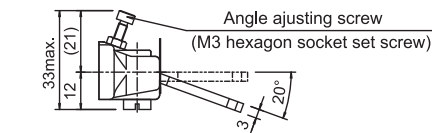
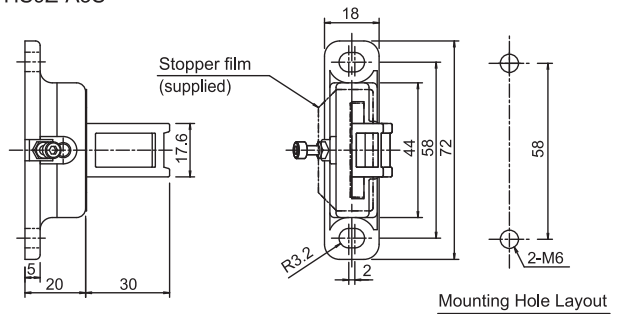

9 Precaution for Disposal

Dispose of the HS1L interlock switch as an industrial waste.

*12 The actuator entry slot vertical to the mounting panel

*13 The actuator entry slot horizontal to the mounting panel

Note: When not in use, close up the interlock switch actuator entry slots with slot plugs to prevent dust from entering.

(The actuator entry slot vertical to the mounting panel come closed up with slot plugs at time of shipment. In the case of a standard sale item. Please check other models.)

Note: When the actuator entry slot vertical to the mounting panel is used : Install the interlock switch on the panel using four mounting screws.

When the actuator entry slot horizontal to the mounting panel is used : Install the interlock switch on the panel using three mounting screws.

IDEC CORPORATION

<http://www.idec.com>

Manufacturer: IDEC CORP.

2-6-64 Nishimiyahara Yodogawa-ku, Osaka 532-0004, Japan

EU Authorized Representative: APEM SAS

55, Avenue Edouard Herriot BP1, 82303 Caussade Cedex, France

EU DECLARATION OF CONFORMITY

We, IDEC CORPORATION 2-6-64, Nishimiyahara Yodogawa-ku, Osaka 532-0004, Japan declare under our sole responsibility that the product:

Description: Interlock Switch

Model No: HS1L

Applied Union harmonized legislation and references to the relevant harmonization standards used or references the other technical specifications in relation to which conformity is declared.

Applicable EU Directive : Low Voltage Directive (2014/35/EU)

Machinery Directive (2006/42/EC)

RoHS Directive (2011/65/EU)

Applicable Standard(s) : EN 60947-5-1, GS-ET-15, EN 50581