



Miniature Photoelectric Sensors
(Built-in Amplifier)/Laser Model
SA2E/SA1E/SA1E-L



Miniature High-Performance Photoelectric Sensors

Enhanced detection accuracy and response time



IDEC CORPORATION

Choose according to sensing methods, sensing

Through-beam



Background Suppression

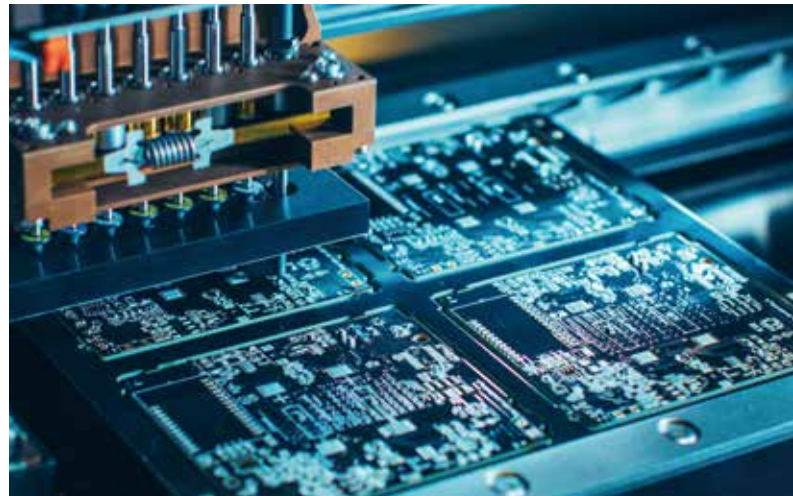

NEW



NEW



Sensing Method	Through-beam		Retro-reflective		
			Polarized Retro-reflective		Coaxial Polarized Retro-reflective (Transparent object sensing)
Part No.	SA2E-T	SA1E-LT	SA2E-P	SA1E-LP	SA1E-X
Sensing Range	20m	30m	5m (Depends on the reflector)	10m	2m (Depends on the reflector)
Light Source Element	Red LED	Red laser	Red LED	Red laser	Red LED
Detectable Object	Opaque (*1)	ø6mm (opaque, at 3m) (*1)	Opaque (*1)	ø6mm opaque (opaque, at 3 m) (*1)	Opaque/Mirror/ Transparent (*1)
Response Time	0.5ms	0.25ms	0.5ms	0.25ms	0.5ms
Sensitivity Adjustment/ Sensing Range Adjustment (BGS only)	Single-turn control (approx. 240°)				
Operation Mode	Light ON/Dark ON (select by model)	Light ON/Dark ON (selectable) (select using the Operation Mode Switch)			Light ON/Dark ON (select by model)
Control Output	NPN/PNP open collector				
Current Draw (Power Voltage 12 to 24V DC)	Projector: 20mA maximum Receiver: 20mA maximum	Projector: 15mA maximum Receiver: 30mA maximum	20mA maximum	35mA maximum	20mA maximum
Degree of Protection	IP67				
Operating Temperature (no freezing)	-30 to +55°C	-10 to +55°C	-30 to +55°C	-10 to +55°C	-25 to +55°C
Dimensions	w10.8 × D19.5 × H31.5 (excluding LEDs and controls)				

*1: Be sure to check the operation before use.

Diffuse-reflective



Small-beam Reflective



NEW



NEW



NEW



NEW



NEW



Reflective					
Background Suppression (BGS)		Diffuse-reflective			Small-beam Reflective
SA2E-B	SA1E-LB	SA2E-D			SA2E-N
10 to 350mm <small>Adjustable sensing range 20 to 350mm</small>	20 to 300mm <small>Adjustable sensing range 40 to 300mm</small>	100mm	500mm	1m	50 to 150mm
Red LED	Red laser	Infrared LED	Red LED	Infrared LED	Red LED
Opaque (*1)	∅0.2mm <small>(copper wire, at 170mm) (*1)</small>	Opaque/Transparent (*1)			Opaque/Transparent (*1)
0.5 ms	0.25ms	0.5 ms			0.5 ms
Approx. 7-turn endless control	6-turn endless control	Single-turn control (approx. 240°)			
Light ON/Dark ON (selectable) <small>(select using the Operation Mode Switch)</small>					
NPN open collector or PNP open collector					
20mA maximum	35mA maximum	20mA maximum			20mA maximum
IP67					
-30 to +55°C	-10 to +55°C	-30 to +55°C			-30 to +55°C
w10.8 × D19.5 × H31.5 (excluding LEDs and controls)					

Sensing range variations

SA2E SA1E SA1E-L

Through-beam

SA2E SA1E-L



Polarized Retro-reflective

SA2E SA1E-L

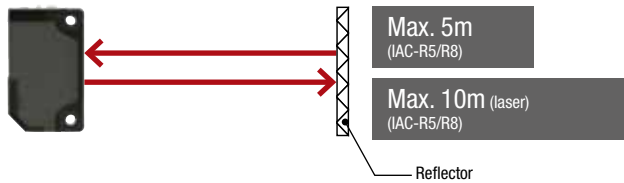

Coaxial Polarized Retro-reflective

SA1E

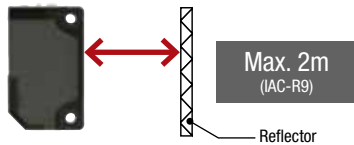

Diffuse reflective

SA2E

Three sensing variations according to distance are available.

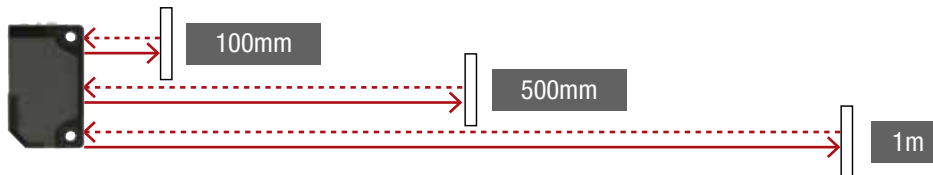

Background Suppression

SA2E SA1E-L

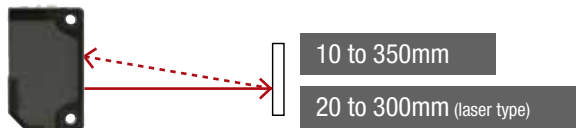

Small-beam

SA2E

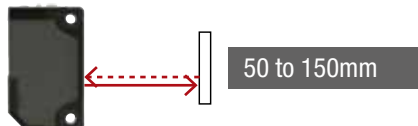

0.5ms response time, high-speed detection

SA2E

Small objects moving at high speed were detected at intervals, but with SA2E, the response time is 0.5ms, allowing continuous detection of small objects at high speed.



Beam diameter enables accurate detection of various objects (BGS)

SA2E-B Background Suppression (BGS)

By reducing the light beam diameter by 30 to 40% compared to conventional photoelectric sensors, the accuracy of the detecting position is improved.

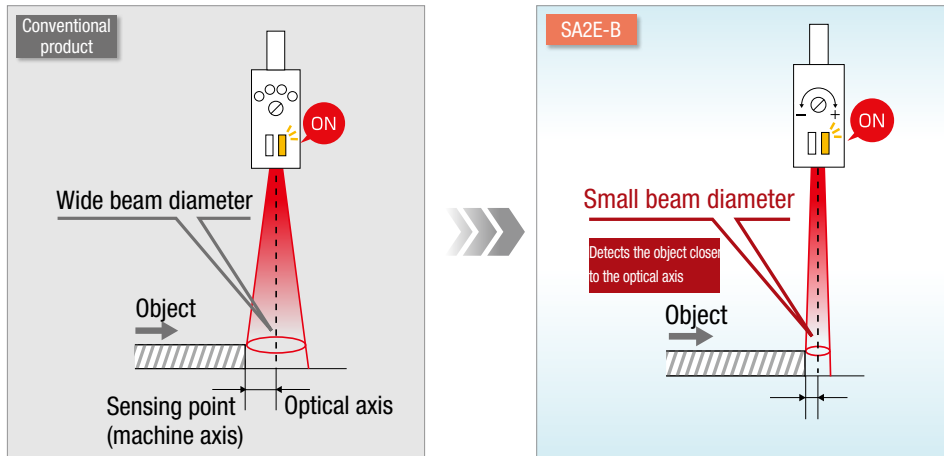

Air blower unit allows stable detection in dusty environment

SA2E SA1E SA1E-L

IDEAC's unique air blower unit mounting bracket is available as an option. Maintains detection performance of the sensor and keeps the detection surface clean.



Designed to blow air over the entire lens at the optimum pressure

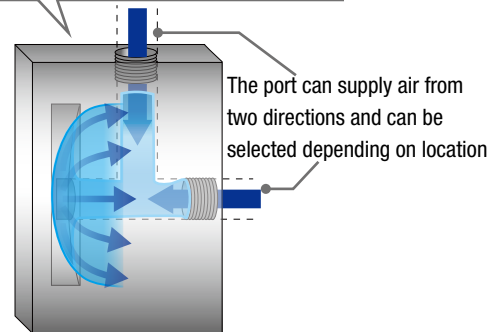

Operational at a temperature of -30 to 55°C

SA2E

Features operating temperature range of -30 to +55°C. Ideal for installation on equipment used in cold storage warehouses.



Output reverse-polarity protection circuit

SA2E

In addition to reverse-polarity protection for the power voltage, an output reverse-polarity protection circuit is also built-in, to protect the sensor from damage in the event of incorrect wiring.

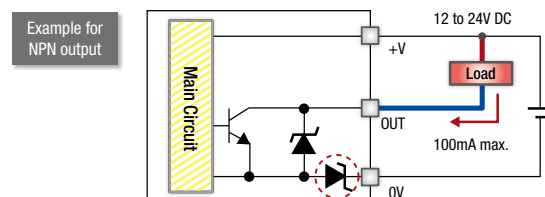

The built-in reverse-polarity protection diode prevents damage even if the wiring is incorrect.

Sensors available to suit a variety of workpieces

Background Suppression (BGS)

SA2E-B Background Suppression (BGS)

Ignores background and reliably detects workpieces. Not easily affected by the color of the workpiece and edges can be accurately detected by narrow beams. Detailed setting of distances is possible.

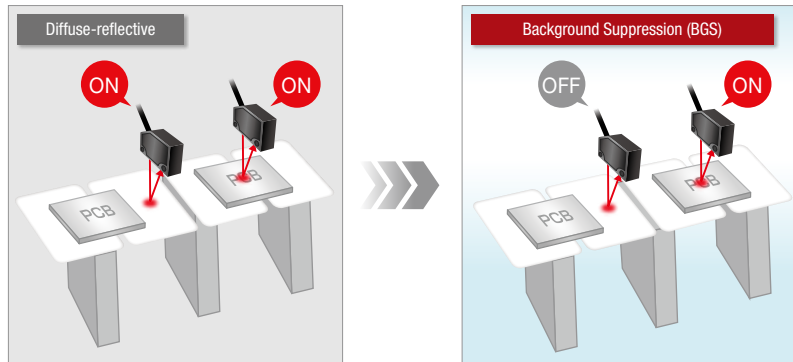

Coaxial Polarized Retro-reflective (Transparent object sensing)

SA1E-X Coaxial Polarized Retro-reflective Transparent Object Sensing

I Detects transparent objects of various shapes
Coaxial optical structure and narrow beam ensure stable detection; unaffected by narrowing, inclination or shaking of transparent objects.

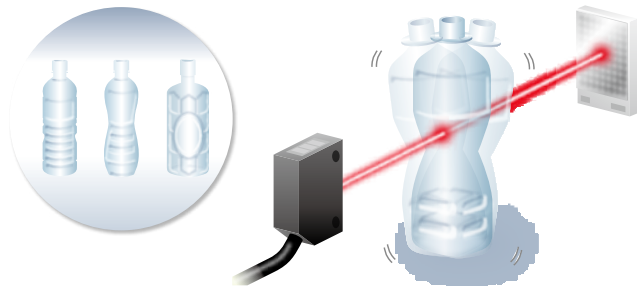

Application examples of transparent object sensing

Because of its coaxial structure, SA1E-X does not have a blind zone, such as shown below. Other than detecting transparent objects, because the workpiece can be detected closely to the sensor, SA1E-X can be used in applications in narrow installation locations and where objects are near the sensor.

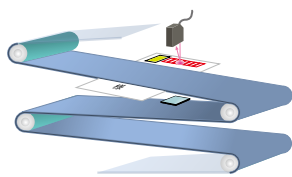

Mail sorting machine



Application examples

SA2E

SA1E

Through-beam

Automated parking garage

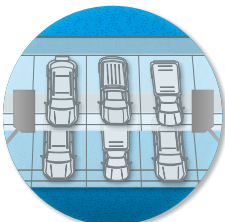

Polarized Retro-reflective

Detection of mirror surfaces

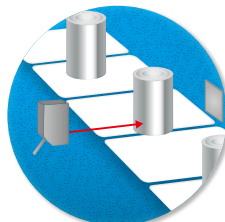

Diffuse-reflective

Restroom sink



Background Suppression (BGS)

Detecting PC board at inspections

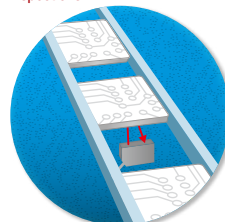

Coaxial Polarized Retro-reflective (Transparent Object Sensing)

Detecting the end of a transparent film

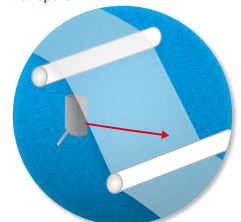

Laser models ensure fast response and accurate sensing

SA1E-L

Easy-to-align optical axis

IDEC's unique optical lens adjust function achieves easy and speedy optical adjustment when installing machines and equipment. Simple and accurate set up of long distance and small workpiece reading.

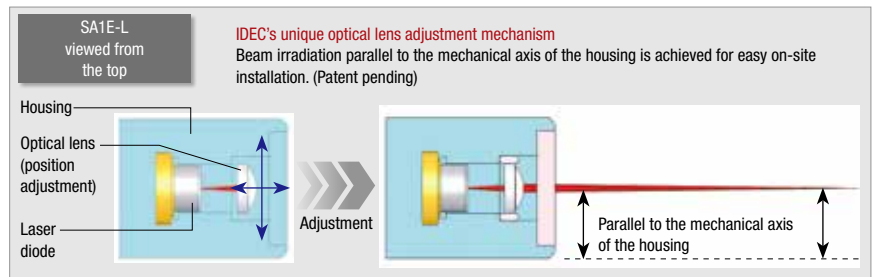

Detects fast-moving objects

The fast 0.25ms response speed allows reliable detection of closely spaced objects on a fast-moving conveyor.

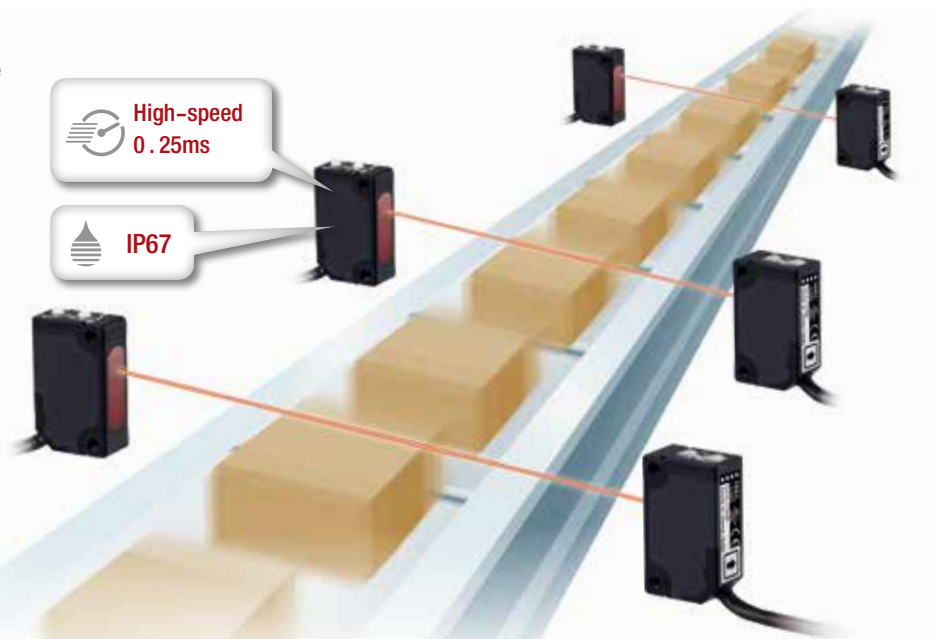

Dust and water resistant

IP67 protection suitable for environments exposed to dust or water vapor.

Easy positioning

Because the visible red laser is easily seen in both short (20mm) and long (30m) distances, the detecting position and optical axis can be seen at a glance. The small beam can detect small objects, and also enables easy positioning of the sensor in applications where the beam passes through narrow spaces. All models are Class 1 laser compliant (JIS, IEC, FDA).

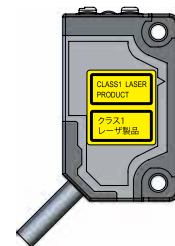

Application examples

SA1E-L

Detection from narrow locations



Detection of narrow gaps between objects on high-speed lines



Long distance detection

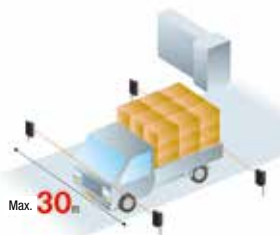

Detection in dust or water vapor



Detection of small objects

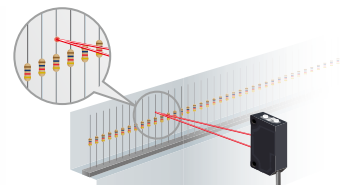







Miniature Photoelectric Sensors (Built-in Amplifier)/Laser Model

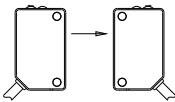

See website for details on approvals and standards.

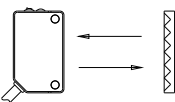
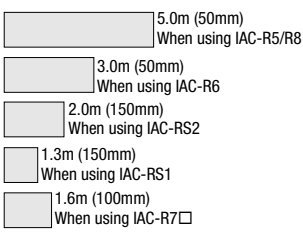
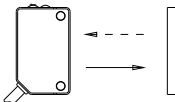
SA2E/SA1E

Package Quantity: 1

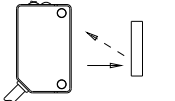
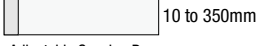
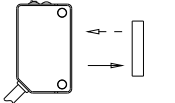
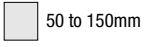
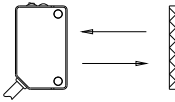
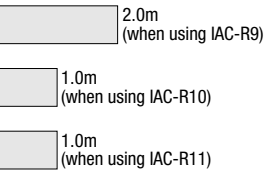
Sensing Method		Sensing Range	Connection	Cable Length (m)	Operation Mode	Part No.			
						NPN Output	PNP Output		
Through-beam	With Sensitivity Adjustment Red LED	  20m * See the characteristics on P18.	Cable	2	Select Light ON/ Dark ON	SA2E-TN3-2M	SA2E-TP3-2M		
			Connector	—		SA2E-TN3C	SA2E-TP3C		
Polarized Retro-reflective	With Sensitivity Adjustment Red LED	 (*1) (*2)  5.0m (50mm) When using IAC-R5/R8 3.0m (50mm) When using IAC-R6 2.0m (150mm) When using IAC-RS2 1.3m (150mm) When using IAC-RS1 1.6m (100mm) When using IAC-R7□ * See the characteristics on P19.	Cable	2	Select Light ON/ Dark ON	SA2E-PN3-2M	SA2E-PP3-2M		
			Connector	—		SA2E-PN3C	SA2E-PP3C		
Diffuse-reflective	With Sensitivity Adjustment Red LED	  1m * See the characteristics on P19.	Cable	2	Select Light ON/ Dark ON	SA2E-DN3L-2M	SA2E-DP3L-2M		
			Connector	—		SA2E-DN3LC	SA2E-DP3LC		
			 500mm * See the characteristics on P19.	Cable		2	SA2E-DN3M-2M	SA2E-DP3M-2M	
				Connector		—	SA2E-DN3MC	SA2E-DP3MC	
				 100mm * See the characteristics on P19.		Cable	2	SA2E-DN3S-2M	SA2E-DP3S-2M
						Connector	—	SA2E-DN3SC	SA2E-DP3SC
Background Suppression (BGS)	With Sensing Range Adjustment Red LED	  10 to 350mm Adjustable Sensing Range 20 to 350mm * See the characteristics on P20.	Cable	2	Select Light ON/ Dark ON	SA2E-BN3-2M	SA2E-BP3-2M		
			Connector	—		SA2E-BN3C	SA2E-BP3C		
Small-beam Reflective	With Sensitivity Adjustment Red LED	  50 to 150mm * See the characteristics on P19.	Cable	2	Select Light ON/ Dark ON	SA2E-NN3-2M	SA2E-NP3-2M		
			Connector	—		SA2E-NN3C	SA2E-NP3C		
Coaxial Polarized Retro-reflective (Transparent Object Sensing)	With Sensitivity Adjustment Red LED	 (*1)  2.0m (when using IAC-R9) 1.0m (when using IAC-R10) 1.0m (when using IAC-R11) * See the characteristics on P20.	Cable	1	Light ON	SA1E-XN1	SA1E-XP1		
					Dark ON	SA1E-XN2	SA1E-XP2		
				2	Light ON	SA1E-XN1-2M	SA1E-XP1-2M		
					Dark ON	SA1E-XN2-2M	SA1E-XP2-2M		
				5	Light ON	SA1E-XN1-5M	SA1E-XP1-5M		
					Dark ON	SA1E-XN2-5M	SA1E-XP2-5M		
Connector	Light ON	SA1E-XN1C	SA1E-XP1C						
	Dark ON	SA1E-XN2C	SA1E-XP2C						

*1: Maintain at least the distance shown in the () between the photoelectric switch and reflector.



*2: Reflectors are not supplied and must be ordered separately.

• Through beam SA2E-T models are engraved with SA2E-T*3P (projector) and SA2E-T*3R (receiver) for identification.

SA1E-L

Part No.

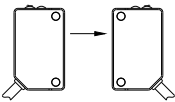
Package Quantity: 1

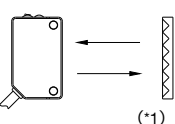
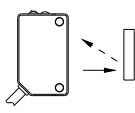
Sensing Method			Sensing Range	Connection	Cable Length (m)	Part No.	
						NPN Output	PNP Output
Through-beam	Red laser	w/Sensitivity Adjustment 	 30m * See the characteristics on P21.	Cable	1	SA1E-LTN3	SA1E-LTP3
					2	SA1E-LTN3-2M	SA1E-LTP3-2M
					5	SA1E-LTN3-5M	SA1E-LTP3-5M
				Connector	—	SA1E-LTN3C	SA1E-LTP3C
Polarized Retro-reflective	Red laser	w/Sensitivity Adjustment  (*1)	10m (300mm) When using IAC-R5/R8 10m (300mm) When using IAC-R9 * See the characteristics on P21.	Cable	1	SA1E-LPN3	SA1E-LPP3
					2	SA1E-LPN3-2M	SA1E-LPP3-2M
					5	SA1E-LPN3-5M	SA1E-LPP3-5M
				Connector	—	SA1E-LPN3C	SA1E-LPP3C
Background Suppression (BgS)	Red laser	w/Sensing Range Adjustment 	20 to 300 mm Adjustable Sensing Range 40 to 300mm * See the characteristics on P22.	Cable	1	SA1E-LBN3	SA1E-LBP3
					2	SA1E-LBN3-2M	SA1E-LBP3-2M
					5	SA1E-LBN3-5M	SA1E-LBP3-5M
				Connector	—	SA1E-LBN3C	SA1E-LBP3C

*1: Maintain at least the distance shown in [] between the photoelectric switch and reflector. Reflectors are not supplied and must be ordered separately.

SA2E/SA1E
Specifications

	Through-beam	Polarized Retro-reflective
Part No.	SA2E-T□	SA2E-P□
Power Voltage	12 to 24V DC (Operating range: 10 to 30V DC) equipped with reverse-polarity protection	
Current Draw	Projector: 20mA maximum Receiver: 20mA maximum	20mA maximum
Sensing Range	20m	5.0 m (IAC-R5/R8) 3.0 m (IAC-R6) 2.0 m (IAC-RS2) 1.3 m (IAC-RS1) 1.6 m (IAC-R7□) (*1)
Adjustable Sensing Range	—	
Detectable Object	Opaque (*2)	
Hysteresis	—	20% maximum
Response Time	0.5ms maximum	0.5 ms maximum
Sensitivity Adjustment	Single-turn control (approx. 240°)	
Sensing Range Adjustment	—	
Light Source Element	Red LED	Red LED
Operation Mode	Light ON/Dark ON (select using the Operation Mode Switch)	
Control Output	NPN open collector or PNP open collector (30V DC, 100 mA maximum with short circuit protection circuit) Voltage drop: 2V max. (30V DC, 100mA) 1.2V max. (30V DC, 10mA) Output Reverse-polarity Protection Circuit	
LED Indicators	Operation LED: Amber Stable LED: Green, Power LED: Green (Through-beam type projector)	
Interference Prevention	—	Two units can be mounted in close proximity.
Degree of Protection	IP67 (IEC60529)	
Extraneous Light Immunity	Sunlight: 40,000 lux maximum, Incandescent lamp: 10,000 lux maximum (at receiver)	
Operating Temperature	-30 to +55°C (no freezing)	
Operating Humidity	35 to 95% RH (no condensation)	
Storage Temperature	-40 to +70°C (no freezing)	
Insulation Resistance	Between live part and mounting bracket: 20 MΩ minimum (500V DC megger)	
Dielectric Strength	1,000V AC, 50/60 Hz, 1 minute (between live part and mounting bracket)	
Vibration Resistance	10 to 55 Hz, amplitude 1.5mm 55 to 500 Hz, acceleration 90m/s ² 1 cycle 5 mins 30 mins in each of 3 axes	
Shock Resistance	1000m/s ² 3 shocks in 6 directions on 3 axes	
Material	Case	PBT
	Lens	PMMA
	Indicator Model	PC
Weight (approx.)	Cable Type	Projector: 50g, Receiver: 50g (*3)
	Connector Type	Projector: 10g, Receiver: 10g
Connection Method	Cable Type	ø3.5mm, 3-core (2-core for through-beam), 0.2mm ² , vinyl cabtyre cable
	Connector Type	M8 connector (4-pin)

*1: Maintain at least the distance shown below between the photoelectric switch and reflector.

IAC-R5/R6/R8: 50mm, IAC-R7: 100mm, IAC-RS1/RS2: 150mm

The detection distance cannot be guaranteed if the reflector is deformed or the reflector tape is applied on an uneven surface.

*2: Be sure to check the operation before use.

*3: Cable length: 2m (30g when the cable length is 1m. 110g when the cable length is 5m.)

SA2E/SA1E

Specifications

	Diffuse-reflective			Background Suppression (BGS)	Small-beam Reflective	Coaxial Polarized Retro-reflective (Transparent Object Sensing)
	Short Distance	Medium Distance	Long Distance			
Part No.	SA2E-D□3S	SA2E-D□3M	SA2E-D□3L	SA2E-B□	SA2E-N□	SA1E-X□
Power Voltage	12 to 24V DC (Operating range: 10 to 30V DC) equipped with reverse-polarity protection					
Current Draw	20mA maximum					
Sensing Range	100mm (using 200 × 200mm white paper)	500mm (using 200 × 200mm white paper)	1m (using 200 × 200mm white paper)	10 to 350mm (using 200 × 200mm white paper)	50 to 150mm (using 100 × 100mm white paper)	2m (using IAC-R9)
Adjustable Sensing Range	—			20 to 350mm (using 200 × 200mm white paper)	—	
Detectable Object	Opaque/transparent (*1)			Opaque (*1)	Opaque/transparent (*1)	Opaque/transparent/mirror (*1)
Hysteresis	20% maximum			5% maximum	20% maximum	—
Response Time	0.5ms maximum					
Sensitivity Adjustment	Adjustable using a control (approx. 240°)			—	Adjustable using a control (approx. 240°)	
Sensing Range Adjustment	—			Approx. 7-turn endless control	—	
Light Source Element	Infrared LED	Red LED	Infrared LED	Red LED		
Operation Mode	Light ON/Dark ON (selectable) (select with the Operation Mode Switch)					Light ON/Dark ON (select by Part No.)
Control Output	NPN open collector or PNP open collector (30V DC, 100mA maximum with short circuit protection circuit) Voltage drop: 2V max. (30V DC, 100mA) 1.2V max. (30V DC, 10mA) Output Reverse-polarity Protection Circuit					Voltage drop: 2V max. (30V DC, 100mA)
LED Indicators	Operation LED: Amber Stable LED: Green					Operation LED: Yellow
Interference Prevention	Two units can be mounted in close proximity.					
Degree of Protection	IP67 (IEC60529)					
Extraneous Light Immunity	Sunlight: 40,000 lux maximum, Incandescent lamp: 10,000 lux maximum (at receiver)					Sunlight: 10,000 lux maximum, Incandescent lamp: 5,000 lux maximum (at receiver)
Operating Temperature	-30 to +55°C (no freezing)					-25 to +55°C (no freezing)
Operating Humidity	35 to 95% RH (no condensation)					
Storage Temperature	-40 to +70°C (no freezing)					
Insulation Resistance	Between live part and mounting bracket: 20 MΩ minimum (500V DC megger)					
Dielectric Strength	1,000V AC, 50/60 Hz, 1 minute (between live part and mounting bracket)					
Vibration Resistance	10 to 55 Hz, amplitude 1.5mm 55 to 500 Hz, acceleration 90m/s ² 1 cycle 5 mins 30 mins in each of 3 axes					10 to 55 Hz, amplitude 1.5mm 1 cycle 5 mins 30 mins in each of 3 axes
Shock Resistance	1000m/s ² 3 shocks in 6 directions on 3 axes					500m/s ² 3 shocks in 6 directions on 3 axes
Material	Case	PBT				PC/PBT
	Lens	PMMA				
	Indicator Model	PC				
Weight (approx.)	Cable Type	50g				55g (*2)
	Connector Type	20g				20g
Connection Method	Cable Type	ø3.5mm, 3-core, 0.2mm ² , vinyl cabtyre cable				
	Connector Type	M8 connector (4-pin)				

*1: Be sure to check the operation before use.

*2: Cable length: 2m (35g when the cable length is 1m. 120g when the cable length is 5m.)

SA1E-L

Specifications

	Through-beam	Polarized Retro-reflective	Background Suppression (BGS)
Part No.	SA1E-LT□	SA1E-LP□	SA1E-LB□
Power Voltage	12 to 24V DC (Operating range: 10 to 30V DC) equipped with reverse-polarity protection		
Current Draw	Projector: 15mA maximum Receiver: 30mA maximum	35mA maximum	
Sensing Range	30m	0.3 to 10m (using IAC-R5/R8/R9)	20 to 300mm (using 100 × 100mm white paper)
Adjustable Sensing Range	—		40 to 300mm
Detectable Object Size (typical)	ø6mm minimum (opaque, at 3m)		ø0.2mm minimum (copper wire, at 170mm)
Detectable Object	Opaque (*1)		
Hysteresis	—		10% maximum
Response Time	0.25ms maximum		
Sensitivity Adjustment	Adjustable using a control		—
Sensing Range Adjustment	—		6-turn control knob
Light Source Element	Red laser diode (emission wavelength: 650nm) (IEC/JIS/FDA Class 1) (*2)		
Operation Mode	Light ON/Dark ON (selectable) (select with the Operation Mode Switch)		
Control Output	NPN open collector or PNP open collector (30V DC, 100mA maximum with short circuit protection circuit) Voltage drop: 1.5V max.		
LED Indicators	Operation LED: Yellow Stable LED: Green, Power LED: Green (Through-beam type projector only)		
Interference Prevention	—		Two units can be mounted in close proximity.
Degree of Protection	IP67 (IEC60529)		
Extraneous Light Immunity	Sunlight: 10,000 lux maximum, Incandescent lamp: 5,000 lux maximum (at receiver)		
Operating Temperature	-10 to +55°C (no freezing)		
Operating Humidity	35 to 85% RH (no condensation)		
Storage Temperature	-25 to +70°C (no freezing)		
Storage Humidity	35 to 85% RH (no condensation)		
Insulation Resistance	Between live part and mounting bracket: 20 MΩ minimum (500V DC megger)		
Dielectric Strength	Cable types: 1,000V AC, 50/60 Hz, 1 minute (between live part and mounting bracket) Connector types when connected with connector cable: 500V AC, 50/60 Hz, 1 minute (between live part and clamp ring)		
Vibration Resistance	10 to 55 Hz, amplitude 1.5mm 1 cycle 5 mins 30 mins in each of 3 axes		
Shock Resistance	500m/s ² 3 shocks in 6 directions on 3 axes		
Material	Housing: PBT, Lens: PMMA, Indicator cover: PC, knob: POM		
Weight (approx.)	Cable Type	35g (*3)	
	Connector Type	20g	
Connection Method	Cable Type	ø3.5mm, 3-core, 0.2mm ² , vinyl cabtyre cable	
	Connector Type	M8 connector (4-pin)	

*1: Be sure to check the operation before use.

*2: Compliant with Class 1 of FDA regulations (21 CFR 1040.10 and 21 CFR 1040.11 according to Laser Notice No. 50).

*3: Cable length: 1m (55g when the cable length is 2m. 120g when the cable length is 5m.)

SA2E/SA1E/SA1E-L

Slit and Sensing Range (typical) [Through-beam SA2E-T□]

Slit		With Sensitivity Adjustment			
Part No.	Slit Width: A (See P26.)	Sensing Range (m)		Minimum Detectable Object Width (mm) (*1)	
		Attached on: Receiver	Attached on: Receiver/Projector	Attached on: Receiver	Attached on: Receiver/Projector
SA9Z-S06	0.5mm	2.5	1.0	0.5	0.5
SA9Z-S07	1.0mm	3.5	1.5	1.0	1.0
SA9Z-S08	2.0mm	6.0	3.5	2.0	2.0
SA9Z-S09	0.5mm	2.0	0.7	0.5	0.5
SA9Z-S10	1.0mm	3.0	1.5	1.0	1.0
SA9Z-S11	2.0mm	5.5	3.0	2.0	2.0
SA9Z-S12	0.5mm	0.8	0.08	0.5	0.5
SA9Z-S13	1.0mm	1.5	0.3	1.0	1.0
SA9Z-S14	2.0mm	2.5	1.2	2.0	2.0

*1: At 1mm from receiver surface.

- The slit can be snapped onto the front easily. (See the figure below.)
- To order, see Ordering Part No. on page 23.

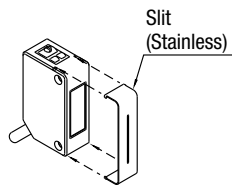

Horizontal slits and round slits have an orientation. Make sure that the TOP marking comes on top of the sensor (LED side).

Slit and Sensing Range (typical) [Through-beam SA1E-LT□]

Slit		Sensing Range (m)	Minimum Detectable Object Width (mm)
Part No.	Slit Width: A	Used on receiver	Used on receiver
SA9Z-S12	0.5mm	6	1.1
SA9Z-S13	1.0mm	10	1.6
SA9Z-S14	2.0mm	22	2.5

- When slit is mounted only on the receiver (when mounting on one side).
- Minimum detectable object width (mm): when the object is at the intermediate point between the projector and receiver.

The slit can be snapped onto the front easily.

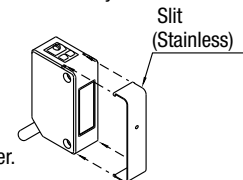

Dimensions

All dimensions in mm

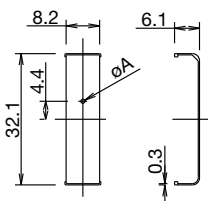

Material: Stainless Steel

The slits have an orientation. Make sure that the TOP marking comes on top of the sensor (LED side).

SA2E/SA1E/SA1E-L

Output Circuit & Wiring Diagram

SA2E

Through-beam, Polarized Retro-reflective, Diffuse-reflective, Background Suppression (BGS), Small-beam Reflective

NPN Output

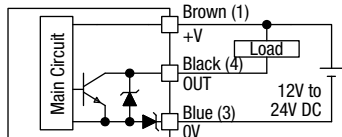

Connector Pin Assignment

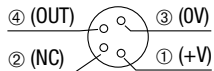

PNP Output

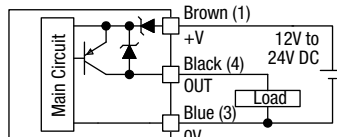

Connector Pin Assignment

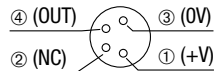

Through-beam Projector

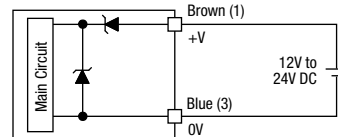

Connector Pin Assignment

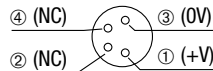

SA1E-X Coaxial Polarized Retro-reflective (Transparent Object Sensing)

NPN Output

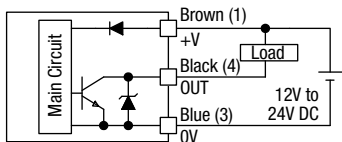

Connector Pin Assignment

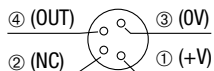

PNP Output

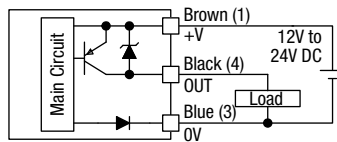

Connector Pin Assignment

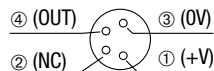

SA1E-L

NPN Output

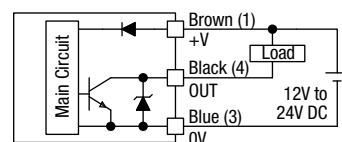

Connector Pin Assignment

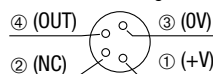

PNP Output

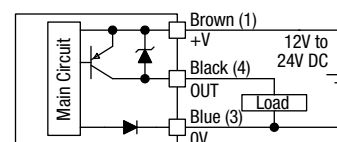

Connector Pin Assignment

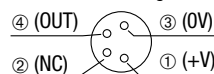

Through-beam Projector

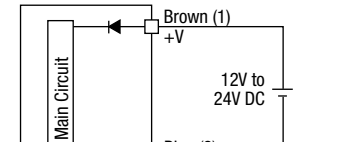

Connector Pin Assignment

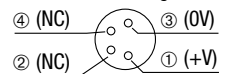

Dimensions (SA2E/SA1E)

All dimensions in mm.

Cable Type

Through-beam (SA2E-T)

Polarized Retro-reflective (SA2E-P)

Diffuse-reflective (SA2E-D)

Background Suppression (BGS) (SA2E-B)

Small-beam Reflective (SA2E-N)

*1: LED power indicator (green) for SA2E-T through-beam.

*2: The SA2E-T through-beam does not have a sensitivity control, operation mode switch, or stable LED.

*3: SA2E-B has a knob for setting sensing range (7-turn endless control).

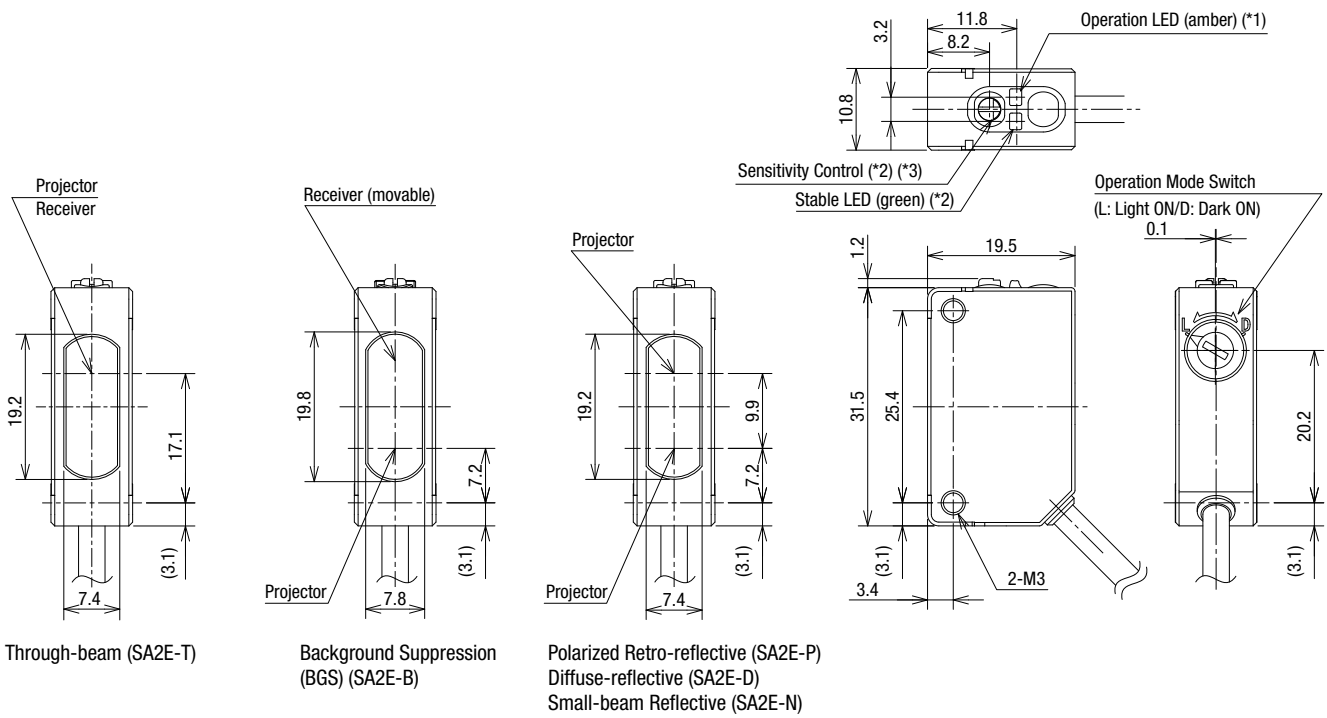

Coaxial Polarized Retro-reflective (Transparent Object Sensing) (SA1E-X)

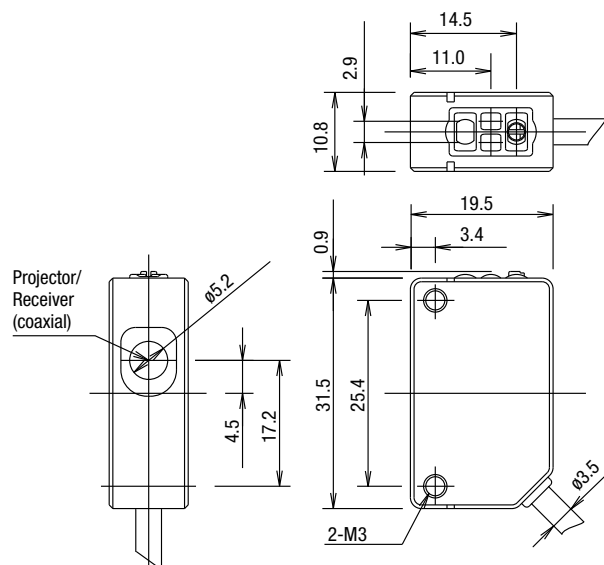

Dimensions (SA2E/SA1E)

All dimensions in mm.

Connector Type

Through-beam (SA2E-T)

Polarized Retro-reflective (SA2E-P)

Diffuse-reflective (SA2E-D)

Background Suppression (BGS) (SA2E-B)

Small-beam Reflective (SA2E-N)

*1: LED power indicator (green) for SA2E-T through-beam.

*2: The SA2E-T through-beam does not have a sensitivity control, operation mode switch, or stable LED.

*3: SA2E-B has a knob for setting sensing range (7-turn endless control).

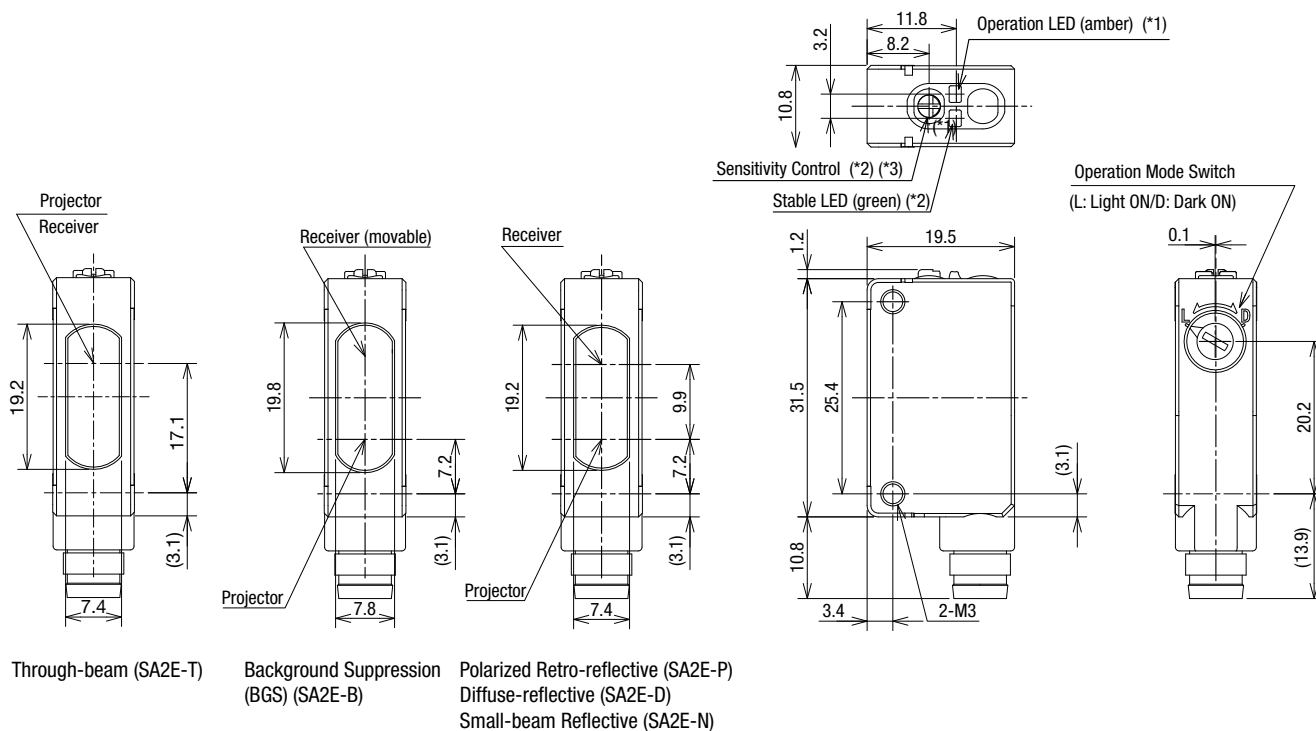

Coaxial Polarized Retro-reflective (Transparent Object Sensing) (SA1E-X)

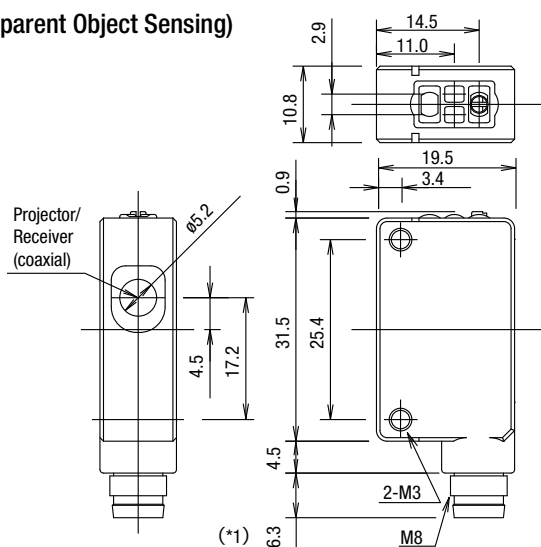

*1: The connector length is 18 mm when a right-angle connector cable (SA9Z-CM8K-4L□) is attached.

Dimensions (SA1E-L)

All dimensions in mm.

Cable Type

Through-beam Polarized retro-reflective
 Background suppression (BGS)

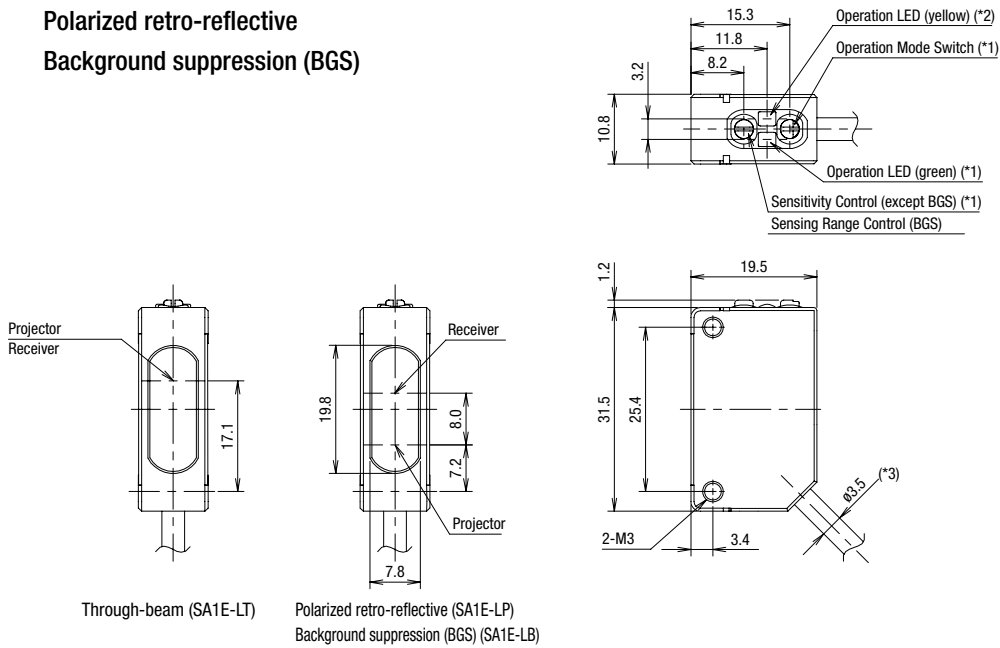

Connector Type

Through-beam Polarized retro-reflective
 Background suppression (BGS)

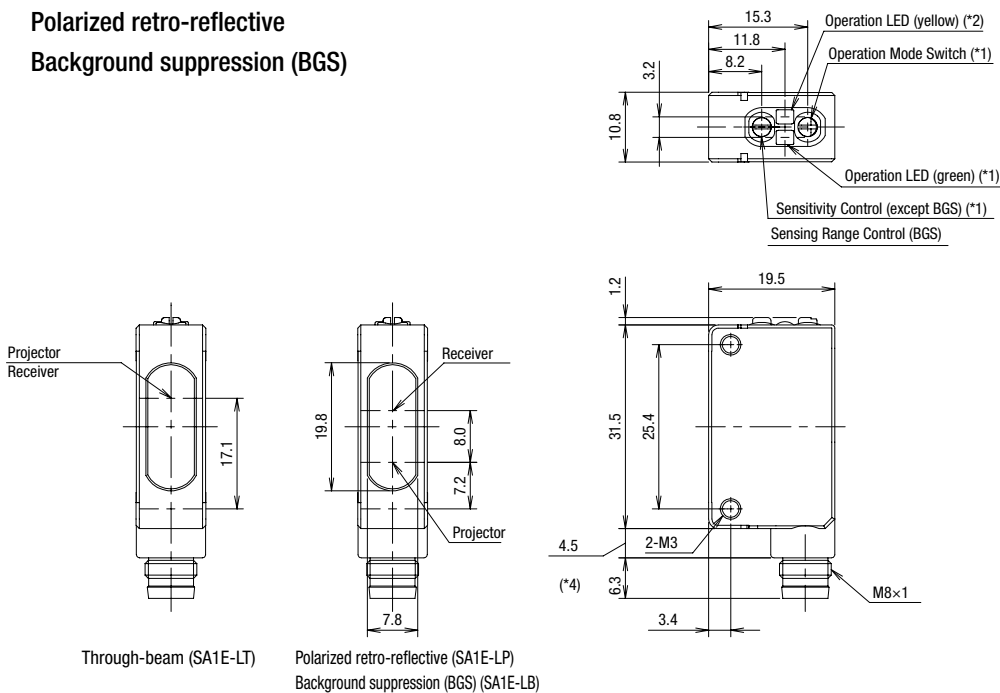

*1: No stable LED, sensitivity control, and operation mode switch are attached on the through-beam projector.
 *2: Power LED (green) for through-beam projector.
 *3: Cable length depends on models.
 *4: The connector length is 18mm when a right-angle connector cable (SA9Z-CM8K-4L□) is attached.

Characteristics (Typical) (SA2E)

(1) Through-beam SA2E-T□

Excess Gain vs. Sensing Distance (Without slit)

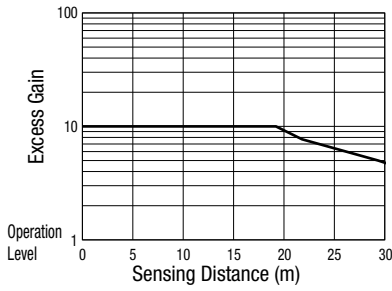

Lateral Displacement (Without slit)

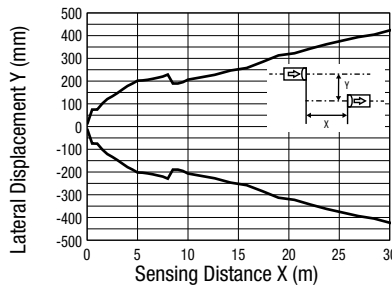

Angle (Without slit)

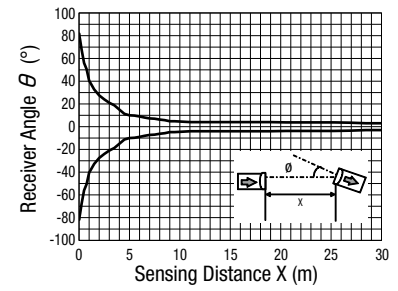

Excess Gain vs. Sensing Distance (With vertical slit)

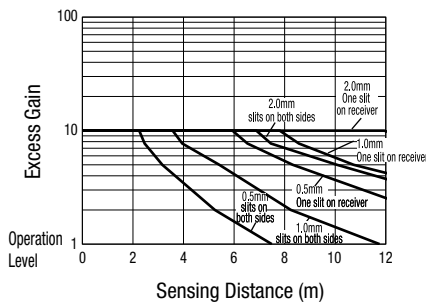

Excess Gain vs. Sensing Distance (With horizontal slit)

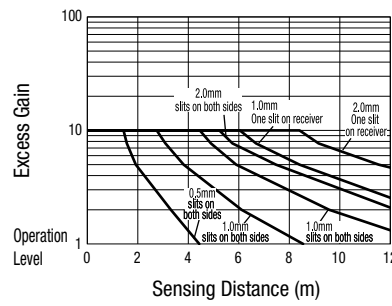

Excess Gain vs. Sensing Distance (With round slit)

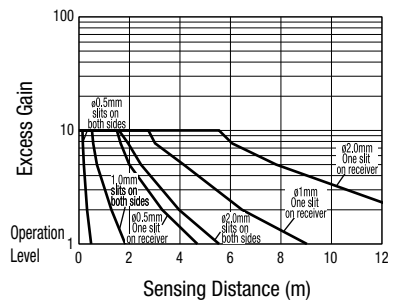

Lateral Displacement (With 0.5-mm vertical slit)

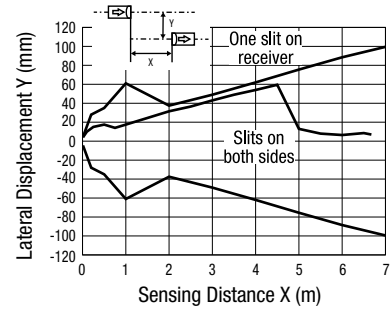

Lateral Displacement (With 1.0-mm vertical slit)

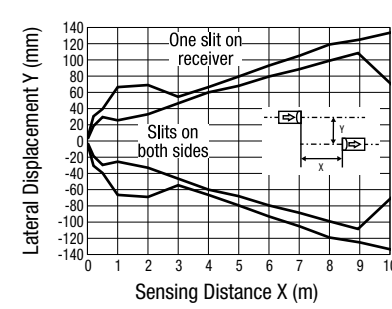

Lateral Displacement (With 2.0-mm vertical slit)

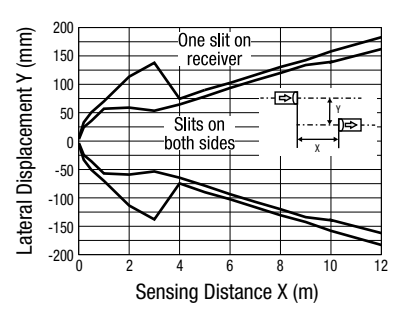

Lateral Displacement (With 0.5-mm horizontal slit)

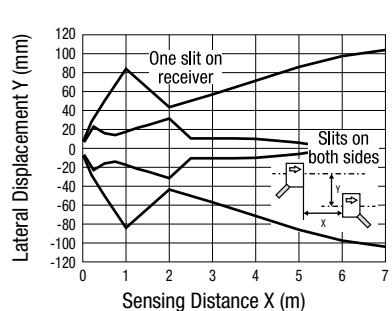

Lateral Displacement (With 1.0-mm horizontal slit)

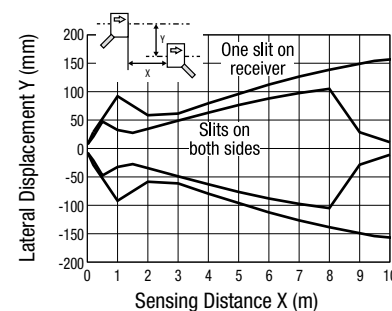

Lateral Displacement (With 2.0-mm horizontal slit)

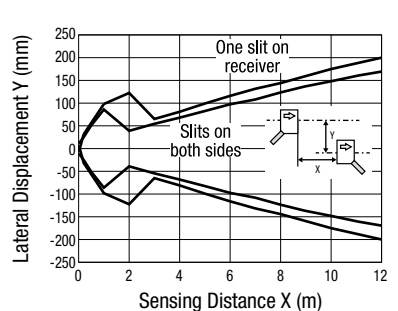

Lateral Displacement (With ø0.5-mm round slit)

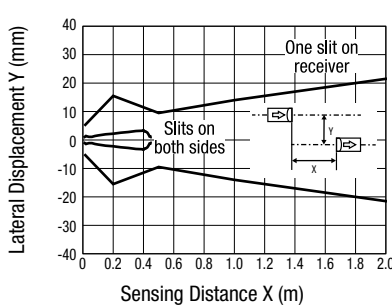

Lateral Displacement (With ø1.0-mm round slit)

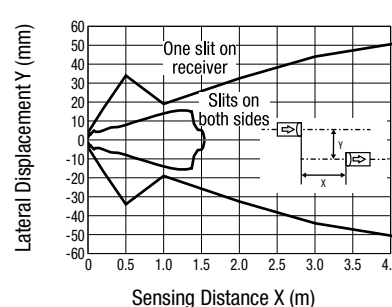

Lateral Displacement (With ø2.0-mm round slit)

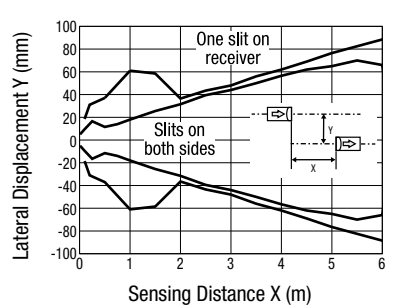

Characteristics (Typical) (SA2E)

(2) Polarized Retro-reflective SA2E-P□

Excess Gain vs. Sensing Distance

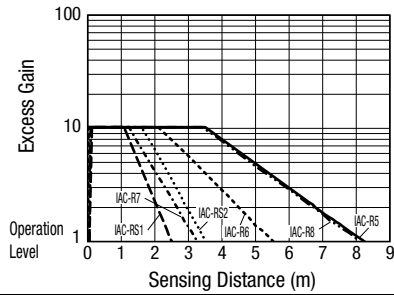

Operating Area

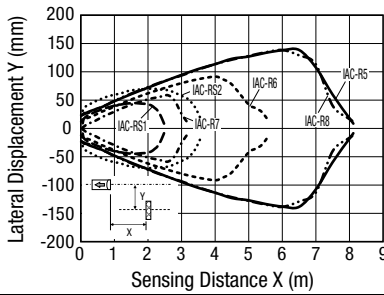

Angle

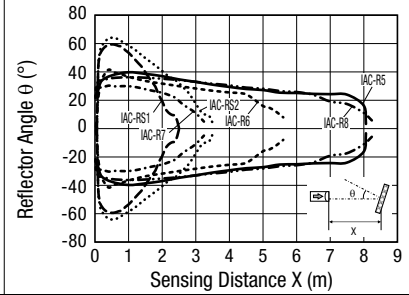

(3) Diffuse-reflective SA2E-DS□ (100mm)

Excess Gain vs. Sensing Distance

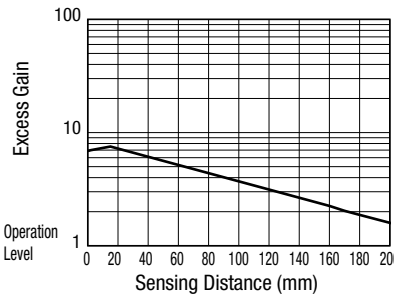

Operating Area

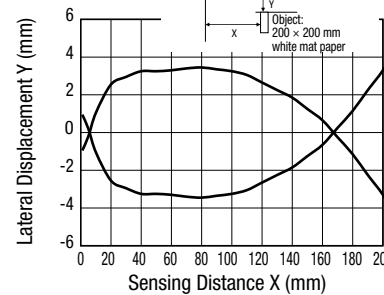

Sensing Distance vs. Object Size

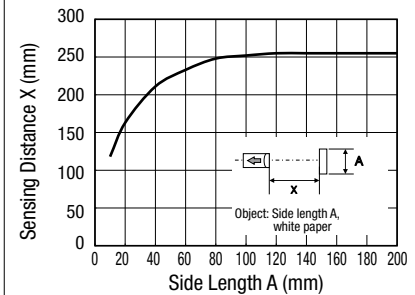

(4) Diffuse-reflective SA2E-DM□ (500mm)

Excess Gain vs. Sensing Distance

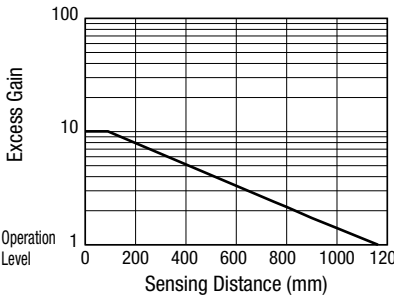

Operating Area

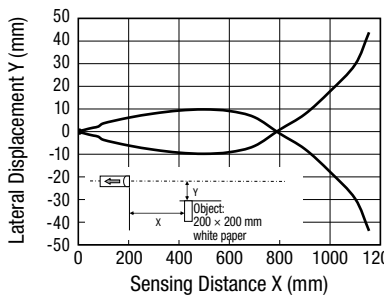

Sensing Distance vs. Object Size

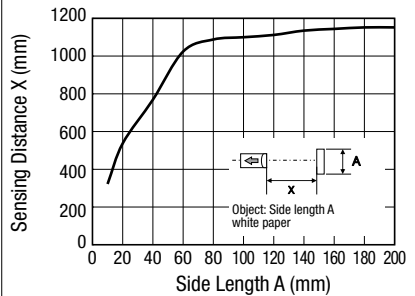

(5) Diffuse-reflective SA2E-DL□ (1m)

Excess Gain vs. Sensing Distance

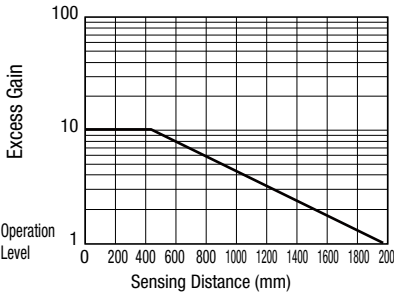

Operating Area

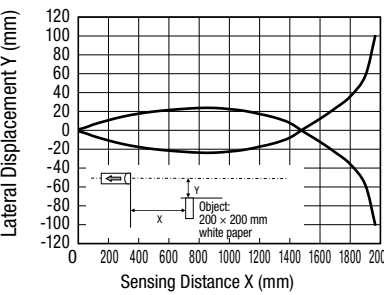

Sensing Distance

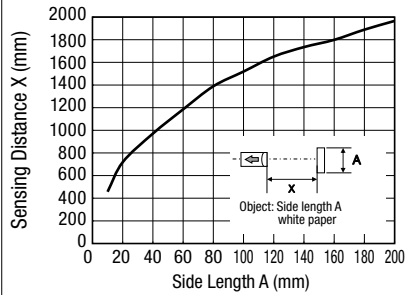

(6) Small-beam Reflective SA2E-N□

Excess Gain vs. Sensing Distance

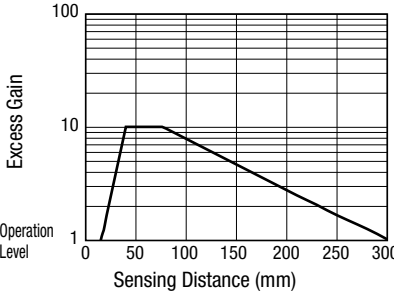

Operating Area

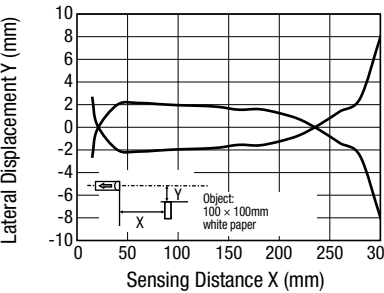

Sensing Area vs. Object Size

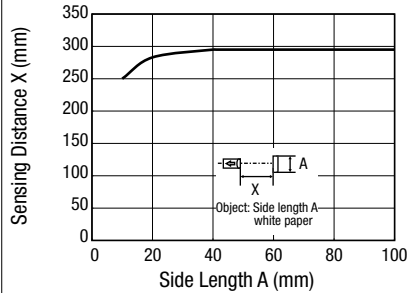

Characteristics (SA2E/SA1E)

(7) Background Suppression (BGS) SA2E-B□

Operating Area (Preset 100 mm)

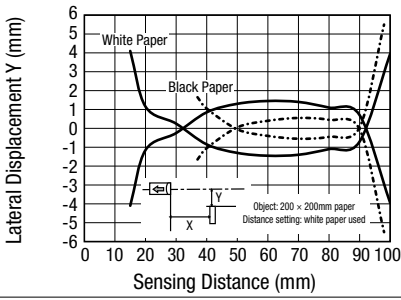

Operating Area (Preset 200 mm)

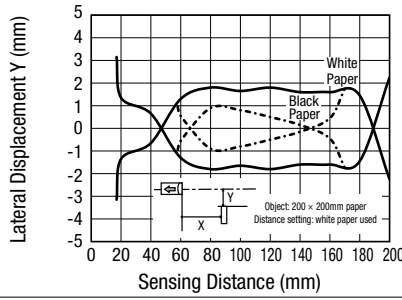

Operating Area (Preset 350 mm)

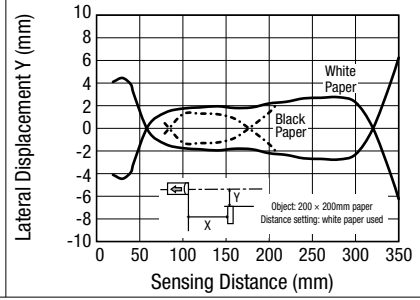

Light Beam Diameter vs. Sensing Distance

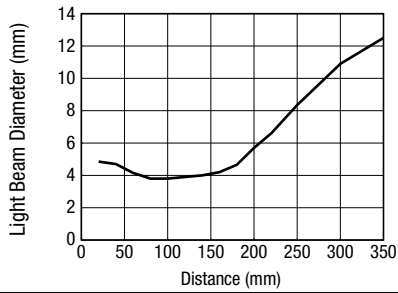

Hysteresis vs. Sensing Distance

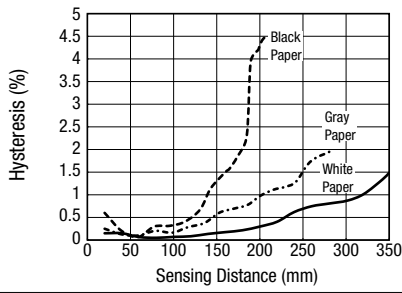

Sensing Distance vs. Control (turns)

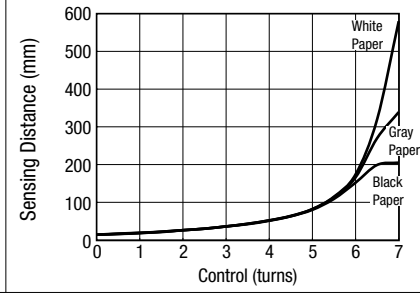

Color (200×200mm paper), material vs. Sensing Distance (Preset 100mm)

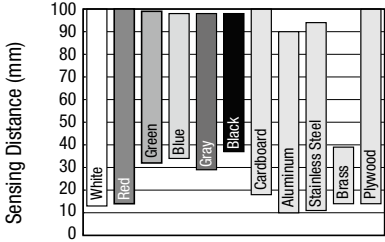

Color (200×200mm paper), material vs. Sensing Distance (Preset 200mm)

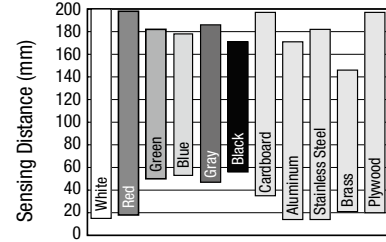

Color (200×200mm paper), material vs. Sensing Distance (Preset 350mm)

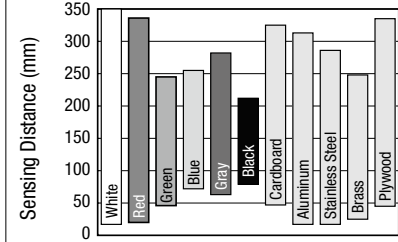

(8) Coaxial Polarized Retro-reflective (Transparent Object Sensing) (SA1E-X□)

Excess Gain vs. Sensing Distance

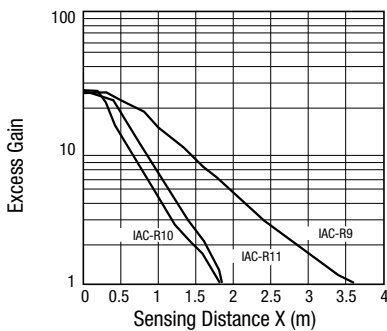

Operating Area

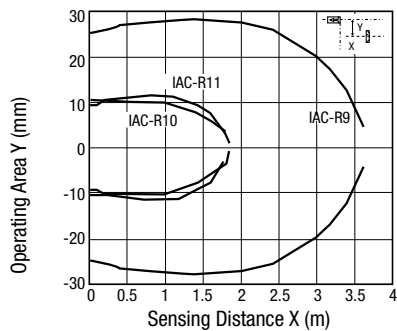

Angle

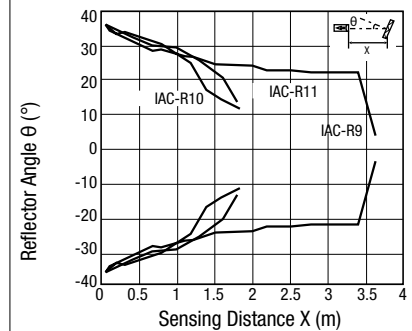

Light Beam Diameter vs. Distance

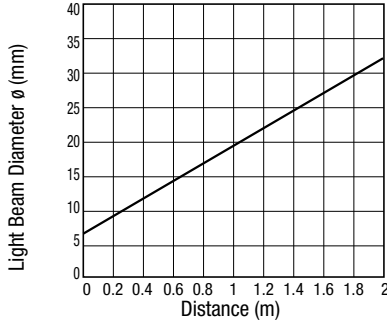

Characteristics (Typical) (SA1E-L)

(1) Through-beam SA1E-LT□

Excess Gain (Without slit)

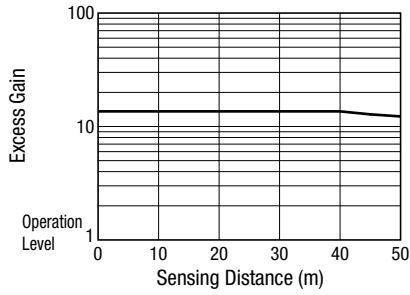

Excess Gain (With slit)

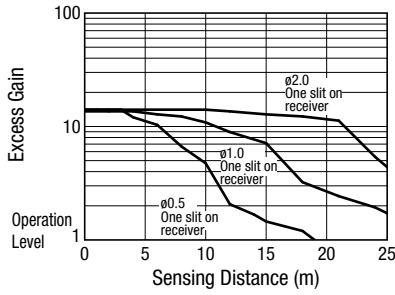

Lateral Displacement (Without slit)

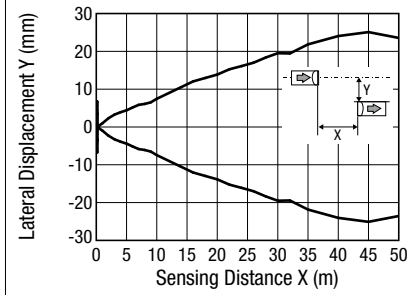

Angle (without slit)

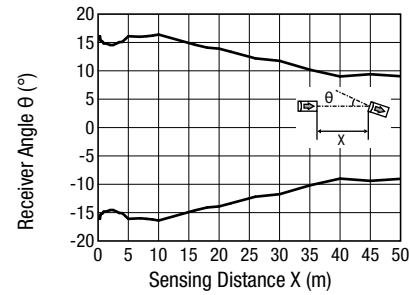

Light Beam Diameter

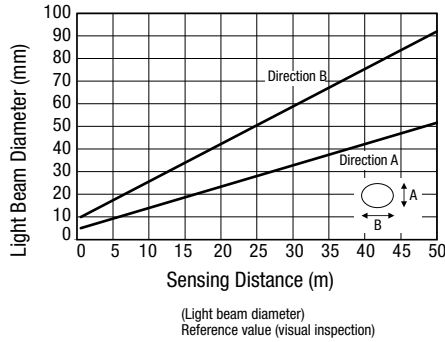

(2) Polarized Retro-reflective SA1E-LP□

Excess Gain

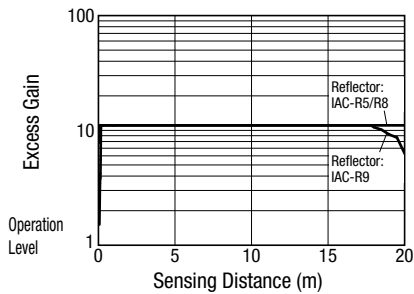

Lateral Displacement

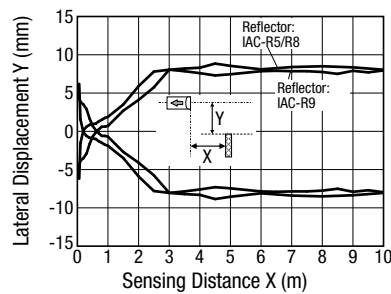

Angle

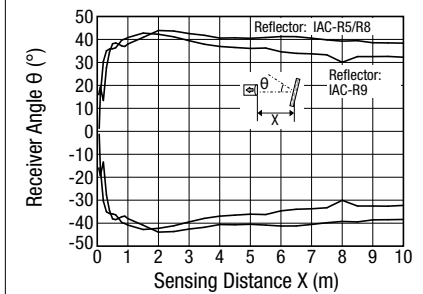

Light Beam Diameter

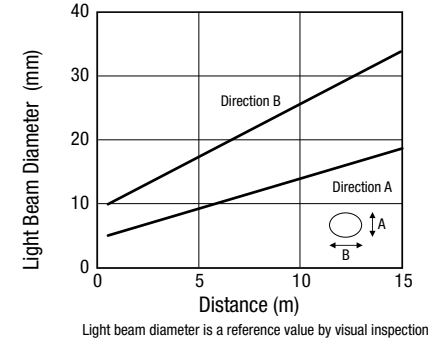

Characteristics (Typical) (SA1E-L)

(3) Background Suppression (BGS) SA1E-LB□

Operating Area (Preset 150mm)

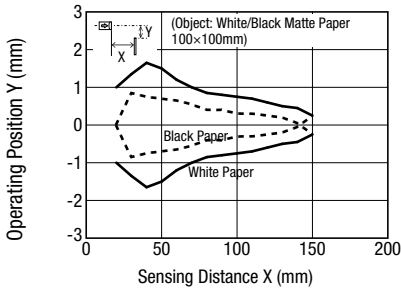

Operating Area (Preset 300mm)

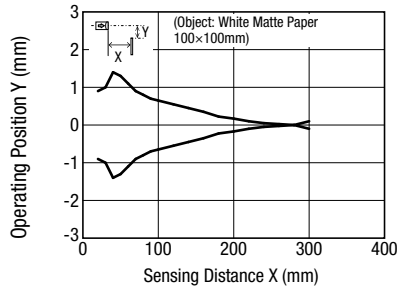

Light Beam Diameter

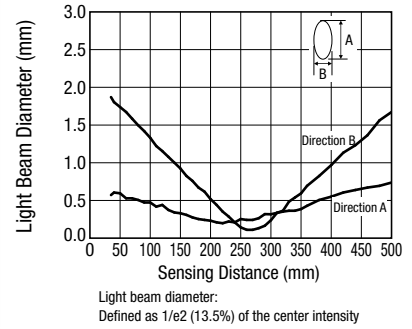

Color (100×100mm matte paper), material vs. Sensing Distance (Preset 150mm)

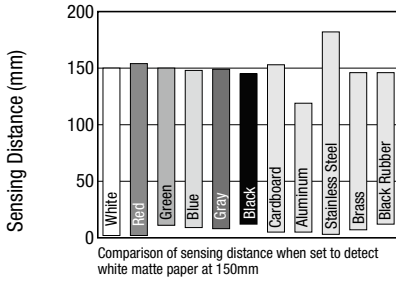

Color (100×100mm matte paper), material vs. Sensing Distance (Preset 300mm)

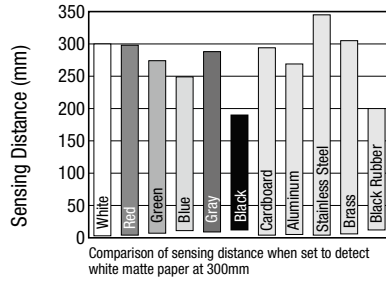

Sensing Distance vs. Control (turns)

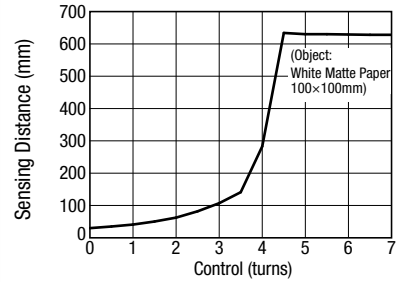

Accessories (SA2E/SA1E) (optional)
Slits (for through-beam)

When ordering, specify the Ordering No.

Item	Slit Size	Part No.	Ordering No.	Package Quantity
Vertical Slit	0.5mm × 18mm	SA9Z-S06	SA9Z-S06PN02	2
	1.0mm × 18mm	SA9Z-S07	SA9Z-S07PN02	
	2.0mm × 18mm	SA9Z-S08	SA9Z-S08PN02	
Horizontal Slit	0.5mm × 6.5mm	SA9Z-S09	SA9Z-S09PN02	
	1.0mm × 6.5mm	SA9Z-S10	SA9Z-S10PN02	
	2.0mm × 6.5mm	SA9Z-S11	SA9Z-S11PN02	
Round Slit	∅0.5mm	SA9Z-S12	SA9Z-S12PN02	
	∅1.0mm	SA9Z-S13	SA9Z-S13PN02	
	∅2.0mm	SA9Z-S14	SA9Z-S14PN02	

Reflectors (for polarized retro-reflective)

Package Quantity: 1

Item	Part No. (Ordering No.)	
Reflector	Standard	IAC-R5
	Small	IAC-R6
	Large	IAC-R8
	Narrow (rear/side mounting)	IAC-R7M
	Narrow (rear mounting)	IAC-R7B
	Narrow (side mounting)	IAC-R7S
	Tape Type (40 × 35mm)	IAC-RS1
	Tape Type (80 × 70mm)	IAC-RS2
Reflector Mounting Bracket	For IAC-R5	IAC-L2
	For IAC-R6	IAC-L3
	For IAC-R8	IAC-L5

* See P25 for dimensions.

- IAC-L2 is not supplied with mounting screws and nuts. Use commercially available M4 screws and nuts for mounting the IAC-R5 reflector.
- IAC-L3 is supplied with two mounting screws (M3 × 8mm sems screws).
- IAC-L5 is supplied with two mounting screws (M4 × 10mm sems screws).
- IAC-R7M and IAC-R7S are supplied with two M3 × 8mm self-tapping screws, two flat washers, and two spring washers. IAC-R7B is supplied with an M3 × 8mm self-tapping screw, a flat washer, and a spring washer.

Reflectors(used only for coaxial polarized retro-reflective)

Package Quantity: 1

Item	Part No. (Ordering No.)	
Reflector	Standard	IAC-R9
	Small	IAC-R10
	Ultra-small	IAC-R11
Reflector Mounting Bracket	For IAC-R9	IAC-L3

Mounting Brackets

Package Quantity: 1

Item	Part No. (Ordering No.)	
Main Unit Mounting Bracket	Vertical Mounting	SA9Z-K01
	Horizontal Mounting	SA9Z-K02
	Cover type	SA9Z-K03
	Back Mounting	SA9Z-K04

- Two mounting screws (M3 × 12mm sems screws) are supplied with the SA9Z-K01 and SA9Z-K02. Two mounting screws (M3 × 14mm sems screws) are supplied with the SA9Z-K03.
- The through-beam model requires two mounting brackets, one each for the projector and the receiver.
- SA9Z-K02 cannot be used for the connector types.
- Contact IDEC for mounting brackets for the connector.

Connector Cable (for M8 connector type)

Package Quantity: 1

Number of Core Wires	Style & Length	Part No. (Ordering No.)
4	Straight, 2m	SA9Z-CM8K-4S2
	Straight, 5m	SA9Z-CM8K-4S5
	Right angle, 2m	SA9Z-CM8K-4L2
	Right angle, 5m	SA9Z-CM8K-4L5

Air Blower Mounting Block

Package Quantity: 1

Item	Part No. (Ordering No.)
Air Blower Mounting Block	SA9Z-A02

- Two mounting screws (M3 × 20mm sems screws), one M5 × 6mm screw for plugging the air supply port, and one gasket (0.5mm thick) are supplied.
The air tube fitting and mounting bracket are not supplied and must be ordered separately. (Recommended mounting bracket: SA9Z-K01)
- Material: Anodized aluminum surface

Sensitivity Control Screwdriver

Package Quantity: 1

Item	Part No. (Ordering No.)
Sensitivity Control Screwdriver 	SA9Z-AD01

Accessory Dimensions (SA2E/SA1E) (optional)

All dimensions in mm

Mounting Brackets

SA9Z-K01

(Material: Stainless)

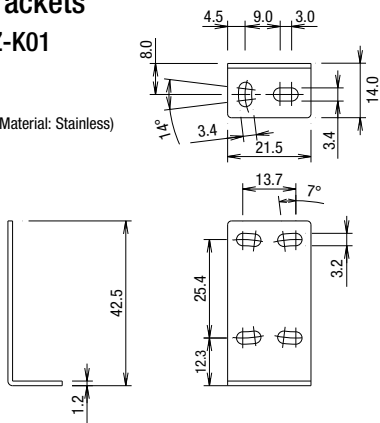

With Mounting Bracket

*1: Center of optical axis (through-beam)
*2: Center of optical axis (polarized retro-reflective, diffuse-reflective, spot-beam reflective models)

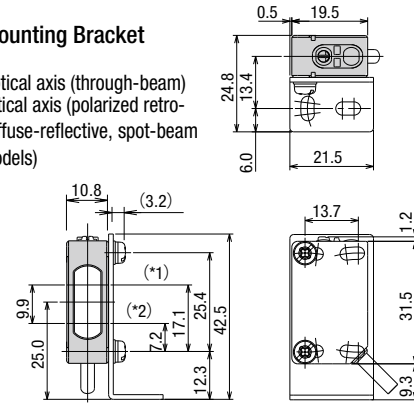

SA9Z-K02

(Material: Stainless)

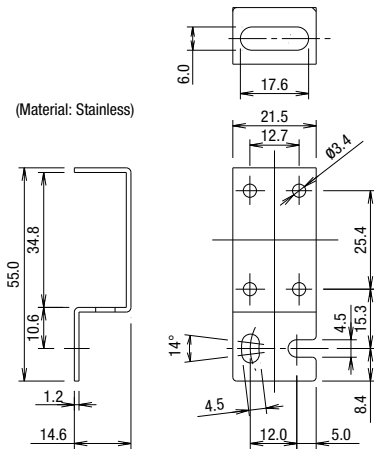

With Mounting Bracket

*1: Center of optical axis (through-beam)
*2: Center of optical axis (polarized retro-reflective, diffuse-reflective, spot-beam reflective models)

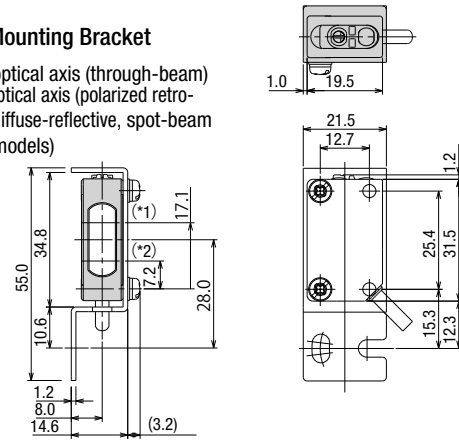

SA9Z-K03

(Material: Stainless)

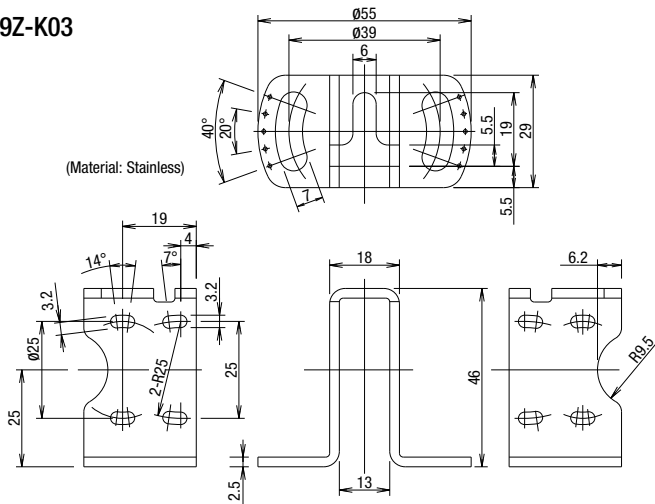

With Mounting Bracket

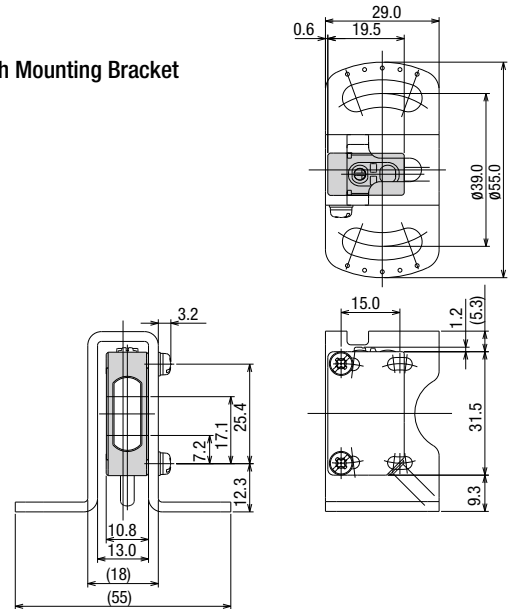

SA9Z-K04

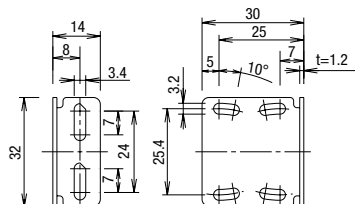

With Mounting Bracket

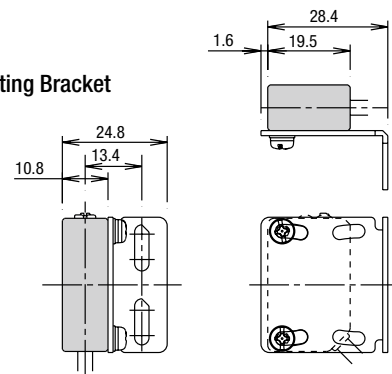

Accessory Dimensions (SA2E/SA1E) (optional)

All dimensions in mm

Reflectors

IAC-R5

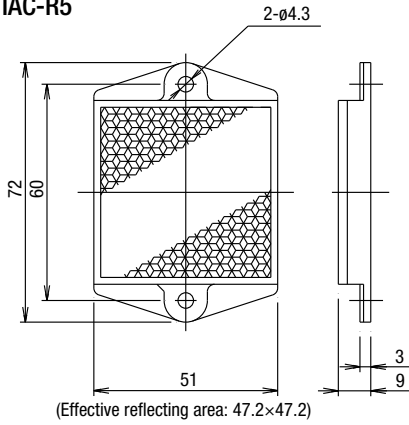

IAC-R6

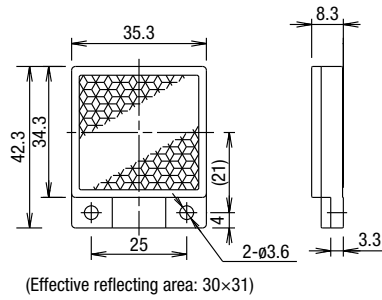

IAC-R8

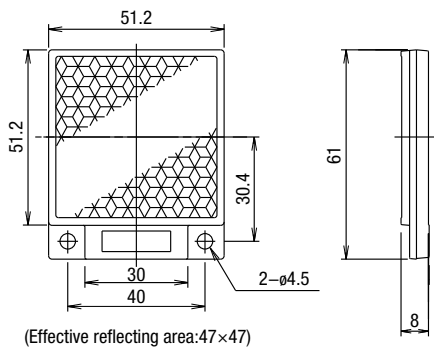

IAC-RS1

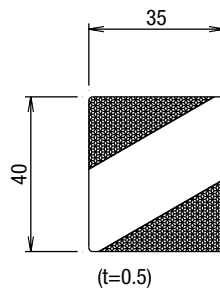

IAC-RS2

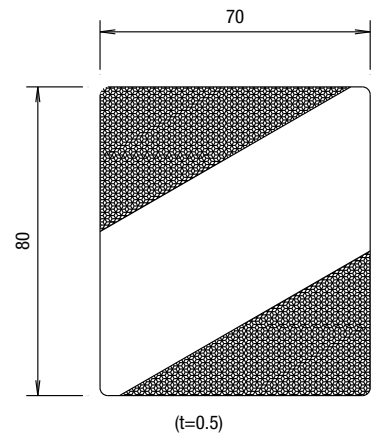

IAC-R7M (rear/side mounting)

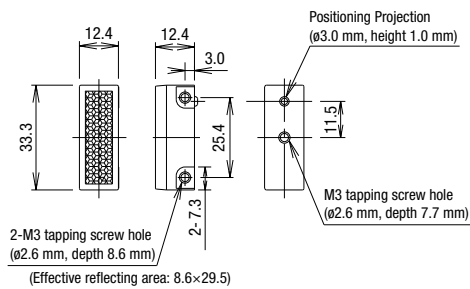

IAC-R7B (rear mounting)

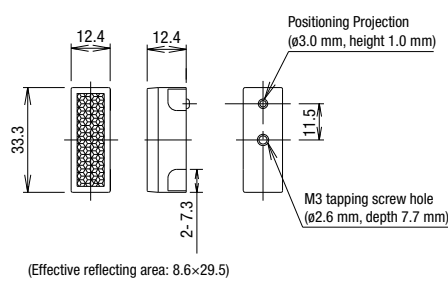

IAC-R7S (side mounting)

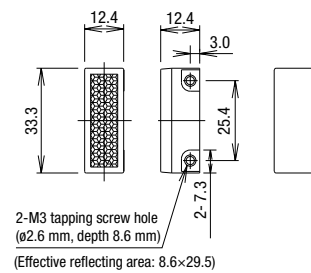

Note: The mounting plate for reflector must be 0.8 to 2.5mm in thickness.

Note: The mounting plate for reflector must be 0.8 to 2.5mm in thickness.

Note: The mounting plate for reflector must be 0.8 to 2.5mm in thickness.

IAC-R9

Reflector for SA1E-X (Coaxial Polarized Retro-reflective)

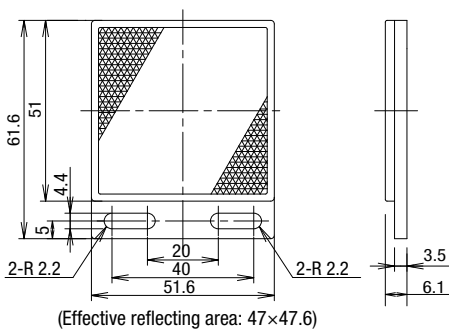

IAC-R10

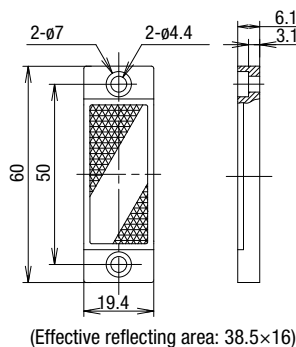

IAC-R11

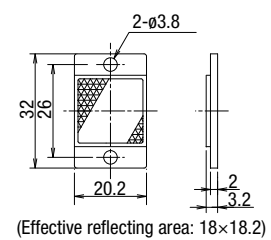

Accessory Dimensions (SA2E/SA1E) (optional)

All dimensions in mm.

Reflector Mounting Brackets

IAC-L2 (for IAC-R5)

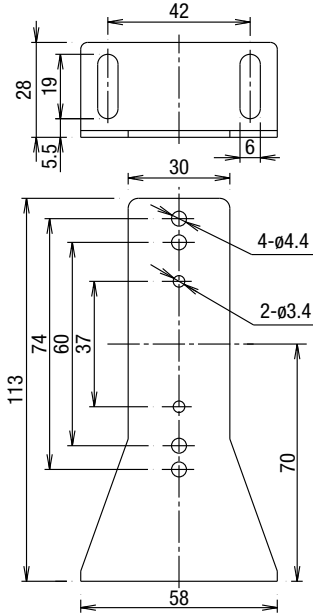

Material: SPCC

IAC-L3 (for IAC-R6)

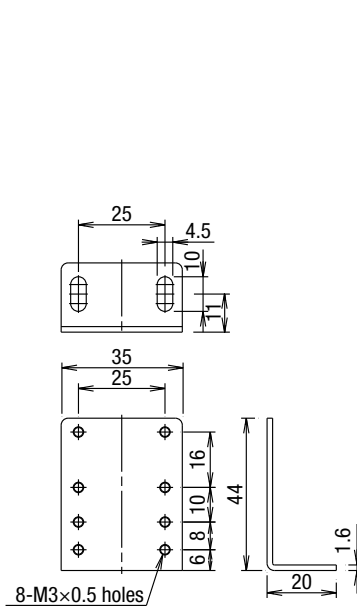

Material: SPCC

IAC-L5 (for IAC-R8)

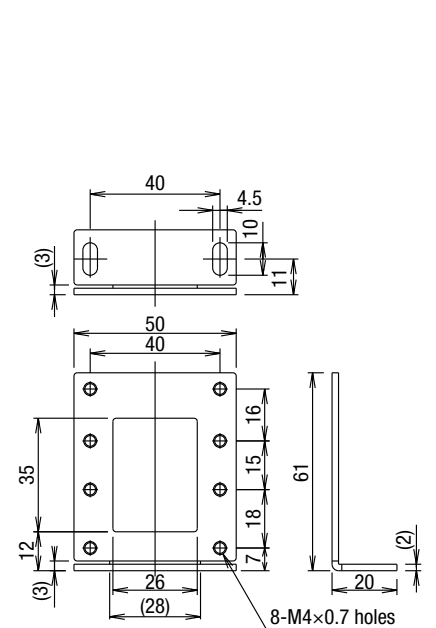

Material: SPCC

Connector Cable (connector on one end)

Straight
SA9Z-CM8K-4S□

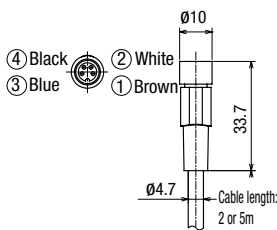

Right-angle
SA9Z-CM8K-4L□

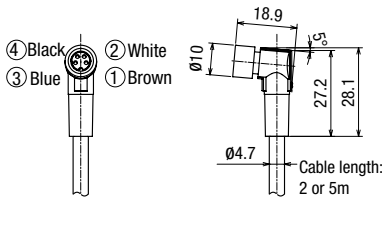

Slit Dimensions

Vertical Slit
SA9Z-S06
SA9Z-S07
SA9Z-S08

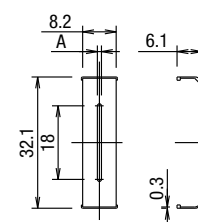

Material: Stainless Steel

Horizontal Slit
SA9Z-S09
SA9Z-S10
SA9Z-S11

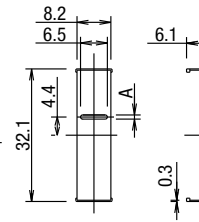

Material: Stainless Steel

Round Slit
SA9Z-S12
SA9Z-S13
SA9Z-S14

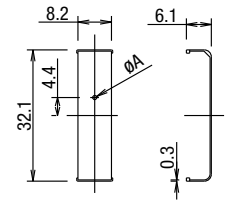

Material: Stainless Steel

Note: Dielectric strength when installed on the unit: 1000V AC (between live part and mounting bracket, except between live part and tightening ring)

Note: For slit width A, see P13.

Air Blower Mounting Block

SA9Z-A02

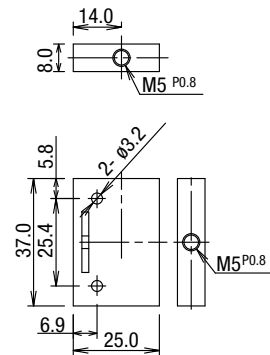

Air Blower Mounting Block

With Mounting Bracket

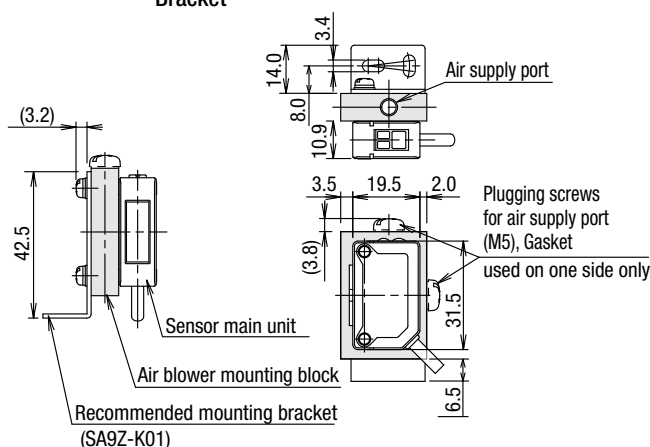

• The SA9Z-A02 air blower mounting block is supplied with two mounting screws (M3 × 20mm semi screws), one screw for plugging the air supply port (M5 × 6 mm), and one gasket for plugging the air supply port (1mm thick).

• An air tube fitting (M5) can be installed to either the top or side. Tighten the fitting to a torque of 0.5 N·m maximum.

• The air tube fitting and mounting bracket are not supplied and must be ordered separately. (Recommended mounting bracket: SA9Z-K01)

Material: Anodized aluminum surface

⚠ Safety Precautions

- Be sure to turn off the power before performing installation, removal, wiring, maintenance, or inspection work. Failure to do so could result in electric shock and fire.

Operating Instructions

Indicator and Output Operation

The operation LED turns on (yellow) when the control output is on.

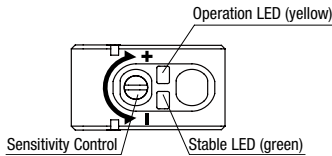

- The stable LED turns on (green) either at stable incident or stable interruption. Make sure to use the photoelectric switch after the stable operation is ensured.
- In the light ON operation, the output turns on when the receiving light intensity level is 1.0 or over as shown on the right.
- In the dark ON operation, the output turns on when the receiving light intensity level is less than 1.0 as shown on the right.

Receiving Light Intensity Level	Light Receiving Status	Stable LED (green)	Operation LED (yellow)/ Control Output	
			Light ON	Dark ON
Operation Level	1.05 and over	Stable Incident	ON	OFF
	1.0 and over Less than 1.0	Unstable Incident	OFF	ON
		Unstable Interruption		
0.6 and below	Stable Interruption	ON	OFF	ON

Optical Axis Alignment (Light ON)

Through-beam

Fasten the receiver temporarily. Place the projector to face the receiver. Move the projector up, down, right and left to find the range where the operation LED turns on. Fasten the projector in the middle of the range. Next, move the receiver up, down, right and left in the same manner and fasten in the middle of the range where the operation LED turns on. Make sure that stable LED turns on at stable incident and stable interruption.

Polarized retro-reflective

Install the reflector perpendicularly to the optical axis. Move the SA1E photoelectric switch up, down, right and left to find the range where the operation LED turns on. Fasten the switch in the middle of the range. Polarized retro-reflective model can be installed also by finding the position where the reflection of projected red light is most intense, while observing the reflection on the reflector from behind the switch. Make sure that stable LED turns on at stable incident and stable interruption.

Diffuse-reflective/Small-beam reflective

Place the SA1E photoelectric switch where the switch can detect the object. Move the switch up, down, right and left to find the range where the operation LED turns on. Fasten the switch in the middle of the range. Make sure that stable LED turns on at stable incident and stable interruption. Because the light source element of diffuse-reflective model (Medium Distance) and small-beam reflective model is a red LED, visual inspection is possible as well.

Sensitivity Adjustment

Referring to the table at right, adjust the sensitivity of the SA1E photoelectric switch when necessary, in such cases as the through-beam model is used to detect small or translucent objects or the reflective model is affected by background. The table explains the status of operation LED when the operation mode is set to light ON.

- After adjusting the sensitivity, make sure that stable LED turns on at stable incident and stable interruption. For detecting objects too small to turn on the stable LED, use an optional slit.
- Sensitivity is set to the maximum (+) at the factory before shipment. When adjusting the sensitivity, use the screwdriver supplied with the SA1E photoelectric switch to turn the control as shown below, to a torque of 0.05 N·m maximum.

Step	Photoelectric Switch Status	Sensitivity Control	Adjusting Procedure
1	Receiving light <ul style="list-style-type: none"> • Through-beam, polarized reflective: No object detected • Diffuse reflective, small-beam reflective: Object detected 		Turn the control counter-clockwise to the minimum (-). Then turn clockwise (toward +) until the operation LED turns on (turns off with dark ON type) (point A).
2	Light is interrupted <ul style="list-style-type: none"> • Through-beam, polarized reflective: Object detected • Diffuse reflective, small-beam reflective: No object detected 		At interruption status, turn the control clockwise (toward +) from point A, until the operation LED turns on (turns off with dark ON type) (point B). If the operation LED does not turn on (turn off with dark ON type) even though the control has reached the maximum (+), set the maximum position (+) as point B.
3	—		Set the middle point between point A and B as point C.

Adjustment of Sensing Range for Background Suppression (BGS) Model

- When adjusting the sensing range, follow the instruction below.

Step	Distance Control	Adjusting Procedure
1		Install the photoelectric switch and the object firmly. Turn the control counterclockwise until the operation LED turns off (turns on with dark ON type). From this point, turn the control clockwise until the operation LED turns on (turns off with dark ON type) (point A).
2		Remove the object, and confirm that the operation LED turns off (turns on with dark ON type). Turn the control clockwise until the operation LED turns on (detecting the background) (turns off with dark ON type) (point B). (Note 1)
3		Set the middle point between point A and B as point C. (Note 2)

Note 1: When the background is far off and not detected, turn the control 360°, and set the point as point C.

Note 2: Because the control is multi-turn, it may take more than one turn to move from point A to point B.

Note 3: Turning the control clockwise lengthens the sensing distance.

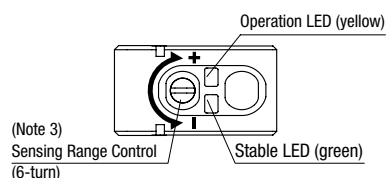

Operating Instructions

Power Supply and Wiring

- Do not use the SA1E photoelectric switch at the transient status immediately after turning on the power (approx. 100 ms). When the load and switch use different power supplies, make sure to power up the switch first.
- Use a power supply with little noise and inrush current, and use the photoelectric switch within the rated voltage range. Make sure that ripple factor is within the allowable limit. Do not apply AC voltage, otherwise the switch may blow out or burn.
- When using a switching power supply, make sure to ground the FG (frame ground) terminal, otherwise high-frequency noise may affect the photoelectric switch.
- Turn power off before inserting/removing the cable wiring or connector on the connector model photoelectric switch. Make sure that excessive mechanical force is not applied to the connector. Connect the connector cable to a tightening torque of 0.5 N·m maximum.
- To ensure the degree of protection, use the applicable connector cable for the connector model. Connector cables are ordered separately.
- Avoid parallel wiring with high-voltage or power lines in the same conduit, otherwise noise may cause malfunction and damage. When wiring is long, use a separate conduit for wiring.
- Use a cable of 0.3 mm² minimum core wires, then the cable can be extended up to 100m.

Installation

Installing the Photoelectric Switch

- Do not install the SA1E photoelectric switches in an area where the switches are subject to the following conditions, otherwise malfunction and damage may be caused.
 - * Inductive devices or heat source
 - * Extreme vibration or shock
 - * Large amount of dust
 - * Water, oil, chemicals
 - * Outdoor
- Make sure to prevent sunlight, fluorescent light, and especially the fluorescent light of inverters from entering the receiver of the photoelectric switch directly.
- Interference prevention allows two SA1E switches to be mounted in close proximity. However, the through-beam model is not equipped with interference prevention. Maintain appropriate distance between the switches referring to the lateral displacement characteristics.
- Because the SA1E photoelectric switches are IP67 waterproof, the SA1E can be exposed to water. However, wipe water drops and smears from the lens and slit using a soft cloth to make sure of the best detecting performance.
- Polycarbonate or acrylic resin is used for optical elements and will dissolve in organic solvents such as ammonia, sodium hydroxide, alcohol, and benzene. To remove dust and moisture build-up, use a soft dry cloth.
- Tighten the mounting screws (M3) to a torque of 0.5N·m. Do not tighten the mounting screws excessively or hit the switch with a hammer, otherwise the protection degree cannot be maintained and may cause damage.

Installing the Reflector

- Use M4 mounting screws for the IAC-R5 and IAC-R8 reflector, and M3 mounting screws for the IAC-R6 reflector. Tighten the mounting screws to a tightening torque of 0.5 N·m maximum. Mounting screws are not supplied with the switch.
- Use the M3 self-tapping screw, flat washer, and spring washer to tighten the IAC-R7 reflector to a torque of 0.5 to 0.6 N·m.
- Optional reflector mounting bracket IAC-L2 is not supplied with mounting screws or nuts.
- IAC-L3 and IAC-L5 are supplied with mounting screws for mounting the reflector on the bracket.
- Reflector IAC-RS1 and IAC-RS2 can be installed directly on a flat surface using the adhesive tape attached to the back of the reflector. Before attaching the reflector, clean the board surface to ensure secure attachment.

Installing the air blower mounting block SA9Z-A02

- When installing the SA9Z-A02 on the SA1E photoelectric switch, use the attached M3 × 20 mounting screws and tighten to a torque of 0.5 N·m maximum.
- Do not use the mounting screw (M3 × 12) supplied with the mounting bracket (SA9Z-K01) to mount the SA1E photoelectric switches.
- The SA9Z-A02 cannot be used with the through-beam slits (SA9Z-S06 to S14).
- The air tube fitting (M5) can be installed to either the top or side. The air tube is not supplied.
- Close the unused port using the air supply port plugging screw and gasket (supplied with SA1E) to a tightening torque of 1 to 2 N·m maximum. The recommended air pressure is 0.1 to 0.3 MPa.

Installing the background suppression (BGS) model

- This sensor can detect objects correctly when the sensor head is installed perpendicular to the moving object. Install the sensor head as shown below to minimize sensing errors.

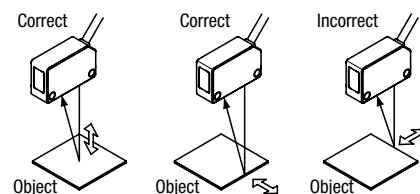

- If the sensor is used in a place subject to a large variations in the ambient temperature, the characteristics may change depending on the target object. Be sure to check the operation under the actual operating conditions.

Operating Instructions

Read the instruction manual carefully before performing installation, wiring, maintenance, and inspection work, and before operating this product. Be sure to use the product correctly.

For details about mounting methods, wiring, and maintenance, see the instruction manuals at the following URLs.

URL SA2E ----- <https://product.idec.com/?product=SA2E>
 SA1E-X ----- <https://product.idec.com/?product=SA1E-X>
 SA1E-L ----- <https://product.idec.com/?product=SA1E-L>



SA2E



SA1E-X



SA1E-L

Product Information

USB Powered Portable Sensor Checker

SA1P



Easily connects 24V DC devices at any location. An external USB battery can be used enabling easy device testing and continuity check for 24V DC devices without power outlets near by. Connects to PCs using a USB connector.

Photoelectric Sensors

SA1U



Universal voltage types operate on 24-240V AC and 12-240V DC. DC power types operate on 12-24V DC. Four sensing methods (through-beam, polarized retro-reflective, diffuse-reflective, and background suppression).

Magnetic Proximity Sensors

DPRI



The DPRI magnetic proximity switch incorporates a sealed reed switch and four magnets inside a compact housing. This self-contained proximity switch requires no external power supply and can detect the presence of magnetic objects without contact.



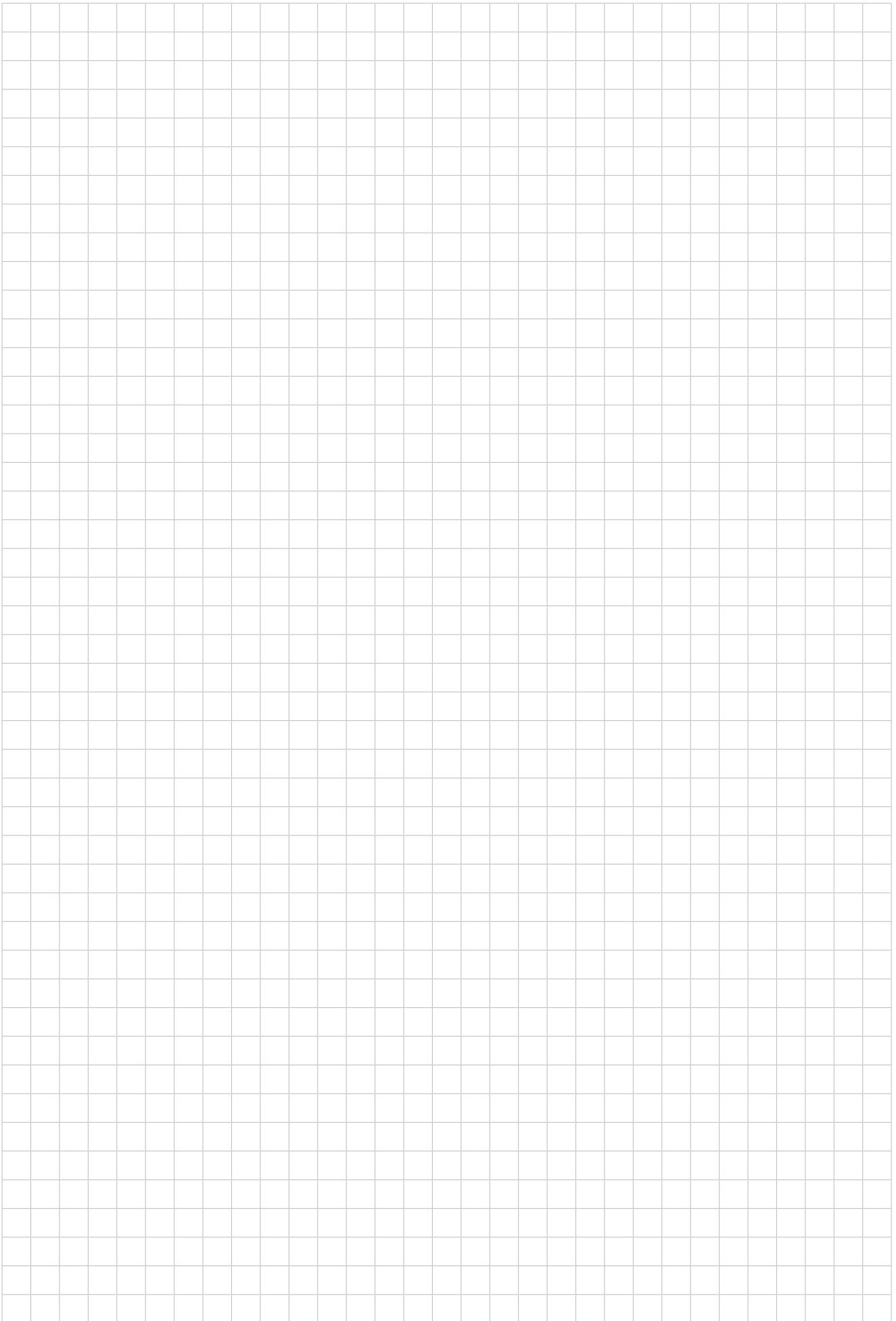

Ordering Terms and Conditions

Thank you for using IDEC Products.

By purchasing products listed in our catalogs, datasheets, and the like (hereinafter referred to as "Catalogs") you agree to be bound by these terms and conditions. Please read and agree to the terms and conditions before placing your order.

1. Notes on contents of Catalogs

- (1) Rated values, performance values, and specification values of IDEC products listed in this Catalog are values acquired under respective conditions in independent testing, and do not guarantee values gained in combined conditions.
Also, durability varies depending on the usage environment and usage conditions.
- (2) Reference data and reference values listed in Catalogs are for reference purposes only, and do not guarantee that the product will always operate appropriately in that range.
- (3) The specifications / appearance and accessories of IDEC products listed in Catalogs are subject to change or termination of sales without notice, for improvement or other reasons.
- (4) The content of Catalogs is subject to change without notice.

2. Note on applications

- (1) If using IDEC products in combination with other products, confirm the applicable laws / regulations and standards.
Also, confirm that IDEC products are compatible with your systems, machines, devices, and the like by using under the actual conditions. IDEC shall bear no liability whatsoever regarding the compatibility with IDEC products.
- (2) The usage examples and application examples listed in Catalogs are for reference purposes only. Therefore, when introducing a product, confirm the performance and safety of the instruments, devices, and the like before use. Furthermore, regarding these examples, IDEC does not grant license to use IDEC products to you, and IDEC offers no warranties regarding the ownership of intellectual property rights or non-infringement upon the intellectual property rights of third parties.
- (3) When using IDEC products, be cautious when implementing the following.
 - i. Use of IDEC products with sufficient allowance for rating and performance
 - ii. Safety design, including redundant design and malfunction prevention design that prevents other danger and damage even in the event that an IDEC product fails
 - iii. Wiring and installation that ensures the IDEC product used in your system, machine, device, or the like can perform and function according to its specifications
- (4) Continuing to use an IDEC product even after the performance has deteriorated can result in abnormal heat, smoke, fires, and the like due to insulation deterioration or the like. Perform periodic maintenance for IDEC products and the systems, machines, devices, and the like in which they are used.
- (5) IDEC products are developed and manufactured as general-purpose products for general industrial products. They are not intended for use in the following applications, and in the event that you use an IDEC product for these applications, unless otherwise agreed upon between you and IDEC, IDEC shall provide no guarantees whatsoever regarding IDEC products.
 - i. Use in applications that require a high degree of safety, including nuclear power control equipment, transportation equipment (railroads / airplanes / ships / vehicles / vehicle instruments, etc.), equipment for use in outer space, elevating equipment, medical instruments, safety devices, or any other equipment, instruments, or the like that could endanger life or human health
 - ii. Use in applications that require a high degree of reliability, such as provision systems for gas / waterworks / electricity, etc., systems that operate continuously for 24 hours, and settlement systems
 - iii. Use in applications where the product may be handled or used deviating from the specifications or conditions / environment listed in the Catalogs, such as equipment used outdoors or applications in environments subject to chemical pollution or electromagnetic interference
If you would like to use IDEC products in the above applications, be sure to consult with an IDEC sales representative.

3. Inspections

We ask that you implement inspections for IDEC products you purchase without delay, as well as thoroughly keep in mind management/maintenance regarding handling of the product before and during the inspection.

4. Warranty

(1) Warranty period

The warranty period for IDEC products shall be one (1) year after purchase or delivery to the specified location. However, this shall not apply in cases where there is a different specification in the Catalogs or there is another agreement in place between you and IDEC.

(2) Warranty scope

Should a failure occur in an IDEC product during the above warranty period for reasons attributable to IDEC, then IDEC shall replace or repair that product, free of charge, at the purchase location / delivery location of the product, or an IDEC service base. However, failures caused by the following reasons shall be deemed outside the scope of this warranty.

- i. The product was handled or used deviating from the conditions / environment listed in the Catalogs
- ii. The failure was caused by reasons other than an IDEC product
- iii. Modification or repair was performed by a party other than IDEC
- iv. The failure was caused by a software program of a party other than IDEC
- v. The product was used outside of its original purpose
- vi. Replacement of maintenance parts, installation of accessories, or the like was not performed properly in accordance with the user's manual and Catalogs
- vii. The failure could not have been predicted with the scientific and technical standards at the time when the product was shipped from IDEC
- viii. The failure was due to other causes not attributable to IDEC (including cases of force majeure such as natural disasters and other disasters)

Furthermore, the warranty described here refers to a warranty on the IDEC product as a unit, and damages induced by the failure of an IDEC product are excluded from this warranty.

5. Limitation of liability

The warranty listed in this Agreement is the full and complete warranty for IDEC products, and IDEC shall bear no liability whatsoever regarding special damages, indirect damages, incidental damages, or passive damages that occurred due to an IDEC product.

6. Service scope

The prices of IDEC products do not include the cost of services, such as dispatching technicians. Therefore, separate fees are required in the following cases.

- (1) Instructions for installation / adjustment and accompaniment at test operation (including creating application software and testing operation, etc.)
- (2) Maintenance inspections, adjustments, and repairs
- (3) Technical instructions and technical training
- (4) Product tests or inspections specified by you

The above content assumes transactions and usage within your region. Please consult with an IDEC sales representative regarding transactions and usage outside of your region. Also, IDEC provides no guarantees whatsoever regarding IDEC products sold outside your region.

IDEC CORPORATION

Head Office 6-64, Nishi-Miyahara-2-Chome, Yodogawa-ku, Osaka 532-0004, Japan

USA IDEC Corporation
EMEA APEM SAS

Singapore IDEC Izumi Asia Pte. Ltd.
Thailand IDEC Asia (Thailand) Co., Ltd.
India IDEC Controls India Private Ltd.

China IDEC (Shanghai) Corporation
IDEC Izumi (H.K.) Co., Ltd.
Taiwan IDEC Taiwan Corporation

Japan IDEC Corporation

 www.idec.com

Specifications and other descriptions in this brochure are subject to change without notice.
Information in this brochure is current as of July, 2023.
2023 IDEC Corporation, All Rights Reserved.

EP1750-5

