

LED SignalLight Towers

LD6A



Ergonomically designed for visual and audible recognition



• See website for details on approvals and standards.

Steady / Flashing / Alarm models available

Flashing cycle complies with IEC standards

[1.75 Hz (approx. 105 times per second)]



IEC 60073 Sixth edition 2002 Chapter 4.2.3
"Coding by changing of characteristics over time"

Unique powerful design with 360-degree sound field.
Two alarm sound patterns available.

Alarm sound at 3.3 kHz and maximum sound level of 90 dB. With IDEC's unique resonant design, the SignalLight has a frequency that is most sensitive to the human ear and sends a clear sound over 360 degrees. Therefore, the sound recognition is improved as the alarm can be heard in a noisy environment, enhancing safety.

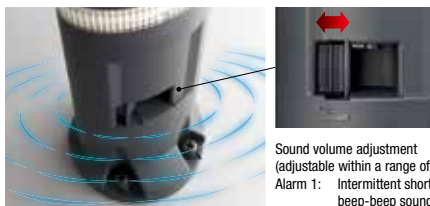

Sound volume adjustment
(adjustable within a range of 70 to 90 dB)

Alarm 1: Intermittent short
beep-beep sound
Alarm 2: Intermittent long
beep-beep sound

Stylish design with high functionality

Unique design — oval shape with striped design for clear visibility

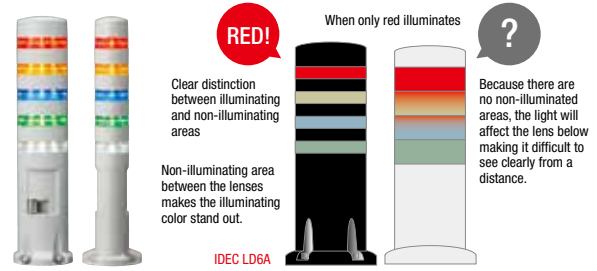

Easy installation and assembly

Different mounting styles

L-shaped bracket available for pole mounting. Can also be mounted directly to equipment.

Five mounting styles available.

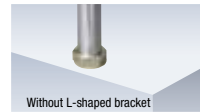
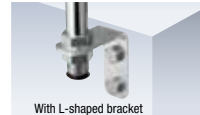

Easy Assembly

The unique secure terminal style of the LED module makes assembly quick and easy, enabling assembly using only one hand.



Plug-in Terminals

Highly reliable plug-in terminals. Easy expansion of LED module.



Unique lens shape offers high visibility

Three different illumination methods and a unique lens shape enable high visibility from all directions.

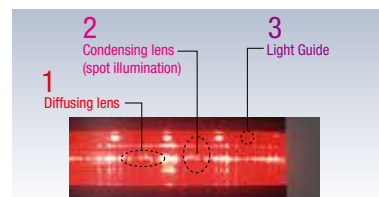
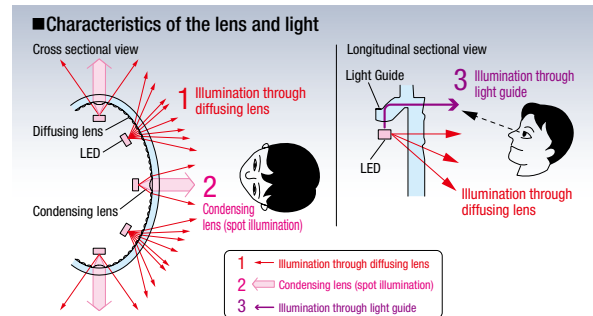

By combining a diffusing lens, which diffuses the light broadly, with a condensing lens, a super bright area is created enabling high visibility. Also, the illumination through the light guide enhances the visibility when the SignalLight is viewed from below.



LD6A LED Signalight Towers

Oval shape with striped design. Presents a stylish image on all equipment.



General Specifications

Safety Standards	IEC 60947-5-1, EN60947-5-1, UL508, CSA C22.2 No.14
Operating Temperature	-25 to +55°C (no freezing)
Operating Humidity	45 to 85% RH (no condensation)
Storage Temperature	-40 to +75°C (no freezing)
Overvoltage Category	III (IEC 60664-1)
Impulse Withstand Voltage	800V (IEC 60947-1)
Insulation Resistance	100 MΩ minimum (500V DC megger)
Dielectric Strength	Between live and dead parts: 1000V AC, 1 minute
Pollution Degree	3
Corrosion Immunity	Atmosphere free from corrosive gases
Vibration Resistance	Operating extremes: 10 to 55 Hz, amplitude 0.5 mm
Shock Resistance	Operating extremes: 147 m/s ² , 6 shocks each in 6 axes
Degree of Protection (IEC 60529)	Steady: IP65 Steady/flashing/alarm: IP54 Pole mount (w/o L-shaped bracket): IP54 Pole mount (w/L-shaped bracket): IP23
Housing Color	Dark gray, Light gray
Material	Housing: ABS resin Lens: AS resin Pole: Steel (nickel-chrome plated) Pole stand: Diecast aluminum
Cable	UL1007 AWG22

Part No. Development

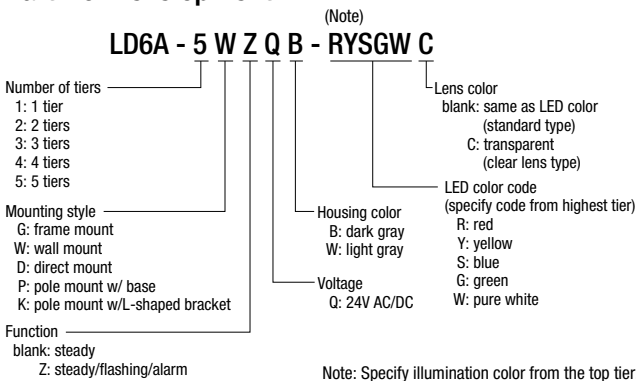

Functional Specifications

Rated Insulation Voltage	60V			
Operating Voltage	24V AC/DC ±10%			
Rated Voltage (Ue)	24V AC/DC			
LED Color Code	R (red), Y (yellow), S (blue), G (green), W (pure white)			
LED	Illumination Color	R, Y	S, G	W
	Rated Current (per tier)	25 mA	30 mA	20 mA
	Power Consumption (per tier)	0.6W	0.75W	0.5W
LED Life (Note)	Approx. 30,000 hours (until the brightness reduces to 50% the initial value when lit at complete direct current of the rated voltage under 25°C environment)			
Flashing Cycle (IEC 60073)	Approx. 105 flashes per minute (1.75 Hz)			
Alarm	Alarm Cycle	Alarm 1: approx. 700 times per minute Alarm 2: approx. 35 times per minute		
	Draw Current	110 mA max.		
	Inrush Current	AC: 400 mA max. DC: 250 mA max.		
	Alarm Volume	70 to 90 dB, at 1m (volume adjustable)		
	Acoustic Frequency	Approx. 3.3 kHz		

Note: Life of the LED varies according to operating conditions and environment.

External Contact Ratings

LED	AC Contact Capacity (per tier)	Current Capacity	100 mA min.
		Dielectric Strength	35V AC min.
	DC Contact Capacity, Transistor Capacity (per tier)	Current Capacity	100 mA min.
		Dielectric Strength	35V min.
		Leakage Current	0.1 mA max.
Alarm	AC Contact Capacity (per alarm)	Current Capacity	400 mA min.
		Dielectric Strength	35V AC min.
	DC Contact Capacity, Transistor Capacity (per alarm)	Current Capacity	300 mA min.
		Dielectric Strength	35V min.
		Leakage Current	0.1 mA max.

APEM

Switches & Pilot Lights

Control Boxes

Emergency Stop Switches

Enabling Switches

Safety Products

Explosion Proof

Terminal Blocks

Relays & Sockets

Circuit Protectors

Power Supplies

LED Illumination

Controllers

Operator Interfaces

Sensors

AUTO-ID

Flush Silhouette

ø16

ø22

ø30

Miniature

Pilot Lights

HW1Z

AP22

A Series

LD6A



Download catalogs and CAD from <http://asia.idec.com/downloads>

Assembled Products

Package Quantity: 1

Mounting Style	Tiers	LED Color Code	Steady		Steady/Flashing/Alarm	
			Part No.	Weight (approx.)	Part No.	Weight (approx.)
Frame Mount	1	R, Y, S, G, W	LD6A-1GQ*-□	220g	LD6A-1GZQ*-□	310g
	2	RY, RG	LD6A-2GQ*-□	260g	LD6A-2GZQ*-□	350g
	3	RYS, RYG	LD6A-3GQ*-□	300g	LD6A-3GZQ*-□	390g
	4	RYSG	LD6A-4GQ*-□	340g	LD6A-4GZQ*-□	430g
	5	RYSGW	LD6A-5GQ*-□	380g	LD6A-5GZQ*-□	470g
Wall Mount	1	R, Y, S, G, W	LD6A-1WQ*-□	225g	LD6A-1WZQ*-□	315g
	2	RY, RG	LD6A-2WQ*-□	265g	LD6A-2WZQ*-□	355g
	3	RYS, RYG	LD6A-3WQ*-□	305g	LD6A-3WZQ*-□	395g
	4	RYSG	LD6A-4WQ*-□	345g	LD6A-4WZQ*-□	435g
	5	RYSGW	LD6A-5WQ*-□	385g	LD6A-5WZQ*-□	475g
Direct Mount	1	R, Y, S, G, W	LD6A-1DQ*-□	185g	LD6A-1DZQ*-□	275g
	2	RY, RG	LD6A-2DQ*-□	225g	LD6A-2DZQ*-□	315g
	3	RYS, RYG	LD6A-3DQ*-□	265g	LD6A-3DZQ*-□	355g
	4	RYSG	LD6A-4DQ*-□	305g	LD6A-4DZQ*-□	395g
	5	RYSGW	LD6A-5DQ*-□	345g	LD6A-5DZQ*-□	435g
Pole Mount (with base)	1	R, Y, S, G, W	LD6A-1PQ*-□	645g	LD6A-1PZQ*-□	735g
	2	RY, RG	LD6A-2PQ*-□	685g	LD6A-2PZQ*-□	775g
	3	RYS, RYG	LD6A-3PQ*-□	725g	LD6A-3PZQ*-□	815g
	4	RYSG	LD6A-4PQ*-□	765g	LD6A-4PZQ*-□	855g
	5	RYSGW	LD6A-5PQ*-□	805g	LD6A-5PZQ*-□	895g
Pole Mount (with L-shaped bracket)	1	R, Y, S, G, W	LD6A-1KQ*-□	640g	LD6A-1KZQ*-□	730g
	2	RY, RG	LD6A-2KQ*-□	680g	LD6A-2KZQ*-□	770g
	3	RYS, RYG	LD6A-3KQ*-□	720g	LD6A-3KZQ*-□	810g
	4	RYSG	LD6A-4KQ*-□	760g	LD6A-4KZQ*-□	850g
	5	RYSGW	LD6A-5KQ*-□	800g	LD6A-5KZQ*-□	890g

- Specify a housing color code in place of *: B (dark gray), W (light gray)
- Select the illumination color from the top tier specifying the LED color code from the left. □ :R (red), Y (yellow), S (blue), G (green), W (pure white)

Ordering Non-Standard Products

- Order according to the table above. Specify the illumination color from the top tier.
Example: When the LED color is RYGSW => LD6A-5GQW-RYGSW

- Clear lens type also available. Specify "C" after the LED color code.
Example: LD6A-5GQW-RYSGW => LD6A-5GQW-RYSGWC

When ordering the model with a cable 500mm longer than the standard model

- Specify "-L" after the LED color code. Example: LD6A-3KZQB-RYG => LD6A-3KZQB-RYG-L

When ordering the pole mount model with L-shaped bracket Part No. LD9Z-6AK1

(different panel-cut out from standard model, as shown at right)

- Specify "1" after the housing color code. Example: LD6A-4KQB-RYSG => LD6A-4KQB1-RYSG

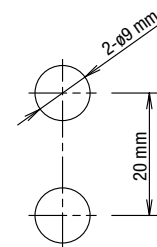

Note: Panel cut-out when using no L-shaped bracket is the same as the standard model.

Combination of LED Color and Lens Color

LED Color	Color Lens Type	Clear Lens Type
R: Red	Red lens	Clear lens
Y: Yellow	Yellow lens	Clear lens
S: Blue	Blue lens	Clear lens
G: Green	Green lens	Clear lens
W: Pure white	Clear lens	

For pure white (W) LED, a clear lens is used in both color and clear lens configurations.

Supplied Parts

Mounting Style	Supplied Parts
Frame mount	M4 screw (4 pcs)*, M4 spring washer (4 pcs)*, M4 plain washer (4 pcs)*, M5 screw (2 pcs), M5 spring washer (2 pcs), M5 plain washer (2 pcs), bracket (1 pc)
Wall mount	M4 screw (20 mm) (4 pcs), M4 screw (8 mm) (4 pcs)*, M4 spring washer (8 pcs)*, M4 plain washer (8 pcs)*, M4 nut (4 pcs), bracket (1 pc), gasket (1 pc)
Direct mount	M5 screw (4 pcs)*, M5 spring washer (4 pcs)*, M5 plain washer (4 pcs)*, M5 nut (4 pcs)*, O-ring (4 pcs), gasket (1 pc)
Pole mount (with base)	M5 screw (4 pcs), M5 spring washer (4 pcs), M5 plain washer (4 pcs), M5 nut (4 pcs), O-ring (4 pcs), gasket (1 pc)
Pole mount (with L-shaped bracket)	M22 plain washer 2 (pcs), M22 nut (2 pcs), bracket (1 pc)

* For dark gray housing, black screws and washers are supplied. For light gray housing, silver screws and washers are supplied.

Sub-assembled Products

Base Module

Package Quantity: 1

Description	Mounting Style	Part No.		Remarks
		Steady	Steady/Flashing/Alarm	
	Frame Mount	LD6A-0GQ*	LD6A-0GZQ*	A top cap is supplied.
	Wall Mount	LD6A-0WQ*	LD6A-0WZQ*	
	Direct Mount	LD6A-0DQ*	LD6A-0DZQ*	
	Pole Mount (with base)	LD6A-0PQ*	LD6A-0PZQ*	
	Pole Mount (with L-shaped bracket)	LD6A-0KQ*	LD6A-0KZQ*	

- Specify a housing color code in place of *: B (dark gray), W (light gray)
- Do not supply power to the base module without connecting LED modules.

LED Module

Package Quantity: 1

Description	Part No.	LED Color Code	Remarks
	For dark gray housing	LD9Z-6ALB-□	R, Y, S, G, W
		LD9Z-6ALB-□C	R, Y, S, G
	For light gray housing	LD9Z-6ALW-□	R, Y, S, G, W
		LD9Z-6ALW-□C	R, Y, S, G

- Specify an LED color code in place of □: R (red), Y (yellow), S (blue), G (green), W (pure white)
- When using pure white (W) with a clear lens, order LD9Z-6ALB-W (dark gray housing) or LD9Z-6ALW-W (light gray housing).

Center Screw Set





Description	Part No.	Remarks
 Material: SWRM3 (trivalent chromate)	1 tier	LD9Z-6AC1
	2 tiers	LD9Z-6AC2
	3 tiers	LD9Z-6AC3
	4 tiers	LD9Z-6AC4
	5 tiers	LD9Z-6AC5

A plain washer and a spring washer are supplied.

Ordering Examples

- [Ex. 1] When ordering LD6A-3PQW-RYG as sub-assembled parts, specify the following parts:
Pole mount (with base), steady, light gray housing, 3 tiers, color lens LED modules with Red, Yellow, and Green LED
- | | | |
|--|-------------|---------|
| Base module (pole mount with base, steady, light gray housing) | LD6A-0PQW | 1 piece |
| LED module (red LED with color lens, light gray housing) | LD9Z-6ALW-R | 1 piece |
| LED module (yellow LED with color lens, light gray housing) | LD9Z-6ALW-Y | 1 piece |
| LED module (green LED with color lens, light gray housing) | LD9Z-6ALW-G | 1 piece |
| Center screw set (3 tiers) | LD9Z-6AC3 | 1 piece |
- [Ex. 2] When ordering LD6A-5WZQB-RYSGWC as sub-assembled parts, specify the following parts:
Wall mount, steady/flashing/alarm, dark gray housing, 5 tiers, clear lens LED modules with Red, Yellow, Blue, Green, and Pure white LED
- | | | |
|--|--------------|---------|
| Base module (wall mount, steady/flashing/alarm, dark gray housing) | LD6A-0WZQB | 1 piece |
| LED module (red LED with clear lens, dark gray housing) | LD9Z-6ALB-RC | 1 piece |
| LED module (yellow LED with clear lens, dark gray housing) | LD9Z-6ALB-YC | 1 piece |
| LED module (blue LED with clear lens, dark gray housing) | LD9Z-6ALB-SC | 1 piece |
| LED module (green LED with clear lens, dark gray housing) | LD9Z-6ALB-GC | 1 piece |
| LED module (pure white LED with clear lens, dark gray housing) | LD9Z-6ALB-W | 1 piece |
| Center screw set (5 tiers) | LD9Z-6AC5 | 1 piece |

Accessories

Description	Part No.	Remarks
Top Cap (ABS resin) 	For dark gray	LD9Z-6ATB
	For light gray	LD9Z-6ATW
Mounting Screw Set  Photo: For direct mount/dark gray	For frame mount/dark gray	LD9Z-6AGB
	For frame mount/light gray	LD9Z-6AGW
	For wall mount/dark gray	LD9Z-6AWB
	For wall mount/light gray	LD9Z-6AWW
	For direct mount/dark gray	LD9Z-6ADB
	For direct mount/light gray	LD9Z-6ADW
Round Base (Set Screw) 	LD9Z-6AP	Round base (1 pc), M4 hexagon socket set screw (2 pcs)
L-shaped Bracket 	LD9Z-6AK	M22 plain washer (2 pcs), M22 nut (2 pcs), bracket (2-φ11 panel cut-out, 35mm mounting centers) (1 pc) are supplied.
	LD9Z-6AK1	M22 plain washers (2 pcs), M22 nut (2 pcs), bracket (2-φ9 panel cut-out, 20mm mounting centers) (1 pc) are supplied.

*For dark gray housing, black screws and washers are supplied. For light gray housing, silver screws and washers are supplied.

Download catalogs and CAD from <http://asia.idec.com/downloads>

APEM

Switches & Pilot Lights

Control Boxes

Emergency Stop Switches

Enabling Switches

Safety Products

Explosion Proof

Terminal Blocks

Relays & Sockets

Circuit Protectors

Power Supplies

LED Illumination

Controllers

Operator Interfaces

Sensors

AUTO-ID

Flush Silhouette

φ16

φ22

φ30

Miniature

Pilot Lights

HW1Z

AP22

A Series

LD6A

B-400

LD6A LED Signal Lights

Dimensions (Steady)

All dimensions in mm.

Frame Mount

Wall Mount

Direct Mount

Pole Mount
(with base)

Pole Mount
(with L-shaped bracket)

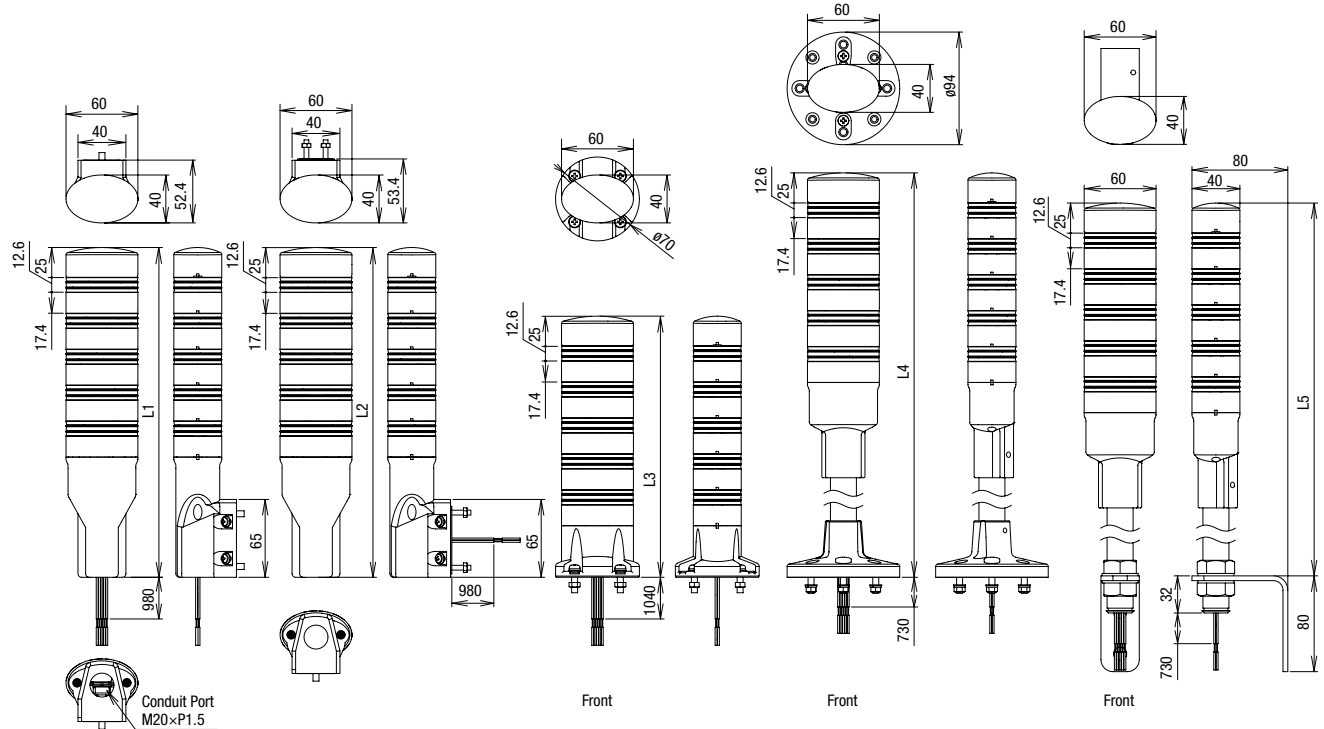

Dimension Table

Dimensions in mm.

Tiers	Frame Mount (L1)	Wall Mount (L2)	Direct Mount (L3)	Pole Mount	
				w/ base (L4)	w/ L-shaped bracket (L5)
1	156	156	98	408	372
2	186	186	128	438	402
3	216	216	158	468	432
4	246	246	188	498	462
5	276	276	218	528	492

Panel Cut-Out

Frame Mount

Wall Mount

Direct Mount*

Pole Mount (with base)

Pole Mount
(with L-shaped bracket)

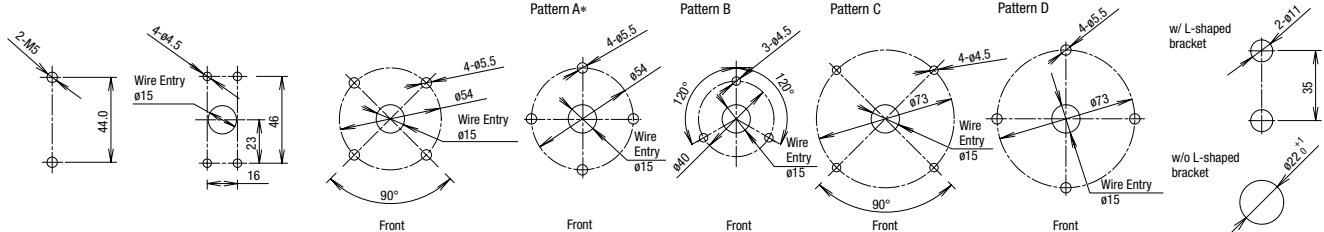

Dimensions in mm.

*Complies with IEC 60947-5-1.

Wiring Example (Steady)

Mechanical Contacts

NPN Transistors

PNP Transistors

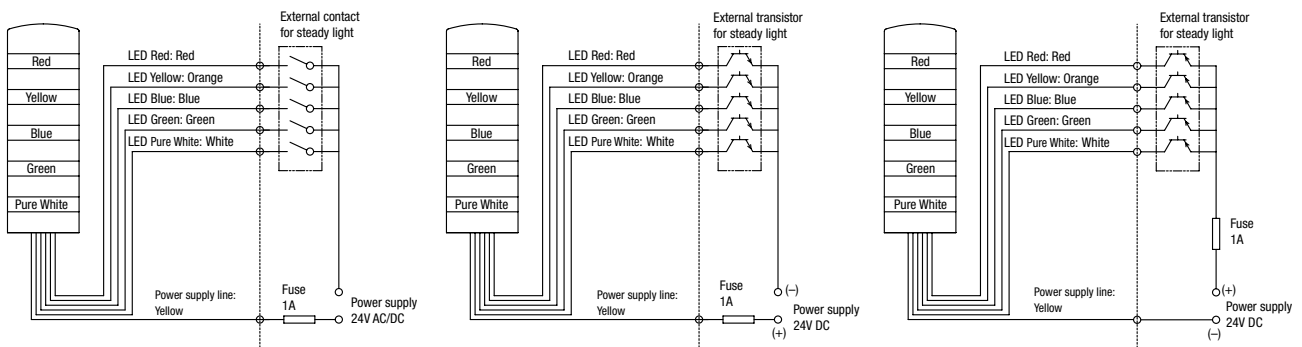

Dimensions (Steady/Flashing/Alarm)

All dimensions in mm.

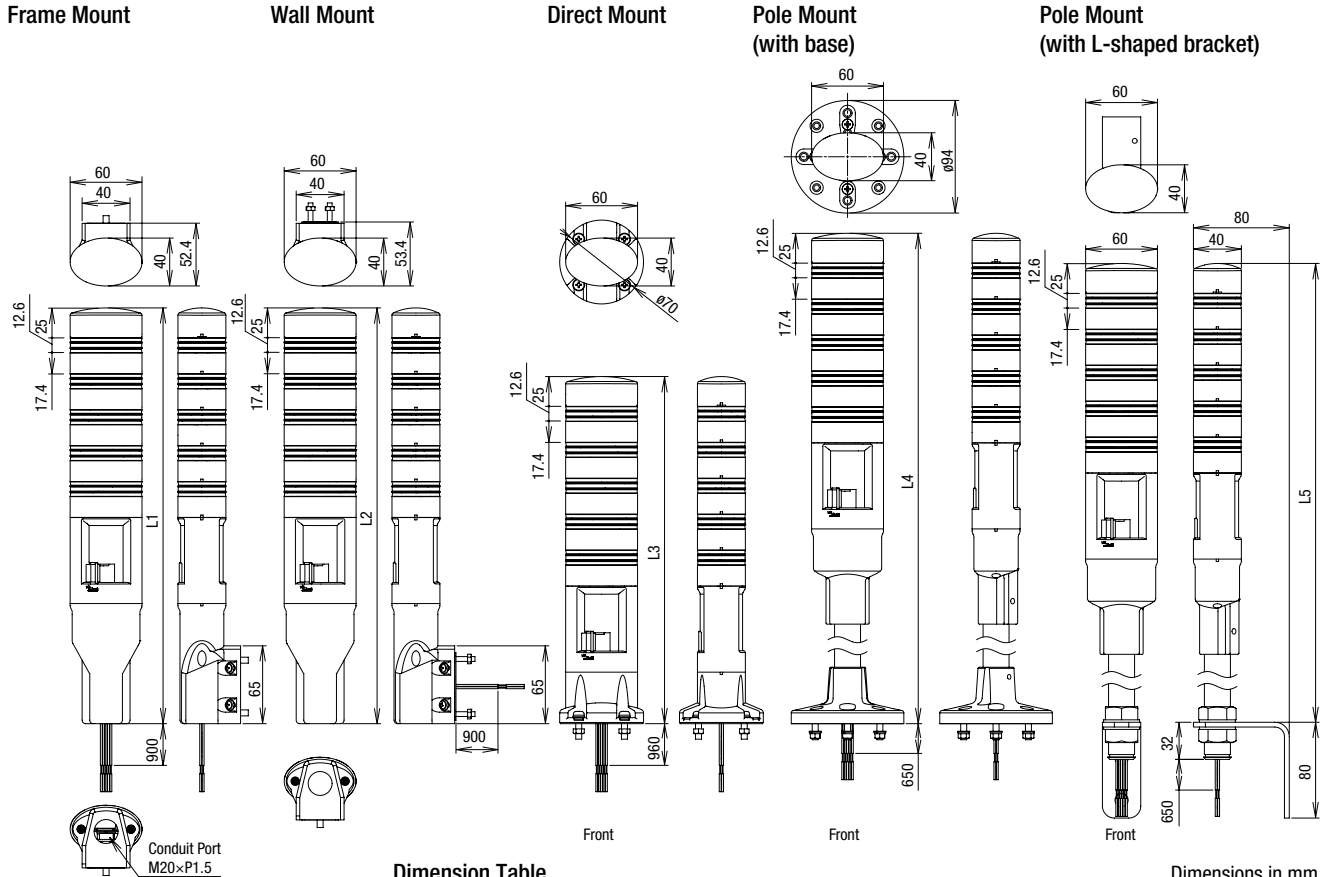

Dimension Table

Dimensions in mm.

Tiers	Frame Mount (L1)	Wall Mount (L2)	Direct Mount (L3)	Pole Mount	
				w/base (L4)	w/L-shaped bracket (L5)
1	228	228	170	480	444
2	258	258	200	510	474
3	288	288	230	540	504
4	318	318	260	570	534
5	348	348	290	600	564

Panel Cut-Out

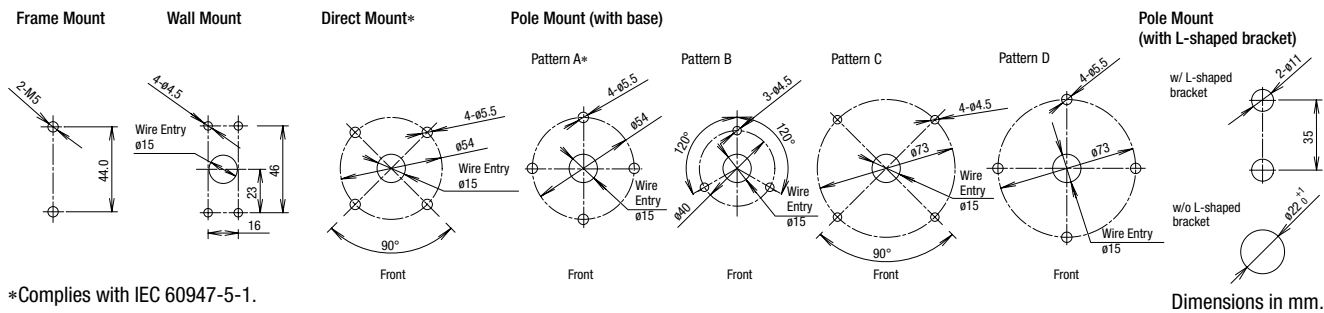

*Complies with IEC 60947-5-1.

Wiring Example (Flashing and Alarm)

Mechanical Contacts

NPN Transistors

PNP Transistors

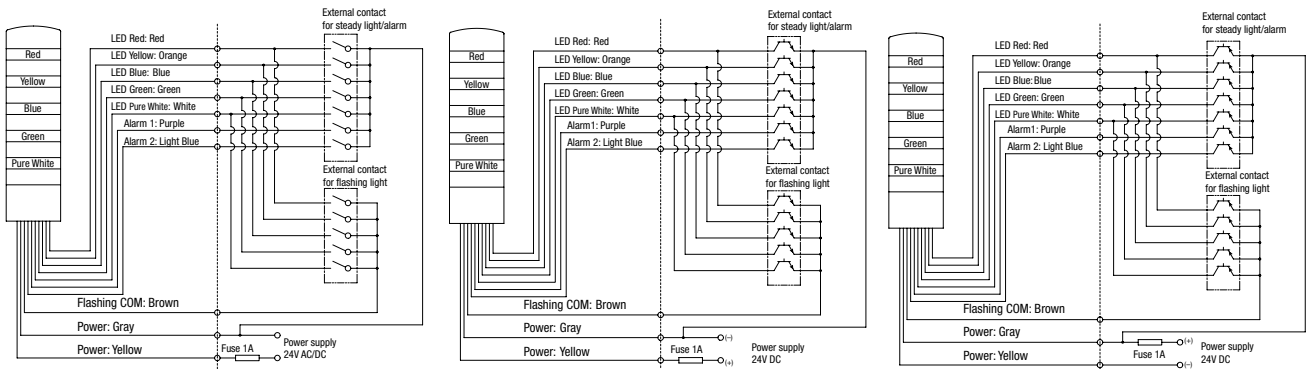

- APEM
- Switches & Pilot Lights
- Control Boxes
- Emergency Stop Switches
- Enabling Switches
- Safety Products
- Explosion Proof
- Terminal Blocks
- Relays & Sockets
- Circuit Protectors
- Power Supplies
- LED Illumination
- Controllers
- Operator Interfaces
- Sensors

- AUTO-ID
- Flush Silhouette
- ø16
- ø22
- ø30
- Miniature
- Pilot Lights
- HW1Z
- AP22
- A Series

⚠ Safety Precautions

- Turn off the power to the LD6A before mounting, dismantling, wiring, and assembling the LED module. Make sure of correct wiring, otherwise electrical shocks or fire hazard may result.
- Mount the LD6A on a solid surface not subjected to vibrations.
- Do not mount the LD6A upside-down or horizontally.
- Do not leave the LD6A without a cap or unassembled.
- Install the supplied gasket, otherwise the waterproof characteristic is impaired.
- Do not apply any chemicals which may corrode the plastic materials.

- If the LD6A is subjected to strong vibrations, the hexagon socket screw may become loose. Take measures to prevent loosening. (See the figure below.)

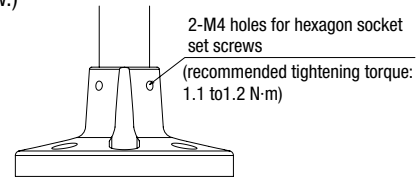

- Do not loosen a screw for which the tightening torque is not specified.

Operating Instructions

Mounting

- See drawing below on mounting of the LD6A.
- For panel cut-out, see **B-401** and **B-402**.
- Face the LD6A to the front to make sure the alarm sound is clear. (Steady/flashing/alarm)

Frame Mounting

1. Insert two nuts in the frame, and attach the bracket using two M5 screws.
Recommended tightening torque: 2.6 to 2.7 N-m
2. Mount the LD6A to the bracket using four M4 screws.
Recommended tightening torque: 1.6 to 1.7 N-m

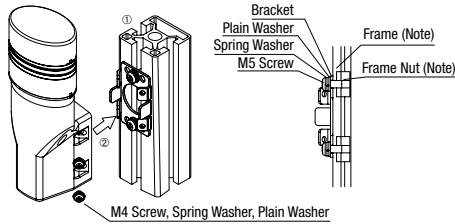

Note: See table below for typical examples of frames and nuts. Consult the manufacturer of the frame for the installation method of the frame nut.

Examples of recommended frames and frame nuts

Frame Size	Frame	Frame Nut	Manufacturer
□30 mm (Note)	SFF-302	SFB-001 SFB-4B5 SFB-101	SUS Corporation (Japan)
□40 mm	SFF-402	SFB-008 SFB-4A5 SFB-108	

Note: The mounting bracket for the housing is 40 mm.

When using a frame mount type, be sure to use flexible conduit, otherwise the waterproof characteristic is impaired. Refer to the "Example of Flexible Conduit" shown on the right.

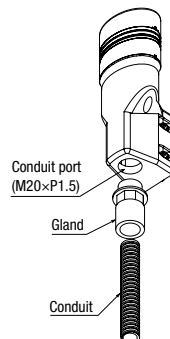

Example of Flexible Conduit

Conduit Port Size	M20
Gland	AL16/M20/A/BL
Conduit	PAFS16BL
Manufacturer	Adaptaflex

Wall Mounting

1. Make four tapped holes in the mounting panel and mount the bracket and gasket using four screws (M4 x 20).
Recommended tightening torque: 1.6 to 1.7 N-m
2. Mount the LD6A to the bracket using four screws (M4 x 8).
Recommended tightening torque: 1.6 to 1.7 N-m

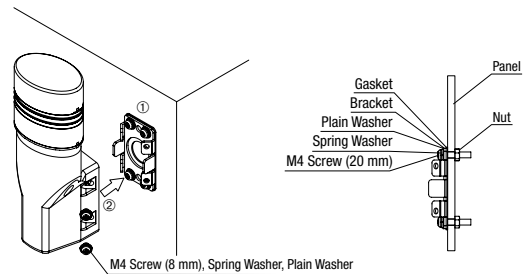

Direct Mounting

- Recommended tightening torque: 2.6 to 2.7 N-m

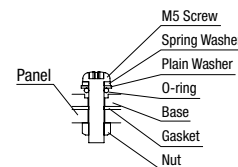

Pole Mounting (with base)

The pole mount type can be installed in four ways. The recommended mounting method (pattern A) is described below.
Recommended tightening torque: 2.6 to 2.7 N-m (M5 screw)

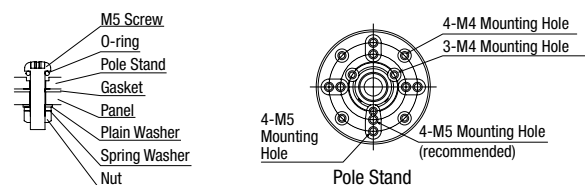

Pole Mounting (with L-shaped bracket)

1. When L-shaped bracket is used
Recommended tightening torque: 10 to 11 N-m (M10)
Recommended tightening torque: 25 to 26 N-m (M22)
2. When L-shaped bracket is not used
Remove the bushing, hexagonal nut (M22), plain washer, and L-shaped bracket from the LD6A and install in order of plain washer, hexagonal nut (M22), and bushing.
Recommended tightening torque: 25 to 26 N-m (M22)

1. When L-shaped bracket is used 2. When L-shaped bracket is not used

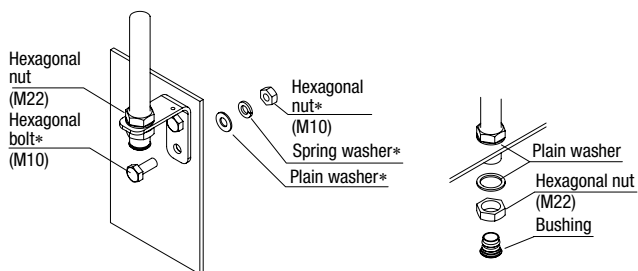

The parts marked with * are not supplied and should be prepared by the user.
The screw size depends on the L-shaped bracket size, as shown below.
When using LD6A-□K□Q□-***** => M10
When using LD6A-□K□Q□1-***** => M8

Replacement/Expansion/Reduction of LED Modules

- Make sure to turn power off.
- When expanding/reducing the LED modules, make sure to use the center screw set of the correct length.
- Insert a flat screwdriver into the recess as shown below, lift up the cap, and remove the cap with your hands. Use a flat screwdriver with a tip of 1-mm thick and 7-mm wide maximum.
- Remove the center screw before reassembling the LED modules.
- When assembling the LED modules, make sure to align the recess of the cap with the recess of the LED module. Otherwise, damage may result.

Recommended tightening torque: 0.4 to 0.5 N·m.

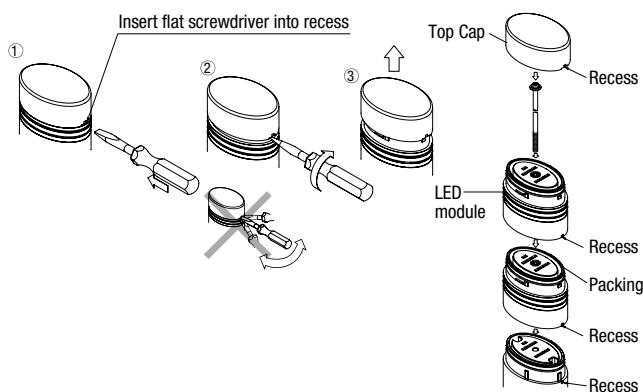

- Note the correct orientation when assembling the LED modules.
- Tighten the screws to the recommended tightening torque. The LED module may be damaged if the screw is loose during operation.
- Do not touch the metal plug on the LED module. Otherwise, LED elements may be damaged due to static electricity.
- Use a maximum of 5 tiers.
- Select an optional screw of an appropriate length depending on the number of tiers.
- Do not remove the packing from the LED module. Otherwise, waterproof characteristics will be impaired.

Wiring

- For wiring, see the wiring diagrams on **B-401** and **B-402**.
- Incorrect wiring may damage the internal circuit.
- Be sure to insulate unused wires.
- Connect a 1A fuse to the power line as shown in the Wiring Examples on **B-401** and **B-402**.
- Use a UL listed external fuse holder.
- Use a class 2 power supply only.
- When using LED modules of the same color for two or more tiers, determine contact capacity in consideration of the LED current, because only one wire is used to light all tiers of the same color.
- Do not apply voltage to flashing (brown) lines.
- Do not connect flashing (brown) lines with the power lines. The internal circuit may be damaged.
- Do not turn on steady and flashing lines simultaneously.
- Do not turn on alarms 1 and 2 simultaneously.

Wire Color

Wire Color	Steady	Steady, Flashing, Alarm
Red	LED Module – Red	LED Module – Red
Orange	LED Module – Yellow	LED Module – Yellow
Blue	LED Module – Blue	LED Module – Blue
Green	LED Module – Green	LED Module – Green
White	LED Module – Pure White	LED Module – Pure White
Purple	—	Alarm 1
Light Blue	—	Alarm 2
Brown	—	Flashing COM
Gray	—	Power Line
Yellow	Power Line	Power Line

- For information on external contacts, see “External Contact Ratings” on **B-398**.

Sound Volume Adjustment

- Move the sound volume lever to the right and left to adjust the sound volume.
- The sound volume is at maximum when the lever is set to the right.
- The sound volume adjustment lever may be damaged if forcibly moved.

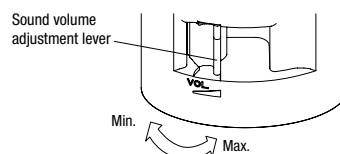

Highest Temperature Limitations

The highest temperature is limited to 50°C when all tiers are lit continuously in the following combinations:

1. Three tiers
Two or more tiers of blue and green
(example: Red-Green-Blue, Green-Green-Red)
2. Four or five tiers
(example: Red-Yellow-Green-Pure White,
Red-Yellow-Blue-Green-Pure White)

APEM

Switches & Pilot Lights

Control Boxes

Emergency Stop Switches

Enabling Switches

Safety Products

Explosion Proof

Terminal Blocks

Relays & Sockets

Circuit Protectors

Power Supplies

LED Illumination

Controllers

Operator Interfaces

Sensors

AUTO-ID

Flush Silhouette

ø16

ø22

ø30

Miniature

Pilot Lights

HW1Z

AP22

A Series

LD6A

