



Tablet mount safety device
HT4P



Safety Commander™

Enable industrial tablets to provide operation safety
Complies with safety requirements as required by the
ISO 10218 series.



IDEC CORPORATION

Mechanical switches

NEW

- Up to 3 IDEC LB series switches can be installed. (*1)
- Reliable operation.
- Ideal for a wide range of applications. Complies with various standards.

*1) The product will be shipped with requested switches. See P7 for custom products.

Standard products

- Without mechanical switch



Custom products (example)

- TS series joystick



Custom products (example)

- Illuminated pushbuttons (red)
- Illuminated pushbuttons (green)
- Key selector switch



Emergency stop switch with LED indicator

Equipped with a safety lock mechanism, safe break action structure, and direct opening action.

NEW

Emergency stop switch guard (accessory)

Retrofittable guards available.



USB/LAN converter with built-in USB power delivery

NEW

- Wired LAN enables stable communication regardless of the environment.
- USB power delivery allows battery charge via USB while communicating. No need to worry about the battery running out.



NEW

HT4P

High performance

Wired LAN

Mechanical switch

10 to 13 inches

Vertical and horizontal operation for flexible use

Ergonomic design for improved operability

- Rotating grips allow the tablet to be used in vertical or horizontal orientation. The emergency stop switch, which must be accessed instantly, can also be positioned for ease of use.
- Easy to hold and operate, regardless of handedness. The ergonomic holder design and enabling switch position result in ease of holding and operability.



Safety device easily attaches to a 10- to 13-inch tablet

NEW

- The tablet can be readily equipped with a safety device.



Tablet



HT4P Safety Commander™

- Equipped with slide mechanism.
- Fits large and rugged tablets.



10 inches



13 inches

Three-position enabling switch

Safety during work operations is assured by the ergonomically designed three-position action to avoid danger.

Note: ISO 10218 series specifies the requirement for the installation of the three-position enabling switch on the teaching pendant.



Can be used set down

Enables stable operation while placed on a desk.

Note.) Excludes operation of enable switches.

Rotation unlock button

NEW

Allows the grip to rotate only when the button is pressed, preventing unintentional rotation.

Hand strap or shoulder strap (accessories)

- Prevents the product from dropping during hand-held operation.
- Reduces the burden when working long hours.



- The shoulder strap has a safety feature that disengages when a certain load is applied.

Rugged construction with drop resistance of 1.2m

Designed for assurance, the product has passed drop tests assuming accidental drop or impact while carrying. (*)



*) Drop resistance has been tested for tablet weights up to 1.1 kilogram.

Note: Drop protection of the product or tablet is not guaranteed.

IP54 protection

Usable even in dusty environments or when exposed to splashing or spraying.



Safety Commander™

Patent pending

Expansion lock

Prevents unintentional removal of the tablet.

Expansion lock lever

Locks the extension of the tablet holder.



Movable mounting hooks & spacers

NEW

The power and audio buttons on the tablet can be operated when mounted, as bracket and spacer positions can be changed.

- Mounting bracket position can be changed.



- Mounting spacer position can be changed.



Waterproof connector/

NEW

Wired LAN, switch contact, power supply cable (accessories)

- Connector allows one-touch connection and disconnection of the cable.
- Easy maintenance.



Wall mount

Wall mount bracket (accessory) enables operation while fixed to the wall.

Note: Only for operations that do not require an enabling switch.



Customer benefits

Improved safety of tablets

BEFORE

- || Devices can be controlled by only using tablets.
- || Safety is not ensured without safety devices.
- || Does not satisfy safety standards.
- || Wireless features are affected by noise.



AFTER

- || Improved safety with safety devices.
- || Complies with international safety standards.
- || Wired LAN enables safe communication.



Eliminates the need to develop a dedicated device

BEFORE

- || Large development and production costs.
- || Difficult to handle discontinuation of parts.
- || Complex operation due to too many buttons.



AFTER

- || No hardware development required. Software only.
- || Low cost.
- || Easy to operate.



Replacement for a touch panel on a control panel

BEFORE

- || Individual touch panels are installed on multiple panel boards.

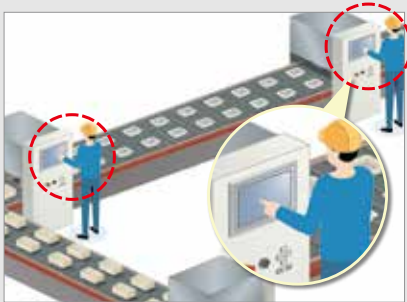

AFTER

- || One Safety Commander can be used in multiple locations.
- || Cost reduction and space saving of control panel.
- || Reduced number of touch panels.



Enables operation close to the machine

BEFORE

- || Fixed touch panels are used to control large machines.
- || Multiple workers call out to each other during maintenance.

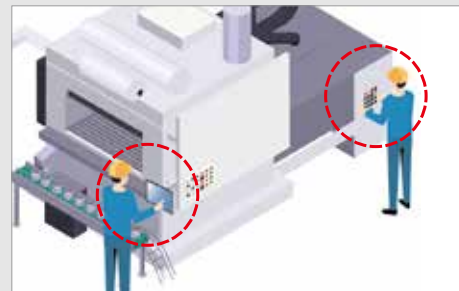

AFTER

- || By using the product together with a fixed touch panel, machines can be operated using the web browser and remote desktop functions.
- || Workers can operate close to the machine and the number of workers can be reduced.



Applications

Robot teaching



Large equipment and machinery



Automotive production lines and conveyor lines



Semiconductor manufacturing equipment, chip mounter, food & packaging equipment



AGV and AMR



HT4P Safety Commander™

 • See website for details on approvals and standards.

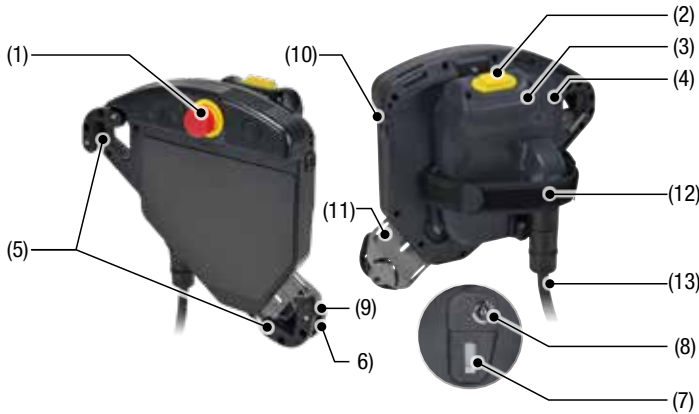





No.	Name	Description
(1)	Emergency stop switch	XA1E-LV302Q4R (IDEC)
(2)	Enabling switch	HE6B-M200Y (IDEC)
(3)	Grip unit	Grip of the product
(4)	Tablet holder unit	Secures the tablet
(5)	Hook top	—
(6)	Hook base	—
(7)	Expansion lock lever	Extendable lever for tablet holder
(8)	Expansion lock	Key lock for extendable lever (includes 2 extendable lock release keys)
(9)	Spacer	—
(10)	USB port	Type-C
(11)	Slide arm	—
(12)	Hand strap	Supplied with the product
(13)	Cable	Accessory (sold separately)

HT4P Safety Commander™











Package Quantity: 1

Name	Tablet compatible size	Part No.	Remarks
HT4P Safety Commander™	10 to 13 inches	HT4P-SLNP	Switches used: Emergency stop switch XA1E-LV302Q4R (IDEC) Enabling switch HE6B-M200Y (IDEC) See page 7 for part no. of custom products installed with mechanical switches.
		HT4P-SLSPL-R****	See page 7 for details on mechanical switch mount model.

Maintenance parts (sold separately)

Name	Shape	Specification	Part No.	Quantity	Remarks
Hand strap		PP, others	HT9Z-4PS1	1	Back hand hold type
Extendable lock release key		Metal (brass)	HT9Z-4PK01	1	Includes 2 pieces
Hook (Supplied)		Hook top: Rubber Hook base: Plastic Spacer: Aluminum Rubber tube: Rubber	HT9Z-4PHZ1	1	Hook to secure the tablet (Hook top, hook base, 2 spacers (14mm) 2 rubber tubes (8mm), rivet)
Hook top (Supplied)		Rubber	HT9Z-4PHZ1-F	1	Includes 2 pieces

Accessories (sold separately)

Name	Shape	Specification	Part No.	Quantity	Remarks
Tablet thickness adjustment kit A		Spacer: aluminum Rubber tube: rubber	HT9Z-3PHB08	4 spacers 4 rubber tubes	Use with standard parts for tablet with thickness of 9 to 17mm
Tablet thickness adjustment kit B		Spacer: aluminum Rubber tube: rubber	HT9Z-3PHB14	4 spacers 4 rubber tubes	Use with standard parts for tablet with thickness of 17 to 23mm
Rubber tube		Rubber	HT9Z-3PHC10	1	For tablet thickness adjustment Approx. 100mm (inside diameter ø6mm, external diameter ø9mm) • Cut to length when aluminum spacers are provided by customer. For details see the "12. Options/Maintenance parts" *16 and *17 on the instruction sheet.
Shoulder strap		PP, others	HT9Z-4PS2	1	Shoulder strap For safety reasons, if the strap holds more than a certain amount of load, the strap will fall off.
Cable (5m) D-sub37p		Double-shielded cable 25 cores	HT9Z-4PC15MC	1	D-sub37 pin (plug) (mating screw: #4-40 inch screw)
Cable stranded wire		Power supply: AWG20 Others: AWG24	HT9Z-4PC1*M	1	Stranded wire type, length (m) *: 5, 10, 15, 20
Emergency stop switch		Plastic	HT9Z-4PG1	1	Screws for mounting emergency stop switch guards: Two M3 × 8 mm countersunk tapping screws
Wall mount bracket		Aluminum	HT9Z-4PF1	1	The main unit can be fixed to a wall. The mounting centers of the screws complies with VESA standard.
Hook (*1)		Hook top: Rubber Hook base: Plastic Spacer: Aluminum Rubber tube: Rubber	HT9Z-4PHZ	1	Hook to secure the tablet (Hook top, hook base, 2 spacers (14mm) 2 rubber tubes (8mm), rivet)
Hook top (*1)		Rubber	HT9Z-4PHZ-F	1	Includes 2 pieces











*1) Holds the tablet more firmly compared to the hooks supplied with the tablet. However, depending on the tablet used, a part of the hook may get in the way of the screen. For the actual size, see the dimensions on the website.

- If the rivet is damaged, purchase the rivet from Hirotsugi-Keiki, Part Number N-4060

Mechanical switch mount model (custom order)

The following IDEC LB series mechanical switches can be installed on the HT4P as custom products.

Package Quantity: 1

Part No.	Mounting position			Mounting image
	(1)	(2)	(3)	
HT4P-SLSPL-R0001	-	-	Selector switch 2-position / 2NO contact / maintained / knob operator LB6S-2T2	
HT4P-SLSPL-R0002	-	-	Selector switch 3-position / 2NO contact / maintained / knob operator LB6S-3T2	
HT4P-SLSPL-R0003	-	-	Key selector switch 2-position / 2NO contact / maintained / disk tumbler key LB6K-2T2A	
HT4P-SLSPL-R0004	-	-	Key selector switch 3-position / 2NO contact / maintained / disk tumbler key LB6K-3T2A	
HT4P-SLSPL-R0005	Illuminated pushbuttons Red / 1NO contact / momentary LB6L-M1T14R	Illuminated pushbuttons Green/1NO contact/ momentary LB6L-M1T14G	Key selector switch 3-position / 2NO contact / maintained / disk tumbler key LB6K-3T2A	
HT4P-SLSPL-R0006	Illuminated pushbuttons Red / 1NO contact / momentary LB6L-M1T14R	Illuminated pushbuttons Green/1NO contact/ momentary LB6L-M1T14G	Selector switch 2-position / 2NO contact / maintained / knob operator LB6S-2T2	
HT4P-SLSPL-R0007	Illuminated pushbuttons Green/1NO contact / momentary LB6L-M1T14G	-	Key selector switch 3-position / 2NO contact / maintained / disk tumbler key LB6K-3T2A	
HT4P-SLSPL-R0008	Illuminated pushbuttons Green / 1NO contact / momentary LB6L-M1T14G	-	Selector switch 2-position / 2NO contact / maintained / knob operator LB6S-2T2	
HT4P-SLSPL-R0009	Pushbuttons White / 1NO contact / momentary LB6B-M1T1W	Pushbuttons White / 1NO contact / momentary LB6B-M1T1W	Selector switch 2-position / 2NO contact / maintained / knob operator LB6S-2T2	
HT4P-SLSPL-R0010	Pushbuttons Black / 1NO contact/ momentary LB6B-M1T1B	Illuminated pushbuttons Green / 1NO contact/ momentary LB6L-M1T14G	Selector switch 2-position / 2NO contact / maintained / knob operator LB6S-2T2	

• Contact IDEC for combinations other than those listed above.

Mechanical switch mount position



Wiring example

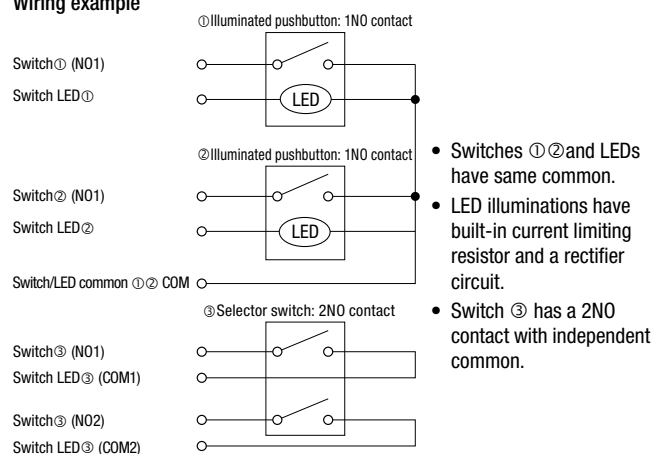

Through power output function (custom product)

Available soon

- Suitable for tablets that are powered with DC power jacks.
- Available with a through power output terminal that can directly supply power from the cable to the tablet.



General specifications

Environmental Specifications	Operating temperature (*3)		-10 to +55°C (when USB is not connected / product is not held) -10 to +40°C (when connected to USB / product is not held) -10 to +35°C (*4) (when product is held) (no freezing)	
	Storage temperature		-20 to +55°C (no freezing)	
	Storage humidity		45 to 85%RH (no condensation)	
	Operating humidity		45 to 85%RH (no condensation)	
	Degree of pollution		3	
	Rated insulation voltage		50V	
Electrical Specifications (*1) (*2)	Overvoltage category		II	
	Rated input voltage		Main power supply: 24V DC (20.4V to 28.8V DC) Emergency stop switch LED unit: 24V DC (21.6V to 26.4V DC) Mechanical switch LB series LED unit: 24V DC (21.6V to 26.4V DC)	
	Current draw		Main power supply: 2.0A max. Emergency stop switch LED unit: 11mA Mechanical switch LB series LED unit: 5mA	
	Allowable momentary power interruption		1ms	
	Dielectric strength		Main power supply 24V DC between +/- terminals and FE terminal: 500V AC for 1 min.	
	Insulation resistance		Main power supply 24V DC between +/- terminals and FE terminals: 100MΩ min. (500V DC megger)	
	Contact ratings (*5)	Emergency stop switch XA1E-LV302Q4R (Illuminated) (*6)	2A / 30V DC (resistive load) 1A / 30V DC (inductive load)	
		Enabling switch HE6B-M200Y (6)	1A / 30V DC (resistive load) 0.7A / 30V DC (inductive load)	
		Mechanical switch LB series (*6)	0.1A / 30V DC (resistive load)	
	EMC Specifications	Immunity zone	Zone A (IEC/EN 61131-2)	
	Mechanical specification	Vibration resistance		5 to 8.4Hz: amplitude 3.5mm 8.4 to 150Hz : acceleration 9.8m/s ² (3 directions, 2 hours each)
		Shock resistance		147m/s ² 11ms (5 times each in 6 directions)

Structure Specification	Degree of protection		IP54 (*7)
	Compatible tablet (*8)	Compatible tablet size	Tablet diagonal length : 290 to 380mm (270mm~ at reduced size) Screen size: 10 to 13 inches
		Compatible tablet thickness	Standard : up to 9mm (*9)
		Compatible OS	(*11)
	Compatible tablet weight	Max. 1.1kg (reference value)	
	Weight (approx.) (*10)		Approx. 880g Approx. 2210g (Cable, including accessory / D-Sub type)
Grip unit rotation angle		Approx. 120° (approx.)	
Housing color		Black	
USB	Communication	USB 2.0 device High speed (480Mbps)	
	Power supply	USB PD Source Output: 30W 5V-3A, 9V-3A, 15V-2A, 20V-1.5A	
	Cable	USB Type C connector Cable length: 0.5m max.	
Ethernet (*12)	Communication method	IEEE802.3i 10BASE-T, 100BASE-TX	
	Internal circuits and insulation	Pulse transformer	
Applicable standards	Safety standards		IEC/EN 60947-5-1 IEC/EN 60947-5-5 (XA1E-LV302Q4R) IEC/EN 60947-5-8 (HE6B-M200Y) UL 508 UL 60947-1 UL 60947-5-1 UL 60947-5-5 CSA C22.2 No.14
	Applicable standards for use		ISO 12100 IEC 60204-1 ISO 10218-1 ISO 10218-2
	EMC standards		IEC/EN 61131-2
	UL certification		UL508 UL60947-5-5 CSA C22.2 No.14

*1) If there is a risk of malfunction or destruction to the USB power supply or tablet due to noise from the connected power supply, use a dedicated USB power supply that is independent of other power supplies. Use Class2 or SELV power supply. This product does not support hot swap, so wiring should be done while the power supply to be connected is OFF.

*2) The emergency stop switch and LB series mechanical switch has a built-in current limiting resistor and a rectifier circuit.

*3) When using the product under operating temperature of more than 40°C, follow the instructions mentioned in "4. Specifications" *13 on the instruction sheet.

*4) The tablet holder unit generates heat when power is supplied for a long period of time. Do not supply power while holding the tablet holder unit for a long period of time as it may cause low-temperature burns.

*5) Specifications for components.

*6) UL certified rating
Emergency stop switch / Enabling switch: 30VDC / 1A max. (Res), 30V / 0.7A max. (Pilot Duty)
Mechanical switch: 30V / 0.1A max. (Res)

*7) Not when USB cable is connected.

*8) May not be applicable depending on the shape. Weight is not guaranteed.

*9) Tablet thickness can be adjusted up to 23mm with the accessory tablet thickness adjustment kit. Use HT9Z-3PHB08 for tablet thickness of 9mm to 17mm and HT9Z-3PHB14 for tablet thickness of 17mm to 23mm by adding them to the standard parts.

*10) Except hand straps and other accessories.

*11) See "USB to Ethernet Conversion Function" below for details.

*12) USB to Ethernet Conversion Function
USB-Ethernet conversion function can be used by installing a dedicated software driver on a Windows tablet.
This function is available using MAXLINEAR's dedicated IC (model number: XR22801).
The dedicated software driver can be downloaded from the MAXLINEAR website below and should be used in accordance with the conditions of use described on the website. Check the following website for supported OS and versions.
<https://www.maxlinear.com/support/design-tools/software-drivers>
Before using the software, check the Errata information from the following website and handle the software according to the information.
<https://www.maxlinear.com/product/interface/bridges/usb-ethernet-bridges/xr22801#documentation>

Dimensions

Main parts

All dimensions in mm.

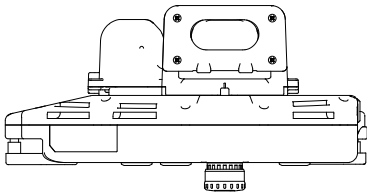

Emergency stop switch
Part no.: XA1E-LV302Q4R (IDEC)

Enabling switch
Part no.: HE6B-M200Y (IDEC)

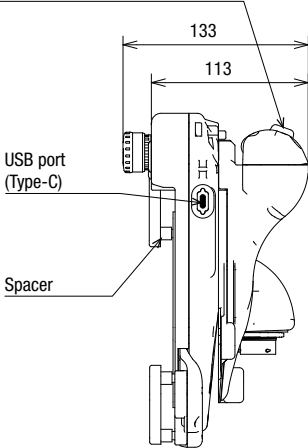
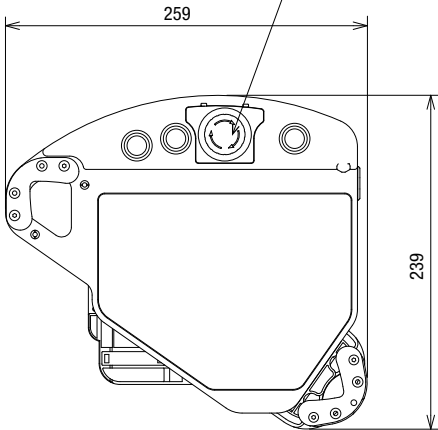

Minimum expansion

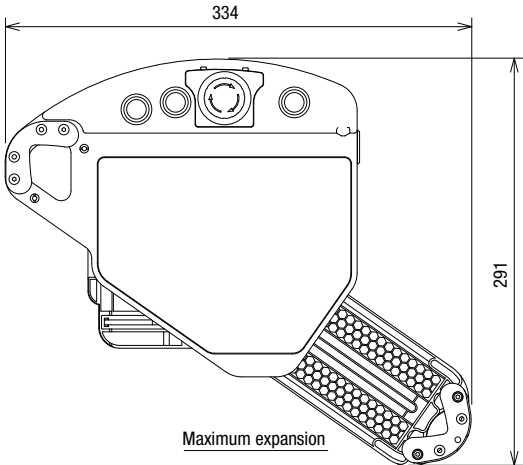

Maximum expansion

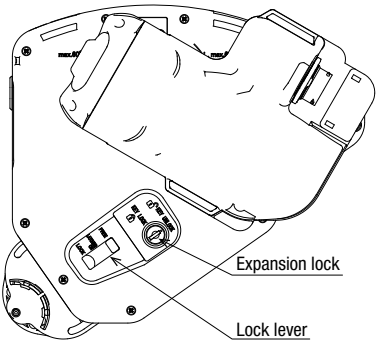
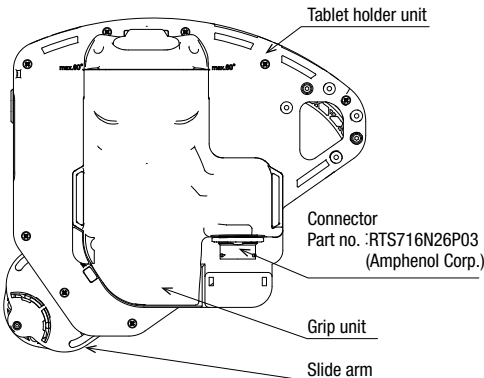
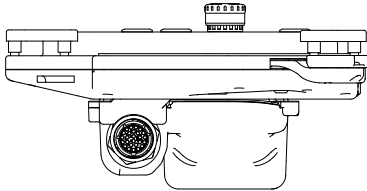

External interface

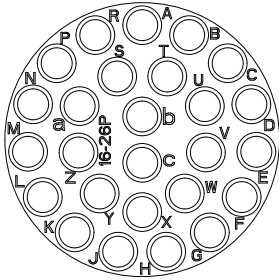

Connector (HT4P side)

Manufacturer : Amphenol Corp.
Type No.: RTS716N26P03

When preparing cables by the customer

- 1) Cables smaller than AWG20 cannot be connected to the main power supply. Use cables larger than AWG20.
- 2) Use cables with transmission characteristics equivalent to LAN cables of Category 5e or higher for Ethernet wiring, and shield the entire Ethernet cable with a shield. (Internal shield)
- 3) In addition to the cables for the main power supply, the emergency stop switch and enabling switch, and the entire shielded Ethernet cable should be further shielded. (External shield)

HT4P side connector code	Cable core color (*1)	D-sub37p pin no. (*2)	Function name	HT4P-SLNPL (Standard stock)	HT4P-SLSPL-R * (Mechanical switch installed)
A	Black	1	Main power supply	24V DC+	24V DC
B	White	2		24V DC-	24V DC
C	Shield (External/Internal)	21		FE terminal	FE terminal
D	Blue	5	Ethernet	TPO + (sent data +)	TPO + (sent data +)
E	White/Blue	6		TPO- (sent data -)	TPO- (sent data-)
F	Orange	7		TPI + (received data +)	TPI + (received data +)
G	White/Orange	8		TPI- (received data -)	TPI- (received data -)
H	Blue	11	Mechanical switch	-	Switch Ⓞ (NO1)
J	Gray	12		-	Switch Ⓞ (COM1)
K	Orange	13		-	Switch Ⓞ (NO2)
L	Purple	14		-	Switch Ⓞ (COM2)
M	Pink	15		-	Switch Ⓞ (NO1)
N	Light green	16		-	Switch Ⓞ (NO1)
P	White/Red	17		-	For switch LED Ⓞ (24V DC)
R	White/Green	18		-	For switch LED Ⓞ (24V DC)
S	White/Yellow	19		-	Switch · LED common ⓄⓄCOM
T	White/Brown	27	Emergency stop switch	LED (X1)	LED (X1)
U	White/Blue	28		LED (X2)	LED (X2)
V	White/Gray	29		Contact 1 (NC)	Contact 1 (NC)
W	White/Orange	30		Contact 1 (NC)	Contact 1 (NC)
X	White/Purple	31		Contact 2 (NC)	Contact 2 (NC)
Y	White/Pink	32	Contact 2 (NC)	Contact 2 (NC)	
Z	Red	33	Enabling switch	Contact 1 (COM)	Contact 1 (COM)
a	Green	34		Contact 1 (NO)	Contact 1 (NO)
b	Yellow	35		Contact 2 (COM)	Contact 2 (COM)
c	Brown	36		Contact 2 (NO)	Contact 2 (NO)

*1) Stranded wire core color for option cable HT9Z-4PC1*M.
*2) D-sub37p connector pin number for option cable HT9Z-4PC15MC
•Wiring not available for pin number 3, 4, 9, 10, 20, 22 to 26 and 37.

System configuration

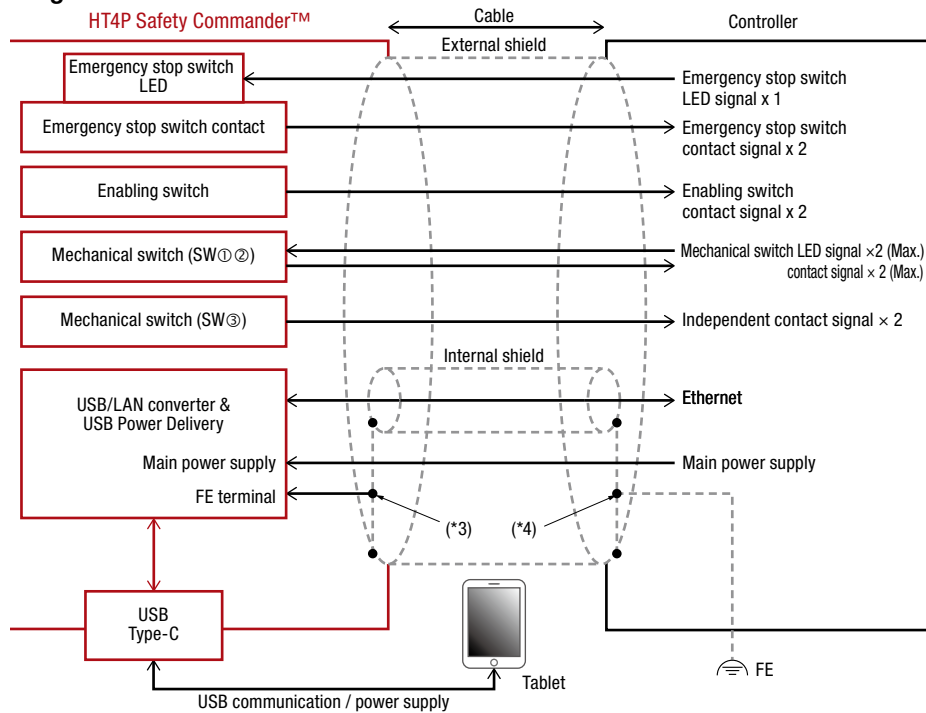

- 3) Connect both the internal shield and external shield to the FE terminal.
- 4) Connect both the internal shield and external shield to FE.

Safety Precautions ⚠

- Turn off the power to the product before starting installation, removal, wiring, maintenance, or inspection. Failure to turn power off may cause electrical shock or fire.

Instructions

Be sure to read the instruction manual carefully before performing installation, wiring, or maintenance work.

For details on mounting, wiring, and maintenance, see the instruction manual from the below URL.

URL: <https://product.idec.com/?product=HT4P>
<https://product.idec.com/?product=HT4P-LB>



HT4P



HT4P mechanical switch mount model

HT3P

Lightweight, basic type

8 to 11 inches

(Patent pending)



Fits 8- to 11-inch tablets

The adjustable docking structure fits screen sizes of 8 to 11 inches. Safety Commander™ can also be attached to tablets with thicknesses of up to 24mm (*1) by using a spacer accessory. Thick and robust tablets can also be mounted.

*1) Standard thickness: up to 10mm. When accessory "tablet thickness adjustment kit A" is used: up to 18mm. When accessory "tablet thickness adjustment kit B" is used: up to 24mm



Screen size: 8 to 11 inches Thickness: up to 24mm

Emergency stop pushbutton switch with LED indicator

Equipped with a safety lock mechanism, safe break action structure, and direct opening action.

Rotating holder

Ease of holding and operability. Adapts to both vertical and horizontal use.



Horizontal right-hand use Vertical left-hand use Horizontal left-hand use

Three-position enabling switch

Safety during work operations is assured by the ergonomically designed three-position action to avoid danger.

Note: ISO 10218 series specifies the requirement for the installation of the three-position enabling switch on the teaching pendant.

USB charging port

No need to worry about the battering running out while communicating.

Note: 5V DC-1.5A output

Wall mount

Wall mount bracket (accessory) enables operation while fixed to the wall

Note: Only for operations that do not require an enabling switch.



5m cable supplied (with nylon connector terminal)

Expansion lock

Prevents unintentional removal of the tablet.

Expansion lock lever

Locks the tablet holder from extending.

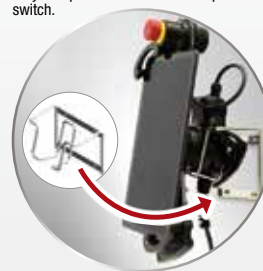

Product

Package Quantity: 1

Item	Part No.
HT3P Safety Commander™	HT3P-SLNP-5M

Specification

Item	Specification	
Structure	Degree of Protection	IP54
	Compatible tablet size	8 to 11 inch
Switch	Emergency stop switch	XA1E-LV302Q4R (IDEC)
	Enabling switch	HE5B-M2PY (IDEC)
Power	USB power supply	USB port: Type-C
		7.5w
External cable connection method	5m cable supplied	

System configuration

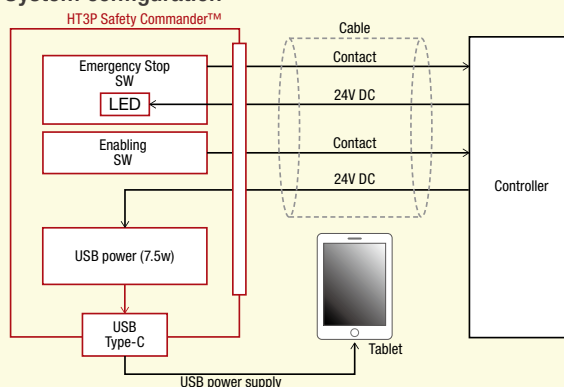

Ordering Terms and Conditions

Thank you for using IDEC Products.

By purchasing products listed in our catalogs, datasheets, and the like (hereinafter referred to as "Catalogs") you agree to be bound by these terms and conditions. Please read and agree to the terms and conditions before placing your order.

1. Notes on contents of Catalogs

- (1) Rated values, performance values, and specification values of IDEC products listed in this Catalog are values acquired under respective conditions in independent testing, and do not guarantee values gained in combined conditions.
Also, durability varies depending on the usage environment and usage conditions.
- (2) Reference data and reference values listed in Catalogs are for reference purposes only, and do not guarantee that the product will always operate appropriately in that range.
- (3) The specifications / appearance and accessories of IDEC products listed in Catalogs are subject to change or termination of sales without notice, for improvement or other reasons.
- (4) The content of Catalogs is subject to change without notice.

2. Note on applications

- (1) If using IDEC products in combination with other products, confirm the applicable laws / regulations and standards.
Also, confirm that IDEC products are compatible with your systems, machines, devices, and the like by using under the actual conditions. IDEC shall bear no liability whatsoever regarding the compatibility with IDEC products.
- (2) The usage examples and application examples listed in Catalogs are for reference purposes only. Therefore, when introducing a product, confirm the performance and safety of the instruments, devices, and the like before use. Furthermore, regarding these examples, IDEC does not grant license to use IDEC products to you, and IDEC offers no warranties regarding the ownership of intellectual property rights or non-infringement upon the intellectual property rights of third parties.
- (3) When using IDEC products, be cautious when implementing the following.
 - i. Use of IDEC products with sufficient allowance for rating and performance
 - ii. Safety design, including redundant design and malfunction prevention design that prevents other danger and damage even in the event that an IDEC product fails
 - iii. Wiring and installation that ensures the IDEC product used in your system, machine, device, or the like can perform and function according to its specifications
- (4) Continuing to use an IDEC product even after the performance has deteriorated can result in abnormal heat, smoke, fires, and the like due to insulation deterioration or the like. Perform periodic maintenance for IDEC products and the systems, machines, devices, and the like in which they are used.
- (5) IDEC products are developed and manufactured as general-purpose products for general industrial products. They are not intended for use in the following applications, and in the event that you use an IDEC product for these applications, unless otherwise agreed upon between you and IDEC, IDEC shall provide no guarantees whatsoever regarding IDEC products.
 - i. Use in applications that require a high degree of safety, including nuclear power control equipment, transportation equipment (railroads / airplanes / ships / vehicles / vehicle instruments, etc.), equipment for use in outer space, elevating equipment, medical instruments, safety devices, or any other equipment, instruments, or the like that could endanger life or human health
 - ii. Use in applications that require a high degree of reliability, such as provision systems for gas / waterworks / electricity, etc., systems that operate continuously for 24 hours, and settlement systems
 - iii. Use in applications where the product may be handled or used deviating from the specifications or conditions / environment listed in the Catalogs, such as equipment used outdoors or applications in environments subject to chemical pollution or electromagnetic interference
If you would like to use IDEC products in the above applications, be sure to consult with an IDEC sales representative.

3. Inspections

We ask that you implement inspections for IDEC products you purchase without delay, as well as thoroughly keep in mind management/maintenance regarding handling of the product before and during the inspection.

4. Warranty

(1) Warranty period

The warranty period for IDEC products shall be one (1) year after purchase or delivery to the specified location. However, this shall not apply in cases where there is a different specification in the Catalogs or there is another agreement in place between you and IDEC.

(2) Warranty scope

Should a failure occur in an IDEC product during the above warranty period for reasons attributable to IDEC, then IDEC shall replace or repair that product, free of charge, at the purchase location / delivery location of the product, or an IDEC service base. However, failures caused by the following reasons shall be deemed outside the scope of this warranty.

- i. The product was handled or used deviating from the conditions / environment listed in the Catalogs
 - ii. The failure was caused by reasons other than an IDEC product
 - iii. Modification or repair was performed by a party other than IDEC
 - iv. The failure was caused by a software program of a party other than IDEC
 - v. The product was used outside of its original purpose
 - vi. Replacement of maintenance parts, installation of accessories, or the like was not performed properly in accordance with the user's manual and Catalogs
 - vii. The failure could not have been predicted with the scientific and technical standards at the time when the product was shipped from IDEC
 - viii. The failure was due to other causes not attributable to IDEC (including cases of force majeure such as natural disasters and other disasters)
- Furthermore, the warranty described here refers to a warranty on the IDEC product as a unit, and damages induced by the failure of an IDEC product are excluded from this warranty.

5. Limitation of liability

The warranty listed in this Agreement is the full and complete warranty for IDEC products, and IDEC shall bear no liability whatsoever regarding special damages, indirect damages, incidental damages, or passive damages that occurred due to an IDEC product.

6. Service scope

The prices of IDEC products do not include the cost of services, such as dispatching technicians. Therefore, separate fees are required in the following cases.

- (1) Instructions for installation / adjustment and accompaniment at test operation (including creating application software and testing operation, etc.)
- (2) Maintenance inspections, adjustments, and repairs
- (3) Technical instructions and technical training
- (4) Product tests or inspections specified by you

The above content assumes transactions and usage within your region. Please consult with an IDEC sales representative regarding transactions and usage outside of your region. Also, IDEC provides no guarantees whatsoever regarding IDEC products sold outside your region.

IDEC CORPORATION

Head Office 6-64, Nishi-Miyahara-2-Chome, Yodogawa-ku, Osaka 532-0004, Japan

USA IDEC Corporation
EMEA APEM SAS

Singapore IDEC Izumi Asia Pte. Ltd.
Thailand IDEC Asia (Thailand) Co., Ltd.
India IDEC Controls India Private Ltd.

China IDEC (Shanghai) Corporation
IDEC Izumi (H.K.) Co., Ltd.
Taiwan IDEC Taiwan Corporation

Japan IDEC Corporation

 www.idec.com

Specifications and other descriptions in this brochure are subject to change without notice. Information in this brochure is current as of December, 2023.

2023 IDEC Corporation, All Rights Reserved.

EP1791-4

