

FT1A Series



Smart **AXIS**

SmartAXIS Touch User's Manual

Confirm that the delivered product is what you have ordered. Read this manual to make sure of correct operation.

SAFETY PRECAUTIONS

- Be certain to read this manual carefully before performing installation, wiring, or maintenance work, or operating the SmartAXIS FT1A-*12RA-*, FT1A-*14KA-* and FT1A-*14SA-*.
- The SmartAXIS FT1A-*12RA-*, FT1A-*14KA-* and FT1A-*14SA-* has been manufactured with careful regard to quality. However, if you intend to use this product in applications where failure of this equipment may result in damage to property or injury, ensure that it used in conjunction with appropriate fail-safe backup equipment.
- In this manual, safety precautions are categorized in order of importance to Warning and Caution:

 WARNING	Warning notices are used to emphasize that improper operation may cause severe personal injury or death.
 CAUTION	Caution notices are used where inattention might cause personal injury or damage to equipment.

WARNING

- When using the SmartAXIS FT1A-*12RA-*, FT1A-*14KA-*, and FT1A-*14SA-* in applications that require a high degree of safety such as nuclear equipment, railways, aircraft, medical equipment, and vehicles, give consideration to measures such as the addition of fail-safes and backup functions. In addition, we ask that you contact your IDEC sales office to confirm the safety of the application according to the specifications and similar documents.
- Turn off the power to the SmartAXIS FT1A-*12RA-*, FT1A-*14KA-* and FT1A-*14SA-* before installation, removal, wiring, maintenance, and inspection of the SmartAXIS FT1A-*12RA-*, FT1A-*14KA-* and FT1A-*14SA-*. Failure to turn power off may cause electrical shock or fire hazard.
- Special expertise is required to install, wire, configure, and operate the SmartAXIS FT1A-*12RA-*, FT1A-*14KA-* and FT1A-*14SA-*. People without such expertise must not use the SmartAXIS FT1A-*12RA-*, FT1A-*14KA-* and FT1A-*14SA-*.
- The SmartAXIS FT1A-*12RA-*, FT1A-*14KA-* and FT1A-*14SA-* uses an LCD (liquid crystal display) as a display device. The liquid inside the LCD is harmful to the skin. If the LCD is broken and the liquid attaches to your skin or clothes, wash the liquid off using soap, and consult a doctor immediately.
- Emergency and interlocking circuits must be configured outside of the SmartAXIS FT1A-*12RA-*, FT1A-*14KA-* and FT1A-*14SA-*.
- If relays in the SmartAXIS FT1A-*12RA-*, FT1A-*14KA-* and FT1A-*14SA-* output circuits should fail, outputs may remain at on or off state. For output signals which may cause serious accidents, configure monitor circuits outside the SmartAXIS FT1A-*12RA-*, FT1A-*14KA-* and FT1A-*14SA-*.
- The SmartAXIS FT1A-*12RA-*, FT1A-*14KA-* and FT1A-*14SA-* self-diagnostic function may detect internal circuit or program errors, stop programs, and turn outputs off. Configure circuits so that the system containing the SmartAXIS FT1A-*12RA-*, FT1A-*14KA-* and FT1A-*14SA-* are not jeopardized when outputs turn off.
- Do not use the SmartAXIS FT1A-*12RA-*, FT1A-*14KA-* and FT1A-*14SA-*'s internal touch switches for an emergency circuit. If the SmartAXIS FT1A-*12RA-*, FT1A-*14KA-* and FT1A-*14SA-* failed, the external equipment connected to the SmartAXIS FT1A-*12RA-*, FT1A-*14KA-* and FT1A-*14SA-* will no longer be protected, and serious injury to operators and equipment damage may be caused.

CAUTION

- Prevent the SmartAXIS FT1A-*12RA-*, FT1A-*14KA-* and FT1A-*14SA-* from falling while moving or transporting, otherwise damage or malfunction of the SmartAXIS FT1A-*12RA-*, FT1A-*14KA-* and FT1A-*14SA-* will result.
- Use the product within the environmental limits given in the catalog and manual. Use of the product in high-temperature or high-humidity environments, or in locations where it is exposed to condensation, corrosive gas or large shock loads can create the risk of electrocution and fire.
- The SmartAXIS FT1A-*12RA-*, FT1A-*14KA-* and FT1A-*14SA-* are designed for use in pollution degree 2. Use the SmartAXIS FT1A-*12RA-*, FT1A-*14KA-* and FT1A-*14SA-* in environments of pollution degree 2. (based on the IEC60664-1 rating)
- Install the SmartAXIS FT1A-*12RA-*, FT1A-*14KA-* and FT1A-*14SA-* according to the instructions. Improper installation will result in falling, failure, electrical shock, fire hazard, or malfunction of the SmartAXIS FT1A-*12RA-*, FT1A-*14KA-* and FT1A-*14SA-*.
- Prevent metal fragments or wire chips from dropping inside the SmartAXIS FT1A-*12RA-*, FT1A-*14KA-* and FT1A-*14SA-* housing. Ingress of such fragments and chips may cause fire hazard, damage, and malfunction.
- Use a power supply of the rated value. Using a wrong power supply may cause fire hazard.
- The SmartAXIS FT1A-*12RA-*, FT1A-*14KA-* and FT1A-*14SA-* uses "PS2 of EN61131" as DC power supply. (based on the IEC/EN61131 rating)
- Use wire of a proper size to meet the voltage and current requirements.
- Use an IEC 60127-approved fuse on the output circuit and the power line outside the FT1A-*12RA-*, FT1A-*14KA-* and FT1A-*14SA-*. This is required when equipment containing the SmartAXIS FT1A-*12RA-*, FT1A-*14KA-* and FT1A-*14SA-* is destined for Europe.
- Use an EU-approved circuit breaker. This is required when equipment containing the SmartAXIS FT1A-*12RA-*, FT1A-*14KA-* and FT1A-*14SA-* is destined for Europe.
- Make sure of safety before starting and stopping the SmartAXIS FT1A-*12RA-*, FT1A-*14KA-* and FT1A-*14SA-*. Incorrect operation of the SmartAXIS FT1A-*12RA-*, FT1A-*14KA-* and FT1A-*14SA-* may cause mechanical damage or accidents.
- Use the SmartAXIS FT1A-*12RA-*, FT1A-*14KA-* and FT1A-*14SA-* in a local area network if you download or upload the project data via the Ethernet port.
- The touch panel of the SmartAXIS FT1A-*12RA-*, FT1A-*14KA-* and FT1A-*14SA-* is made of glass, and will break if exposed to excessive shock. Take due care when handling it.
- When more than one button is pressed at the same time, due to the detection characteristics of an analog type touch panel, only the gravity center of the pressed area is sensed and the unit assumes that only one button is pressed. Thus, when more than one button is pressed simultaneously, the resulting operation is not guaranteed.
- The screen becomes blank when the backlight is burnt out; however, the touch panel remains enabled. Incorrect touch panel operation will occur when operating the touch panel when the backlight appears to be turned off but is actually burnt out. Note that this erroneous operation may result in damage.
- Do not push hard or scratch the touch panel and protection sheet with a hard object such as a tool, because they are damaged easily.
- At temperatures over the rated operating temperature, the clock accuracy is affected. Adjust the clock before use.
- For applications which require clock accuracy, adjust the clock periodically.
- Do not install the SmartAXIS FT1A-*12RA-*, FT1A-*14KA-* and FT1A-*14SA-* in areas subjected to strong ultraviolet rays, since ultraviolet rays may impair the quality of the LCD.
- Do not attempt to disassemble, repair or modify the SmartAXIS FT1A-*12RA-*, FT1A-*14KA-* and FT1A-*14SA-*. This can create the risk of fire or electrocution.
- When disposing of the SmartAXIS FT1A-*12RA-*, FT1A-*14KA-* and FT1A-*14SA-*, do so as an industrial waste.
- Do not switch off the power or pull out the USB flash drive while it is being accessed, as this may result in destruction of the stored data. If the data on the USB flash drive is corrupted, format the USB flash drive.

Handling of Batteries and Devices with Built-in Batteries in EU Member States

Note) The following symbol mark only applies to EU countries.

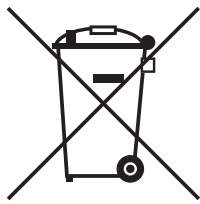

This symbol mark means that batteries and accumulators, at their end-of life, should be disposed of separately from your household waste.

If a chemical symbol is printed beneath the symbol shown above, this chemical symbol means that the battery or accumulator contains a heavy metal at a certain concentration. This will be indicated as follows :

Hg : mercury (0.0005%), Cd : cadmium (0.002%), Pb : lead (0.004%)

In the European Union there are separate collection systems for used batteries and accumulators. Please dispose of batteries and accumulators correctly in accordance with each country or local regulation.

Revision history

March 2013:	First Edition
August 2013:	Second Edition
June 2014:	Third Edition
February 2015:	Fourth Edition
March 2016:	Fifth Edition
January 2017:	Sixth Edition
May 2019:	Seventh Edition
December 2019:	Eighth Edition

Caution

- The contents of this manual and the WindO/I-NV3 and WindLDR applications are copyright, and all rights are reserved by IDEC Corporation. Unauthorized duplication, reproduction, sales, transfers, or leasing is prohibited.
- The contents of this manual and the WindO/I-NV3 and WindLDR applications are subject to change without notice.
- IDEC Corporation accepts no responsibility for circumstances arising from the use of this manual or the WindO/I-NV3 and WindLDR applications.
- Please contact your vendor or IDEC Corporation with any problems regarding the operation of this product.

Trademarks

WindO/I, WindLDR, WindCFG, SmartAXIS and MICRO/I are registered trademarks of IDEC CORPORATION in JAPAN. Microsoft and Windows are trademarks of the Microsoft Corporation of the United States, other countries, or both. Adobe is a trademark of Adobe Systems Incorporated.

All other company names and product names used in this manual or the WindO/I-NV3 application are trademarks of their respective owners.

Regarding laws and compatible standards

This product adheres to the laws and compatible standards of all countries involved as shown below.

European laws and standards

This product complies with the following EU directives.

- Low Voltage Directive
- EMC Directive

To comply with these directives, this product has been designed and evaluated on the basis of the following international and European standard.

- IEC/EN 61131-2: 2007 (excluding the Lite digital I/O status indicators)

North American regulations/standards

This product has obtained the following certification from UL.

- UL508
- CSA C22.2 No.142
- ANSI/ISA 12.12.01
- CAN/CSA C22.2 No.213

Marine Standard

This product complies with the following the Marine Standard. (FT1A Version V120 or later)

- ABS (American Bureau of Shipping)
- DNV (Det Norske Veritas)
- LR (Lloyd's Register)
- NK (Nippon Kaiji Kyokai)

(Touch is not allowed to be installed on open decks.)

When using the Touch as the Marine Standard Approved Products, attach a ferrite core (ZCAT3035-1330 manufactured by TDK Corporation) to the power cables (2 turns), the cable for each communication port (2 turns). And attach a ferrite core (ZCAT3035-1330 manufactured by TDK Corporation) to the cable for communication cartridge (2turns).

For details on the compatible standards and EU Directives, contact the distributor from which you purchased this product or visit our web site.

Preface

This user's manual describes entire functions, specifications, installation, and operation basics of the SmartAXIS. Also included are powerful communications of the SmartAXIS and troubleshooting procedures.

This manual describes SmartAXIS Touch (SmartAXIS FT1A-*12RA-*, FT1A-*14KA-* and FT1A-*14SA-*) and WindO/I-NV3 software. The information includes drawing tools, setup procedures, and how to configure all Touch operator interfaces.

This user's manual describes the operation and handling of the SmartAXIS FT1A-*12RA-*, FT1A-*14KA-* and FT1A-*14SA-*. Please read it carefully and ensure that you fully understand the functions and performance of the SmartAXIS FT1A-*12RA-*, FT1A-*14KA-* and FT1A-*14SA-* and the WindO/I-NV3 software.

Read the following materials as necessary for your particular application.

Type No.	References	Content
FT9Y-B1390	SmartAXIS Touch User's Manual (This document)	Describes the hardware specifications of the SmartAXIS FT1A-*12RA-*, FT1A-*14KA-* and FT1A-*14SA-*.
FT9Y-B1382	SmartAXIS Ladder Programming Manual	Describes basic operations for ladder programming, instructions for monitoring on the SmartAXIS, available devices and instruction lists, and details of each instruction.
FT9Y-B1386	SmartAXIS FBD Programming Manual	Describes basic operations for function block programming, available devices and function block lists, and details of each function block.
External Device Setup Manual		Describes the connection procedures and available devices for various communication including the PLC-Link communication, O/I Link communication, and DM Link communication.
WindO/I-NV3 Help		Describes programming for the SmartAXIS Touch series, and usage instructions for the WindO/I-NV3 software.
WindLDR Help		Describes usage instructions for WindLDR, programming software for the SmartAXIS Pro/Lite series.
Character Table (PDF)		A list of fonts can be used with the SmartAXIS FT1A-*12RA-*, FT1A-*14KA-* and FT1A-*14SA-* and WindO/I-NV3. For restrictions on using the SmartAXIS FT1A-*12RA-*, FT1A-*14KA-* and FT1A-*14SA-*, refer to Chapter 2 "1.2 Available Text" on page 2-5.

This manual describes the FT1A Series SmartAXIS Touch and the WindO/I-NV3 software.

Unless otherwise specified, SmartAXIS refers to the FT1A Series SmartAXIS Touch.

For the FT1A Series SmartAXIS Pro and the FT1A Series SmartAXIS Lite, refer to the "SmartAXIS Pro/Lite User's Manual".

Symbols Used in this Document

This manual uses the following symbols to facilitate description.

Symbols



..... Useful information relating to a function



..... Information that requires special attention. Failure to operate the product in accordance with the information provided can lead to serious injury or damage.



..... Indicates the chapter/page of related reference information.

OK

..... Screen buttons are indicated by **bold** text or by using the actual graphic icon.

SHIFT, 

..... Keyboard keys are indicated by the keyboard inscription in capital letters or enclosed in square brackets.

..... Controls are indicated by **bold** text.

Abbreviations, Generic Terms, and Terminology Used in this Manual

Item	Description
SmartAXIS	Another name for the SmartAXIS FT1A Series.
Touch	The generic term for the SmartAXIS FT1A-*12RA-*, FT1A-*14KA-* and FT1A-*14SA-*.
Touch (relay output type)	The generic term for the SmartAXIS FT1A-*12RA-*.
Touch (transistor output type)	The generic term for the SmartAXIS FT1A-*14KA-* and the FT1A-*14SA-*.
Pro	The generic term for the FT1A Series that includes an LCD, excluding the Touch.
Lite	The generic term for the FT1A Series that does not include an LCD, excluding the Touch.
MICRO/I	Generic term used to refer to the O/I Touchscreen HG2G-S/-5S/-5F, HG3G/4G, HG1F/2F/2S/3F/4F.
External device	Generic term used to refer to a PLC or micro computer that is connected to and communicates with the Touch.
FBD	The abbreviation for "function block diagram".
FB	Function block For example, the AND (logical AND) function block is written as AND FB.
Device Address	Memory that is capable of storing values in unit of bits or words loaded on the Touch and external device.
System Area	Device area that is pre-allocated for exchanging screen management, error information, and clock data between the Touch and external device.
PLC Link Communication	A communication method that performs communication with the external device according to the setting of the screen and without a program.
DM Link Communication	A communication method that reads to or writes from the Touch device from a computer or microcomputer board.
User Communication	A communication method which performs communication with external devices such as barcode readers and inverters.
No External Devices	A method that is capable of operating the Touch independently without connecting to external device.
O/I Link	A connection format that enables connections of up to 16 units of Touch with high-speed communication of 115,200bps.
O/I Link Master	The Touch unit that is directly connected to external device on the O/I Link network.
O/I Link Slave	The Touch units that are not directly connected to external device on the O/I Link network.
WindO/I-NV3	Software for creating projects and data of the Touch.
WindLDR	This is the editor for the control functions of the Touch. It is launched from WindO/I-NV3. Operations for creating ladder program or FBD Program are similar to those of the WindLDR PLC programming software for the Pro and Lite.
WindCFG	This system configuration tool intuitively implements optimized settings for devices and system configurations through a combination of PLCs, operator interfaces, and other peripheral equipment by selecting icons and dragging and dropping them.
Project	Data including image data required for operating the Touch, which is created with WindO/I-NV3 software.
Manager	WindO/I-NV3 provides tools to manage pictures, text and script etc. With the Managers, you can create and manage them in your project.
Setup	Generic term used to refer to the common settings in the project.
Project Settings	Basic settings of operation in the Setup settings.
Alarm Log	A function where the Touch collects log data of alarms.
Data Log	A function where the Touch collects data of device addresses.
Script	A script is an executable list of commands created by a simple programming language.
Control function	The control function by ladder program or FBD program created with WindLDR.
Text Group	A group of 16 texts maximum that is in order to dynamically switch the character displayed on the Touch according to the value of device.
Windows Font	Text fonts that can be displayed on the Windows OS on which the WindO/I-NV3 is running.
Maintenance Communication	Communications between the WindO/I-NV3 and Touch using a dedicated protocol.
Device Monitor	A special Popup Screen on the Touch on which value of device can be displayed or changed.
System Screen	Pre-allocated screen dedicated for performing initial setting of the Touch, self-diagnosis, and clearing the log data etc.

Item	Description
External memory	For the Touch, a USB flash drive.
Window	Screens that are loaded on to the Base Screen, including Popup Screen and Device Monitor.
Drawings	Define as as non functional content (i.e. shape, picture, text).
Parts	Define as functional content (i.e. button, pilot lamp, commands, etc.)
Object	Define as combination of Drawings and Parts placed on WindO/I-NV3 edit screen.
Touch Switch	A part that operates a function by pressing parts that have been placed on the screen.
Standard Keypad	Keypad that is displayed when operating Numerical and Character Input parts when Standard is selected under Type in the Keypad menu for Numerical and Character Input parts.
Keep Device	Generic term for internal devices that are not reset when operation is started. Even after the power is turned off, the values are retained by the battery.

Contents

SAFETY PRECAUTIONS	Preface-1
Revision history	Preface-3
Caution	Preface-3
Trademarks.....	Preface-3
Regarding laws and compatible standards	Preface-3
Preface	Preface-5
Symbols Used in this Document.....	Preface-6
Abbreviations, Generic Terms, and Terminology Used in this Manual	Preface-7

Chapter 1 General Information for SmartAXIS

1	About the SmartAXIS	1-1
	1.1 Type Numbers.....	1-1
	1.2 Features for the Touch.....	1-2
	1.3 Special Functions for the Touch	1-3
2	About the WindO/I-NV3	1-5
3	Operating Modes	1-6
4	Flow from Screen and Ladder Program or FBD Program Creation to Run Operation	1-7

Chapter 2 WindO/I-NV3 Basic Operations

1	WindO/I-NV3 Specifications.....	2-1
	1.1 Available Data	2-1
	1.2 Available Text.....	2-5
	1.3 Available Number of Colors	2-18
	1.4 Available Image Files	2-18
2	Starting and Exiting WindO/I-NV3	2-33
	2.1 Starting WindO/I-NV3.....	2-33
	2.2 Exiting WindO/I-NV3	2-35
3	Configuration & Functions	2-36
	3.1 Application Menu Command List	2-37
	3.2 Quick Access Toolbar	2-38
	3.3 Ribbon Command List.....	2-41
	3.4 Windows Displayed in the Workspace	2-49
	3.5 Status Bar.....	2-53
4	Customizing WindO/I-NV3.....	2-56
	4.1 Configuring the Work Environment	2-56
	4.2 Customizing the Workspace	2-59
5	WindO/I-NV3 Common Operations and Settings.....	2-61
	5.1 Device Address Settings.....	2-61
	5.2 Setting Conditional Expressions	2-63

Chapter 3 Project

1	Creating WindO/I-NV3 Project Data	3-1
	1.1 Creating New Project Data	3-1
	1.2 Opening Project Data	3-4
	1.3 Saving Project Data	3-5
	1.4 Printing Project Data	3-7
	1.5 Comparing Project Data	3-13
	1.6 Changing Project Settings	3-14
	1.7 Closing Project Data	3-17
2	Project Settings Configuration Procedure	3-18
3	Project Settings Dialog Box	3-19
	3.1 System Tab	3-19
	3.2 Communication Interface Tab	3-27
	3.3 Communication Driver Tab	3-32
	3.4 Communication Driver Network Tab	3-34
	3.5 Communication Driver Extension Tab	3-36
	3.6 O/I Link Tab	3-37
	3.7 User Communication Tab	3-38
	3.8 External Memory Tab	3-40
	3.9 Autorun Tab	3-41
	3.10 Project Details Tab	3-42
	3.11 Contents Tab	3-44
4	Special Functions	3-45
	4.1 Function Area Settings Configuration Procedure	3-46
	4.2 Stop Input	3-48
	4.3 Reset Input	3-49
	4.4 Run/Stop Selection at Memory Backup Error	3-51
	4.5 Run/Stop Selection at Power Up	3-52
	4.6 Keep and Clear Control Devices	3-53
	4.7 High-Speed Counter	3-55
	4.8 Catch Input	3-72
	4.9 Interrupt Input	3-74
	4.10 Frequency Measurement	3-77
	4.11 Input Filter	3-79
	4.12 Analog Input	3-81
	4.13 Timer Interrupt	3-84
	4.14 Analog Output	3-86
	4.15 Analog Cartridge	3-88
	4.16 Ladder Monitor	3-97
	4.17 Watchdog Timer Setting	3-98
	4.18 Daylight Savings Time	3-100
	4.19 Clock Function	3-101
	4.20 Connection Settings	3-104
	4.21 Remote Host List	3-106
5	Project Restrictions	3-108
	5.1 Download Restrictions	3-108
	5.2 Maximum Number of External Devices	3-108

Chapter 4 Screen

1	Screen Overview	4-1
	1.1 Screen Types	4-1
	1.2 Screen Size	4-1
2	Creating and Manipulating WindO/I-NV3 Screens	4-2
	2.1 Creating Screens	4-2
	2.2 Opening Screens	4-2
	2.3 Saving Screens	4-4
	2.4 Closing Screens	4-6
	2.5 Duplicating Screens	4-8
	2.6 Deleting Screens	4-10
	2.7 Reusing Screens	4-12
3	Base Screen	4-14
	3.1 Base Screen Settings	4-14
	3.2 Displaying Layered Base Screens	4-18
	3.3 Operating When Drawing Objects and Parts Overlap	4-20
4	Popup Screen	4-22
	4.1 Popup Screen Settings	4-22
	4.2 Popup Screen Configuration	4-25
	4.3 Standard Keypad Popup Screen	4-26
5	Screen Restrictions	4-27
	5.1 Screen Number Restrictions	4-27
	5.2 Maximum Number of Parts	4-27
	5.3 Maximum Number of External Device Address	4-28
	5.4 Vertical Installation Restrictions	4-28
6	Using Library Screens	4-29
	6.1 What You Can Do with Library Screens	4-29
	6.2 Creating a Library Screen	4-30
	6.3 Using a Library Screen	4-31
	6.4 Deleting Library Screens	4-33
	6.5 Exporting Library Screens	4-34
	6.6 Importing Library Screens	4-35

Chapter 5 Drawings and Parts

1	Overview	5-1
2	Drawing Objects	5-2
	2.1 Shapes	5-2
	2.2 Picture	5-2
	2.3 Text	5-2
3	Part Types	5-3
	3.1 Buttons	5-3
	3.2 Lamps	5-3
	3.3 Data Displays	5-3
	3.4 Charts	5-3
	3.5 Commands	5-4

Chapter 6 Drawings

1	Shapes.....	6-1
	1.1 Line	6-1
	1.2 Polyline	6-3
	1.3 Polygon	6-5
	1.4 Rectangle	6-7
	1.5 Circle/Ellipse	6-10
	1.6 Arc.....	6-13
	1.7 Pie	6-15
	1.8 Equilateral Polygons	6-18
	1.9 Fill	6-21
2	Picture	6-23
	2.1 Picture Configuration Procedure	6-23
	2.2 Properties of Picture Dialog Box	6-24
3	Text	6-25
	3.1 Text Configuration Procedure	6-25
	3.2 Properties of Text dialog box	6-26

Chapter 7 Buttons

1	Bit Button.....	7-1
	1.1 How the Bit Button is Used	7-1
	1.2 Bit Button Configuration Procedure.....	7-3
	1.3 Properties of Bit Button Dialog Box	7-4
2	Word Button.....	7-17
	2.1 How the Word Button is Used	7-17
	2.2 Word Button Configuration Procedure	7-20
	2.3 Properties of Word Button Dialog Box	7-21
3	Goto Screen Button.....	7-35
	3.1 How the Goto Screen Button is Used	7-35
	3.2 Goto Screen Button Configuration Procedure	7-36
	3.3 Properties of Goto Screen Button Dialog Box	7-37
4	Key Button	7-49
	4.1 How the Key Button is Used	7-49
	4.2 Key Button Configuration Procedure	7-50
	4.3 Properties of Key Button Dialog Box	7-51
	4.4 Key Buttons	7-63
	4.5 Key Browser	7-66
5	Multi-Button	7-68
	5.1 How the Multi-Button is Used	7-68
	5.2 Multi-Button Configuration Procedure	7-69
	5.3 Properties of Multi-Button Dialog Box.....	7-70
6	Keypad	7-90
	6.1 How the Keypad is Used	7-90
	6.2 Keypad Configuration Procedure.....	7-91
	6.3 Properties of Keypad Dialog Box.....	7-92
7	Selector Switch.....	7-94
	7.1 How the Selector Switch is Used	7-94
	7.2 Selector Switch Configuration Procedure	7-95
	7.3 Properties of Selector Switch Dialog Box	7-96
8	Potentiometer.....	7-109
	8.1 How the Potentiometer is Used	7-109

8.2	Potentiometer Configuration Procedure	7-110
8.3	Properties of Potentiometer Dialog Box	7-111

Chapter 8 Lamps

1	Pilot Lamps	8-1
1.1	How the Pilot Lamp is Used.....	8-1
1.2	Pilot Lamp Configuration Procedure	8-2
1.3	Properties of Pilot Lamp Dialog Box	8-3
2	Multi-State Lamps.....	8-14
2.1	How the Multi-State Lamp is Used	8-14
2.2	Multi-State Lamp Configuration Procedure.....	8-15
2.3	Properties of Multi-State Lamp Dialog Box.....	8-16

Chapter 9 Data Displays

1	Numerical Input	9-1
1.1	How the Numerical Input is Used	9-1
1.2	Numerical Input Configuration Procedure	9-2
1.3	Properties of Numerical Input Dialog Box	9-3
1.4	How to Enter Values	9-21
1.5	Advanced Usage.....	9-22
2	Character Input	9-23
2.1	How the Character Input is Used	9-23
2.2	Character Input Configuration Procedure.....	9-24
2.3	Properties of Character Input Dialog Box.....	9-25
2.4	How to Enter Text	9-37
2.5	String Data Storage Method	9-38
2.6	Advanced Usage.....	9-39
3	Picture Display	9-40
3.1	How the Picture Display is Used	9-40
3.2	Picture Display Configuration Procedure	9-42
3.3	Properties of Picture Display Dialog Box	9-43
4	Message Display	9-53
4.1	How the Message Display is Used	9-53
4.2	Message Display Configuration Procedure	9-55
4.3	Properties of Message Display Dialog Box.....	9-56
4.4	String Data Storage Method	9-69
5	Message Switching Display	9-70
5.1	How the Message Switching Display is Used.....	9-70
5.2	Message Switching Display Configuration Procedure.....	9-71
5.3	Properties of Message Switching Display Dialog Box.....	9-72
6	Alarm List Display	9-83
6.1	How the Alarm List Display is Used	9-83
6.2	Alarm List Display Configuration Procedure.....	9-84
6.3	Properties of Alarm List Display Dialog Box.....	9-85
7	Alarm Log Display.....	9-99
7.1	How the Alarm Log Display is Used.....	9-99
7.2	Alarm Log Display Configuration Procedure	9-100
7.3	Properties of Alarm Log Display Dialog Box	9-101
8	Numerical Display	9-114
8.1	How the Numerical Display is Used.....	9-114
8.2	Numerical Display Configuration Procedure	9-115

	8.3	Properties of Numerical Display Dialog Box	9-116
9	Calendar		9-129
	9.1	How the Calendar is Used	9-129
	9.2	Calendar Configuration Procedure	9-130
	9.3	Properties of Calendar Dialog Box.....	9-131

Chapter 10 Charts

1	Bar Chart		10-1
	1.1	How the Bar Chart is Used	10-1
	1.2	Bar Chart Configuration Procedure.....	10-2
	1.3	Properties of Bar Chart Dialog Box.....	10-3
2	Line Chart		10-19
	2.1	How the Line Chart is Used	10-19
	2.2	Line Chart Configuration Procedure	10-20
	2.3	Properties of Line Chart Dialog Box.....	10-21
3	Pie Chart		10-39
	3.1	How the Pie Chart is Used	10-39
	3.2	Pie Chart Configuration Procedure	10-40
	3.3	Properties of Pie Chart Dialog Box	10-41
4	Meter		10-48
	4.1	How the Meter is Used	10-48
	4.2	Meter Configuration Procedure	10-49
	4.3	Properties of Meter Dialog Box	10-50

Chapter 11 Commands

1	Bit Write Command.....		11-1
	1.1	How the Bit Write Command is Used	11-1
	1.2	Bit Write Command Configuration Procedure	11-3
	1.3	Properties of Bit Write Command Dialog Box	11-4
2	Word Write Command		11-9
	2.1	How the Word Write Command is Used.....	11-9
	2.2	Word Write Command Configuration Procedure	11-11
	2.3	Properties of Word Write Command Dialog Box	11-12
3	Goto Screen Command.....		11-18
	3.1	How the Goto Screen Command is Used	11-18
	3.2	Goto Screen Command Configuration Procedure.....	11-19
	3.3	Properties of Goto Screen Command Dialog Box.....	11-20
4	Script Command		11-25
	4.1	How the Script Command is Used.....	11-25
	4.2	Script Command Configuration Procedure	11-26
	4.3	Properties of Script Command Dialog Box	11-27
5	Multi-Command		11-31
	5.1	How the Multi-Command is Used.....	11-31
	5.2	Multi-Command Configuration Procedure	11-32
	5.3	Properties of Multi-Command Dialog Box	11-33
6	Timer		11-46
	6.1	How the Timer is Used	11-46
	6.2	Timer Configuration Procedure.....	11-47
	6.3	Properties of Timer Dialog Box	11-48

Chapter 12 Control Function

1	Control Function Actions	12-1
1.1	Actions and Operations of Ladder Program and FBD Program	12-1
2	Ladder Program.....	12-4
2.1	Basic Operation for WindLDR	12-4
2.2	Instructions Reference.....	12-14
3	FBD Program.....	12-32
3.1	Basic Operation for WindLDR	12-32
3.2	FB Reference	12-40
4	Remote I/O.....	12-46
4.1	Overview	12-46
4.2	Remote I/O Master.....	12-47

Chapter 13 Alarm Log Function

1	Overview	13-1
1.1	How the Alarm Log Function is Used.....	13-1
1.2	Alarm States	13-3
1.3	Sampling Data	13-4
1.4	Data Configuration	13-5
1.5	Saving and Deleting Data.....	13-7
1.6	Using Data and Detected Alarms	13-9
2	Alarm Log Function Configuration Procedure.....	13-10
2.1	Configuring the Devices to Monitor and the Alarm Detection Condition.....	13-10
3	Alarm Log Settings Dialog Box.....	13-13
3.1	Alarm Log Settings Dialog Box.....	13-13
4	Using Data and Detected Alarms.....	13-25
4.1	Displaying Saved Data with the Alarm Log Display.....	13-25
4.2	Displaying Registered Messages with the Alarm List Display According to the Active Alarm	13-27
4.3	Make a Sound of the Buzzer and Flash the Screen when an Alarm has Occurred	13-30
4.4	Saving Data as a CSV File	13-32

Chapter 14 Data Log Function

1	Overview	14-1
1.1	How the Data Log Function is Used	14-1
1.2	Sampling Values of Devices.....	14-3
1.3	Data Configuration	14-5
1.4	Saving and Deleting Data.....	14-6
1.5	Using the Data	14-7
2	Data Log Function Configuration Procedure	14-8
2.1	Configuring the Sampling Condition and Devices for Sampling Data	14-8
3	Data Log Settings Dialog Box.....	14-12
3.1	Data Log Settings Dialog Box	14-12
3.2	Individual Settings Dialog Box	14-14
4	Using the Data	14-25
4.1	Display the Data in the Line Chart	14-25
4.2	Displaying Data as Numerical Values.....	14-27
4.3	Saving Data as a CSV File	14-37

Chapter 15 Operation Log Function

1	Overview.....	15-1
	1.1 How the Operation Log Function is Used.....	15-1
	1.2 Recorded Events	15-3
	1.3 Data Configuration	15-4
	1.4 Saving and Deleting Data	15-6
	1.5 Using the Data.....	15-7
2	Operation Log Function Configuration Procedure	15-8
	2.1 Configuring the Events and the Condition for Recording.....	15-8
3	Operation Log Settings Dialog Box	15-10
	3.1 Operation Log Settings Dialog Box.....	15-10
4	Using the Data	15-17
	4.1 Saving the Data as a CSV File	15-17

Chapter 16 Data Storage Area

1	Overview.....	16-1
	1.1 What is the Data Storage Area?.....	16-1
	1.2 Data Storage Area.....	16-2
2	Data Storage Area Configuration Procedure	16-3
3	Data Storage Area Management Dialog Box	16-4
	3.1 Data Storage Area Management Dialog Box	16-4

Chapter 17 Preventive Maintenance Function

1	Overview.....	17-1
	1.1 How the Preventive Maintenance Function is Used.....	17-1
	1.2 Counting the Operation Time and Operation Count.....	17-2
	1.3 Thresholds.....	17-3
2	Preventive Maintenance Function Configuration Procedure	17-4
	2.1 Counting Operation Time and Operation Count.....	17-4
3	Preventive Maintenance Settings Dialog Box	17-6
	3.1 Preventive Maintenance Settings Dialog Box.....	17-6
	3.2 Individual Settings Dialog Box	17-8
4	Using the Data	17-11
	4.1 Displaying the Counted Operation Count on a Numerical Display	17-11
	4.2 Notifying with a Beep when the Counted Operation Time Reaches the Threshold	17-14

Chapter 18 Recipe Function

1	Overview.....	18-1
	1.1 How the Recipe Function is Used.....	18-1
	1.2 Data for Recipes	18-2
	1.3 Data Configuration	18-3
2	Recipe Function Configuration Procedure	18-4
	2.1 Configuring Recipe Function Operations and Devices	18-4
3	Recipe Settings Dialog Box	18-8
	3.1 Recipe Settings Dialog Box.....	18-8
	3.2 Individual Settings Dialog Box	18-10
4	Creating and Deleting Data for Recipes.....	18-14

4.1	Editing Recipe Data	18-14
4.2	Creating Recipe Files	18-17
4.3	Editing Recipe Files.....	18-21
4.4	Deleting Recipe Files	18-22

Chapter 19 Text Group

1	Overview	19-1
	1.1 How the Text Group Function is Used	19-1
	1.2 Functions that Support Text Groups	19-2
2	Text Groups and Text Configuration Procedure.....	19-3
	2.1 Creating Text Groups.....	19-3
	2.2 Registering Text	19-5
	2.3 Switching the Displayed Language by Value of Device.....	19-10
3	Text Manager	19-12
	3.1 Text Manager	19-12
	3.2 Text Group Settings Dialog Box	19-15

Chapter 20 Script

1	About the Script Function.....	20-1
	1.1 Overview of the Script Function.....	20-1
	1.2 Types and Trigger Conditions of the Script for HMI Function	20-2
	1.3 Data Type of the Script	20-3
	1.4 Script Error of HMI Function.....	20-4
2	Editing and Management of the Script.....	20-5
	2.1 Script Registration Procedure	20-5
	2.2 Script Manager.....	20-7
	2.3 Script Editor.....	20-8
3	Global Script	20-12
	3.1 Setting procedures for Global Script.....	20-12
4	Script Definition Method.....	20-14
	4.1 Format List	20-14
5	Script Coding Examples.....	20-22
	5.1 Control Statements.....	20-22
	5.2 Relational Operators.....	20-28
	5.3 Logical Operators	20-30
	5.4 Arithmetic Operators	20-31
	5.5 Bitwise Operators.....	20-32
	5.6 Bit Functions.....	20-34
	5.7 Word Functions	20-35
6	Important Notes.....	20-51
	6.1 Important Notes Regarding the While Definition	20-51
	6.2 Number of Devices That Can Be Used.....	20-51
	6.3 Write Delay.....	20-52
	6.4 About the Priority of the Operator.....	20-53

Chapter 21 User Accounts and the Security Function

1	Overview.....	21-1
	1.1 User Accounts.....	21-1
	1.2 Protecting Data.....	21-2
	1.3 Protecting Displays and Operations.....	21-5
2	Security Function Configuration Procedure.....	21-8
	2.1 Creating and Editing User Accounts.....	21-8
	2.2 Adding and Editing Security Groups.....	21-15
	2.3 Protecting the Display and Operation of Screens and Parts.....	21-18
3	User Accounts Dialog Box.....	21-30
	3.1 User Accounts Dialog Box.....	21-30
4	Password Input.....	21-36
	4.1 Entering the Password on the Touch.....	21-36
	4.2 Entering the Password in WindO/I-NV3.....	21-38

Chapter 22 Communication

1	PLC Link Communication.....	22-1
	1.1 Overview.....	22-1
	1.2 PLC Link Communication Settings.....	22-2
2	O/I Link Communication.....	22-3
	2.1 Overview.....	22-3
	2.2 O/I Link Communication Settings.....	22-3
3	DM Link Communication.....	22-4
	3.1 Overview.....	22-4
	3.2 DM Link Communication Settings.....	22-5
4	No External Devices.....	22-6
	4.1 Overview.....	22-6
	4.2 No External devices Settings.....	22-6
5	User Communication.....	22-7
	5.1 Overview.....	22-7
	5.2 User Communication Settings Procedure.....	22-8
	5.3 Protocol Manager.....	22-21
	5.4 Example of User Communication Settings.....	22-68
	5.5 Compatible USB Bar Code Readers.....	22-73
	5.6 Connection Diagram for User Communication.....	22-73

Chapter 23 Online Function

1	Communicating with the Touch.....	23-1
	1.1 How the Online Function is Used.....	23-1
	1.2 Connect Touch to a Computer.....	23-4
	1.3 Change Communication Settings.....	23-5
2	Downloading.....	23-11
	2.1 Downloading Project Data to the Touch.....	23-11
	2.2 Download Dialog Box.....	23-13
	2.3 Downloading Files to an External Memory Inserted in the Touch.....	23-16
3	Uploading.....	23-18
	3.1 Upload Project Data from the Touch.....	23-18
	3.2 Upload Dialog Box.....	23-21
4	Clear.....	23-22
	4.1 Clear Data from the Touch.....	23-22

	4.2	Deleting Data from an External Memory Inserted in the Touch.....	23-24
5		Formatting	23-26
	5.1	Formatting an External Memory Inserted in the Touch.....	23-26
6		System Information	23-27
	6.1	Displaying System Information	23-27
	6.2	Target Information Dialog Box.....	23-29

Chapter 24 Monitor Function

1		Monitoring with WindO/I-NV3	24-1
	1.1	How the Monitor Function in WindO/I-NV3 is Used	24-1
	1.2	Debugging in WindO/I-NV3.....	24-4
	1.3	Display the Value of Device in Popup	24-16
	1.4	Highlighting Objects While Satisfying Conditions	24-16
	1.5	Switching the Screen of the Touch.....	24-17
	1.6	Open Current Screens.....	24-17
2		Monitoring on the Touch	24-18
	2.1	How the Monitoring Function is Used	24-18
	2.2	Device Monitor	24-19
	2.3	Ladder Monitor.....	24-23

Chapter 25 Data Transfer Function

1		Project Transfer Function.....	25-1
	1.1	How the Project Transfer Function is Used.....	25-1
	1.2	Project Data Transfer Procedures.....	25-1
	1.3	Converting Project Data for Transfer	25-2
	1.4	Using Key Buttons, Multi-Buttons, or Multi-Commands to Transfer Project Data..	25-5
	1.5	Precautions.....	25-6

Chapter 26 External Memory Devices

1		USB Flash Drives	26-1
	1.1	How the USB Flash Drive Function is Used	26-1
	1.2	Specifications.....	26-1
	1.3	File Structure	26-2
	1.4	Reading/Writing Data	26-3
	1.5	Setting the External Memory Folder	26-12
	1.6	Deleting Files on the USB Flash Drive.....	26-13
	1.7	Formatting the USB Flash Drive	26-14
	1.8	USB Popup Screen Function	26-15
	1.9	Precautions.....	26-17
2		USB Autorun Function.....	26-18
	2.1	Overview of the USB Autorun Function	26-18
	2.2	USB Autorun Function Configuration Procedure	26-19
	2.3	Creating a USB Autorun Definition File	26-22
	2.4	USB Autorun Function Security	26-26

Chapter 27 Internal Devices

1	Bit Devices	27-1
1.1	HMI Device Addresses	27-1
1.2	Control Device Addresses.....	27-4
2	Word Devices	27-9
2.1	HMI Device Addresses	27-9
2.2	Control Device Addresses.....	27-12

Chapter 28 Touch Setup

1	Maintenance Screen.....	28-1
1.1	Maintenance Screen Overview.....	28-1
1.2	Displaying the Maintenance Screen.....	28-2
1.3	Adjusting Screen Brightness.....	28-2
2	System Mode Overview	28-3
2.1	System Mode Screens.....	28-3
2.2	Names and Layout of Setup Menus.....	28-4
3	Settings	28-5
3.1	Initial Setting	28-5
3.2	Clock Setting	28-9
3.3	Run.....	28-9
3.4	System Info. (System Information)	28-9
3.5	Top Page	28-10
3.6	Self Diag. (Self Diagnosis).....	28-10

Chapter 29 SmartAXIS Specifications

1	Touch	29-1
1.1	Packing Contents	29-1
1.2	Type Number	29-2
1.3	Part Names.....	29-3
1.4	External Interfaces.....	29-5
1.5	Specifications.....	29-14
1.6	Dimensions.....	29-16
1.7	Installation	29-18
1.8	Attaching Cartridges (FT1A-*14KA/SA only)	29-22
1.9	Wiring.....	29-23
1.10	USB Cable Lock Pin Attachment.....	29-24
1.11	Maintenance and Inspection	29-26
2	Analog Cartridge.....	29-29
2.1	Packing Contents	29-29
2.2	Type Number	29-29
2.3	Part Names.....	29-29
2.4	Specifications.....	29-30
2.5	Dimensions.....	29-32
2.6	Installation	29-32
2.7	Wiring.....	29-33

Chapter 30 Troubleshooting

1	Error Messages.....	30-1
1.1	Errors Displayed on the Screen.....	30-1
1.2	Low Battery Voltage	30-2
2	Error Information.....	30-3
2.1	General Error Codes	30-3
2.2	Program Execution Error	30-5
3	Handling Problems.....	30-6
3.1	When You Cannot Download Project Data	30-6
3.2	When the Backlight is OFF and the Buzzer Sounds.....	30-6
3.3	When a Problem Occurs with a Control Function.....	30-7

Appendix

1	Color Number Correspondence Table.....	A-1
2	View Browser	A-2
3	Color Palette	A-3
4	Pattern Palette	A-4
5	Text Alignment	A-5
6	Ladder Program.....	A-8
6.1	Processing in One Scan.....	A-8
6.2	Executing Program Instructions	A-8
6.3	Breakdown of END Processing Time.....	A-8
6.4	Execution Times for Instructions.....	A-9
6.5	Instruction Bytes.....	A-11
7	FBD Program.....	A-13
7.1	Processing in One Scan.....	A-13
7.2	FBD Program Processing	A-13
7.3	Breakdown of Scan End Processing Time	A-13
7.4	FB Execution Time.....	A-14
7.5	FBD Program Limitation	A-15

Index

This chapter describes SmartAXIS functions and system configuration examples.

1 About the SmartAXIS

The SmartAXIS is available in three types: the SmartAXIS Touch, the SmartAXIS Pro, and the SmartAXIS Lite. The SmartAXIS Touch is equipped with the HMI functions of an operator interface and PLC control functions. In addition to the functions of control and communication as a PLC, the SmartAXIS Pro is equipped with an LCD and operation buttons on the front of the module. The SmartAXIS Lite is equipped with the various control and communication functions as a PLC. This document describes the SmartAXIS Touch. Unless otherwise specified, SmartAXIS refers to FT1A Series SmartAXIS Touch. For the SmartAXIS Pro and Lite, refer to the "SmartAXIS Pro/Lite User's Manual".

The Touch is a small-size programmable controller that is fully equipped with powerful basic functions, various communication functions and HMI functions of an operator interface. Use WindO/I-NV3 for creating and managing screens and data to used with the Touch.

1.1 Type Numbers

The notation for SmartAXIS Touch type numbers is as follows.

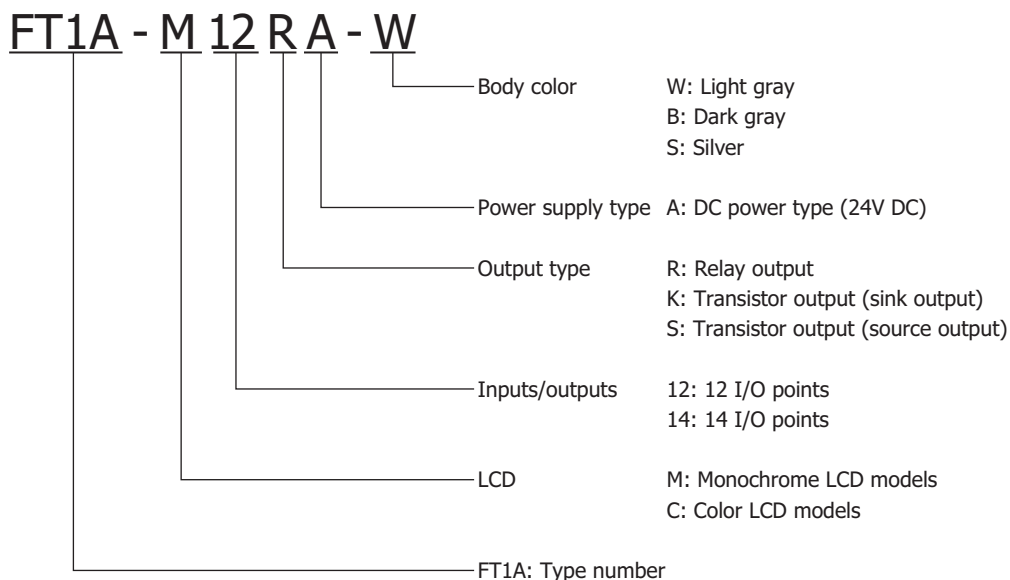

For a list of models, refer to Chapter 29 "SmartAXIS Specifications".

1.2 Features for the Touch

This section describes the features of the Touch.

The Touch is high-performance programmable controller in a compact package and is equipped with high speed counters. The Touch enables you to build optimum systems to automate factories or control production lines.

■ Powerful display functions

The Touch is equipped with an LCD and the same display functions as the MICRO/I. You can monitor and modify values of devices and monitor basic instructions.

Also, by creating screens and programming control functions, you can display the current time, bar charts, scrolling messages, or simple text on the LCD screen.

■ 32-bit and Floating Point Data Types

For arithmetic commands, it is possible to unsigned 32-bit (D: double word) and signed 32-bit (L: long) arithmetic processes, and floating point (F: float) arithmetic processes.

■ Supports Various Languages

Japanese, Roman, Chinese, Taiwanese, Central European, Baltic, and Cyrillic, languages are all supported. In addition to the included fonts you can also use any of the Windows fonts on your computer.

1.3 Special Functions for the Touch

This section describes the functions of the Touch.

● I/O Related Functions

■ Catch Input

The catch input allows it to receive short input pulses from sensors without regard to the scan time. A maximum of four catch inputs can be used.

■ Input Filter

The input filter can be adjusted according to the width of input signals to reject input noises. Selectable input filter values to pass input signals are 0 millisecond, and 3 through 15 milliseconds in 1 millisecond increments.

■ Interrupt Input

The interrupt input can be used to call an interrupt program to respond to an external input that requires a response faster than the scan time. A maximum of four interrupt inputs can be used. This can only be used when ladder program is selected as the programming language for control function.

■ Stop and Reset Inputs

Stop input is a function to stop the ladder program or FBD program operation for the Touch. Reset input is a function to stop the ladder program or FBD program operation for the Touch and clear the value of control devices. Any input terminal on the Touch can be designated as a stop or reset input to control the Touch operation.

■ Analog Input

Analog input of 0 to 10V DC or 4 to 20 mA can be converted to a digital value of 0 to 1000. A maximum of two inputs can be used as analog inputs.

■ Analog Output

Analog output converts a digital value between 0 and 1000 to analog value of 0 to 10V DC or 4 to 20 mA and outputs it. A maximum of two outputs can be used as analog outputs.

■ Remote I/O

When the number of Touch inputs and outputs is insufficient, the number of inputs and outputs can be expanded to a maximum of 156 points by connecting the SmartAXIS Pro/Lite as remote I/O slaves. With the remote I/O function, the analog inputs on the SmartAXIS that are connected as remote I/O slaves can also be used.

■ Expanded Analog I/O

Expanded analog I/O allows the Touch to handle analog inputs for voltage, current, thermocouples, and Resistance thermometer outputs for voltage and current by using analog cartridges. The Touch can be expanded to a maximum of four analog inputs and outputs.

● Pulse I/O Functions

■ High-speed Counter

This function counts high-speed pulse inputs that cannot be measured in normal ladder program or FBD program processing.

Use this function for applications such as positioning control with a rotary encoder or motor control. The Touch can use singlephase high-speed counters and two-phase high-speed counters. A maximum of four single-phase high-speed counters and a maximum of one two-phase high-speed counters can be used simultaneously.

Example: Controlling a motor by counting two-phase pulse input with a high-speed counter

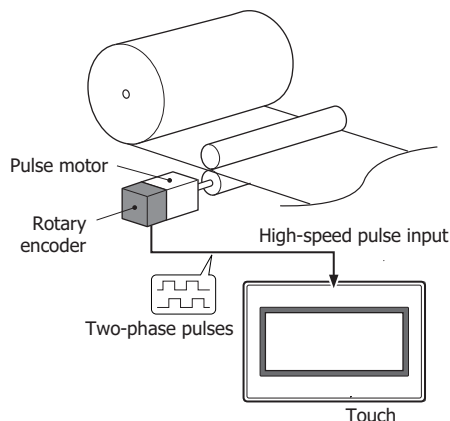

■ Frequency Measurement

This function measures the frequency of pulses input to an input terminal. The frequencies of a maximum of one input can be measured.

● Convenient Functions

■ Calendar/Clock

The Touch features a real-time clock on-board. Using the calendar and clock function, the Touch can operate according to the current date and time. These functions can be used to control time schedule for lighting or air conditioning equipments.

■ Security function

The project in the Touch can be protected against reading and/or writing by including a password in the project. This function is effective for security of projects.

■ "Keep" or "Clear" Designation of Touch Data

Internal relays, shift register bits, counter current values, and data register values of the control devices can be designated to be kept or cleared when the Touch is powered down. All or a specified range of these devices can be designated as keep or clear types.

■ RUN/STOP Selection at Startup when "Keep" Data is Broken

When data to be kept such as "keep" designated counter values are broken while the Touch is powered down, the user can select whether the ladder program starts to run or not to prevent undesirable operation at the next startup.

■ Log Data

The function allows values of devices to be logged under specified sampling conditions. The sampled values of devices are saved in internal memory along with the time of sampling.

■ Timer Interrupt

The timer interrupt can be used to call an interrupt program at a predetermined interval of time without being affected by the scan time. This can only be used when ladder program is selected as the programming language for control function.

■ PID control

PID control performs temperature control and other types of control using a PID (proportional, integral, derivative) arithmetic algorithm. PID control can be performed by automatically calculating the optimal PID value using the auto tuning function.

This can only be used when ladder program is selected as the programming language for control function.

2 About the WindO/I-NV3

WindO/I-NV3 is software that is exclusively designed for operation with the Touch, for specifying settings and creating screens and the ladder program or FBD program. The set of data made up of settings, created screens, and ladder program or FBD program is called a project.

Using WindO/I-NV3, you create a project and then download it to the Touch, to build the interface necessary for operation.

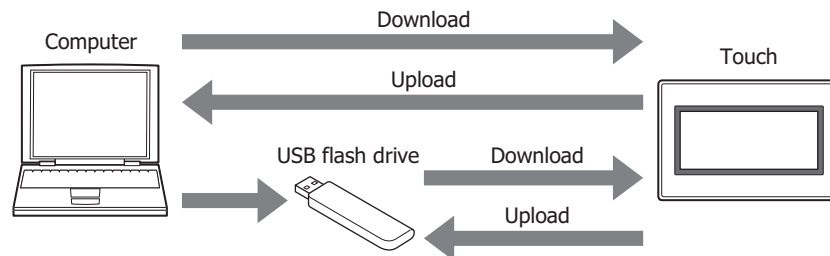

3 Operating Modes

The Touch includes multiple modes, so you switch between modes as and when necessary. These modes are called operating modes. The functions and the operations and conditions for switching are as follows.

Mode	Functions	Conditions required for switching to the mode
Run Mode	This is the mode at the time of executing project data. The created screen is displayed and the ladder program or FBD program is executed.	<ul style="list-style-type: none"> • Turn ON the power to the Touch. • Press Run on the Top Page in the System Mode. • The download of the project data is completed.
System Mode	Perform initial settings, clock settings, self-diagnosis, etc. for the Touch.	<ul style="list-style-type: none"> • Press down for 3 seconds or more at the top left corner of the screen to display the Maintenance screen, and then press System Mode. • Using the screen switching button, multi-buttons, screen switch or multi commands, switch to the System Mode. • All data is cleared using WindO/I-NV3. • Write the System Area 1 Display screen number (address+0) to FFFFh.
Monitor Mode	Monitor Mode is used for monitoring values of devices using WindO/I-NV3. While in Monitor mode, the words "Monitor mode" flash at the bottom left of the screen of the Touch.	On the WindO/I-NV3 Online tab, in the Monitor group, click Start Monitor .
Data Transfer	Transferring data between a computer and the Touch.	<ul style="list-style-type: none"> • Download project data.



- When switched to System Mode, operation of the Touch stops.
- To display the Maintenance Screen by pressing down for 3 seconds or more at the top left of the screen, the **Enable Maintenance** check box from the **System Settings** tab of the Project Settings dialog box must be checked.



For details about Maintenance Mode, refer to Chapter 28 "1 Maintenance Screen" on page 28-1.

4 Flow from Screen and Ladder Program or FBD Program Creation to Run Operation

The following flowchart describes the sequence of step from the screen and the ladder program or FBD program creation for the Touch to the Run operation.

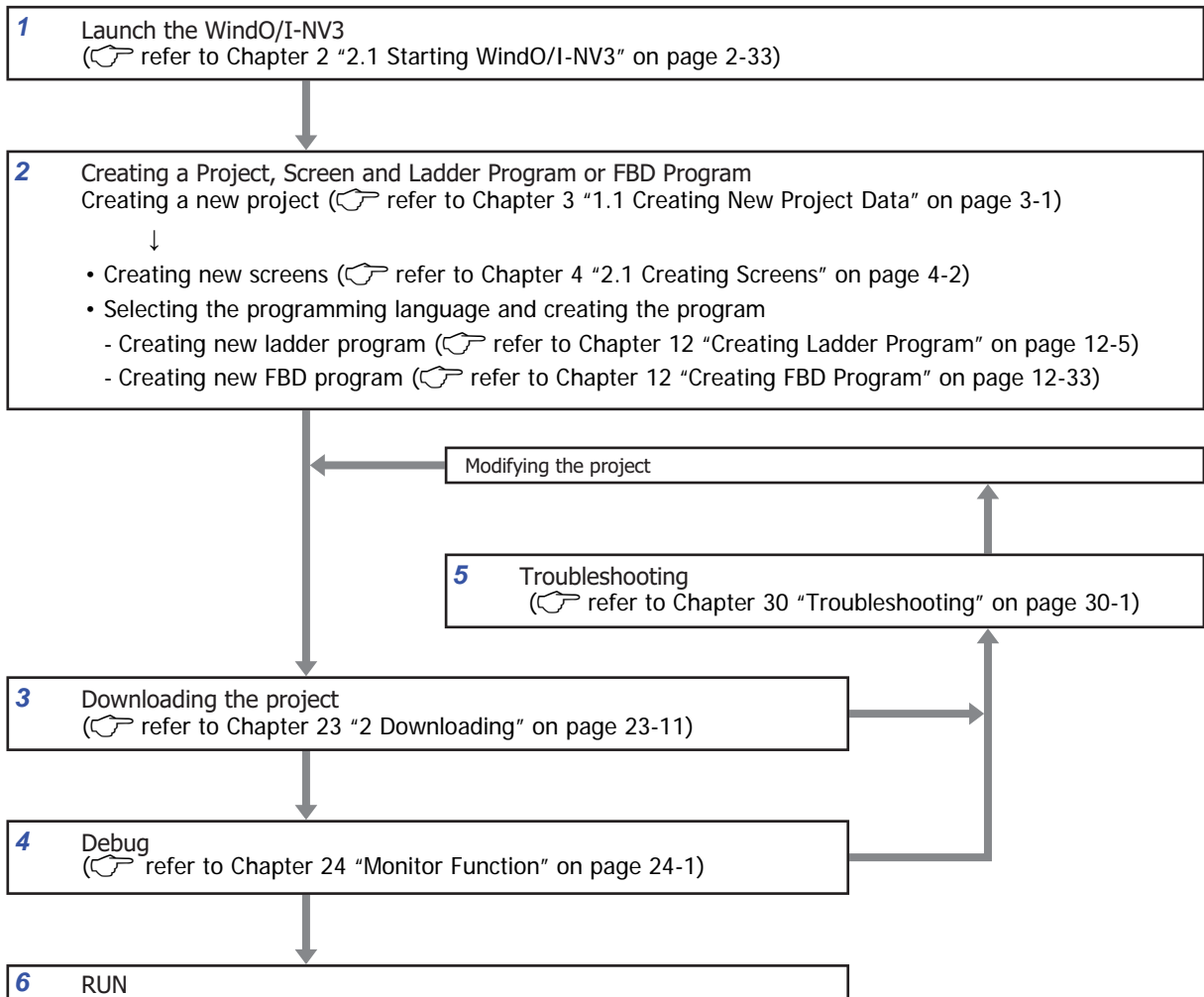

1 Launch WindO/I-NV3
Launch WindO/I-NV3.

2 Creating a Project, Screen and ladder program or FBD program
Create a project and performing various settings.
Create display screens and ladder program or FBD program.

3 Downloading the project
Connect the computer to the Touch using a USB cable or Ethernet cable, and download the created project data to the internal memory of the Touch.

4 Debug
Using the monitor function, you can correct created project data while confirming actual actions.

5 Troubleshooting
If there is a module or communication-related problem with the Touch, or a problem with the screen settings, the ladder program or the FBD program, an appropriate message is displayed at the top of the screen.
In addition, error information is saved to a special data register. By referring to this information and repeatedly correcting the project, downloading, and debugging, the project can be completed.

6 RUN
Starting communication with the external device and execute various functions according to the project settings.

Chapter 2 WindO/I-NV3 Basic Operations

This chapter describes the minimum system requirements for WindO/I-NV3, how to start and exit it, and the configuration of its screens and menus.

1 WindO/I-NV3 Specifications

1.1 Available Data

● Data types

Data type is the format of the data related to the minimum and maximum values of data that can be processed by a part and handling of negative and real numbers.

Data types and data ranges that can be used on the Touch and WindO/I-NV3 are listed below.

Data type	Required word count	Processable data range
BIN16 (+)	1	0 to 65535
BIN16 (+/-)	1	-32768 to 32767
BIN32 (+)	2	0 to 4294967295
BIN32 (+/-)	2	-2147483648 to 2147483647
BCD4	1	-999 to 9999
BCD8	2	-9999999 to 99999999
float32	2	-3.4×10^{38} to -1.18×10^{-38} , 0, 1.18×10^{-38} to 3.4×10^{38}



WindLDR data types are displayed as follows: BIN16(+) as W (word), BIN16(+/-) as I (integer), BIN32(+) as D (double word), BIN32(+/-) as L (long), and float32 as F (float).

● Numeric value handling by data type

Data stored in devices is handled as described below.

Data type	Data handling
BIN16 (+)	<p>Data is handled as an unsigned 16-bit integer.</p>
BIN16 (+/-)	<p>Data is handled as a signed 16-bit integer. If the sign bit (bit 15) is 1, the value is two's complement.</p>
BIN32 (+)	<p>Handled as an unsigned 32-bit integer with the starting address as the lower word.</p>
BIN32 (+/-)	<p>Handled as a signed 32-bit integer with the starting address as the lower word. If the sign bit (bit 31) is 1, the value is two's complement.</p>
BCD4	<p>Data is handled as a four digit (16-bit) binary-coded decimal value. Each four bits from bit 0 to bit 11 is handled as the absolute value for the 1st to 3rd digit. Bit 12 to bit 15 is handled as the minus sign (-) when its value is F (hex) and it is handled as the absolute value for the 4th digit when 0 to 9 (hex).</p>

Data type	Data handling
BCD8	<p>Data is handled as an eight digit (32-bit) binary-coded decimal value.</p> <p>Each four bits from bit 0 to bit 27 is handled as the absolute value for the 1st to 7th digit.</p> <p>Bit 28 to bit 31 is handled as the minus sign (-) when its value is F (hex) and it is handled as the absolute value for the 8th digit when 0 to 9 (hex).</p>
float32	<p>Data is handled as a 32-bit floating-point real number. The number of significant digits is 6 digits. The floating-point type data format conforms to the IEEE (The Institute of Electrical and Electronics Engineers) standard for the single precision storage format as explained next.</p> <p>Single precision floating-point values in IEEE 754 (32 bits)</p> <p>Single precision floating-point values in IEEE 754 are expressed with a total of 32 bits (2 words) using 1 bit for the sign <i>s</i>, 8 bits for the exponent <i>e</i>, and 23 bits for the significand <i>f</i>. The sign bit indicates the sign of the expressed value (positive or negative). The exponent is an 8 bit signed integer with a value from -128 to 127.</p> <p>Example:</p> <p>If all bits are 0, the value is "0".</p>

! The internal representation of float32 is described here, but the data for float32 (floating-point real numbers) is handled with a special bit configuration, so do not directly access the bits.

Example: Data handling

Data type	Storing 0FFF (hex) in LDR10	Storing FFFF (hex) in LDR10
BIN16 (+)	<p>0FFF (hex) is handled as 4095 (dec).</p>	<p>FFFF (hex) is handled as 65535 (dec).</p>
BIN16 (+/-)	<p>0FFF (hex) is handled as 4095 (dec).</p>	<p>Sign bit is 1, so FFFF (hex) is two's complement, handled as -1 (dec).</p>
Data type	Storing 0FFF (hex) in LDR10, FFFF (hex) in LDR11	Storing FFFF (hex) in LDR10, FFFF (hex) in LDR11
BIN32 (+)	<p>0FFFFFFF (hex) is handled as 268435455 (dec).</p>	<p>FFFFFFF (hex) is handled as 4294967295 (dec).</p>

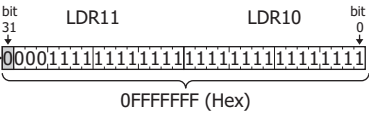
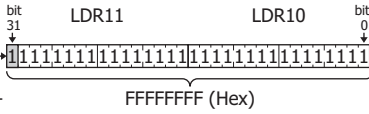
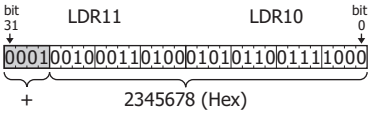
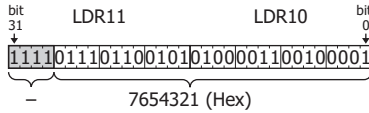
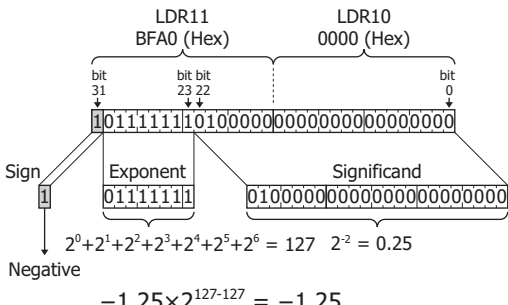
Data type	Storing 0FFF (hex) in LDR10, FFFF (hex) in LDR11	Storing FFFF (hex) in LDR10, FFFF (hex) in LDR11
BIN32 (+/-)	 <p>The sign bit is 0, so the positive number 0FFFFFFF (hex) is handled as 268435455 (dec).</p>	 <p>Sign bit is 1, so two's complement of the negative number FFFFFFFF (hex), handled as -1 (dec).</p>
BCD8	 <p>The sign is 1 (hex), so the binary-coded decimal value of the positive number 2345678 (hex), handled as 12345678 (dec).</p>	 <p>The sign is F (hex), so the binary-coded decimal value of the negative number 7654321 (hex), handled as -7654321 (dec).</p>
float32	<p style="text-align: center;">Storing 0000 (hex) in LDR10, BFA0 (hex) in LDR11</p>  <p>Sign: 1 Exponent: 01111111 Significand: 010000000000000000000000</p> <p>$2^0+2^1+2^2+2^3+2^4+2^5+2^6 = 127$ $2^{-2} = 0.25$</p> <p>Negative $-1.25 \times 2^{127-127} = -1.25$</p>	

 In the data types BIN32 (+), BIN32 (+/-), BCD8, and float32, two words (upper word and lower word) are used for a single value. The Touch and external device communicate data in device addresses in one word units, so when the upper word and lower word are sent in separate packets, the value may have already changed when the data for both words is received, which may cause an unexpected result.

● Indirect Read and Indirect Write Settings

The indirect specification of a device address means to add a value (indirect value) to the address of the configured device and use that address as the actual read source or write destination. You can change the read source or write destination address just by changing this indirect value.

Indirect read

Add the indirect value to the address of the configured device as the read source and read the value of device specified indirectly.

Example: To read a value of device specified indirectly into LDR200

When the device address configured as the read source is LDR10 and the indirect value's device address is D21, if 4 (indirect value: 4) is set in D21, the device address of the value actually read is LDR14.

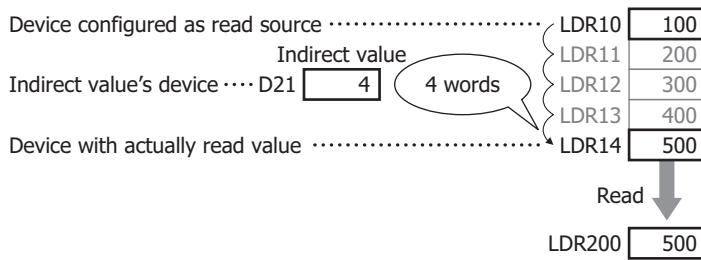

Indirect write

Add the indirect value to the address of the configured device as the write destination and write to the value of device specified indirectly.

Example: To write the value in LDR20 to an indirectly specified device

When the device address configured as the write destination is LDR100 and the indirect value's device address is D20, if 3 (indirect value: 3) is set in D20, the device address of the value actually written is LDR103.

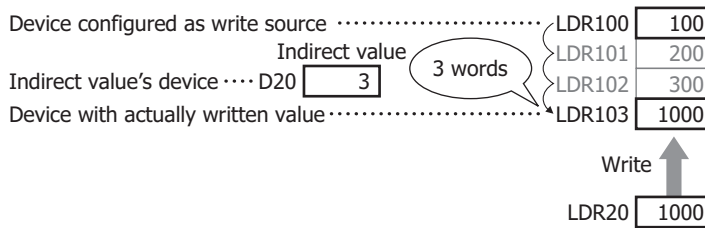

Parts you can indirectly read and indirectly write

Part	Indirect read	Indirect write
Word Button	YES	YES
Multi-Button	YES	YES
Numerical Input	YES	YES
Character Input	YES	YES
Numerical Display	YES	NO
Word Write Command	YES	YES
Script Command	YES	YES
Multi-Command	YES	YES

 • Enter the value for indirect values as the data type BIN16 (+). Indirect values can be set in the range of 0 to 32767. If you enter a value for the indirect value outside this range, the value before the indirect value changes is maintained when reading. When writing, "Device range error" is displayed. In scripts however, enter a value for the data type set in the script.

• For indirect device reading, decide the read source address after the indirect value changes and after the screen changes, and then read the value of device. For external device addresses, communication to read the value of device from a external device takes time, so if data is transferred or arithmetic operations are executed before the indirect read is finished, processing cannot be executed and the following error is displayed.

Word Button, Word Write Command: Indirect device error

Script Command: Script error

1.2 Available Text

● Font

Supported Languages

The Touch can display multiple fonts by installing them. In addition to the fonts installed on the Touch, all Windows fonts displayed on your computer can be used on the display.

Font	Description
Fonts installed in the Touch	Fonts to be pre-loaded on the Touch. Japanese, European, Chinese, Korean, Taiwanese, Central European, Baltic and Cyrillic fonts can be installed on the Touch. The installed fonts installed can be changed as needed using WindO/I-NV3, which helps save and efficiently operate the user capacity.
Windows Font	All fonts used on the computer can be displayed on the Touch. The Windows fonts allow you to display expressive characters on the Touch screen as needed. Windows fonts are downloaded as part of the project data.

In addition, the Touch has a function that switches between two or more text groups dynamically. With this function, the registration text of buttons can be switched to different languages according to the conditions.

For details, refer to Chapter 19 "Text Group" on page 19-1.

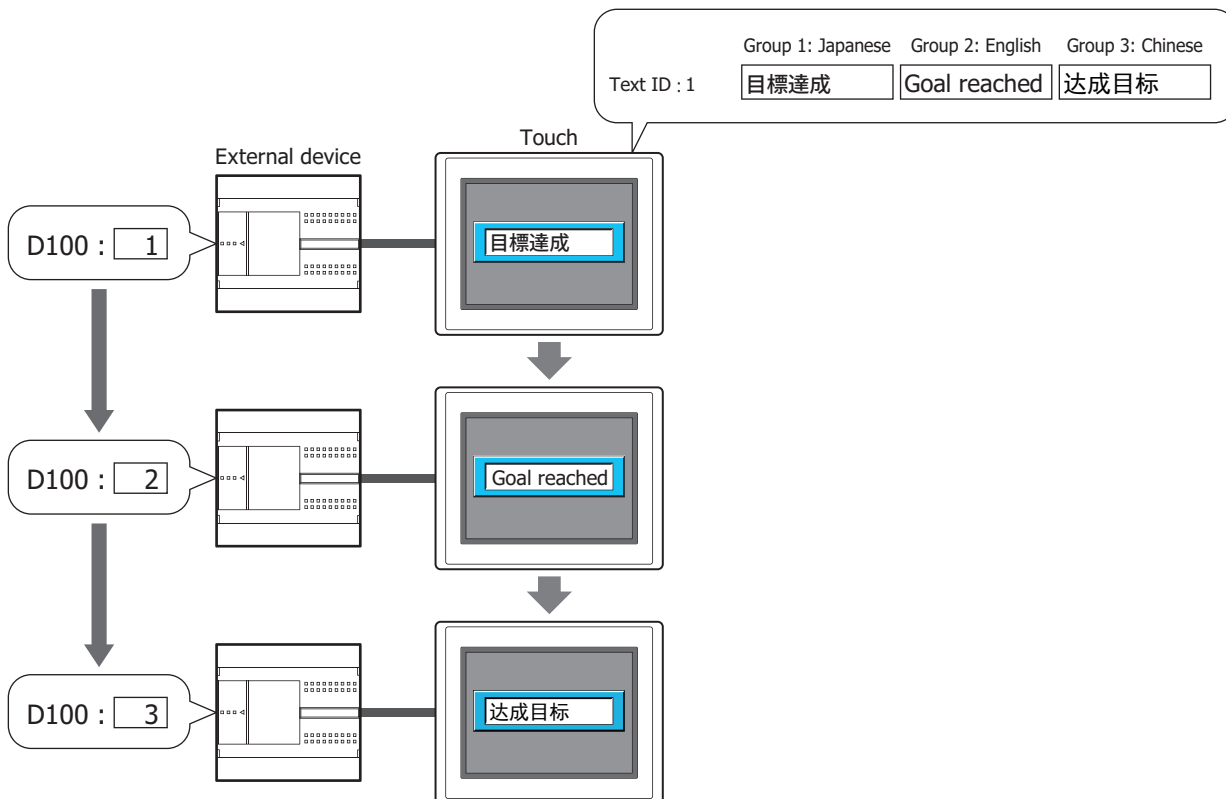

Installed Fonts in the Touch

Font Name		Code System	Language
Standard Fonts	Japanese	JIS 8-bit code JIS level-1 and level-2 kanji sets	Japanese
	English	ISO 8859-1 (Latin1)	Icelandic, Irish, Italian, English, Dutch, Swedish, Spanish, Danish, German, Norwegian, Portuguese, Finnish, Faeroese, French
Optional Fonts	Japanese large font (first standard)	JIS level-1 kanji set	* Install this font to achieve a sharper display of enlarged JIS level-1 kanji set. Refer to "High-quality Fonts" on page 2-9.
	Japanese large font (second standard)	JIS level-2 kanji set	* Install this font to achieve a sharper display of enlarged JIS level-2 kanji set. Refer to "High-quality Fonts" on page 2-9.
	Chinese	GB2312	Chinese
	Korean	KSC5601	Korean
	Taiwanese	BIG5	Taiwanese
	European large font	ISO 8859-1 (Latin1)	* Install this font to achieve a sharper display of enlarged European fonts. Refer to "High-quality Fonts" on page 2-9.
	Central European	ANSI1250	Czech, Hungarian, Polish, Slovak, Slovene
	Baltic	ANSI1257	Estonian, Latvian, Lithuanian, Greenlandic, Lappish
Cyrillic	ANSI1251	Bulgarian, Belarusian, Ukrainian, Serbian, Macedonian, Russian	



- Japanese, European, and European large font are factory-installed. The standard fonts cannot be replaced; however, the optional fonts can be downloaded from the WindO/I-NV3.
- The Touch displays the single-byte parts of Chinese, Taiwanese, and Korean with ISO 8859-1, and supports Hangul characters only in the double-byte part of Korean.

Available Fonts for Parts

Parts	Description	Touch installed Font ^{*1}	Windows Font
Buttons	Bit Button	YES	YES
	Word Button	YES	YES
	Goto Screen Button	YES	YES
	Key Button	YES	YES
	Keypad	YES	YES
	Selector Switch	YES	YES ^{*3}
Lamps	Pilot Lamp	YES	YES
	Multi-State Lamp	YES	YES
Data Displays	Numerical Input	YES	NO
	Character Input	YES	NO
	Message Display	YES	YES ^{*2*3}
	Message Switching Display	YES	YES ^{*3}
	Alarm List Display	YES	YES ^{*3}
	Alarm Log Display	YES	YES ^{*3}
	Numerical Display	YES	NO
Charts	Calendar	YES	NO
	Bar Chart	YES	YES ^{*3}
	Line Chart	YES	YES ^{*3}

*1 To use a Touch-installed font, the font should be downloaded from the WindO/I-NV3 in advance.

*2 Windows font can be used for fixed text only. Only the Touch-installed font can be used for the read device data code for the Message Display.

*3 Windows font can be used only when the **Use Text Manager** check box is selected.

Font Size

	Font Name	Code System	Size
Optional Fonts	Japanese large font (first standard)	JIS level-1 kanji set	477KB
	Japanese large font (second standard)	JIS level-2 kanji set	424KB
	Chinese	GB2312	238KB
	Korean	KSC5601	109KB
	Taiwanese	BIG5	422KB
	European large font	ISO 8859-1 (Latin1)	102KB
	Central European	ANSI1250	6KB
	Baltic	ANSI1257	6KB
	Cyrillic	ANSI1251	6KB



The download size of font data is adjusted in multiples of 128KB.

The download size of font data is 128KB when the font size is 0KB or 128KB and smaller.

Example: When downloading Japanese large font (level-1 kanji set), Chinese, and European large fonts:

Font	Size
Japanese large font (first standard)	477KB
Chinese	238KB
European large font	102KB
Total size of the font data	817KB

Download size of font data	896KB (817KB is adjusted in multiples of 128KB.)
----------------------------	--

Example: When downloading Chinese and Korean fonts:

Font	Size
Chinese	238KB
Korean	109KB
Total size of the font data	347KB

Download size of font data	384KB (347KB is adjusted in multiples of 128KB.)
----------------------------	--

Example: When downloading all fonts:

Font	Size
Japanese large font (first standard)	477KB
Japanese large font (second standard)	424KB
Chinese	238KB
Korean	109KB
Taiwanese	422KB
European large font	102KB
Central European	6KB
Baltic	6KB
Cyrillic	6KB
Total size of the font data	1790KB

Download size of font data	1792KB (1790KB is adjusted in multiples of 128KB.)
----------------------------	--

● High-quality Fonts

The high-quality fonts are the Japanese large fonts (first standard/second standard), and European fonts.

If you download high-quality fonts and select **Use large font** on the System tab in the Project Setting dialog box, the Touch can replace some of the optional fonts with the high-quality fonts.

Scaled text with a background color is replaced and displayed with these fonts for a more attractive look.

High-quality European Font Display (Size 8x16)

H \ W	0.5	1	2	3	4	5	6
0.5	AB09	AB09	AB09	AB09	AB09	AB09	AB09
1	AB09	AB09	AB09	AB09	AB09	AB09	AB09
2	AB09	AB09	AB09	AB09	AB09	AB09	AB09
3	AB09	AB09	AB09	AB09	AB09	AB09	AB09
4	AB09	AB09	AB09	AB09	AB09	AB09	AB09
5	AB09	AB09	AB09	AB09	AB09	AB09	AB09
6	AB09	AB09	AB09	AB09	AB09	AB09	AB09
7	AB09	AB09	AB09	AB09	AB09	AB09	AB09
8	AB09	AB09	AB09	AB09	AB09	AB09	AB09

H \ W	7	8
0.5	AB09	AB09
1	AB09	AB09
2	AB09	AB09
3	AB09	AB09
4	AB09	AB09
5	AB09	AB09
6	AB09	AB09
7	AB09	AB09
8	AB09	AB09

High-quality Japanese Font Display (Size 8x16)

H \ W	0.5	1	2	3	4	5	6
	0.5	AB09	AB09	AB09	AB09	AB09	AB09
1	AB09	AB09	AB09	AB09	AB09	AB09	AB09
2	AB09	AB09	AB09	AB09	AB09	AB09	AB09
3	AB09	AB09	AB09	AB09	AB09	AB09	AB09
4	AB09	AB09	AB09	AB09	AB09	AB09	AB09
5	AB09	AB09	AB09	AB09	AB09	AB09	AB09
6	AB09	AB09	AB09	AB09	AB09	AB09	AB09
7	AB09	AB09	AB09	AB09	AB09	AB09	AB09
8	AB09	AB09	AB09	AB09	AB09	AB09	AB09

H \ W	7	8
	0.5	AB09
1	AB09	AB09
2	AB09	AB09
3	AB09	AB09
4	AB09	AB09
5	AB09	AB09
6	AB09	AB09
7	AB09	AB09
8	AB09	AB09

High-quality Japanese Font Display (Size 16x16)

H \ W		W						
		0.5	1	2	3	4	5	6
H	0.5	あいう	あいう	あいう	あいう	あいう	あいう	あいう
	1	あいう	あいう	あいう	あいう	あいう	あいう	あいう
	2	あいう	あいう	あいう	あいう	あいう	あいう	あいう
	3	あいう	あいう	あいう	あいう	あいう	あいう	あいう
	4	あいう	あいう	あいう	あいう	あいう	あいう	あいう
	5	あいう	あいう	あいう	あいう	あいう	あいう	あいう
	6	あいう	あいう	あいう	あいう	あいう	あいう	あいう
	8	あいう	あいう	あいう	あいう	あいう	あいう	あいう

H \ W		W	
		7	8
H	0.5	あいう	あいう
	1	あいう	あいう
	2	あいう	あいう
	3	あいう	あいう
	4	あいう	あいう
	5	あいう	あいう
	6	あいう	あいう
	8	あいう	あいう



- When the high-quality fonts have not been downloaded into the Touch, the standard fonts are used even if **Use large font** is selected.
- When the Character Input part display font size is 8x16, high-quality fonts are not displayed even if **Use large font** is selected.

● Windows Font

Selecting Windows Font for the Font property gives you access to all of the fonts installed on your computer for use on Drawings and Parts. This allows you to display fonts and languages that are not installed on the Touch.

Windows Font Settings

Windows Font settings are made in the Font Settings dialog box.

- 1 Click **Change** in the **Windows Font** group on the properties dialog box for Drawings, Parts, or on Text Manager.

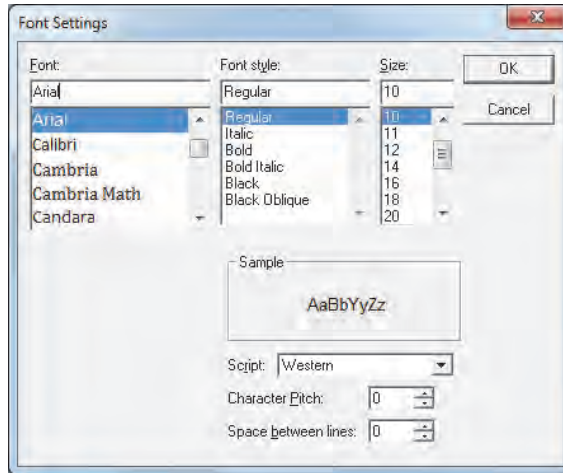

- 2 Set each item, and then click **OK**.

■ Font

Select the font to use.

■ Font style

Select italic, bold, or other style.

■ Size

Select the size of the text.

■ Sample

Shows a preview using the specified font.

■ Character Pitch

Specify character spacing from 0 to 100.

■ Space between lines

Specify line spacing from 0 to 100.

■ Script

Select the character set code.



- The right end of the text may have missing dots if **Font style** is set to **Italic**. You can remedy this by adding an extra space at the end of the line.
- An alternate font will be used if the Project Data uses a font that does not exist on the computer. This means that text will appear differently if the Project Data is opened on another computer.
- The same font may also appear differently for different OS versions.

Using Windows Fonts

This section describes how to use Windows Fonts.

 Selecting Windows Font for the Font property dialog box for the Text from the Drawings and Parts disables the following options:

- Style: The style set under **Windows Font** will be used.
- Magnification: The width by height magnification will be set to 1 x 1. Note, **Magnification** can be selected on the Message Display, Message Switching Display, and Alarm List Display parts, but will not be reflected on the actual text displayed. To use scrolling on these parts, adjust the display area for text using **Magnification**.

To register and use a Windows Font in Text Manager

Applicable Drawings	Text	
Applicable Parts	Buttons	Bit Button, Word Button, Goto Screen Button, Key Button, Keypad, Selector Switch
	Lamps	Pilot Lamp, Multi-State Lamp
	Data Displays	Message Display, Message Switching Display, Alarm List Display, Alarm Log Display
	Charts	Bar Chart, Line Chart

- 1 Select the **Use Text Manager** check box on the Properties dialog box for the Text from the Drawings and Parts.
 - The **Use Text Manager** check box may appear in different locations depending on the part. This table shows where to find this property:

Part	Location
Text	Properties of Text dialog box
Bit Button, Word Button, Goto Screen Button, Key Button, Selector Switch, Pilot Lamp, Multi-State Lamp	Registration Text tab
Keypad	Properties of Keypad dialog box
Message Display	General tab
Message Switching Display	Message tab
Bar Chart, Line Chart	Scale tab

- The Alarm List Display and Alarm Log Display parts are designed to use the text registered in Text Manager so the **Use Text Manager** check box is not shown.

- 2 Specify the Text ID for the Windows Font set in Text Manager.

 Using the Text ID for the Windows Font set in Text Manager disables these settings in the Properties dialog box:

- Align Text: Multiple lines of text are shown aligned center-left when **Center** is selected. Text is shown with right-indented left-aligned when **Right** is selected. With right-indented left-aligned formatting, the line containing the most number of characters is aligned on the right end while the other lines are aligned to the left end of that line.

- Vertical Writing: Horizontal writing is used.
- The maximum number for the unit in the Numerical Input and Numerical Display parts is 4 characters. The fifth character and any characters beyond that will appear outside the part.
- In the Message Display, variable text “\@” appears as is.
- With the Alarm List Display and Alarm Log Display, line spacing is not automatically adjusted based on the size of the text. Adjust it using the **Line Spacing** property on the **Format** tab.
- If text containing a carriage return is used for a label on a Bar or Line Chart, or for an Alarm List Display or Alarm Log Display part, it will appear truncated after the carriage return if a non-Windows Font is used. The entire text, including the carriage return, is shown when using a Windows Font.

To select a font in the Properties dialog box

Applicable Drawings	Text	
Applicable Parts	Buttons	Bit Button, Word Button, Goto Screen Button, Key Button, Keypad
	Lamps	Pilot Lamp, Multi-State Lamp

Select **Windows** for **Font** on the Properties dialog box for the Text from the Drawings or Parts.

The **Font** property may appear in different locations depending on the part. This table shows where to find this property:

Part	Location
Text	Properties of Text dialog box
Bit Button, Word Button, Goto Screen Button, Key Button, Pilot Lamp, Multi-State Lamp	Registration Text tab
Keypad	Properties of Keypad dialog box

● Character Code Table

Using the Character Code Table

Example: Finding the character code for the character "a" in the table.

	0	1	2	3	4	5	6	7	8	9	A	B	C	D	E	F	Upper 4 bits of the code (hexadecimal)
0				0	@	P	a	p				°	À	Đ	à	ă	
1		!	1	^	Q	a	q				i	±	Á	Ñ	á	ñ	
2		"	2	B	R	b	r				∅	²	Ã	Ò	ã	ò	
:		#	3	C	S	c	s				£	³	Ä	Ó	ä	ó	

Lower 4 bits of the code (hexadecimal)

The upper four bits of the code are hexadecimal 6.
 The lower four bits of the code are hexadecimal 1.
 Therefore, the character code for "a" is as follows.

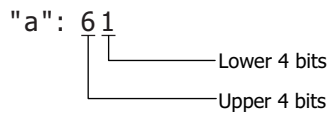

For other fonts and two-byte characters, refer to the table of the relevant code system.

Japanese (two-byte characters): JIS first standard/second standard, Chinese: GB2312, Taiwanese: BIG5, Korean (Hangul character): KSC5601

European Font (ISO 8859-1)

	0	1	2	3	4	5	6	7	8	9	A	B	C	D	E	F
0				0	@	P	`	p				°	À	Ð	à	ä
1			!	1	À	Q	a	q			ı	±	Á	Ñ	á	ñ
2			”	2	B	R	b	r			ø	²	Â	Ò	â	ò
3			#	3	C	S	c	s			£	³	Ã	Ó	ã	ó
4			\$	4	D	T	d	t			¤	´	Ä	Ô	ä	ô
5			%	5	E	U	e	u			¥	µ	Å	Õ	å	õ
6			&	6	F	V	f	v			¦	¶	Æ	Ö	æ	ö
7			'	7	G	W	g	w			§	·	Ç	×	ç	÷
8			(8	H	X	h	x			¨	,	È	Ø	è	ø
9)	9	I	Y	i	y			©	¹	É	Ù	é	ù
A			*	:	J	Z	j	z			ª	º	Ê	Ú	ê	ú
B			+	;	K	[k	{			«	»	Ë	Û	ë	û
C			,	<	L	\	l				¬	¼	Ì	Ü	ì	ü
D			-	=	M]	m	}				½	Í	Ý	í	ý
E			.	>	N	^	n	~			®	¾	Î	Þ	î	þ
F			/	?	O	_	o				¯	¿	Ï	ß	ï	ÿ

Central European Font (ANSI 1250)

	0	1	2	3	4	5	6	7	8	9	A	B	C	D	E	F
0				0	@	P	`	p	€			°	Á	Ð	í	đ
1			!	1	À	Q	a	q		´	˘	±	Á	Ñ	á	ń
2			”	2	B	R	b	r	,	'	˘	˙	Â	Ñ	â	ň
3			#	3	C	S	c	s		“	‡	†	Ã	Ó	ã	ó
4			\$	4	D	T	d	t	„	”	¤	´	Ä	Ô	ä	ô
5			%	5	E	U	e	u	…	•	Ħ	µ	Í	Õ	í	õ
6			&	6	F	V	f	v	†	-	¦	¶	Ć	Ö	ć	ö
7			'	7	G	W	g	w	‡	-	§	·	Ç	×	ç	÷
8			(8	H	X	h	x			¨	,	Č	Ř	č	ř
9)	9	I	Y	i	y	%	™	©	ª	É	Ù	é	ù
A			*	:	J	Z	j	z	Š	š	§	§	Ę	Ú	ę	ú
B			+	;	K	[k	{	<	>	«	»	Ë	Û	ë	û
C			,	<	L	\	l		Ś	ś	¬	ˆ	Ě	Ü	ě	ü
D			-	=	M]	m	}	Ÿ	ť	-	ˆ	Í	Ý	í	ý
E			.	>	N	^	n	~	Ž	ž	®	ˆ	Î	Þ	î	þ
F			/	?	O	_	o		Ž	ž	Ž	ž	Ď	ß	ď	·

Baltic Font (ANSI 1257)

	0	1	2	3	4	5	6	7	8	9	A	B	C	D	E	F
0				0	@	P	`	p	€			°	Ā	Š	ą	š
1			!	1	Ā	Q	a	q		`		±	Ī	Ń	ı	ń
2			”	2	B	R	b	r	,	’	ϕ	²	Ā	Ņ	ā	ņ
3			#	3	C	S	c	s		“	£	³	Ć	Ó	ć	ó
4			\$	4	D	T	d	t	„	”	¤	´	Ä	Ō	ä	ō
5			%	5	E	U	e	u	…	•		μ	Å	Õ	å	õ
6			&	6	F	V	f	v	†	-	ı	¶	Ę	Ö	ę	ö
7			’	7	G	W	g	w	‡	-	§	·	Ē	×	e	÷
8			(8	H	X	h	x			Ø	ø	Č	Ů	č	ů
9)	9	I	Y	i	y	%	™	©	’	É	Ł	é	ł
A			*	:	J	Z	j	z			®	ı	Ž	Ś	ż	ś
B			+	;	K	[k	{	<	>	«	»	É	Ū	é	ū
C			,	<	L	\	l				¬	¼	Ġ	Ū	ğ	ü
D			-	=	M]	m	}	”	-	-	½	Ķ	Ž	ķ	ž
E			.	>	N	^	n	~	˘	˙	©	¾	Ī	Ž	ı	ž
F			/	?	O	_	o		˘	˙	€	æ	Ł	B	ł	·

Cyrillic Font (ANSI 1251)

	0	1	2	3	4	5	6	7	8	9	A	B	C	D	E	F	
0				0	@	P	`	p	б	ђ		°	А	Р	а	р	
1			!	1	А	Q	a	q	ѓ	`	ў	±	Б	С	б	с	
2			”	2	B	R	b	r	,	’	ў	ı	І	В	Т	в	т
3			#	3	C	S	c	s	ѓ	“	Ј	ı	Г	У	г	у	
4			\$	4	D	T	d	t	„	”	¤	ı	Д	Ф	д	ф	
5			%	5	E	U	e	u	…	•	Г	μ	Е	Х	e	x	
6			&	6	F	V	f	v	†	-	ı	¶	Ж	Ц	ж	ц	
7			’	7	G	W	g	w	‡	-	§	·	З	Ч	з	ч	
8			(8	H	X	h	x	€		Ё	ё	И	Ш	и	ш	
9)	9	I	Y	i	y	%	™	©	®	Й	Щ	й	щ	
A			*	:	J	Z	j	z	љ	љ	Є	є	К	ъ	к	ъ	
B			+	;	K	[k	{	<	>	«	»	Л	ъ	л	ъ	
C			,	<	L	\	l		ђ	ђ	¬	ј	М	ъ	м	ъ	
D			-	=	M]	m	}	ќ	ќ	-	ѕ	Н	Э	н	э	
E			.	>	N	^	n	~	ћ	ћ	©	ѕ	О	Ю	о	ю	
F			/	?	O	_	o		џ	џ	İ	ı	П	Я	п	я	

Japanese Font (JIS X0201)

	0	1	2	3	4	5	6	7	8	9	A	B	C	D	E	F
0				0	@	P	`	p				-	タ	ミ		
1			!	1	A	Q	a	q			。	ア	チ	ム		
2			"	2	B	R	b	r			「	イ	ツ	メ		
3			#	3	C	S	c	s			」	ウ	テ	モ		
4			\$	4	D	T	d	t			、	エ	ト	ヤ		
5			%	5	E	U	e	u			・	オ	ナ	ユ		
6			&	6	F	V	f	v			ヲ	カ	ニ	ヨ		
7			'	7	G	W	g	w			ァ	キ	ヌ	ラ		
8			(8	H	X	h	x			イ	ク	ネ	リ		
9)	9	I	Y	i	y			ゥ	ケ	ノ	ル		
A			*	:	J	Z	j	z			エ	コ	ハ	レ		
B			+	;	K	[k	{			オ	サ	ヒ	ロ		
C			,	<	L	¥	l				ャ	シ	フ	ワ		
D			-	=	M]	m	}			ュ	ス	ヘ	ソ		
E			.	>	N	^	n	~			ョ	セ	ホ	ッ		
F			/	?	O	_	o				ッ	ソ	マ	°		

Control Codes

Refer to the following table when using control codes in User Communications.

	0	1	2	3	4	5	6	7	8	9	A	B	C	D	E	F
0	NUL	DEL														
1	SOH	DC1														
2	STX	DC2														
3	ETX	DC3														
4	EOT	DC4														
5	ENQ	NAK														
6	ACK	SYN														
7	BEL	ETB														
8	BS	CAN														
9	HT	EM														
A	LF	SUB														
B	VT	ESC														
C	FF	FS														
D	CR	GS														
E	SO	RS														
F	SI	US														

1.3 Available Number of Colors

The available number of colors that can be used on the WindO/I-NV3 are listed below.

Model	Target	Number of colors
Color LCD models	Picture Manager	65,536 colors
	Properties of Drawings and Parts	256 colors
Monochrome LCD models	Picture Manager	8 shades
	Properties of Drawings and Parts	8 shades

1.4 Available Image Files

- The supported formats for image files displayed on the Touch are BMP (bit map files) and NMF (NV Metafile).
- The NMF (NV Metafile) format is used for the drawing objects created on the editing screen of WindO/I-NV3. Graphics can be created by selecting a drawing object on the editing screen and clicking **Export as NV Metafile** from the popup menu.
- Picture Manager supports WME (Windows Metafile), DXF, and ICO (icon files) formats. These files are converted by Picture Manager into bitmap files.



- The Touch cannot handle image files that are larger than the size of the screen. Images that exceed the screen size are not displayed.
- The Numerical Input, Character Input, Message Display, Message Switching Display, Numerical Display, Calendar, and Meter cannot correctly display pictures that use a transparent color.

● About Picture Manager

Picture Manager is an application for managing graphic elements used for part diagrams and drawings.

- When saving, deleting, or reducing graphic elements, the following operations are displayed in Picture Manager.
 - On the **View** tab, in the **Workspace** group, click  (Picture Manager).
 - Double click **Picture Manager** in the **Project** window.
- To set up the Picture from the Drawings, click on the editing screen where the Picture is positioned to display Picture Manager.
- If setting a graphic for a positioned object, display Picture Manager from the Properties dialog box.



If Picture Manager is displayed from the Properties dialog box of an object on the screen when setting the Picture, **Reduce**, **Delete**, and **Export** are disabled.

● Saving graphic elements in Picture Manager

This section describes how to save drawing objects in Picture Manager. Saved graphic elements can be used for part diagrams and drawings.

Saving image files

- 1 Click **Import** in Picture Manager.

The Open dialog box is displayed.

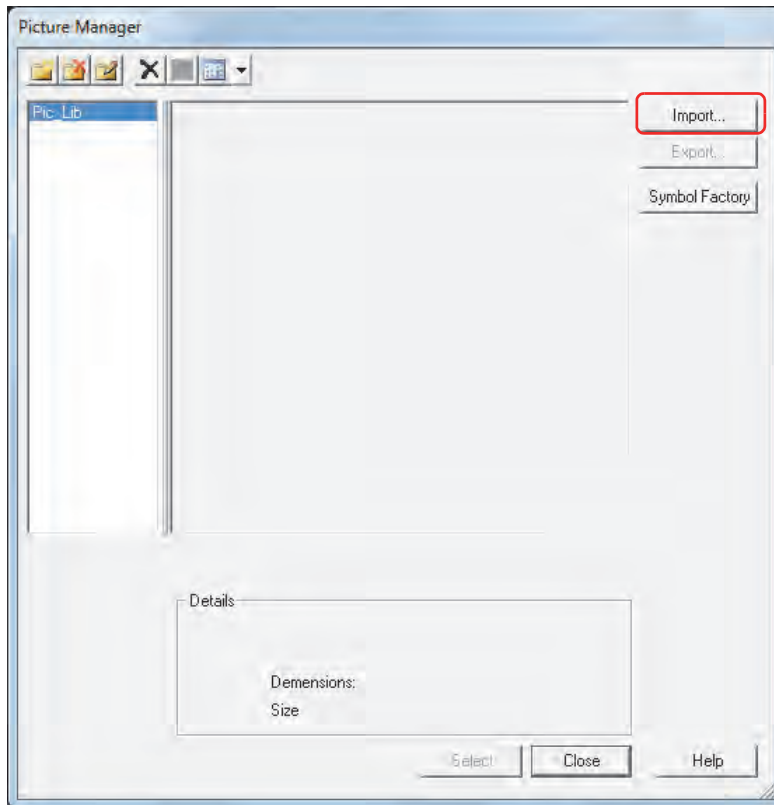

When managing graphic elements by category, click  (Create New Category) to create a new category in the **Category** list, and select it.

- 2 Specify the image file, and then click **Open**.

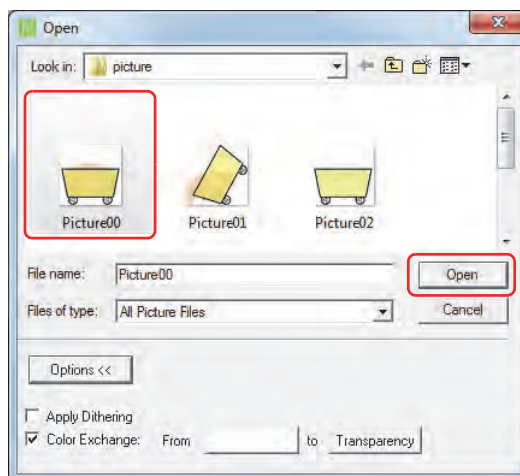

Detailed settings can be made using Options from the Open dialog box. Click **Options** to toggle between showing and hiding the items. For details, refer to “Open Dialog Box Options” on page 2-28.

The graphic element is saved in Picture Manager. The name of the image file becomes the picture name.

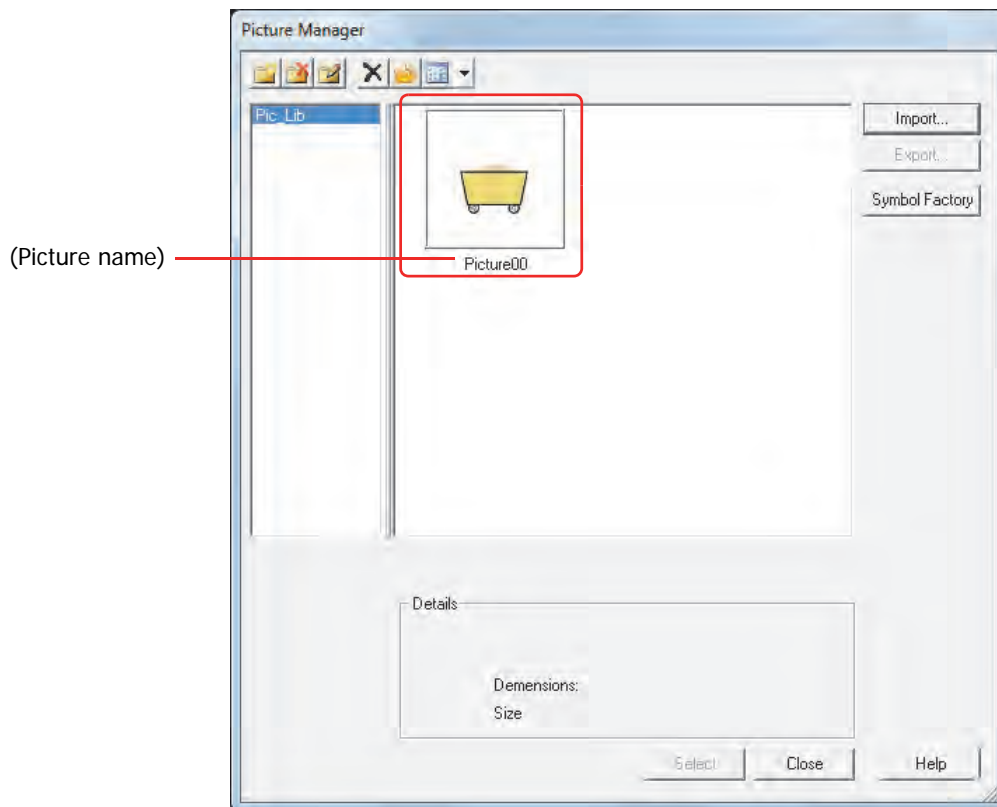

Even when the image is saved to a different category, if a graphic element of the same name is already saved in that category, a confirmation message to overwrite the file is displayed.

- Click **Yes** to overwrite the image.

After overwriting, the image is saved in the list of the selected category, and the previous image is deleted from the list.

Example: The graphic element "Picture00" is saved in the category "Pic_Lib."

If the graphic element "Picture00.bmp" is saved to the category "NewBook1," the new image "Picture00" is saved to "NewBook1," and the image named "Picture00" that was previously in "Pic_Lib" is deleted.

- Click **No** to stop saving the graphic element.

Selecting graphic elements from Symbol Factory

- 1 Click **Symbol Factory** in Picture Manager.
Symbol Factory is displayed.

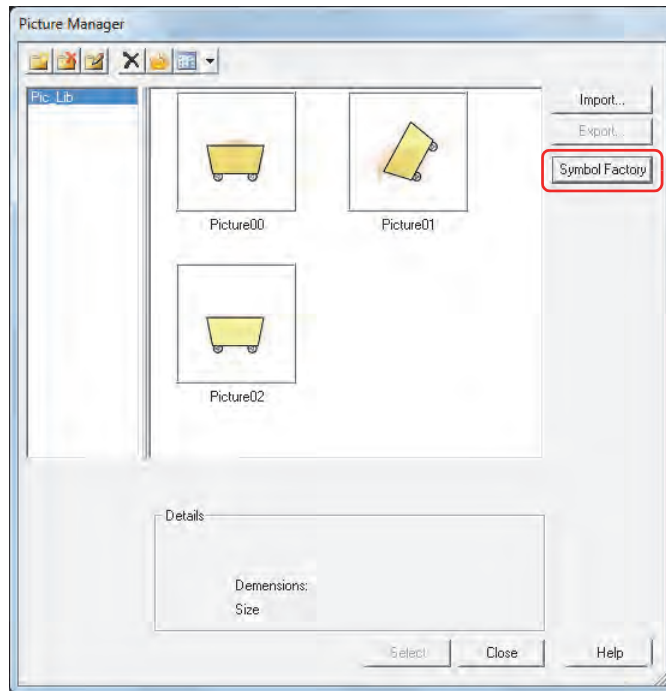

When managing graphic elements by category, click  (Create New Category) to create a new category in the **Category** list, and select it.

- 2 Select a category of graphic elements from **Categories**.
A list showing pictures in the category selected from **Symbols** is displayed.

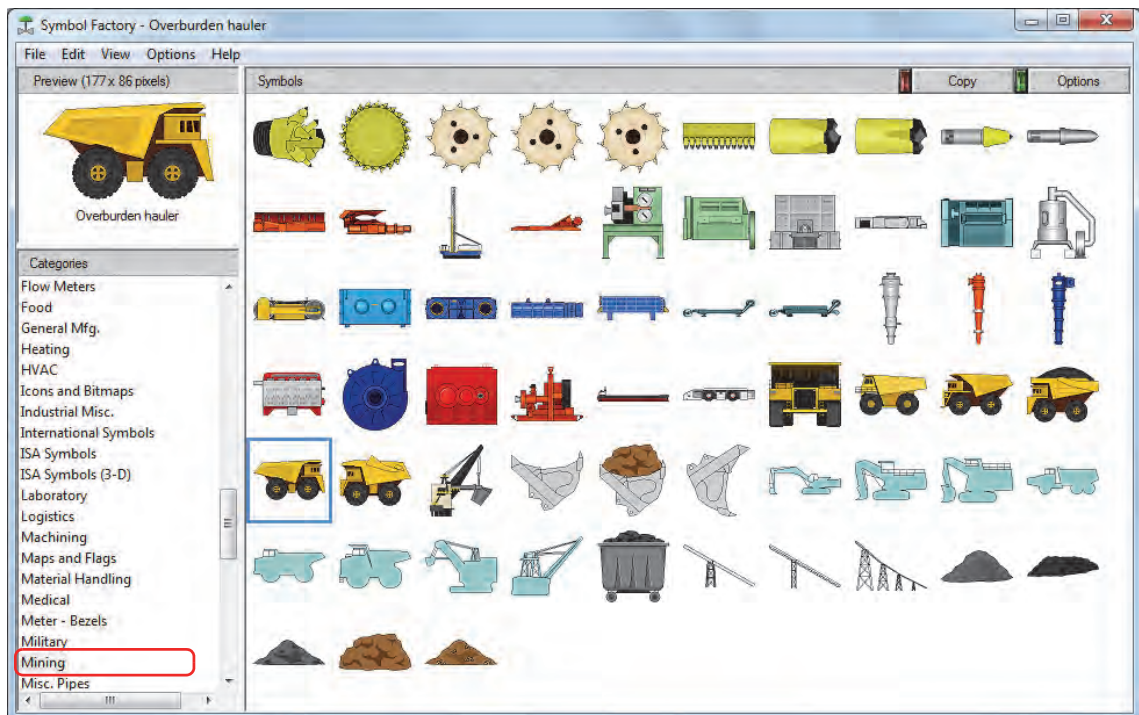

Click **Options** to display the Symbol Options dialog box, which can be used to modify fill color and background color, and to flip or rotate shapes. The settings made here are applied to all the graphic elements in Symbol Factory.

- 3 Select a graphic element from **Symbols**, and then click **Copy**.
The Picture Name Setting dialog box is displayed.
- 4 Enter the name of the graphic in **Picture Name**.
The maximum number is 256 characters.



You cannot use the following characters in the picture name.

\\ / : , ; * ? " < > |

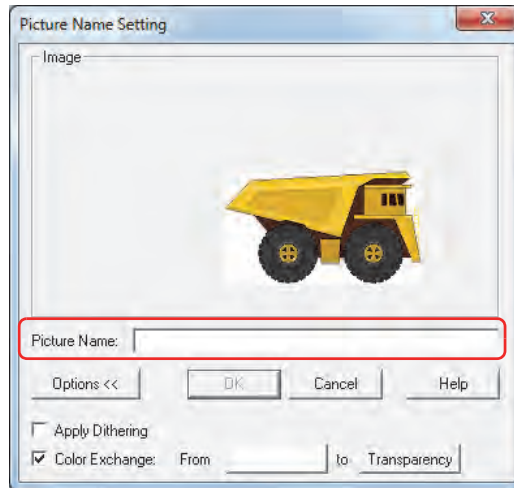

Detailed settings can be made using Options from the Picture Name Setting dialog box. Click **Options** to toggle between showing and hiding the items. For details, refer to "Picture Name Setting dialog box" on page 2-32.

- 5 Click **OK**.
The graphic element is saved in Picture Manager.

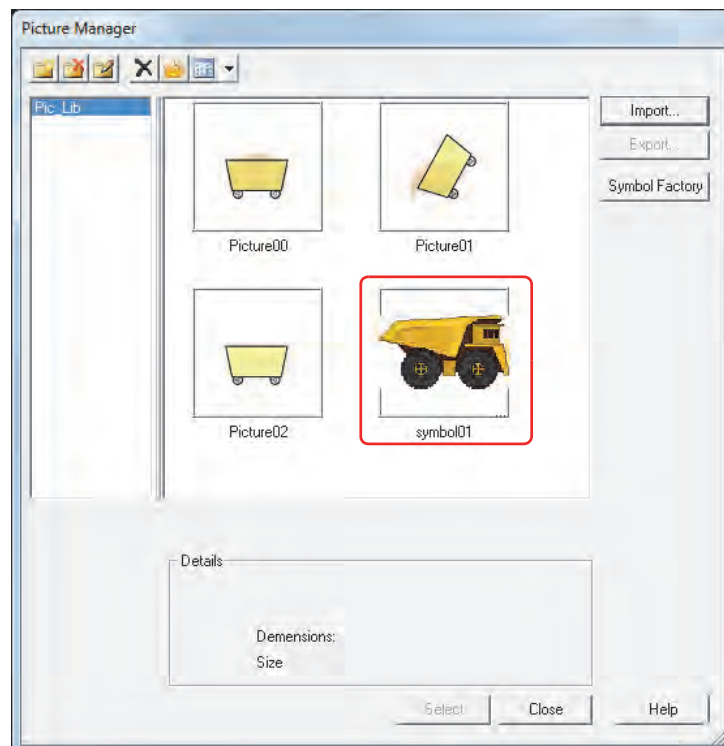

If a picture contains transparency or a picture is imported with the option of enabling the transparency, the transparency range is displayed in magenta (R: 255, G: 4, B: 255).

Saving drawing objects drawn on the editing screen

Drawing objects drawn on the editing screen are saved as pictures, in NMF (NV Metafile) format in Picture Manager.

- 1 Select and right-click the drawing object, then click **Copy to Picture Manager**.

The Picture Name Setting dialog box is displayed.

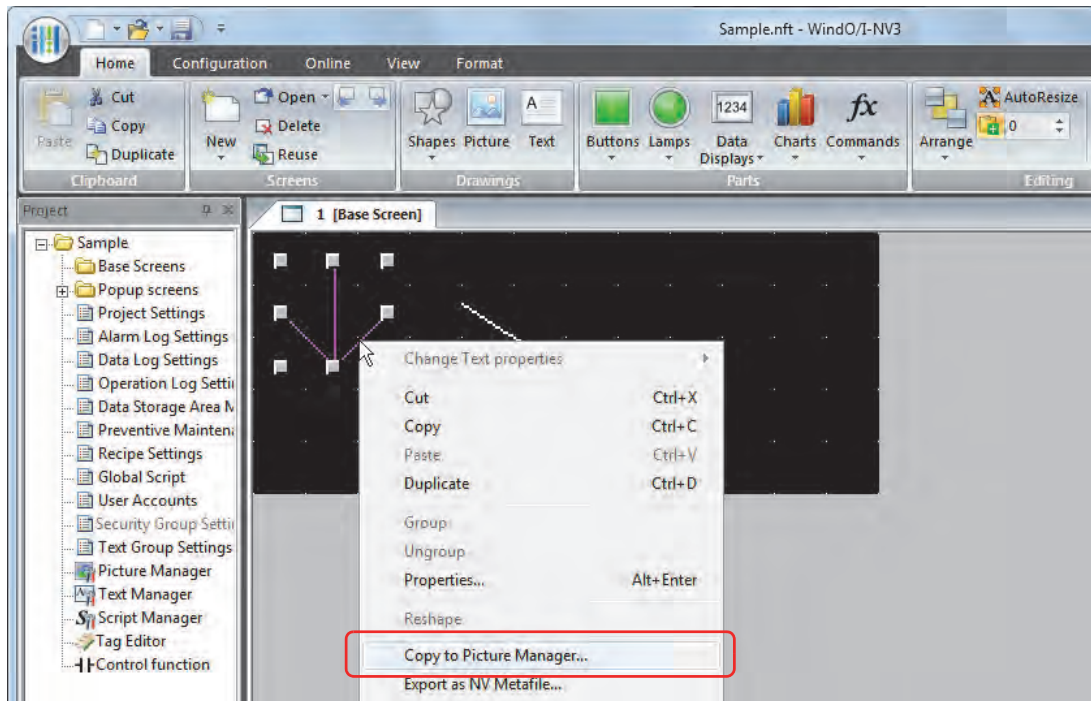

Grouped drawing objects can be saved to Picture Manager as a single picture.

- 2 Enter the name of the drawing object in **Picture Name**.

The maximum number is 256 characters.



You cannot use the following characters in the picture name.

\\ / : , ; * ? " < > |

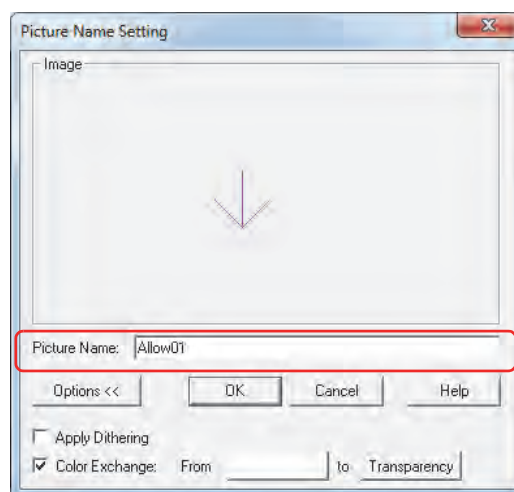

Detailed settings can be made using Options from the Picture Name Setting dialog box. Click **Options** to toggle between showing and hiding the items. For details, refer to "Picture Name Setting dialog box" on page 2-32.

- 3 Click **OK**.
The drawing object is saved in Picture Manager.

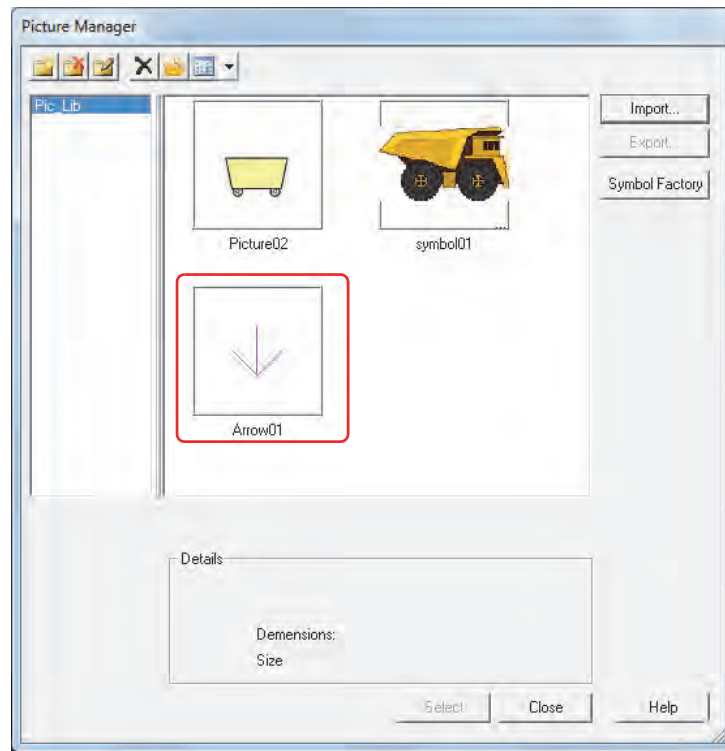

If a picture contains transparency or a picture is imported with the option of enabling the transparency, the transparency range is displayed in magenta (R: 255, G: 4, B: 255).

● Saving pictures as image files

To use a picture saved in Picture Manager on another computer, save the picture as an image file.

1 Select a picture to export, and then click **Export**.

The Save As dialog box is displayed.



When Picture Manager is called from the Properties dialog box of an object arranged on the screen, **Export** is not enabled.



- To select multiple pictures, press and hold SHIFT or CTRL while you click the specific items.
- To save as an image file in NMF (NV Metafile) format, select and right-click the drawing object drawn on the editing screen, then click **Export as NV Metafile**.

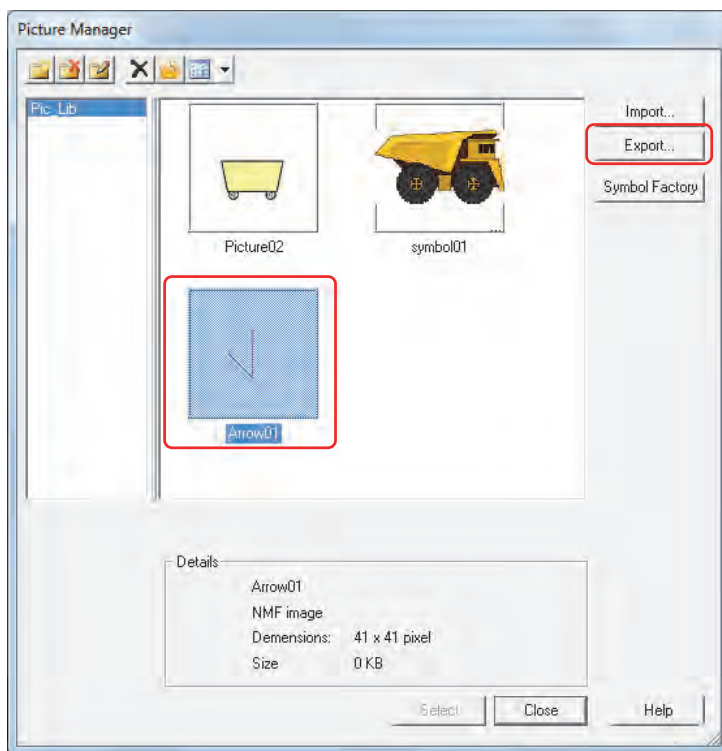

2 Specify the save location in **Save in**, and then click **Save**.

The picture name is entered as **File name**.

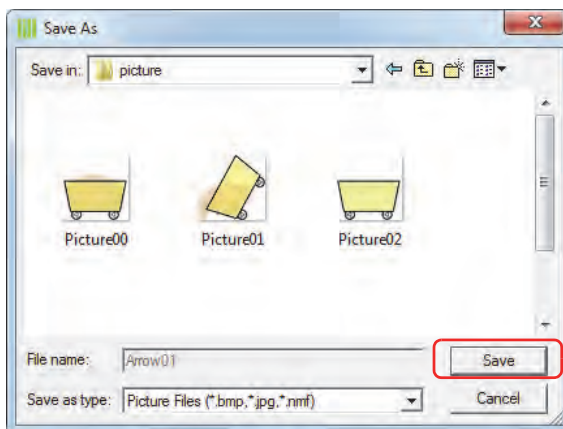

● Managing Pictures

This section describes items and buttons in Picture Manager, Symbol Factory, and the Picture Name Setting dialog box.

Picture Manager

Pictures used in pictures of part diagrams and drawings are managed using Picture Manager.

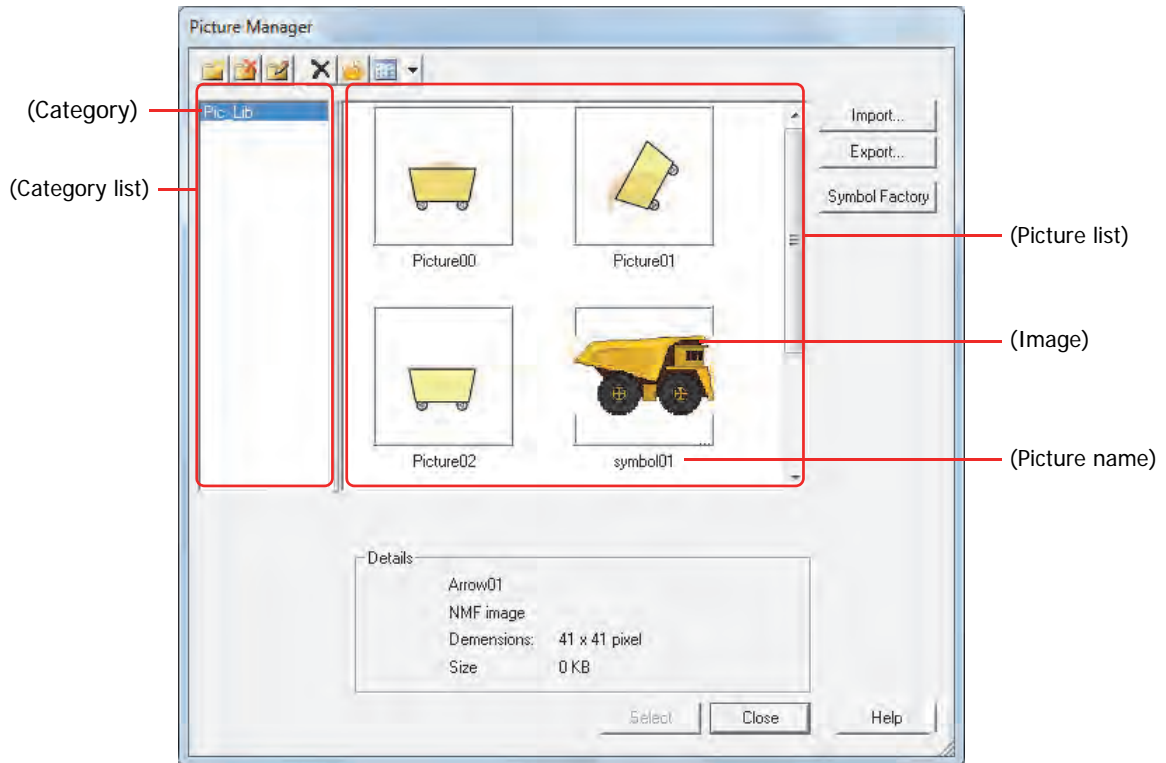

■ (Create New Category)

Creates a new category in the category list.

The default category name is "NewBook n " (n : Number).

■ (Delete Category)

Deletes a category from the category list.

■ (Rename Category)

Changes the name of the category selected in the category list. The maximum number is 256 characters.



You cannot use the following characters in the category name.

\ / : , ; * ? " < > |

■ (Delete)

Deletes the picture selected in the picture list. Pictures that are used in project or parts cannot be deleted.

■ (Reduce)

Deletes all the pictures not used in the project from the pictures saved in the picture list.

■ (View)

Change how items appear in the picture list. Click  to select **Thumbnails** or **Details**.

■ (Category List)

Selects a category to save to when saving pictures.

When selecting a picture, select the category in which the arranged picture is saved.

The only default category is "Pic_Lib." To add a category, click  (Create New Category).

(Category): The name of the category is displayed.

■ (Picture list)

The saved pictures are displayed as a list of images.

(Image): An image of the picture is displayed. If a picture contains transparency or a picture is imported with the option of enabling the transparency, the transparency range is displayed in magenta (R: 255, G: 4, B: 255).

(Picture Name): The name of the picture is displayed.

■ Import

Save pictures in Picture Manager. Click this button to display the Open dialog box. For details, refer to "Saving image files" on page 2-19.

Supported file formats are as follows. When selecting images that are not in a bitmap file format, the image is converted to a bitmap before saving.

- BMP (bitmap file)
- WMF (Windows Metafile)
- DXF and JPEG
- ICO (icon files)
- NMF (NV Metafile)



When saving image files in DXF format, take note of the following points.

- Compatible with AutoCAD Ver. 2.2 to 2002. Compatibility with AutoCAD LT97 is confirmed by IDEC.
- If TrueType fonts are used, there is no garbling of text when Japanese is included in files. SHX format is not supported.
- Errors may occur in conversion of coordinates, resulting in displacement of position. In addition, if an image is greatly reduced when resizing at the time of saving, lines in the picture may disappear.
- If either the height or width is set to 0 when saving, the aspect ratio is preserved with reference to the other dimension.



To save images in NMF format without conversion to bitmap file format, select and right-click the picture on the editing screen, and then click **Copy to Picture Manager** from the popup menu. For details, refer to "Saving drawing objects drawn on the editing screen" on page 2-23.

■ Export

Saves a picture selected in the picture list in BMP (bitmap) or NMF (NV Metafile) format, according to file type. Click this button to display the Save As dialog box. For details, refer to "Saving pictures as image files" on page 2-25.

Saved graphics can be saved using **Import**.

■ Symbol Factory

Display the Symbol Factory images. You can select an image provided by Symbol Factory on your project data. For details, refer to "Symbol Factory" on page 2-29.

■ Advanced

Displays detailed information about pictures selected in the picture list.

(Picture Name): Displays the picture name.

(File Type): Displays the file type.

Image Size (W×H): Displays the size of the picture (W×H) in pixels

File Size: Displays the size of the file (KB).

■ Select

Closes Picture Manager and sets the picture selected in the picture list.

■ Close

Closes Picture Manager.

Open Dialog Box Options

Specify advanced settings when saving image files.

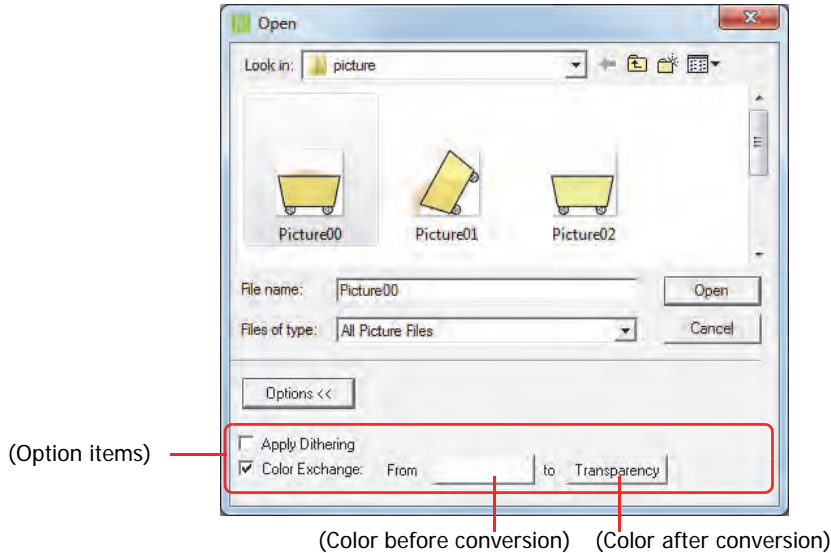

■ Options <<

Toggles between showing and hiding the option items.

■ Apply Dithering

Selects this check box to perform dithering (error diffusion method) on images.

This function enables some images with tonal gradations and photo-like pictures to be rendered more beautifully when they are saved.

■ Color Exchange

Selects this check box to convert the color of the picture.

From: Specifies color before conversion. Click this button to display the Color Settings dialog box. Specify the color, and then click **OK**.

to: Selects the color after conversion (color: 256 colors, monochrome: 8 shades). Click this button to display the Color Palette. Select a color from the Color Palette. **Transparent** can also be selected.



If a color conversion to transparent is done when the monitor used for WindO/I-NV3 is a 16-bit color or 256-color display, even colors other than the color specified in (Color before conversion) may appear transparent. However, on the Touch they will appear normally.

Symbol Factory

Symbol Factory is an English-version library tool that offers 5,000 images.

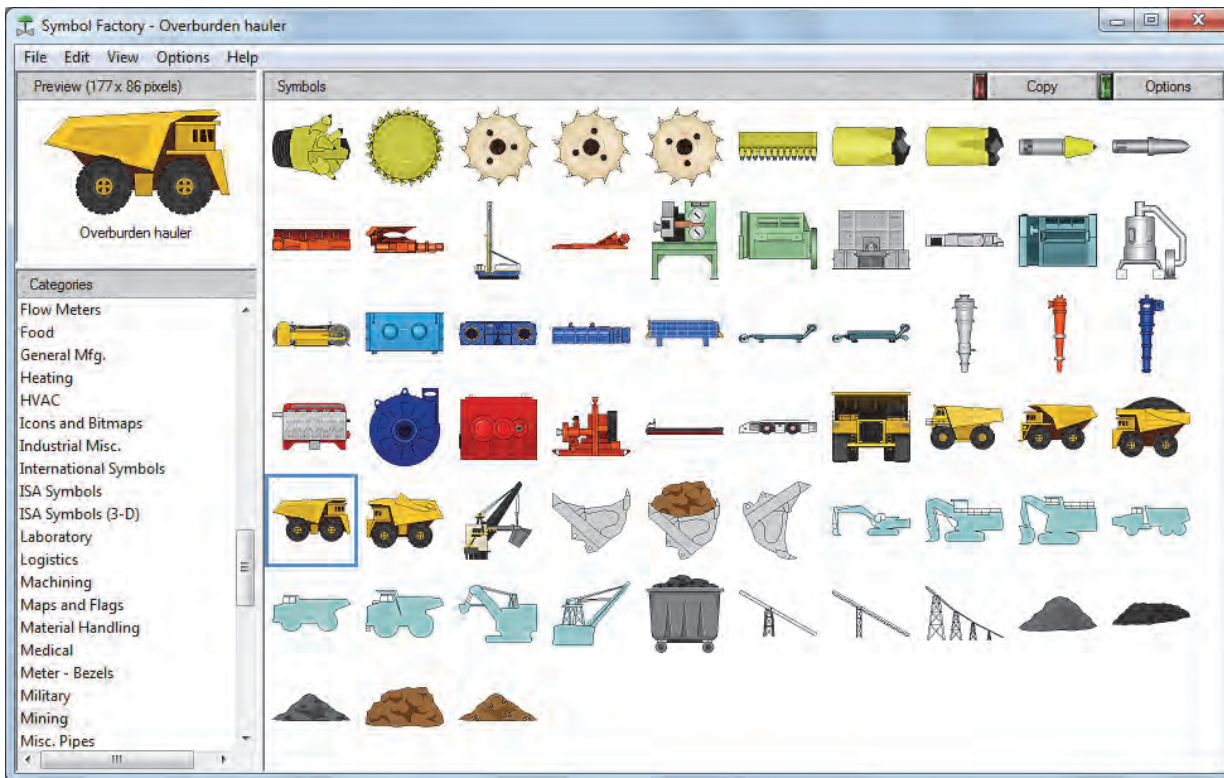

For details, see online help for Symbol Factory.

■ Preview

Image size (W×H in pixels) and preview of the picture are displayed.

■ Categories

The images supplied by Symbol Factory are divided into categories. Selects categories of pictures saved in Picture Manager.

■ Symbols

The pictures in the selected category are displayed in a list. Selects a picture saved in Picture Manager.

■ Copy

Copy a picture selected from the **Symbols** to Picture Manager. Click this button to display the Picture Name Setting dialog box.

■ Options

Modify the fill and background color and flip or rotate shapes. Click this button to display the Symbol Options dialog box.

Symbol Options Dialog Box

Modify the fill color and background color, and to flip or rotate shapes. The settings made here are applied to all the graphic elements in Symbol Factory.

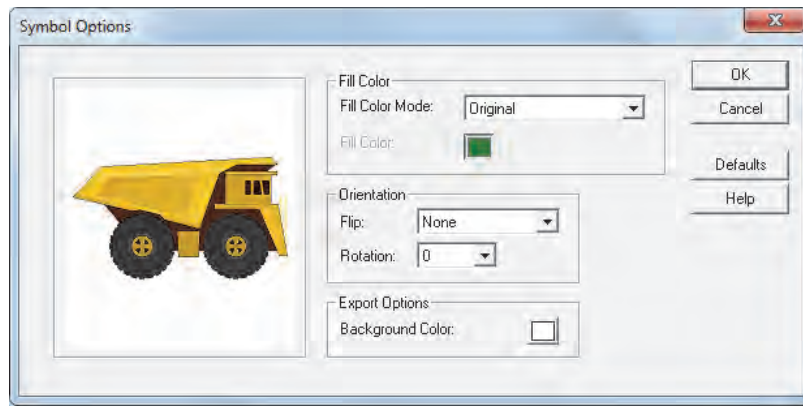

■ Fill Color

Fill Color Mode: Select from the following picture color conversion methods.

Original: The color of the image is not changed.

Shaded: The image filled with different shades of the color selected in **Fill Color** (for a 3D effect).

Solid: The image is filled uniformly in the color selected in **Fill Color**.

Hollow: All color is deleted.

Fill Color: Selects the color used for **Shaded** or **Solid** modes. Click this button to display the Color Settings dialog box. Select a color from the Color Palette.

This option can only be set when **Shaded** or **Solid** are selected as the **Fill Color Mode**.

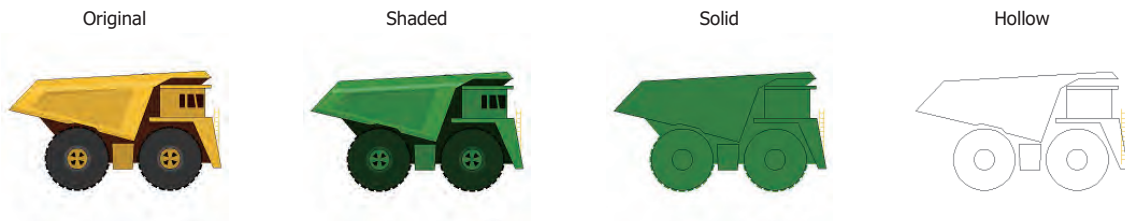

■ Orientation

Flip: Select from the following flipping methods.

None: The image is not flipped.

Horizontal: The image is flipped horizontally.

Vertical: The image is flipped vertically.

Both: The image is flipped both horizontally and vertically.

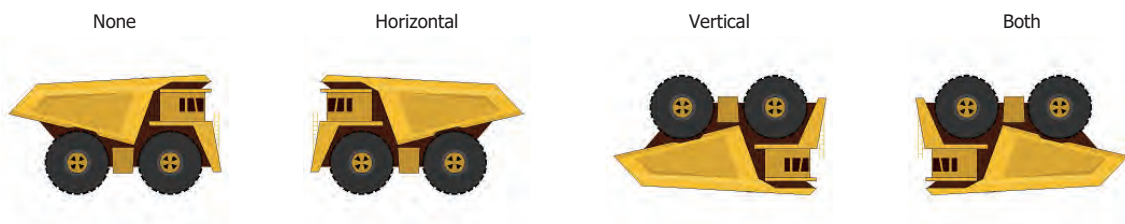

Rotation: Select from the following rotation methods.

- 0: The image is not rotated.
- 90: The image is rotated 90° counterclockwise.
- 180: The image is rotated 180° counterclockwise.
- 270: The image is rotated 270° counterclockwise.

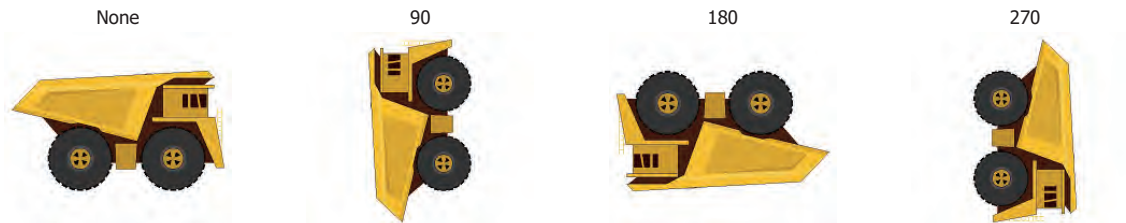

■ Background Color

Selects the background color of the image when saving an image in Picture Manager or exporting an image using **Export Symbol** from the **File** menu. Click this button to display the Color Settings dialog box. Select a color from the Color Palette.



When exporting an image in VML or SVG format by clicking **Export Symbol** from the **File** menu, this setting is not applied.

■ OK

Saves the setting to close the Symbol Options dialog box.

■ Cancel

Closes the Symbol Options dialog box without saving the setting.

■ Defaults

Set options are returned to their default values.

Picture Name Setting dialog box

Specifies a name for images saved in Picture Manager.

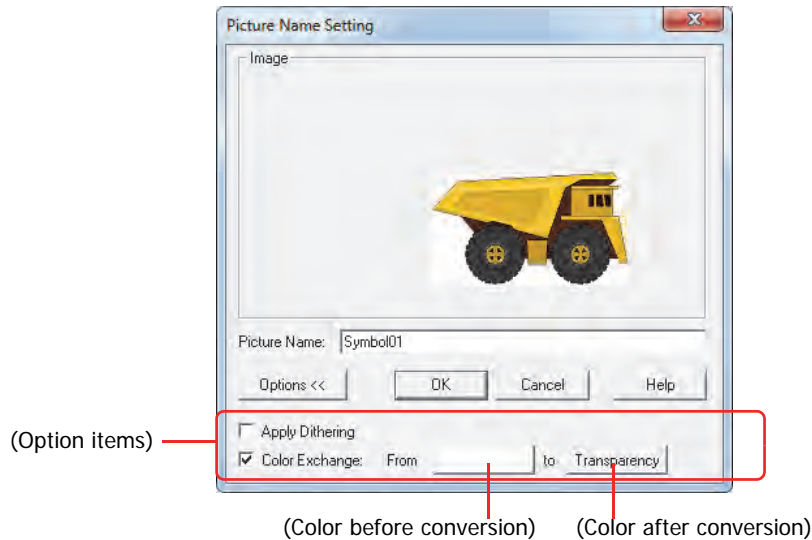

■ Image

An image of the picture is displayed.

■ Picture name

Enter a name for the picture. The maximum number is 256 characters.



You cannot use the following characters in the picture name.

\ / : , ; * ? " < > |

■ Options <<

Toggles between showing and hiding the option items.

■ OK

Saves the image in Picture Manager.

■ Cancel

Stops saving the image.

■ Apply Dithering

Select this check box to perform dithering (error diffusion method) on images.

This function enables some images with tonal gradations and photo-like pictures to be rendered more beautifully when they are saved.

■ Color Exchange

Select this check box to convert the color of the picture.

From: Specifies color before conversion. Click this button to display the Color Settings dialog box. Specify the color, and then click **OK**.

to: Selects the color after conversion (color: 256 colors, monochrome: 8 shades). Click this button to display the Color Palette. Select a color from the Color Palette. **Transparent** can also be selected.



- To make the background color of the picture saved from Symbol Factory transparent, set (Color Before Conversion) and **Background Color** in the Symbol Options dialog box to R: 254, G: 254, B: 254.
- When the monitor used for WindO/I-NV3 is a 16-bit color or 256-color display, there is a risk that one or more of the following phenomena occurs.
 - When a color conversion to transparent is done, even colors other than the color specified in (Color Before Conversion) may appear transparent. However, on the Touch they will appear normally.
 - If converting a background color in Symbol Factory, an image that is copied to the clipboard may have its colors reduced to the number of colors displayed by the computer monitor. For this reason, the color setting will not match and the color conversion will not be performed. Save the image again after changing the background color to another color in Symbol Factory. For example, if the default color (R: 254, G: 254, B: 254) in (Color before conversion) is used, and **Background Color** in Symbol Options dialog box is set to R: 254, G: 254, B: 254, the number of monitor colors will match, even if it's 256, so the color conversion will be performed.

2 Starting and Exiting WindO/I-NV3

2.1 Starting WindO/I-NV3

- **Windows 10**

Click **Start**, click **All Apps**, click **IDEC Automation Organizer**, and then click **WindOI-NV3**.

- **Windows 8**

Click **WindOI-NV3** in the tiles on the Start screen.

- **Windows 7**

Click **Start**, click **Programs**, click **IDEC Automation Organizer**, and then click **WindOI-NV3**.

WindO/I-NV3 starts.



You can also start WindO/I-NV3 by double-clicking the WindO/I-NV3 icon on the desktop.

- Automation Organizer Updater dialog box

The Automation Organizer Updater dialog box is a feature that keeps WindO/I-NV3 up to date.

If a new version of Automation Organizer is released, the Automation Organizer Updater dialog box is displayed when WindO/I-NV3 starts.

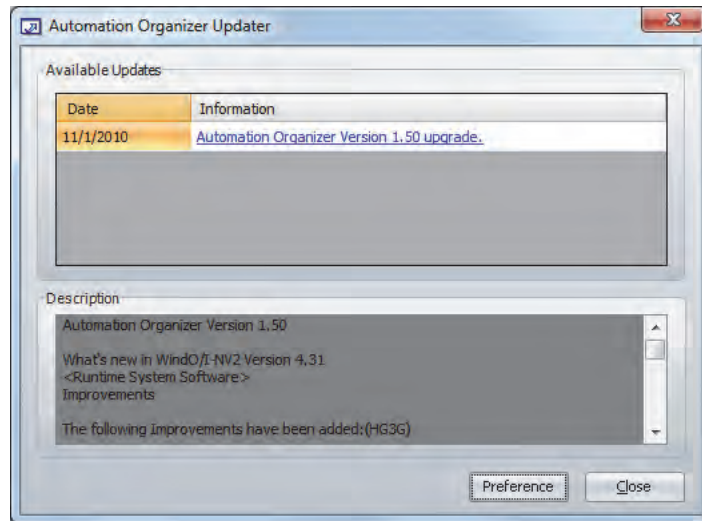

In order to display the Automation Organizer Updater dialog box, your computer must be connected to the Internet.

- Available Updates

Date: Shows the date the software was released.

Information: Shows the software's title and version.

Click on this link to connect to IDEC's download site.

The software can be updated by downloading and running the latest version.

- Description

This area shows the details of the latest changes in the software.

- Preference

The Update Preference dialog box is displayed when this button is clicked.

To update information when WindO/I-NV3 starts, check this check box.

The Automation Organizer Updater dialog box will be displayed when there is an update.

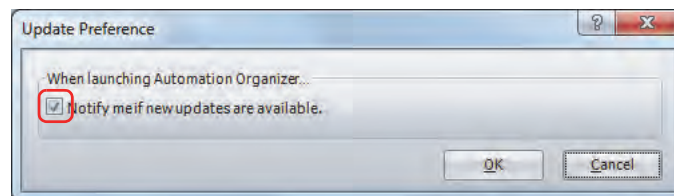

- Close

Closes the Automation Organizer Updater dialog box and start WindO/I-NV3.

- Project Recovery dialog box

The Project Recovery dialog box is a feature to restore edited project data if your computer crashes while you were editing. With this feature, you can return crashed the project to its last-saved state and restore project data that was being edited. The Project Recovery dialog box is displayed if there is crashed project data when WindO/I-NV3 starts.

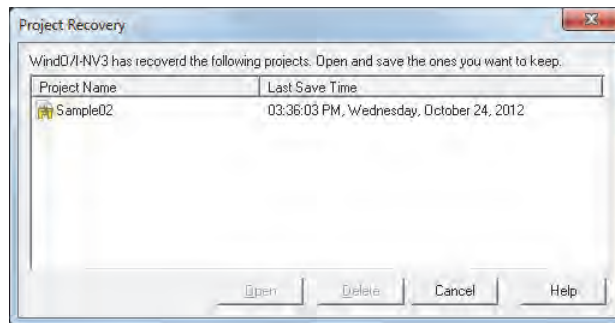

- **(Recovery data list)**

This list shows recoverable data for a crashed project.

Project Name: Shows the project name.

Last Save Time: Shows the date and time when the data was last saved.

- **Open**

Select the recovery data from the list, and then click this button to open the project data. The recovery data is deleted when the project data is saved.

- **Delete**

Deletes the recovery data.

- **Cancel**

Closes the Project Recovery dialog box.

Recovery data is not deleted. The Project Recovery dialog box will be displayed again the next time WindO/I-NV3 starts.



If WindO/I-NV3 crashes in a state where you edit a screen and perform **Save Screens** after saving the project data, the screen is not saved in the project data. Select the recovery data with the Project Recovery dialog box and recover the project data.

2.2 Exiting WindO/I-NV3

Click  and then click **Exit WindO/I-NV3**.

WindO/I-NV3 ends.

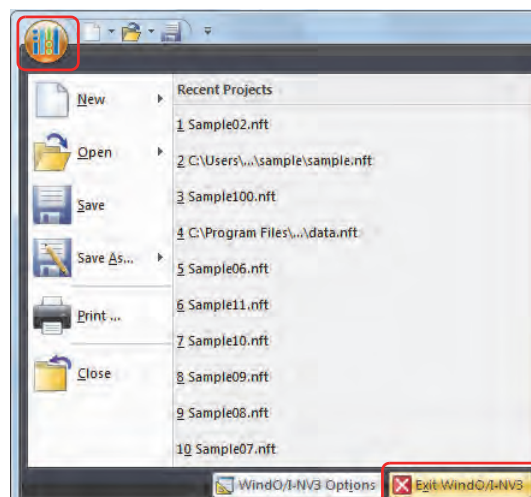

3 Configuration & Functions

This section describes the names and functions that make up WindO/I-NV3.

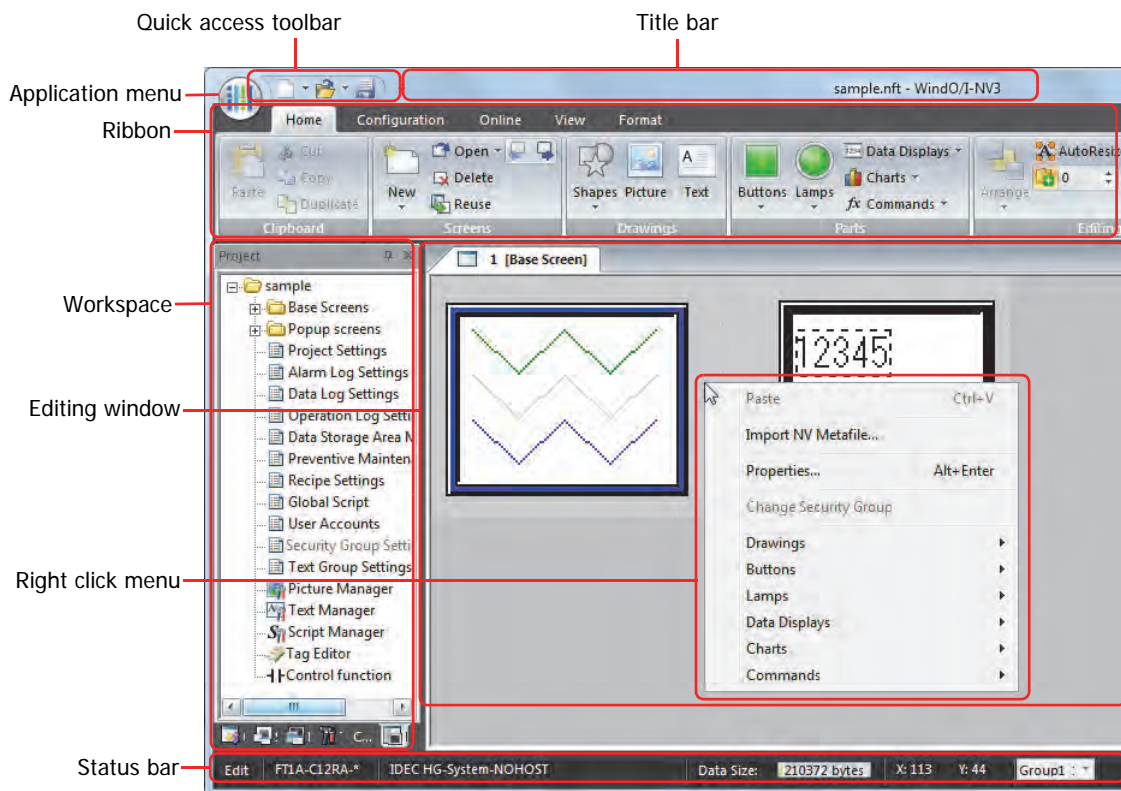

■ Title bar

The title bar shows the name of the project being edited and the name of this software, "WindO/I-NV3".

■ Application menu

The application menu displays commands for handling project data such as commands for creating new project data, opening project data, and saving project data. For details, refer to "3.1 Application Menu Command List" on page 2-37.

■ Quick access toolbar

The quick access toolbar is an area where you can locate commands that you use frequently. You can customize this toolbar by adding or deleting buttons. For details, refer to "3.2 Quick Access Toolbar" on page 2-38.

■ Ribbon

The ribbon shows commands for creating project data and transferring data to the Touch. Common commands are separated into their own tabs, so you can quickly execute. For details, refer to "3.3 Ribbon Command List" on page 2-41.

■ Workspace

The workspace is the area where the **Project** window, the **Object List** window, the **Screen List** window, the **Part List** window, and the **Toolbox** window are located. You can change the position and method for displaying windows in the workspace. For details, refer to "3.4 Windows Displayed in the Workspace" on page 2-49.

■ Editing window

The editing window is the area for editing Base Screens, Popup Screens, and Library Screens.

■ Right click menu

The right click menu is a popup menu that is displayed when right clicking the mouse on drawing objects and parts in a list. It displays context sensitive commands.

■ Status bar

The status bar shows information such as the type number, communication driver, project data size, and cursor position. You can change the items displayed on the status bar. For details, refer to "3.5 Status Bar" on page 2-53.

3.1 Application Menu Command List

Commands that can be executed from the application button are listed below.

Command		Description
New	Interactive Quick Start	Creates project data by configuring settings displayed in dialog boxes step by step.
	From Templates	Creates project data using templates provided with WindO/I-NV3.
Open	WindO/I-NV3 Project	Opens project data that has already been created.
	Other Formats	Opens project data uploaded from a Touch with Downloader and project data saved in the Downloader format.
Save		Saves the project data being edited.
Save As	WindO/I-NV3 Project	Saves the project data being edited with a new name.
	Other Formats	Converts the project data being edited to data that can be used with Downloader and saves it.
Print		Prints the contents of the project data being edited.
Close		Closes the project data being edited.
Recent Projects		Shows the list of recently used project data, up to a maximum of ten items.
WindO/I-NV3 Options		Customizes WindO/I-NV3 and configures the work environment.
Exit WindO/I-NV3		Exits WindO/I-NV3.

3.2 Quick Access Toolbar

● Quick access toolbar buttons and menus

Click on a quick access toolbar button or click on ▼ to the right of a button and then click on the displayed command to execute that command.

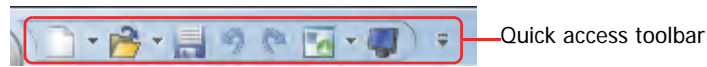

● Customizing the quick access toolbar

If you click the ▼ (Customize Quick Access Toolbar) button, the Customize Quick Access Toolbar menu is displayed. You can change the quick access toolbar to any desired settings.

■ Changing the buttons displayed on the quick access toolbar

Select only the buttons you want to display on the quick access toolbar.

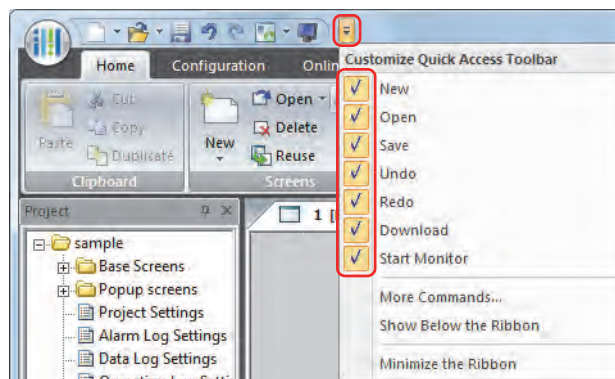

■ More Commands

You can add or delete quick access toolbar commands.

- 1 Click ▼ on the quick access toolbar and then click **More Commands**.

The Customize dialog box is displayed.

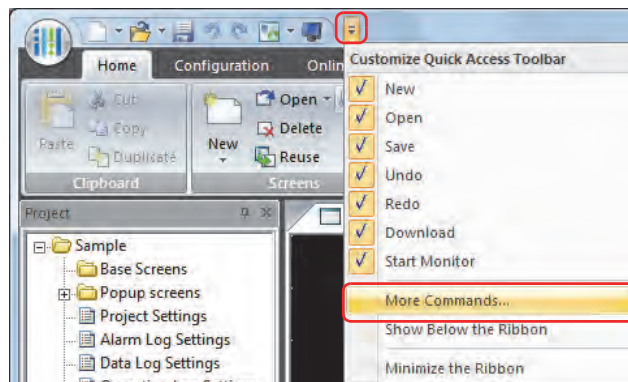

2 Add or delete commands.

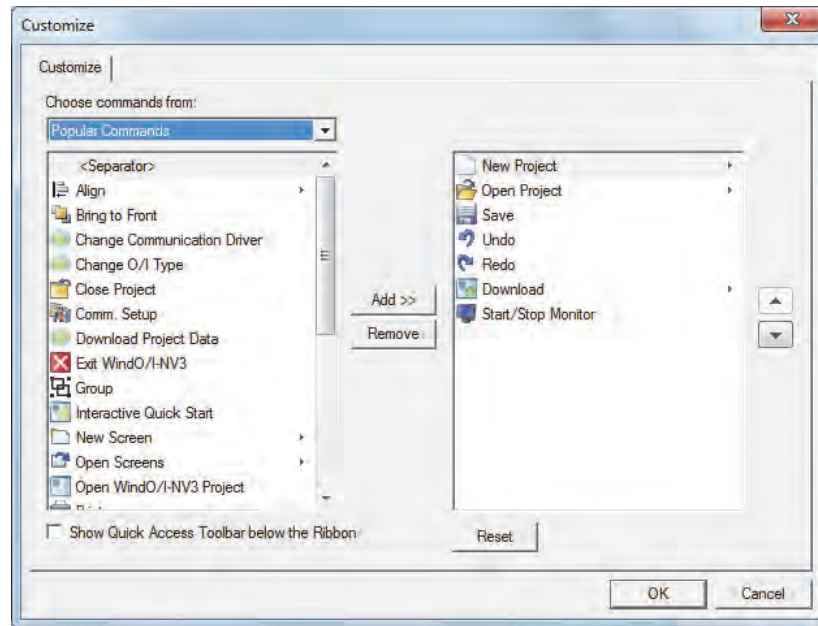

To add a command

- 1 Select the command to add in **Choose commands from**.
- 2 Click on the command to add from the list and then click **Add >>**.
The command is added.

To delete a command

Click the command to delete and then click **Remove**.

The command is deleted.



If you right click a command on the quick access toolbar and click **Remove from Quick Access Toolbar**, that quick access toolbar command can be deleted.



- To change the order of the commands, click a command and then click ▲ or ▼ .
- To return to the quick access toolbar to its default settings, click **Reset**.

■ Show Below the Ribbon

You can change the position of the quick access toolbar to be located below the ribbon.

Click  on the quick access toolbar and then click **Show Below the Ribbon**.

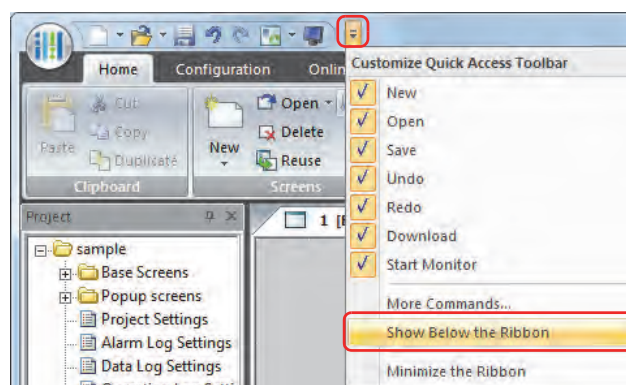

The quick access toolbar moves below the ribbon.

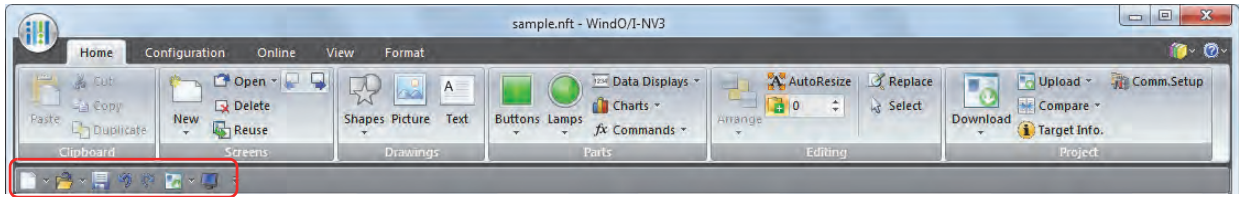

You can also change the quick access toolbar display position to be below the ribbon with the following methods.

- Right click the quick access toolbar or the ribbon and then click **Show Quick Access Toolbar Below the Ribbon**.
- Select the **Show Quick Access Toolbar below the Ribbon** check box on the Customize dialog box.

To return the quick access toolbar to its original position, click , and then click **Show Above the Ribbon**.



You can also return the quick access toolbar to its original position with the following methods.

- Right click the quick access toolbar or the ribbon and then click **Show Quick Access Toolbar Above the Ribbon**.
- Select the **Show Quick Access Toolbar below the Ribbon** check box on the Customize dialog box.

■ Minimize the Ribbon

You can change the format of the ribbon to be displayed only as tabs.

Click  on the quick access toolbar and then check **Minimize the Ribbon**.

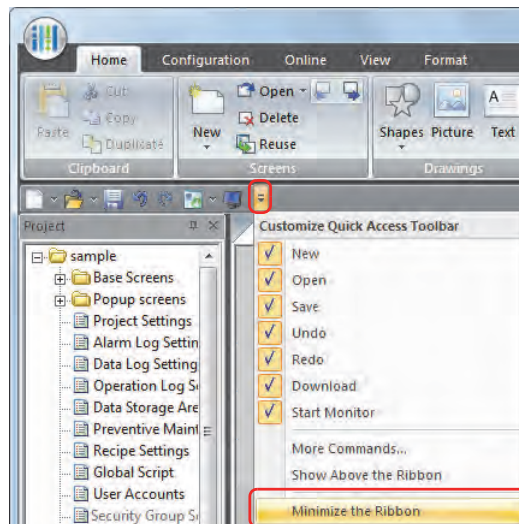

The ribbon is displayed as only tabs.

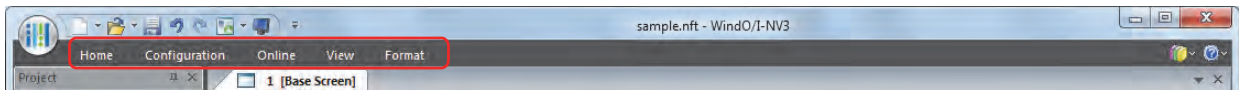

Click on a tab to display its commands.

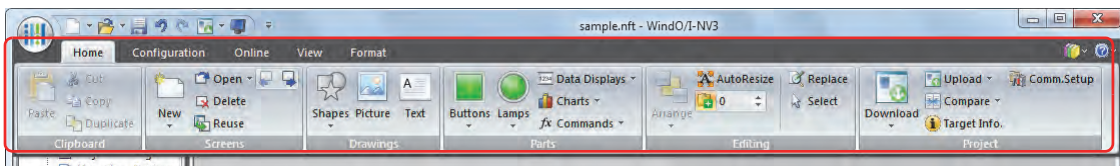

To return the ribbon to its original state, click , and then click on the **Minimize the Ribbon** to remove the check mark.



You can also change the ribbon to be displayed as only tabs with the following methods.

- Right click the quick access toolbar or the ribbon and then click **Minimize the Ribbon**.
- Double click a tab.

3.3 Ribbon Command List

● Home

Home is where basic operations are performed such as creating a new screen, editing, and downloading project data.

■ Clipboard

Command	Description
Paste	Pastes the contents of the clipboard.
Cut	Cuts the selected object from the editing window and copies it to the clipboard.
Copy	Copies the selected object to the clipboard.
Duplicate	Duplicates the selected object.

■ Screens

Command	Description	
New	Base Screen	Adds a new Base Screen.
	Popup Screen	Adds a new Popup Screen.
	Library Screen	Creates a new Library Screen.
Open	Base Screen	Opens a Base Screen that has already been created.
	Popup Screen	Opens a Popup Screen that has already been created.
	Library Screen	Opens a Library Screen that has already been created.
Open Previous Screen	Opens a screen number before the currently selected screen.	
Open Next Screen	Opens a screen number after the currently selected screen.	
Delete	Deletes the selected screen.	
Reuse	Copies another project's screens.	

■ Drawings

Command	Description	
Shapes	Line	Draws a line.
	Polyline	Draws a polyline.
	Polygon	Draws a polygon.
	Rectangle	Draws a rectangle.
	Circle/Ellipse	Draws a circle or ellipse.
	Arc	Draws an arc.
	Pie	Draws a pie.
	Equilateral Polygons	Draws equilateral polygons (equilateral triangle, equilateral diamond, equilateral pentagon, equilateral hexagon, equilateral octagon).
Fill	Fills the region with the same color as the fill start point with the specified color and pattern.	
Picture	Inserts a picture.	
Text	Inserts text.	

■ Parts

	Command	Description
Buttons	Bit Button	Inserts a Bit Button.
	Word Button	Inserts a Word Button.
	Goto Screen Button	Inserts a Goto Screen Button.
	Key Button	Inserts a Key Button.
	Multi-Button	Inserts a Multi-Button.
	Keypad	Inserts a Keypad.
	Selector Switch	Inserts a Selector Switch.
	Potentiometer	Inserts a Potentiometer.
Lamps	Pilot Lamp	Inserts a Pilot Lamp.
	Multi-State Lamp	Inserts a Multi-State Lamp.
Data Displays	Numerical Input	Inserts a Numerical Input.
	Character Input	Inserts a Character Input.
	Picture Display	Inserts a Picture Display.
	Message Display	Inserts a Message Display.
	Message Switching Display	Inserts a Message Switching Display.
	Alarm List Display	Inserts an Alarm List Display.
	Alarm Log Display	Inserts an Alarm Log Display.
	Numerical Display	Inserts a Numerical Display.
	Calendar	Inserts a Calendar.
Charts	Bar Chart	Inserts a Bar Chart.
	Line Chart	Inserts a Line Chart.
	Pie Chart	Inserts a Pie Chart.
	Meter	Inserts a Meter.
Commands	Bit Write Command	Inserts a Bit Write Command.
	Word Write Command	Inserts a Word Write Command.
	Goto Screen Command	Inserts a Goto Screen Command.
	Script Command	Inserts a Script Command.
	Multi-Command	Inserts a Multi-Command.
	Timer	Inserts a Timer.

■ Editing

Command		Description	
Arrange	Bring to Front	Moves the selected object to the front.	
	Send to Back	Moves the selected object to the back.	
	Group	Groups multiple objects.	
	Ungroup	Cancels the group.	
	Align	Align Left	Aligns selected objects to the left.
		Align Center	Aligns selected objects to the center.
		Align Right	Aligns selected objects to the right.
		Align Top	Aligns selected objects to the top.
		Align Middle	Aligns selected objects to the middle.
		Align Bottom	Aligns selected objects to the bottom.
		Make Horizontal Spacing Equal	Aligns selected objects to be equally spaced horizontally.
	Make Vertical Spacing Equal	Aligns selected objects to be equally spaced vertically.	
	Rotate	Rotate Right 90°	Rotates selected drawing objects 90° to the right.
		Rotate Left 90°	Rotates selected drawing objects 90° to the left.
Flip Vertical		Flips selected drawing objects vertically.	
Flip Horizontal		Flips selected drawing objects horizontally.	
Replace	Automatically replaces a specified device address with a separate device address.		
Select	Selects objects in the editing window.		
AutoResize	Automatically changes the text size to the object's size and display region.		
Increment Address	Enables or disables the increment address function. A specific value is added to the value of the object's device address when pasting and duplicating parts.		

■ Project

Command		Description
Download	Project Data	Downloads project data to the Touch.
	Files to External Memory	Stops the Touch and then downloads Recipe files (CSV file) to the external memory inserted in the Touch. The Touch resumes running when files have finished downloading.
	Files to External Memory while running	Downloads Recipe files (CSV file) to the external memory inserted in the Touch without stopping it.
Upload	Project Data	Uploads project data from the Touch.
	Stored Data in External Memory	Uploads data from the External Memory Folder for the currently running project.
Compare	Compare Projects	Compares the screen data and scripts in an existing project with the project data currently being edited and displays the results of that comparison.
	Re-verify	Updates the comparison results to the most latest state.
Target Info.	Displays version information for the Touch runtime system and project information.	
Comm.Setup	Configures the communication target and communication conditions between the target and the Touch or between the computer and the Touch.	

● Configuration

Configuration is where you configure the system settings for the Touch that will use the project data being edited.

■ System Setup

Command	Description
Project	Configures Touch operations and functions.
Alarm Log	Configures the alarm log.
Data Log	Configures the data log.
Operation Log	Configures the operation log.
Data Storage Area	Changes the allocation of the data storage area.
Preventive Maintenance	Configures the preventative maintenance function.
Recipe	Configures recipes.
Text Group	Configures text groups.
Global Script	Configures one global script.

■ Protect

Command	Description
User Accounts	Configures security function, user accounts, and passwords.

● Online

Online is where you download created project data and files to the Touch, where you upload data from the Touch, and where you perform monitoring.

■ Transfer

Command		Description
Download	Project Data	Downloads project data to the Touch.
	Files to External Memory	Stops the Touch and then downloads Recipe files (CSV file) to the external memory inserted in the Touch. The Touch resumes running when files have finished downloading.
	Files to External Memory while running	Downloads Recipe files (CSV file) to the external memory inserted in the Touch without stopping it.
Upload	Project Data	Uploads project data from the Touch.
	Stored Data in External Memory	Uploads data from the External Memory Folder for the currently running project.

■ Touch

Command		Description
Target Info.		Displays version information for the Touch runtime system and project information.
Clear	All	Clears all of the data stored in the internal memory on the Touch.
	Alarm Log Data	Clears all of the alarm log data stored in the internal memory on the Touch.
	Data Log Data	Clears all of the data log data stored in the internal memory on the Touch.
	Operation Log Data	Clears all of the operation log data stored in the internal memory on the Touch.
	Data of all Device Addresses	Clears the data of all device addresses.
	Stored Data in External Memory	Clears data saved to the external memory inserted in the Touch.
Format		Formats the external memory inserted in the Touch.

■ Monitors

Command		Description
Start/Stop Monitor		Connects the Touch to the external device and starts monitoring. This command also stops monitoring.
Screens		Shows or hides the Screen Monitor window.
Object List		Displays a value of device in a popup and emphasizes the object that is satisfying the trigger condition in the object list or script editor.
Custom		Shows or hides the Custom Monitor window.
Batch		Shows or hides the Batch Monitor window.
External Devices		Shows or hides the External Device Monitor window during 1:N communication.
Back		Returns to the Base Screen that was displayed immediately before the screen was changed.
Forward		Advances to the Base Screen that was displayed immediately before the screen was changed with the Back command.
Go to Screen	First Screen	Switches to the Base Screen with the smallest screen number in the project data.
	Previous Screen	Switches to the Base Screen with a screen number one smaller than the Base Screen currently displayed. If the screen numbers are not consecutive numbers, this command switches to the closest number.
	Screen Number	Switches to the Base Screen with a specified number.
	Next Screen	Switches to the Base Screen with a screen number one larger than the Base Screen currently displayed. If the screen numbers are not consecutive numbers, this command switches to the closest number.
	Last Screen	Switches to the Base Screen with the largest screen number in the project data.
Open Current Screens		Opens a monitored screen in the editing window.

■ Communication

Command		Description
Setup		Configures the communication target and communication conditions between the target and the Touch or between the computer and the Touch.

- View

View is where you can switch the workspace display and display the Tag Editor, Screen Diagram, and various managers. You can configure the items displayed in the editing window.

- **Workspace**

Command	Description
Toolbox	Shows the Toolbox window. This window displays Parts and Drawings.
Project Window	Shows the Project window. This window displays the saved screens and project related information.
Screen List	Shows the Screen List window. The window displays the screens saved in the project as thumbnails.
Object List	Shows the Object List window. This window displays all of the graphics and parts placed in an editing screen.
Part List	Shows the Part List window. This window displays the list of part images.
Tag Editor	Shows the Tag Editor. This window displays the list of registered device address, tag name, and comments.
Screen Diagram	Shows the Screen Diagram. This window displays the Overlapping Screen information, and the screen numbers and titles of the screens linked by the Goto Screen Button, the Goto Screen Command, the Numerical Input, the Character Input, the Alarm List Display and the Alarm Log Display.
Comparison Result	Shows the Comparison Result window. This window displays the results of that comparison of projects.
Picture Manager	Shows Picture Manager. Manages the registered images for project use.
Text Manager	Shows Text Manager. Manages registered text which can be used for Text, Part objects, title of Popup Screen, messages with Alarm List Display and Alarm Log Display.
Script Manager	Shows Script Manager. Manages registered scripts for project use.
Protocol Manager	Shows Protocol Manager. Manages protocols created.
Control Function	Start up WindLDR. This is an editor for performing various control function settings and creating ladder programs or FBD programs.

- **Show/Hide**

Command	Description	
Part Name	Shows or hides drawing object names and part names.	
Device Address	Shows or hides device addresses and tag names.	
Trigger Condition	Shows or hides trigger conditions.	
Commands	Shows or hides the dotted frame for commands.	
Popup Screen	Shows or hides a Popup Screen's number, display frame, and the part name of the part calling that Popup Screen.	
Overlay Screens	Shows or hides the configured overlay screens.	
Security Group	Display	Shows or hides the display security group set for parts.
	Input	Shows or hides the input security group set for parts.
Gridlines	Shows or hides the gridlines in the editing window.	

■ Screens

Command		Description
Focus Order		Changes the order to move the focus with Numerical Input and Character Input.
State	Reset	Returns the displayed images to the default images.
	ON/OFF State	Switches between the ON image and the OFF image for buttons and lamps.
	Previous State	Changes the image for the displayed part to the previous state.
	State Number	Changes the image for the displayed part to the image for the part with the specified number.
	Next State	Changes the image for the displayed part to the next state.
	Text Group	Changes the displayed text to the text of the specified text group.
	Active User	Displays only the parts that correspond to the specified user.

■ Zoom

Command	Description
Zoom	Changes the magnification of the editing window.

■ Window

Command	Description
Close All	Closes all editing windows.

● Format

Format is where you change the style of drawing objects, arrange objects, and change their size.

■ Shape Style

Command	Description
1 dot	Sets the line width to one dot.
2 dots	Sets the line width to two dots.
3 dots	Sets the line width to three dots.
5 dots	Sets the line width to five dots.
Solid	Sets the line to solid.
Dot	Sets the line to dotted.
Dash	Sets the line to dashes.
Long Dash	Sets the line to long dashes.
Long Dash Dot	Sets the line to long dash dot.
Long Dash Dot Dot	Sets the line to long dash dot dot.
Pattern	Changes the pattern.
Foreground Color	Changes the pattern's foreground color.
Background Color	Changes the pattern's background color.

■ Text Style

Command	Description
Regular	Sets the text style to regular.
Bold	Sets the text style to bold.
Shadow	Gives the text a shadow.
Text Color	Changes the text color.
Text Background Color	Displays the text as if it were highlighted with a highlighter.
Shadow Color	Changes the color of the shadow added to text given a shadow.

■ Arrange

Command	Description
X-coordinate	Changes the X-coordinate of the selected object.
Y-coordinate	Changes the Y-coordinate of the selected object.
Bring to Front	Moves selected object to the front.
Send to Back	Moves selected object to the back.
Group	Groups selected objects so they can be handled as a single object.
Ungroup	Restores a grouped object to its individual objects.
Rotate Right 90°	Rotates selected objects right 90°.
Rotate Left 90°	Rotates selected objects left 90°.
Flip Vertical	Vertically flips selected objects.
Flip Horizontal	Horizontally flips selected objects.
Align Left	Aligns selected objects to the left.
Align Center	Aligns selected objects to the center.
Align Right	Aligns selected objects to the right.
Align Top	Aligns selected objects to the top.
Align Middle	Aligns selected objects to the middle.
Align Bottom	Aligns selected objects to the bottom.
Make Horizontal Spacing Equal	Arranges selected objects to be equally spaced horizontally.
Make Vertical Spacing Equal	Arranges selected objects to be equally spaced vertically.

■ Size

Command	Description
Width	Changes the width of the selected object.
Height	Changes the height of the selected object.
Make Same Width	Makes the selected objects a uniform width.
Make Same Height	Makes the selected objects a uniform height.

3.4 Windows Displayed in the Workspace

- Changing the position of windows

Disabling docking

You can change the display position of the window by dragging and dropping the title bar of the window or its tab to disable docking. Windows that are not docked are called floating windows.

- If you drag the title bar of the workspace window, you can move all the docked windows together.

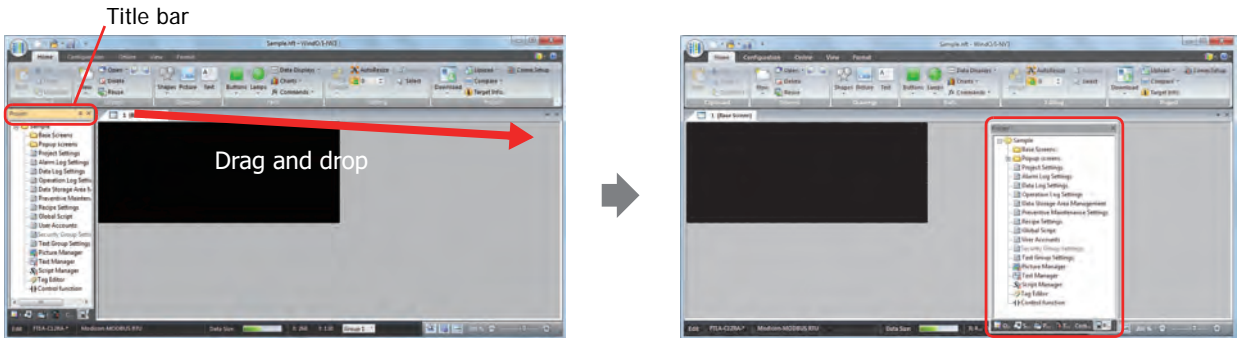

- If you drag the tab of a workspace window, you can move just the selected window.

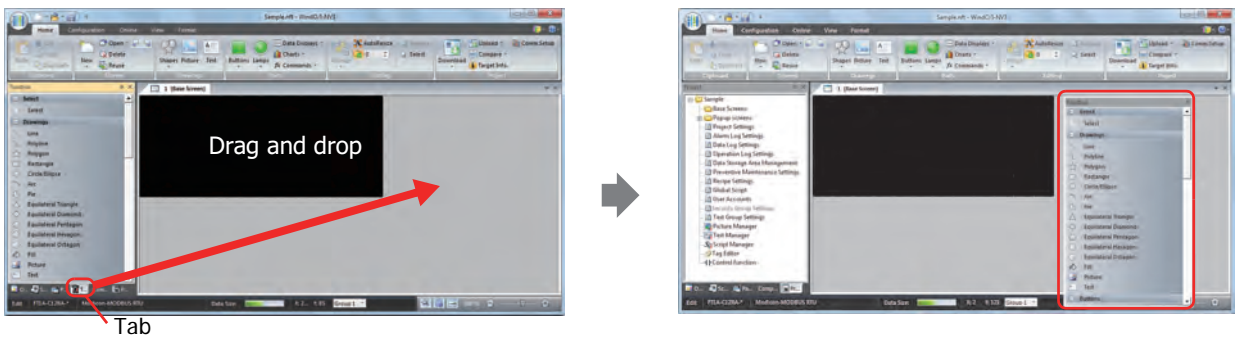

Docking windows



You can dock a floating window to WindO/I-NV3's left, right, top, or bottom frame or a separate window.

- 1 Drag the window's title bar or tab.

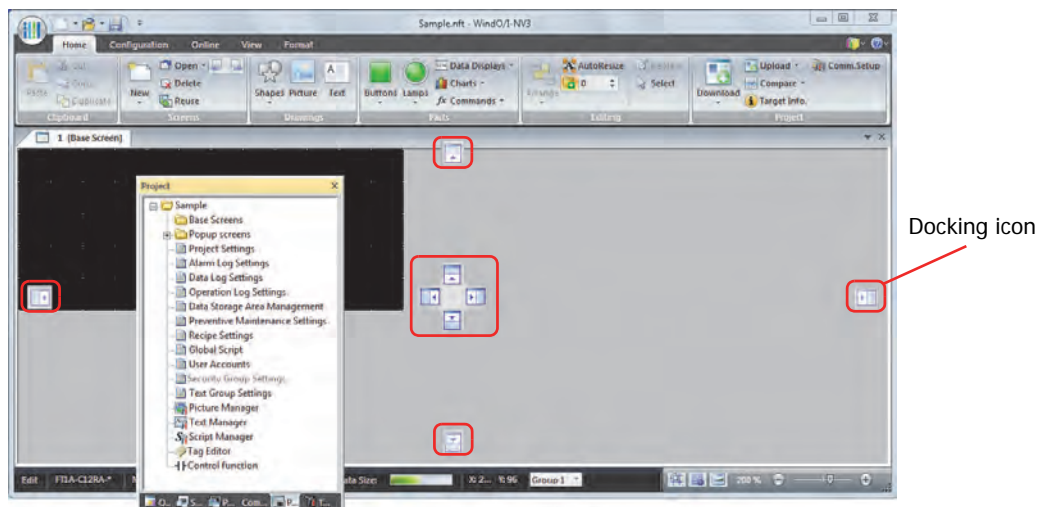
The  (Docking) icon is displayed.





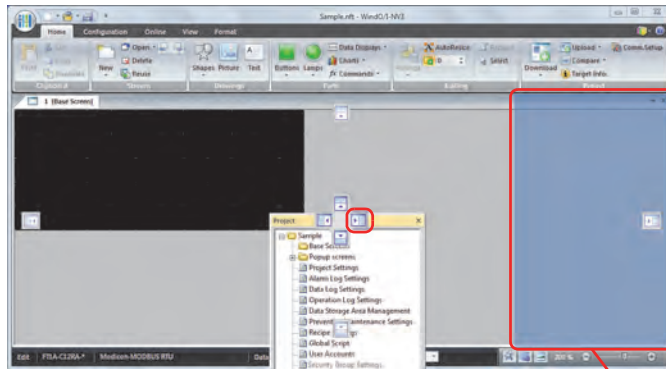

When the mouse cursor gets close to a  (Docking) icon while dragging the title bar or tab, the  (Docking) icon turns blue and the location to dock the window is displayed.



Window docking location

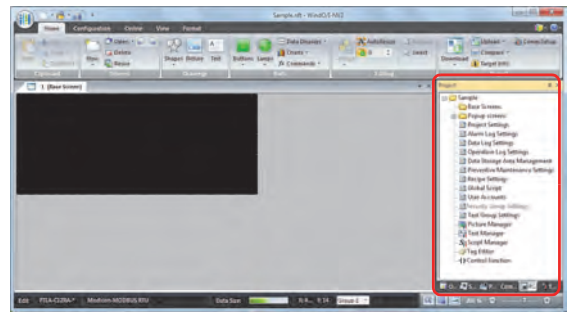
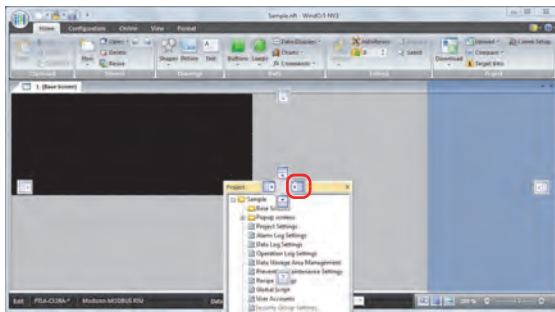

2 Drop the title bar or tab on the  (Docking) icon to dock that window to WindO/I-NV3's left, right, top, or bottom frame or a separate window.

- If the workspace window is dropped on the  (Docking) icon, it is docked to WindO/I-NV3's left, right, top, or bottom frame.

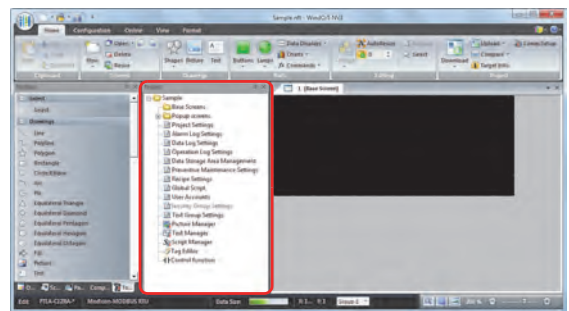
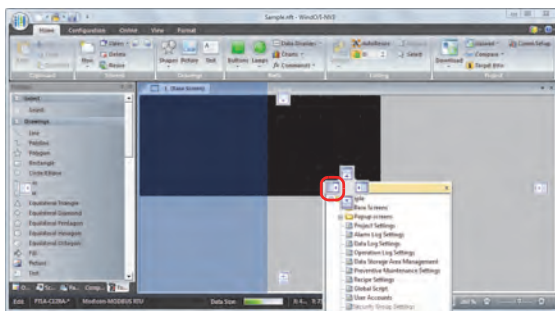

- If a floating window is dropped on the  (Docking) icon, it is docked to WindO/I-NV3's left, right, top, or bottom frame or a docked window.



- If you put the mouse cursor on another window while dragging a floating windows title bar, the  (Docking) icon is displayed. Drop the title bar on the  (Docking) icon to dock the floating window to that window. Change the displayed window with the tabs.

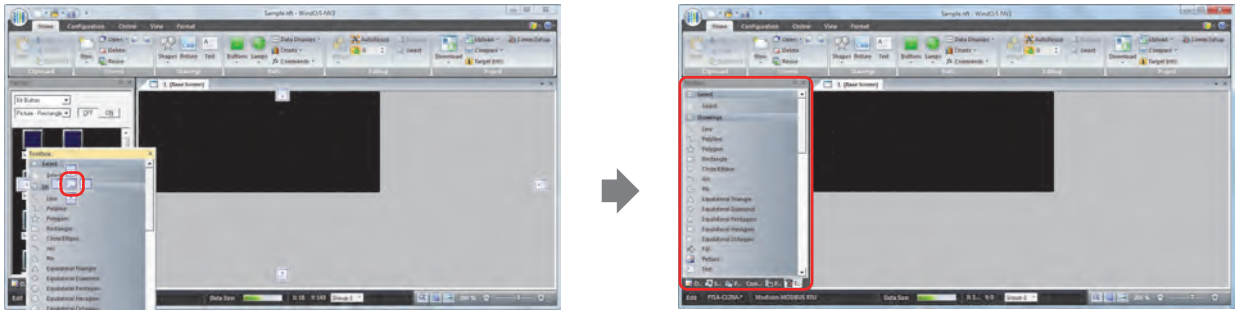

● Changing the display method of windows

Auto Hide

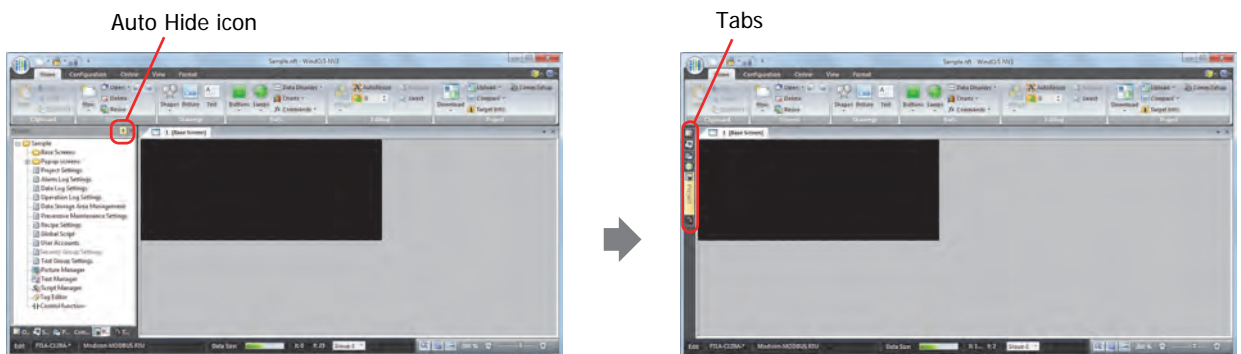

If the workspace window is docked, you can change the window to automatically hide and show only its tabs.

Click the  (Auto Hide) icon to change the window to show only its tabs.

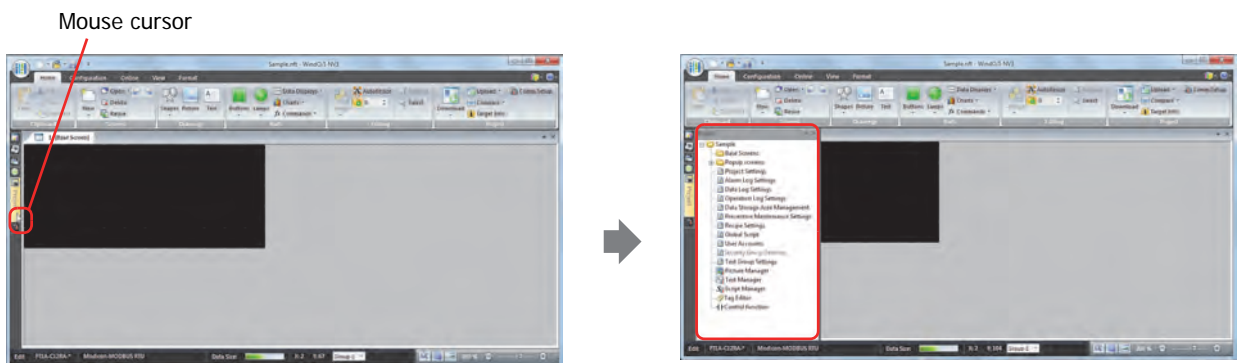

The window is displayed when you bring the mouse cursor close to the tabs.





- Click  (Auto Hide) to secure the window in place.
- Click  (Close) to close the window.

The editing windows are displayed side by side.

When multiple editing windows are open, you can display those windows side by side.

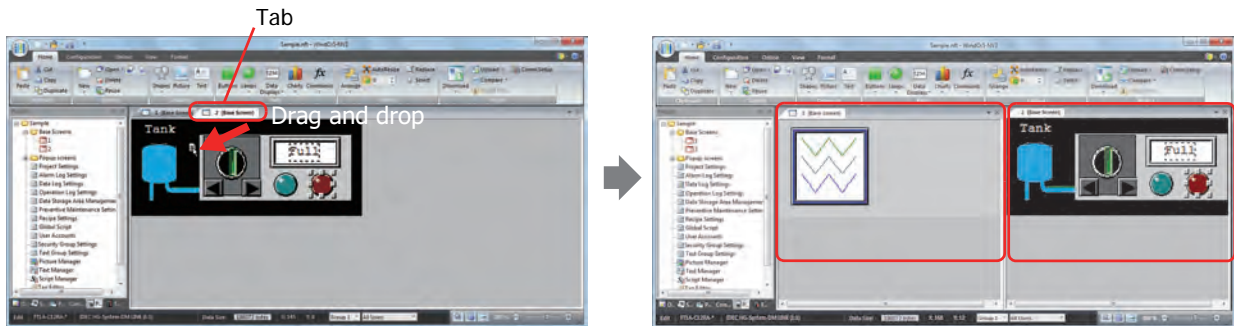
Drag the tab of the editing window to display side by side and drop it where the  icon is displayed. The editing windows are displayed side by side.



- You can change the active editing windows by clicking on  or  (Active Files) and selecting the editing window.

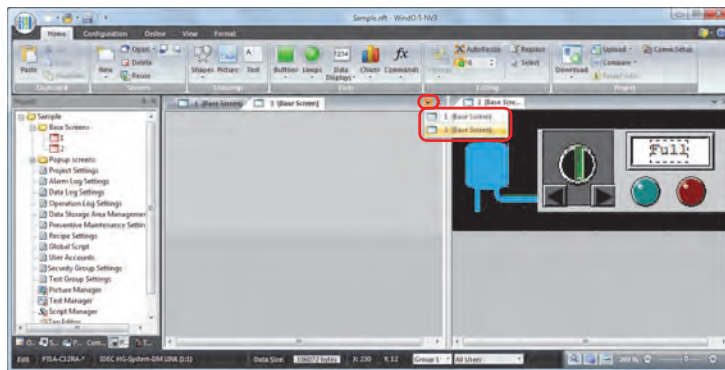

- Click  (Close) to close the active editing window.

3.5 Status Bar

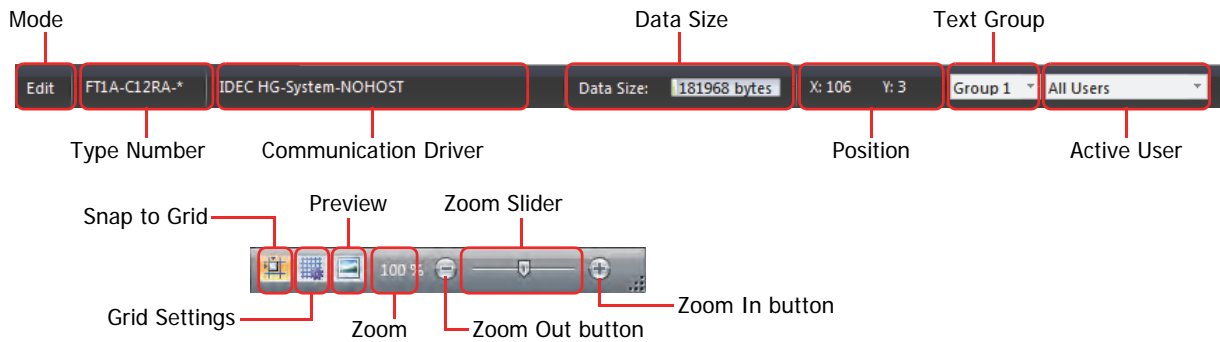

● Status bar items

■ Mode

This section of the status bar shows WindO/I-NV3's current mode.

■ Type Number

This section of the status bar shows the Touch type set in the project data being edited.

■ Communication Driver

This section of the status bar shows the communication driver set in the project data being edited.

■ Data Size

This section of the status bar shows the download data file size for the project data being edited.

When you save the project, the display is updated with the latest information.

■ Position

This section of the status bar shows the X- and Y-coordinates of the mouse cursor in the editing window.

■ Text Group

This section of the status bar shows the current text group. The text displayed in the editing window changes according to the displayed text group.

To change the text group, click ▼ and select the text group.

■ Active User

This section of the status bar shows the active user. You can hide or show objects in the editing window according to the security group of the displayed user.

To change the active user, click ▼ and select the user.

■ Snap to Grid

Click  to align objects to the grid.

■ Grid Settings

You can change the style and spacing of the grid displayed in the editing window.

Click  to display the Grid Settings dialog box. Configure the items, and then click **OK**.

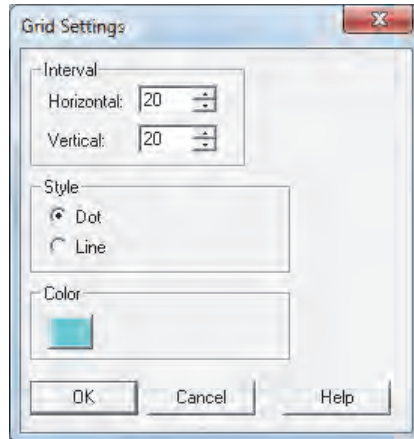

Interval: Aligns the gridlines to the specified spacing.
Enter the spacing for the gridlines in **Horizontal** and **Vertical**.

Style: Select the grid style with **Dot** or **Line**.

Color: Select the grid color.
Click this button to open the color palette. Select the color with the color palette.

■ Preview

You can preview an edited screen.

Click  to open the preview window.

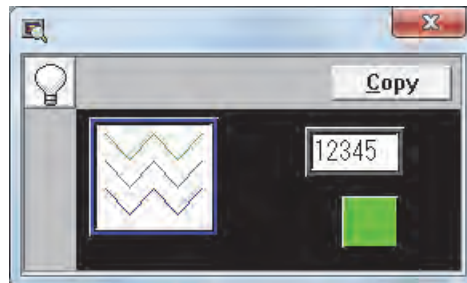

 (ON/OFF): Click the button to switch between the OFF image and ON image for buttons and lamps.

Copy: You can save the image displayed in the preview window as a bitmap image file by clicking **Copy**.



The preview display and the actual screen displayed on the Touch may differ.

For example, the image for overlay screens in the preview display is always shown in front. However, when drawings and parts overlap on the actual screen, parts are always shown in front irregardless of the order of overlay screens.

■ Zoom

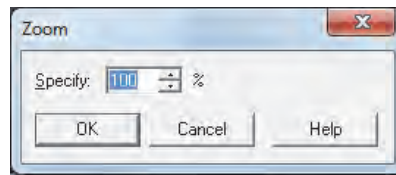

Zoom shows the magnification of the editing window.

Click **Zoom** on the status bar to display the Zoom dialog box.



Specify: You can specify the zoom magnification (50% to 400%).



You can also specify the zoom magnification by dragging the zoom slider or clicking  and .

● Customizing the status bar

You can change the commands displayed on the status bar.

Right click the status bar and check only the commands you want to display on the status bar.

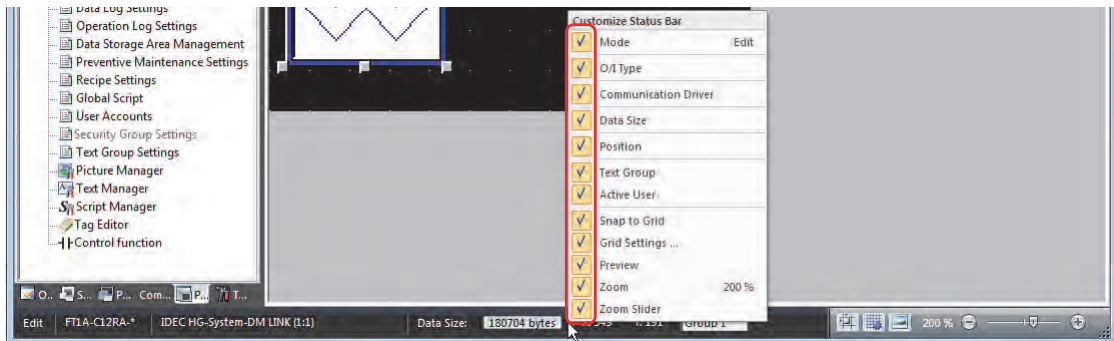

4 Customizing WindO/I-NV3

4.1 Configuring the Work Environment

You can configure WindO/I-NV3 settings such as mode and options when editing screens, the path when selecting files, and the path for automatic backups. The settings configured here are saved even when you exit WindO/I-NV3.

The procedure for configuring the work environment is shown below.

- 1 Click  and then click **WindO/I-NV3 Options**.

The WindO/I-NV3 Options dialog box is displayed.

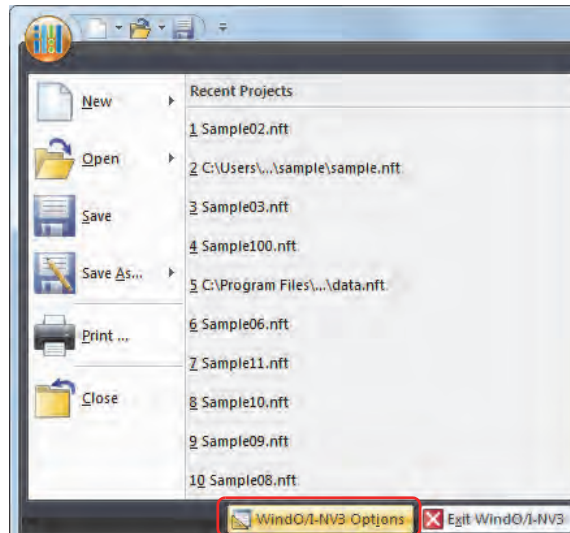

- 2 Change the settings on each tab as desired.

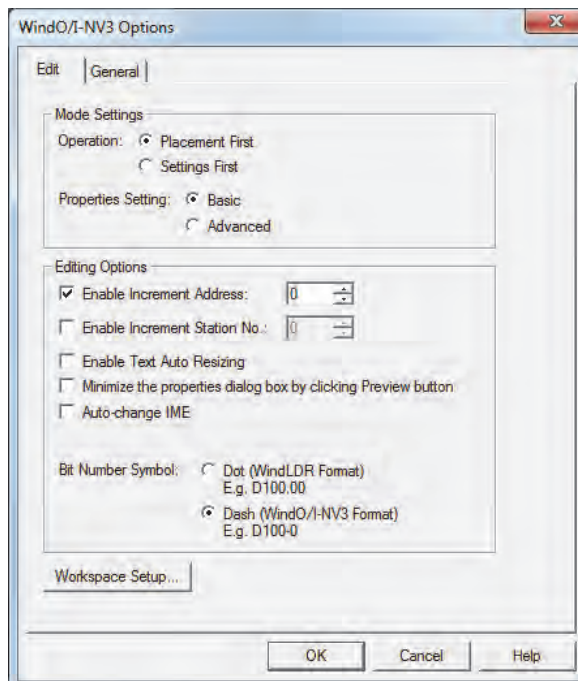

● Edit tab

■ Mode Settings

When placing a part on the screen, select whether or not to display the part's Properties dialog box.

Placement First: The part's Properties dialog box is not displayed. This mode is for placing the parts on the screen and finishing the screen's design first.

Settings First: Displays the part's Properties dialog box. This mode is for creating the screen while configuring the Properties for the parts.

■ Properties Setting

Select whether or not to display the Properties dialog box for parts in the Advanced mode.

Basic: Displays the Properties dialog box in Basic mode to use only basic functions.

Advanced: Displays the Properties dialog box in Advanced mode so that all functions can be used.



You can also change the mode by clicking **Advanced** or **Basic** in the Properties dialog box for parts.

■ Enable Increment Address

When copying or duplicating parts, select this check box to add a specified value (-999 to 999) to the device address set for the original part before pasting it to the screen.

■ Enable Increment Station No.

When copying or duplicating parts, select this check box to add a specified value (-999 to 999) to the device station number set for the original part before pasting it to the screen.

This option can only be configured if the communication driver **Connection** is **1:N Communication**.

■ Enable Text Auto Resizing

Select this box to automatically change the text size according to a change in part size.

■ Minimize the properties dialog box by clicking Preview button

Select this box to minimize an object's Properties dialog box when you click **Preview** on its properties dialog box.

■ Auto-change IME

Select this box to enter characters other than alphanumeric characters using the input method editor (IME) in text boxes for entering device addresses.



You cannot enter full-width characters in text boxes that only accept alphanumeric input, even if the IME is enabled.

Select this box to use full-width characters in tag names in the device address settings.

■ Bit Number Symbol

Select the separator for addresses and bits. When manually entering device address, you can enter either separator, but they will be displayed using the symbol selected here.

Dot (WindLDR Format): Separates the address and bit with a dot.
Example: LDR100.00

Dash (WindO/I-NV3 Format): Separates the address and bit with a dash.
Example: LDR100-0

■ Workspace Setup

Displays the Workspace Setup dialog box. You can configure items displayed in the workspace window. For details, refer to "4.2 Customizing the Workspace" on page 2-59.

● General tab

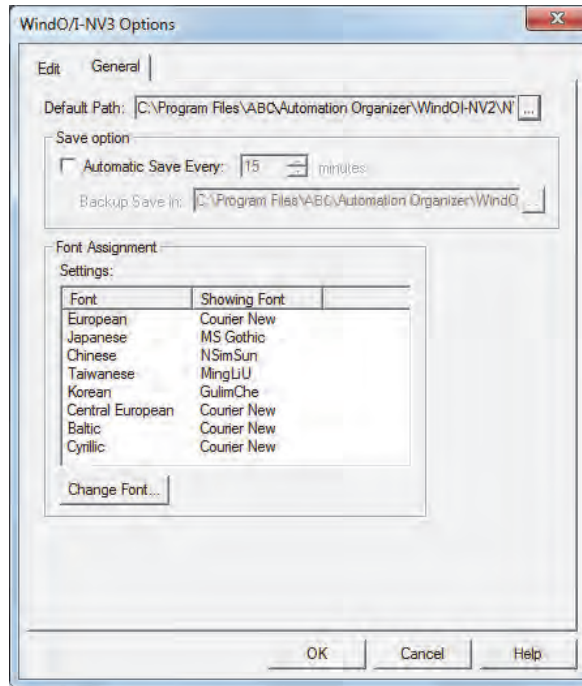

■ Default Path

Specifies the path when saving project data and opening files.

Click to display the Select Path dialog box. Select the folder, and then click **OK**.

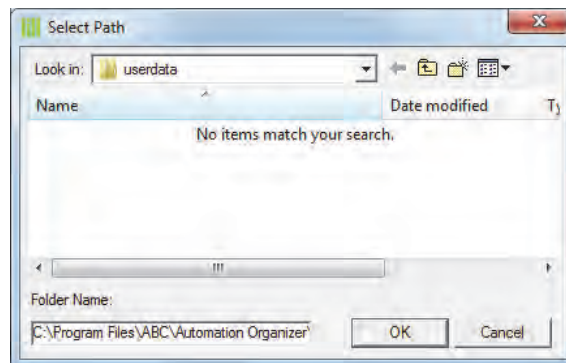

■ Save option

Automatic Save Every: Select this check box to automatically backup the project data at fixed time intervals (1 to 120 minutes).

Backup Save in: Specifies the location to save the backup data.

Click to display the Select Path dialog box. Select a folder, and then click **OK**.

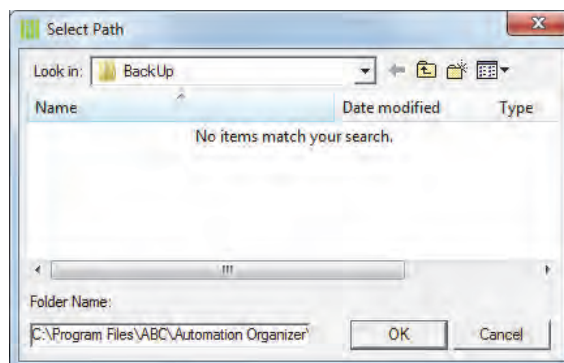

Backup data is deleted when the project data is closed.

■ Font Assignment

This option specifies the text font in the Properties dialog box for objects to display in text boxes and messages to display on the screen.

Select a **Font** in **Settings**, and then click **Change Font** to display the Font Settings dialog box. Select the font to use, and then click **OK**.



Font Assignment configures the fonts displayed in WindO/I-NV3. Fonts displayed on the Touch are not changed. To display the same font on the Touch as the font displayed in WindO/I-NV3, select Windows Font in the Properties dialog box for objects or Font setting in Text Manager.

For details, refer to "Windows Font" on page 2-12.

4.2 Customizing the Workspace

You can change the windows that are displayed in the workspace with the Workspace Setup dialog box.

● Screen List tab

This tab changes the **Screen List** window display.

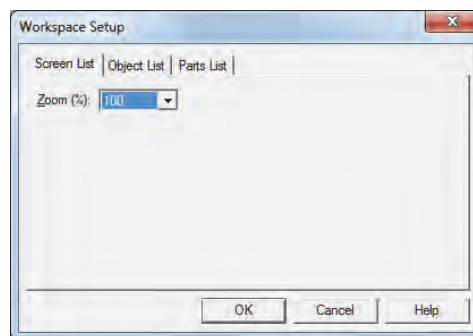

■ Zoom

Select the zoom magnification for the thumbnails displayed in the **Screen List** window from the following.

100, 125, 150, 175, 200, 250, 300, 350, 400

● Object List tab

This tab changes the items displayed in the **Object List** window.

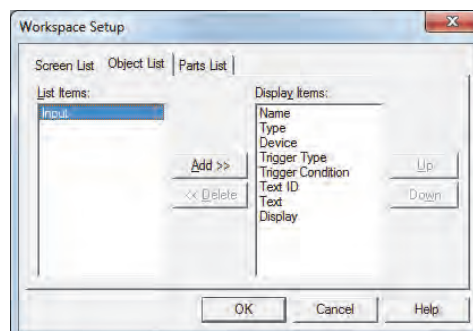

■ List Items

Shows the list of items that can be displayed in the **Object List** window.

■ Add

Adds an item to **Display Items**.

Select an item in **List Items**, and then click this button to add it to **Display Items**.

■ Delete

Deletes an item from **Display Items**.

Select an item in **Display Items**, and then click this button.

■ Display Items

Shows the list of items that are displayed in the **Object List** window.

- **Up**
Shifts the selected item upward in the **Display Items** list.
- **Down**
Shifts the selected item downward in the **Display Items** list.
- **Parts List** tab
This tab changes the items displayed in the **Part List** window.

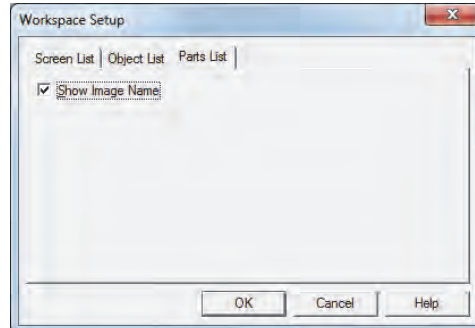

- **Show Image Name**
Select this box to display the image name for parts in the **Part List** window.

5 WindO/I-NV3 Common Operations and Settings

This section describes common settings when creating project data.

5.1 Device Address Settings

Device addresses are memory on the Touch and external devices that can store values in bit or word units. By setting device addresses to parts and functions, you can control the screen display and operation of parts. Device addresses are specified by combining the device type and address in the following formats.

Dot (WindLDR Format):

Device type	Address	.	Bit
-------------	---------	---	-----

Dash (WindO/I-NV3 Format):

Device type	Address	-	Bit
-------------	---------	---	-----

↑
Address and bit separator

The device address can be directly entered or it can be set with the Device Address Settings dialog box.

- **Direct entry**

Enter a device address with the keyboard following the basic format.

To enter the bit (0 to 15) for a word device, enter the address, the bit separator "." or "-", and the bit. You can enter the address with either separator, but it is displayed according to the **Bit Number Symbol** setting. **Bit Number Symbol** is set on the **Edit** tab of the WindO/I-NV3 Options dialog box.

- **Specifying a device address with the Device Address Settings dialog box**

To display the Device Address Settings dialog box, click to the right of the text box for setting the device address. Use this dialog box to set the device address.

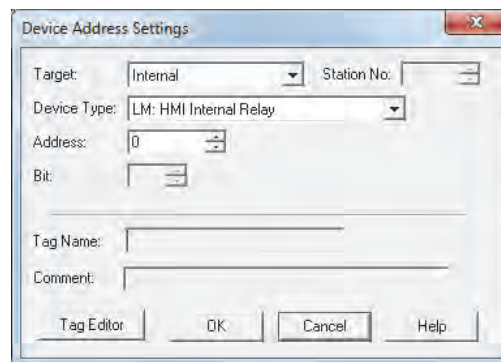

- **Target**

Select the device that includes the device address to set from **Touch** or **External Device**.

- **Station No.**

Specify the station number for the external device. The range that can be specified varies based on the communication driver selected.

This option can only be set when **1:N Communication** is selected on the **Connection** of the Select Communication Driver dialog box or the Change Communication Driver dialog box.

- **Device Type**

Select the device type.

The list only shows device types that can be used.

- **Address**

Specify the address. The range that can be set varies based on the device type selected.

- **Bit**

Specify the bit (0 to 15) of the word device when a word device is selected in **Device**.

- **Tag Name**

Shows the tag names configured for the selected device address.

■ **Comment**

Shows the comments configured for the selected device address.

■ **Tag Editor**

Opens the Tag Editor.

With the Tag Editor, you can display the list of device addresses used in the project data being edited and configure tag names and comments for device addresses.



Tag names and comments configured in the Tag Editor can be used in WindLDR and WindCFG.

5.2 Setting Conditional Expressions

Specify conditional expressions with **Condition** on the **Trigger Condition** tab.

Conditional expressions are specified by combining data and operators using the following basic format.

[Data] [Operator] [Data]

Directly enter the conditional expression or specify it with the Trigger Condition Settings dialog box.

● Direct entry

Enter the conditional expression with the keyboard.

- There is no limit on data or operators. However, the maximum number is 480 characters.

[Data] [Operator] [Data]
to

[Data] [Operator] [Data] [Operator] [Data] [Operator] [Data] [Operator] [Data] [Operator] [Data] ... (within 480 characters)

- To enter a device address for data, always enclose it with “[” and “]”.

Example: [LDR100] == 10

- To flip bits, enter “~” before the data.
- Parentheses “(” and “)” can be used.

([Data] [Operator] [Data]) [Operator] ([Data] [Operator] [Data])

- Operator priority is the same as scripts. For details, refer to Chapter 20 “6.4 About the Priority of the Operator” on page 20-53.

● Configuring conditional expressions with the Trigger Condition Settings dialog box

You can easily configure a basic conditional expression using the Trigger Condition Settings dialog box.

- Up to a maximum of five items of data can be used.

[Data] [Operator] [Data]
to

[Data] [Operator] [Data] [Operator] [Data] [Operator] [Data] [Operator] [Data]

- To flip the bits in data, select the **Not** check box.
- Operator priority is the same as scripts. For details, refer to Chapter 20 “6.4 About the Priority of the Operator” on page 20-53.

- 1 Click **Condition**  to display the Trigger Condition Settings dialog box.

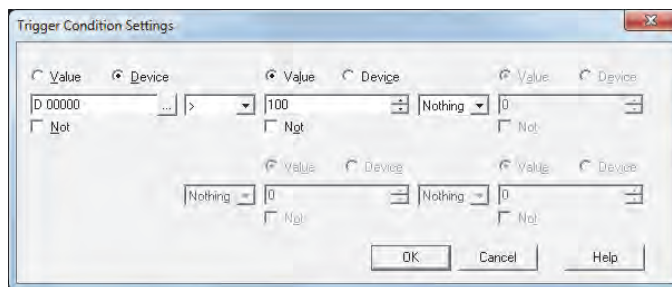

- 2 Click **Value** or **Device** and enter a value or device address.
To flip the bits in data, select the **Not** box.
- 3 Select the operator.
- 4 Click the next **Value** or **Device** and enter a value or device address.
To flip the bits in data, select the **Not** box.
- 5 Repeat steps 3 and 4 for the necessary number of conditions.



If you display the Trigger Condition Settings dialog box after directly entering a conditional expression, that expression will be reflected in the dialog box. However, if you entered an expression that cannot be reflected, the portion of the expression that could not be reflected is deleted when you click **OK** and close the Trigger Condition Settings dialog box.

● Data and operations that can be configured

Data

You can specify these types and values of data for conditional expressions.

Item	Description
Value	Set a constant number as data. The range that can be set differs according to the selected data type. For details, refer to "Data types" on page 2-1.
Device	Set a device address for a bit device or a word device that stores the value to be handled as data.

Operators

Specify the type of arithmetic operation to execute on the data. (In the table below, [a] indicates the operator's left-hand number, [b] indicates the right-hand number.)

Operator	Details			Supported device	
				Bit device	Word device
Arithmetic operators	+	Addition	Adds [a] and [b].	NO	YES
	-	Subtraction	Subtracts [b] from [a].	NO	YES
	*	Multiplication	Multiplies [a] and [b].	NO	YES
	/	Division	Divides [a] by [b].	NO	YES
	%	Modulo	Calculates the remainder after dividing [a] by [b].	NO	YES
Relational operators*1	==	Equal to	Compares if [a] is equal to [b].	YES	YES
	!=	Not equal to	Compares if [a] is not equal to [b].	YES	YES
	>=	Greater than or equal to	Compares if [a] is equal or greater than [b].	NO	YES
	<=	Less than or equal to	Compares if [a] is equal or less than [b].	NO	YES
	>	Greater than	Compares if [a] is greater than [b].	NO	YES
	<	Less than	Compares if [a] is less than [b].	NO	YES
Bitwise operators	&	Bitwise AND	Calculates the logical product (AND) of each bit in [a] and [b].	YES	YES
		Bitwise OR	Calculates the logical sum (OR) of each bit in [a] and [b].	YES	YES
	^	Bitwise XOR (exclusive OR)	Calculates the exclusive logical sum (XOR) of each bit of [a] and [b].	YES	YES
	~	Bitwise NOT	Flips the logic of each bits of [a]. For word device and fixed values, 0 will be 65535 and 65535 will be 0. For bit device, 0 will be 1, and 1 will be 0.	YES	YES
	<<	Left shift	Shifts each bit of [a] to left for [b] bit(s).	NO	YES
	>>	Right shift	Shifts each bit of [a] to right for [b] bit(s).	NO	YES
Logical operators*1	&&	Logical AND	Calculates the logical product (AND) of a conditional expression and a conditional expression.	NO	YES
		Logical OR	Calculates the logical sum (OR) of a conditional expression and a conditional expression.	NO	YES

 • You cannot select logical operators in the Trigger Condition Settings dialog box.
• You cannot mix bit devices and word devices in a conditional expression.

 • As a basic rule, conditional expressions are calculated in order from the left, but when multiple arithmetic operations are combined, they are calculated according to the operator priority.
For [D10] == [D11] + [D12] * 2 + [D13], the expression is calculated in the following order.

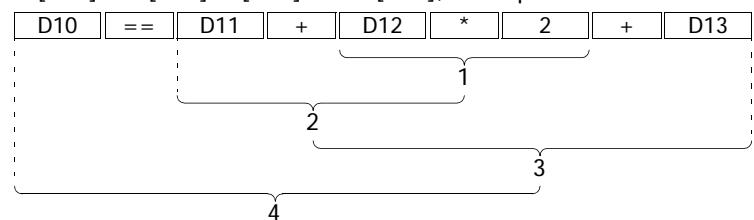

For the operator priority, refer to Chapter 20 "6.4 About the Priority of the Operator" on page 20-53.

*1 Returns 1 if satisfied or 0 if not satisfied.

● Setting and operation examples

Settings		Action
Direct entry	Trigger Condition Settings dialog box	
$[M0] == [M1]$	Data Op. Data M0 == M1	The condition is satisfied if the values of M0 and M1 are equal.
$[M0] == [M1] \& [M2]$	Data Op. Data Op. Data M0 == M1 & M2	The condition is satisfied if the result of the AND operation on M1 and M2 is equal to M0.
$[M0] == \sim[M1]$	Data Op. Data M0 & M1 <input checked="" type="checkbox"/> Not	The condition is satisfied if the result of flipping the bits in M1 is equal to M0.
$1234 == [D0]$	Data Op. Data 1234 == D0	The condition is satisfied if the value of D0 equals 1234.
$100 \leq [D0] + [D1] + [D2] + [D3]$	Data Op. Data Op. Data 100 <= D0 + D1 Op. Data Op. Data + D2 + D3	The condition is satisfied if the result of adding the values of D0 through D3 is 100 or greater.
$0 \neq [D0] \% 10$	Data Op. Data Op. Data 0 != D0 % 10	The condition is satisfied if the value of the remainder after D0 is divided by 10 does not equal 0 (the value of D10 cannot be entirely divided by 10).
$[D0] == \sim[D1] \& \sim[D2] \& [D3] \& [D4]$	Data Op. Data Op. Data D0 == D1 == D2 <input checked="" type="checkbox"/> Not <input checked="" type="checkbox"/> Not Op. Data Op. Data & D3 & D4	The condition is satisfied if the logical AND operation on the flipped bits of D1, the flipped bits of D2, the value of D3, and the value of D4 is equal to D0.
$[D10] + [D11] == [D12] + [D13]$	Data Op. Data Op. Data D10 + D11 == D12 Op. Data + D13	The condition is satisfied if the result of adding the values of D12 and D13 is equal to the result of adding the values D10 and D11.
$[D10] == [D11] + [D12] * 2 + [D13]$	Data Op. Data Op. Data D10 == D11 + D12 Op. Data Op. Data * 2 + D13	The condition is satisfied if the result of adding the values of D11, D12 multiplied by two, and D13 is equal to the value of D10.
$100 \leq [D0] + [D1] + [D2] + [D3] + [D4] + [D5] + [D6] + [D7]$	(This expression cannot be configured in the Trigger Condition Settings dialog box because it has over 6 items of data.)	The condition is satisfied if the result of adding the values of D0 through D7 is 100 or greater.
$1 == ([M0] \&\& [M1]) \ \ ([M2] \&\& [M3])$	(This expression cannot be configured on the Trigger Condition Settings dialog box because it uses logical operators and it contains parentheses "(" and ".")	The condition is satisfied if the logical OR operation on the result of the logical AND operation on M0 and M1 and the result of the logical AND operation on M2 and M3 is equal to 1.
$[LDR10] + [LDR11] == [LDR12] * ([LDR13] + [LDR14])$	(This expression cannot be configured on the Trigger Condition Settings dialog box because it mixes bitwise operators and logical operators or it contains parentheses "(" and ".")	The condition is satisfied if the result of multiplying the value of LDR12 by the result of adding the values of LDR13 and LDR14 is equal to the result of adding the values of LDR10 and LDR11.

The settings and screen data required to run the Touch are contained in a data structure called a Project. You must create a project using WindO/I-NV3 and WindLDR, which is an editor to set control function, started from WindO/I-NV3 before creating the screens and configuring the settings for the Touch. This chapter describes the various settings required to create a project.

1 Creating WindO/I-NV3 Project Data

1.1 Creating New Project Data

- Create new project data by using the interactive quick start
You can create project data by following displayed dialog boxes and configuring settings step by step.

- 1 Click , and then click **New**.
A New Project dialog box is displayed.

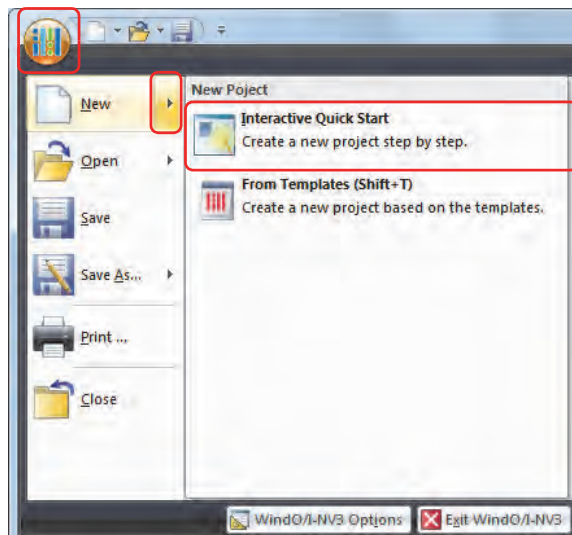

- 2 Enter the project name, and then click **Next**.
The Select Product Series dialog box is displayed.

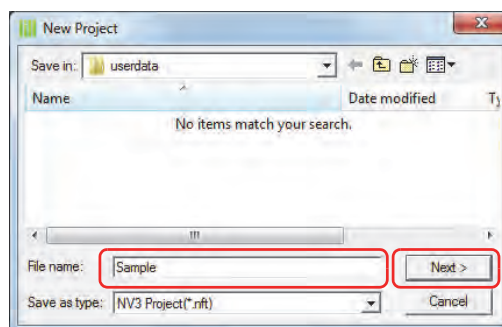

- You cannot use the following characters in the project name.
\\ / : ; * ? " < > |
- You cannot create project data in read-only folders or in WindO/I-NV3's working folders (temporary folders that start with "~").

3 Select **Product Series**, **Type Number**, and **Installation**, and then click **Next**.

The Select Communication Driver dialog box is displayed.

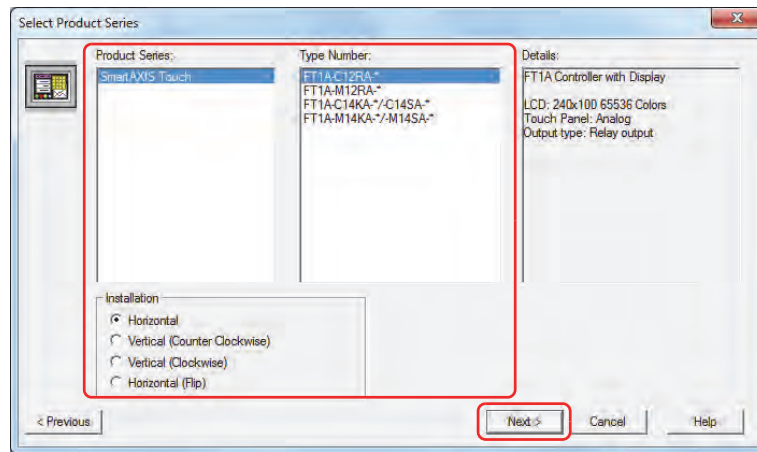

■ **Product Series**

Select the Touch type.

■ **Type Number**

A list of type numbers associated with the selected Touch is displayed. Select the type number to use.

■ **Installation**

Select the Touch installation direction from the following options.

Horizontal, Vertical (Counter Clockwise), Vertical (Clockwise), Horizontal (Flip)



You can go back to previous step to change the setting by clicking **Previous**.

4 Select **Manufacturer**, **Protocol**, and **Connection**, and then click **Next**.

The Project Settings dialog box is displayed.

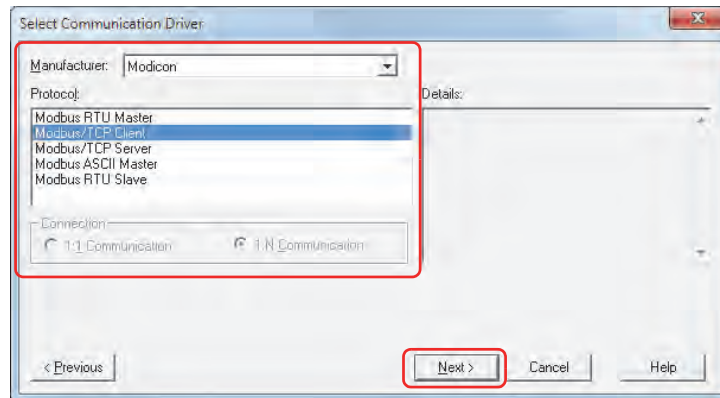

■ **Manufacturer**

Select the manufacturer name of the external device used.

■ **Protocol**

Shows the communication driver list for the select manufacturer. Select the communication driver to use.

■ **Connection**

Select the connection according to the number of external devices.

1:1 Communication: The Touch is connected to a single external device.

1:N Communication: The Touch is connected to multiple external devices.



You can go back to previous step to change the settings by clicking **Previous**.

5 Configure the settings on each tab as necessary, and then click **OK**.

For details about the Project Settings dialog box, refer to “3 Project Settings Dialog Box” on page 3-19.

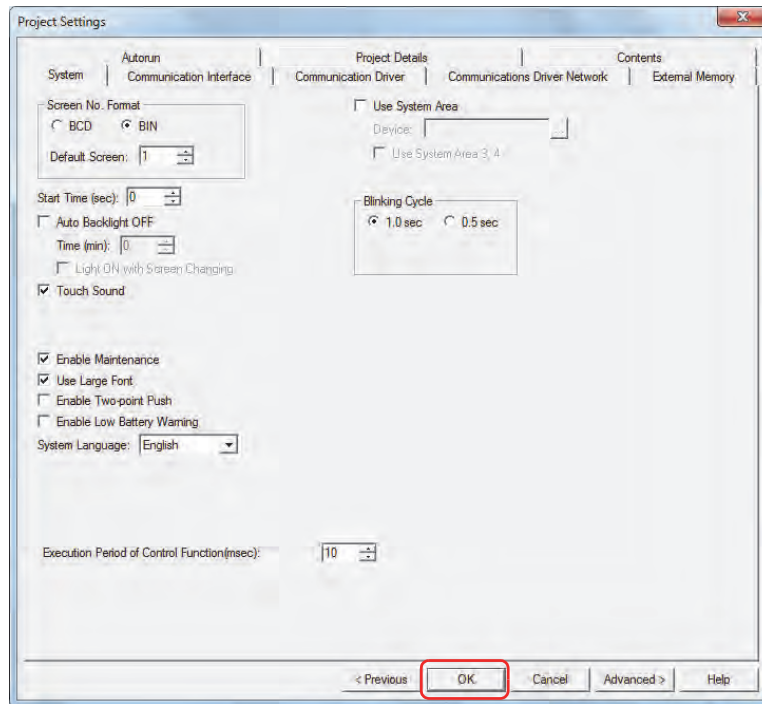

- The Project Settings dialog box can also be accessed using the following methods.
 - Click **Project** on the **Configuration** tab
 - Double click **Project Settings** in the **Project** window
- You can go back to previous step to change the settings by clicking **Previous**.

This concludes creating project data.

Next you will create a screen. For details, refer to Chapter 4 “3.1 Base Screen Settings” on page 4-14.

1.2 Opening Project Data

- Opening project data

You can open project data that has already been created.

- 1 Click , and then click **Open**.

The Open dialog box is displayed.

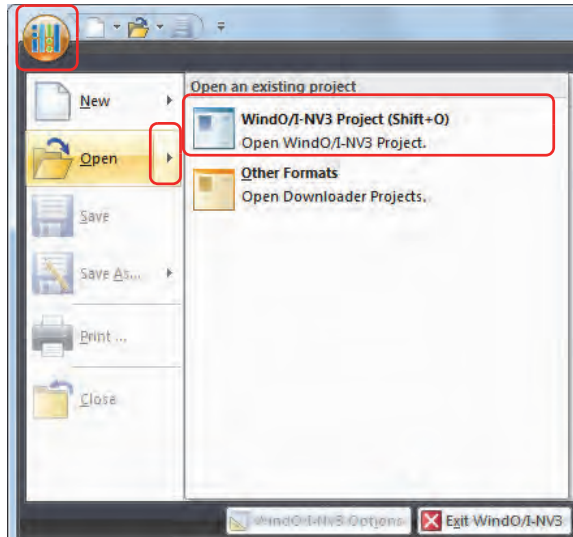

- 2 Select the file, and then click **Open**.

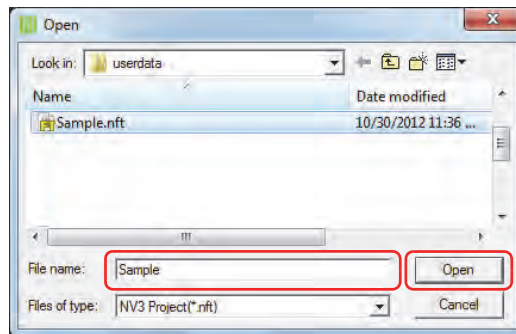

If a password has been configured for the project data, the Enter Password screen will be displayed. Select the user name and enter its password. For details, refer to Chapter 21 "User Accounts and the Security Function" on page 21-1.

Next you will open a screen. For details, refer to Chapter 4 "2.2 Opening Screens" on page 4-2.



Click , and then click project data on the **Recent Projects** list to open a project data.

1.3 Saving Project Data

- Saving project data

You can save the project data being edited.

Click , and then click **Save**.

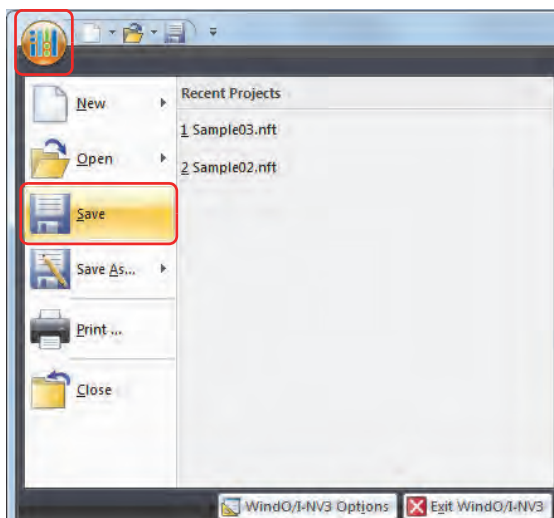

● Saving project data with a different name

You can save the project data being edited with a different name.

- 1 Click , and then click **Save As**.

The Save As dialog box is displayed.

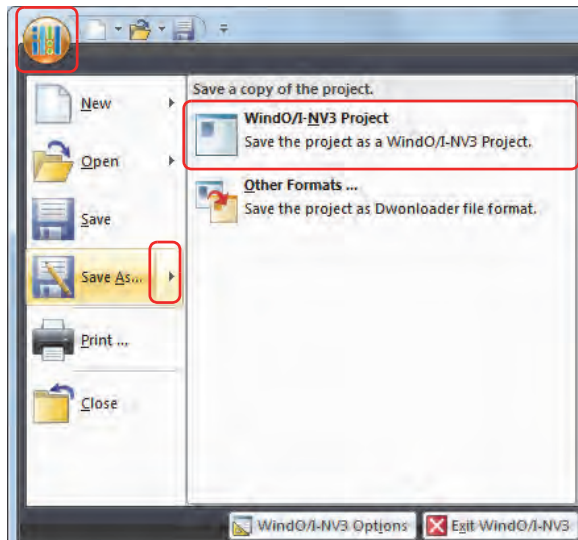

- 2 Enter the project name, and then click **Save**.

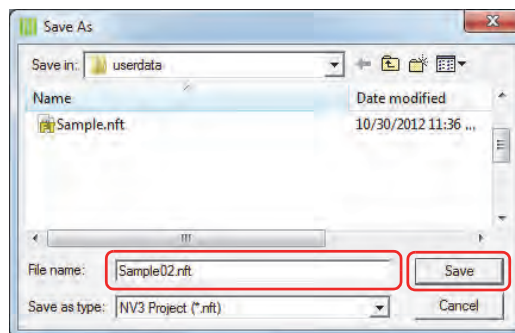

- You cannot use the following characters in the project name.
 \ / : ; * ? " < > |
- You cannot create project data in read-only folders or in WindO/I-NV3's working folders (temporary folders that start with "~").

1.4 Printing Project Data

You can print the settings for the project data being edited and its screen images.

- 1 Click , and then click **Print**.

The Print dialog box is displayed.

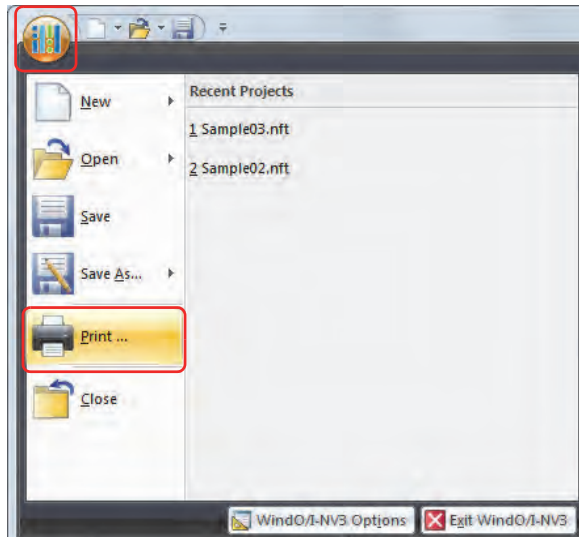

- 2 Change the settings on each tab as necessary.

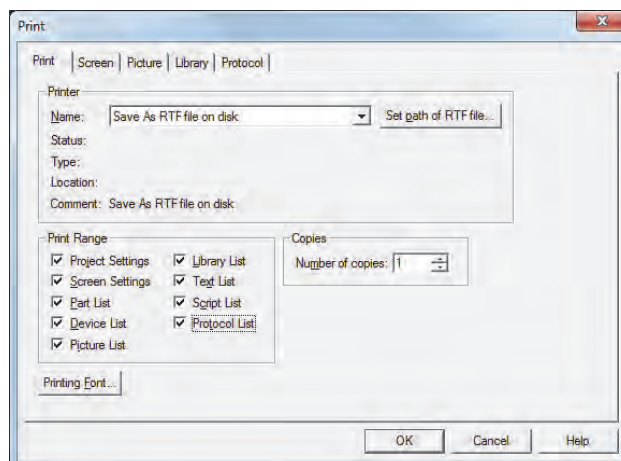

● Print Tab

■ Printer

- Name: Select a printer connected to the computer or **Save As RTF file on disk**.
You can output an RTF-formatted file by selecting **Save As RTF file on disk**.
- Set path of RTF file:** When outputting an RTF-formatted file, click this button to display the Save As dialog box. Specify the saved location, file name, and then click **OK**.
- Status: Shows the current status of the printer.
- Type: Shows the manufacturer and model of the printer.
- Location: Shows the destination or the location to save the file.
- Comment: Shows a comment entered in the Printer Properties dialog box.

■ Print Range

Select the items you want to print.

- Project Settings: Prints the project settings.
- Screen Settings: Prints the screen settings, a list of the parts on the screen, and a screen image. The details are configured on the Screen tab.
- Part List: Prints the settings for all parts used in the project.
- Device List: Prints the settings for all devices used in the project.
- Picture List: Prints the images and settings for drawing objects registered in Picture Manager. The details are configured on the Picture tab.
- Library List: Prints the settings and images for Library Screens. The details are configured on the Library tab.
- Text List: Prints all the text registered in Text Manager.
- Script List: Prints all the scripts registered in Script Manager.
- Protocol List: Prints the settings for Protocols registered in Protocol Manager. The details are configured on the Protocol tab.

When the following items are selected, their tabs are displayed.

Item	Reference
Screen Settings	"Screen Tab" on page 3-9
Picture List	"Picture Tab" on page 3-10
Library List	"Library Tab" on page 3-11
Protocol List	"Protocol Tab" on page 3-12

■ Copies

Number of copies: Enter the number of copies to print (1 to 100).

■ Printing Font

Displays the Font dialog box. You can change the font used when printing.

● Screen Tab

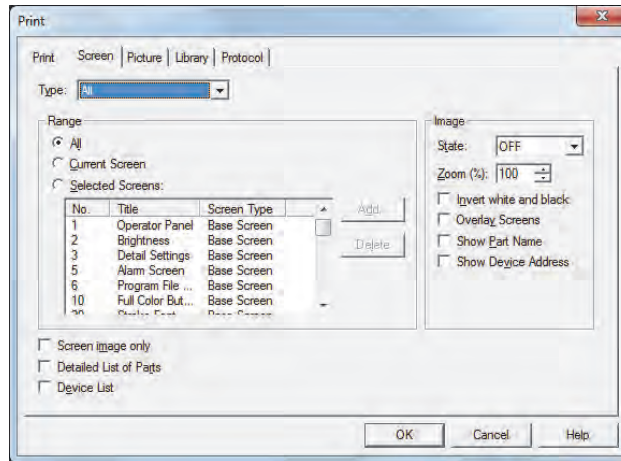

■ Type

Select the screens to print from the following items.

All, Base Screen, Popup Screen

■ Range

Select the screens to print from the selected type of screen.

All: Prints all the screens.

Current Screen: Prints the selected editing window screen.

Selected Screens: Prints the selected screens. The selected screens are displayed in a list.

Add: Adds a screen to the list.

Click **Add** to display the Open Screens dialog box. Select **Screen Type**, select the screen in **Screen List**, and then click **OK** to add the screen to the list.

Delete: Deletes the screen from the list.

Select the screen in the list, and then click **Delete**.

■ Image

State: Changes the state of the parts for printing. Select the state from the following items.

OFF, ON, ON, OFF (Both)

Zoom: Prints the screen image at the specified magnification (20% to 400%).

Invert white and black: Select this to print the screen by inverting the colors so white is black and black is white.

Overlay Screens: Select this to print the screen by displaying overlay screens.

Show Part Name: Select this to print the screen by displaying part names.

Show Device Address: Select this to print the screen by displaying device addresses.

■ Screen image only

Prints only the screen type, number, and screen image.

■ Detailed List of Parts

Prints part settings for each screen. This can only be selected when **Screen image only** is cleared.

■ Device List

Prints device settings for each address. This can only be selected when **Screen image only** is cleared.

● **Picture Tab**

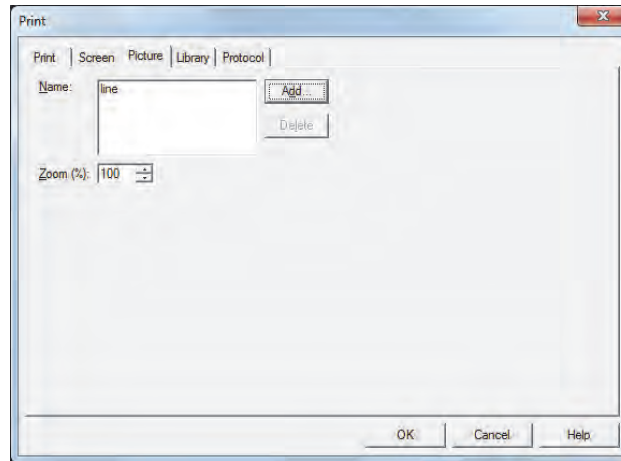

■ **Name**

Shows a list of selected drawing object names.

Add: Adds a drawing object to the list.

Click this button to display Picture Manager. Select a picture, and then click **Select** to add it to the list.

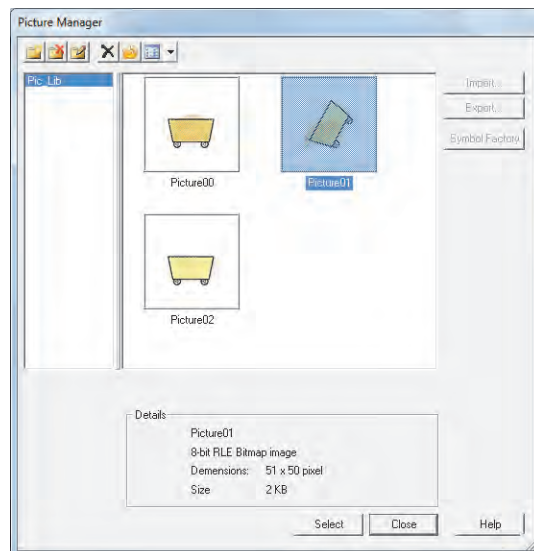

Delete: Deletes a picture from the list.
Select the picture name, and then click this button.

■ **Zoom**

Prints the picture at the specified magnification (20% to 400%).

● Library Tab

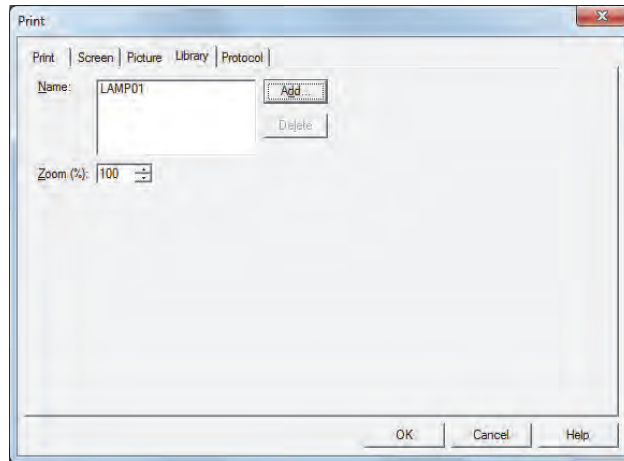

■ Name

Shows a list of selected library names.

Add: Adds a library to the list.

Click this button to display the **Select Library for Print** dialog box. Select a library and then click **OK** to add it to the list.

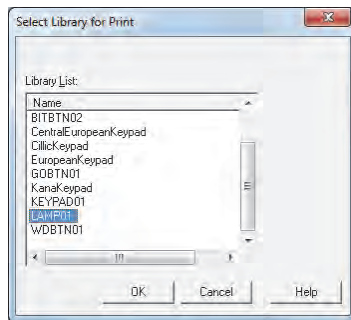

Delete: Deletes a library from the list.
Select a library name and click this button.

■ Zoom

Prints the library image at the specified magnification (20% to 400%).

● **Protocol Tab**

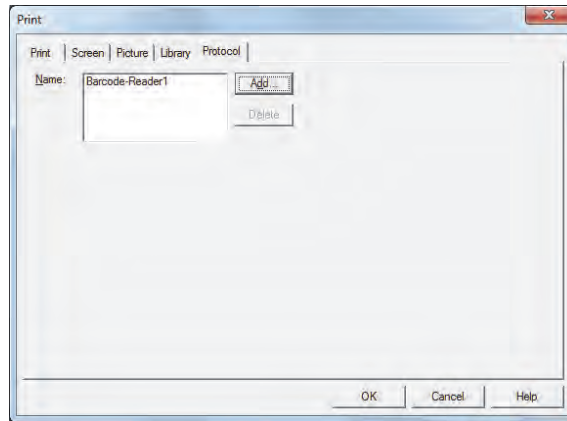

■ **Name**

Shows a list of selected Protocol names.

Add: Adds a Protocol to the list.

Click this button to display Protocol Manager. Select a protocol, and then click **Select** to add it to the list.

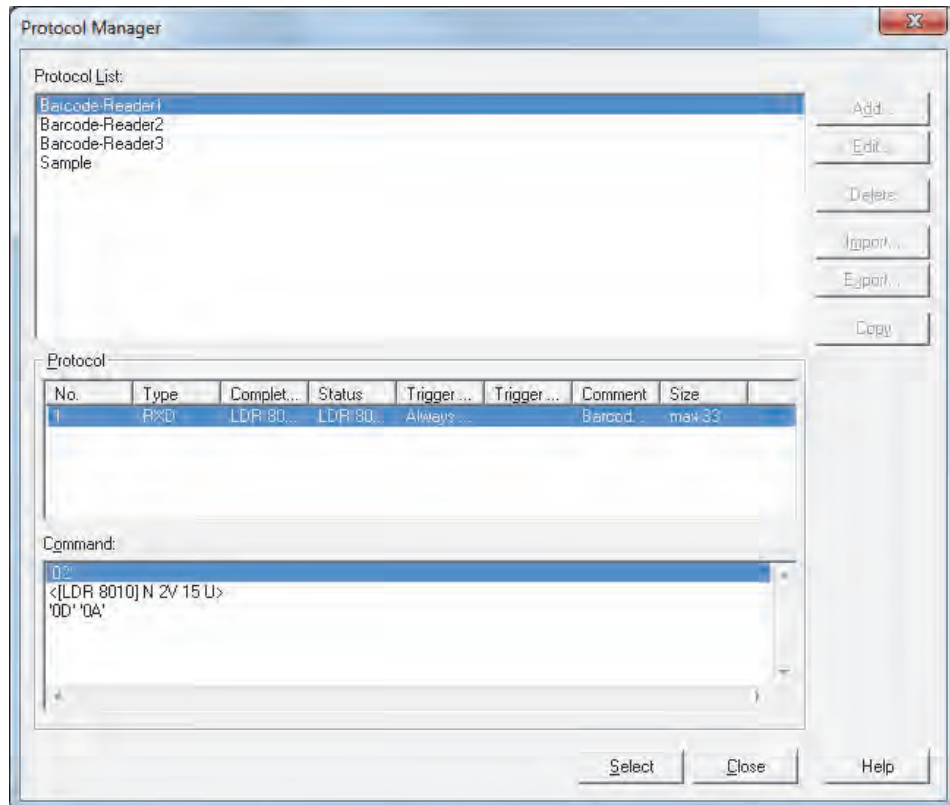

Delete: Deletes a protocol from the list.
Select a protocol name, and then click this button.

1.5 Comparing Project Data

Compares project data during editing with the screens and scripts of saved projects.

- 1 On the **Home** tab, in the **Project** group, click **Compare**.

The Open dialog box is displayed.

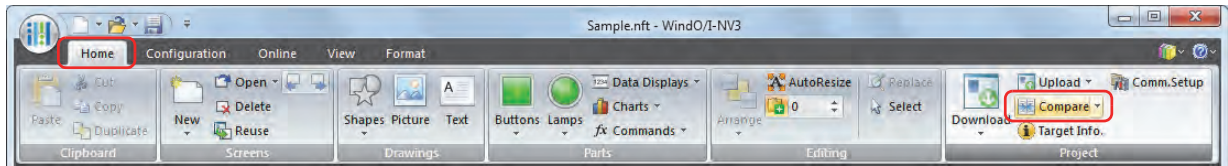

- 2 Select a file to compare with, then click **Open**.

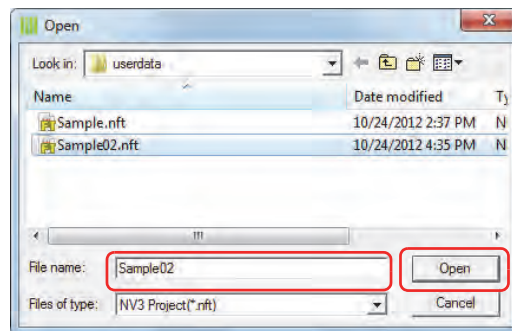

The **Comparison Result** window is displayed.

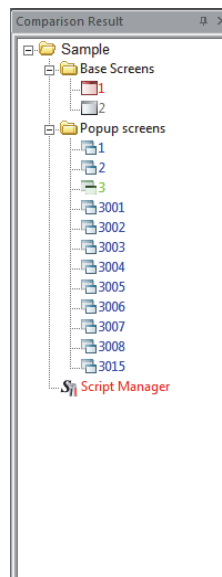

Comparison results are displayed using colored text.

Blue: Complete match

Red: Different content

Green: Only saved in the open project

Gray: Only saved in the comparison project



To compare with the comparison project data again, click the arrow to the right of **Compare** from the **Project** group of the **Home** tab, then click **Recompare**.

1.6 Changing Project Settings

● Changing Product Series

Changes the product series set in the project data being edited.

1 Click **Change Product Series** on the status bar.

The Change Product Series dialog box is displayed.

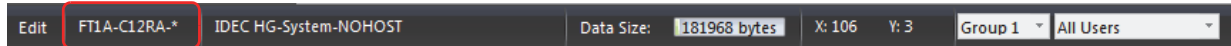

2 Select **Product Series**, **Type Number**, and **Installation**, and then click **OK**.

The Destination path for Convert dialog box is displayed.

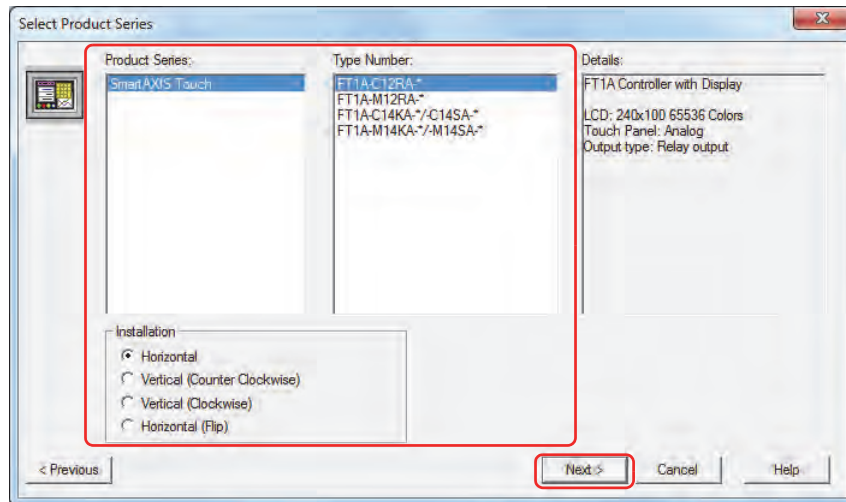

3 Specify the save location and file name, and then click **Save**.

The data conversion process begins.

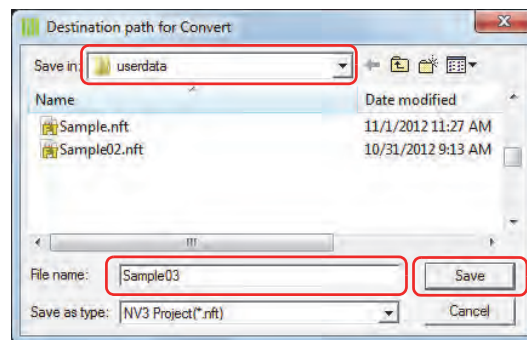

4 When the data is finished being converted, click **Close**.

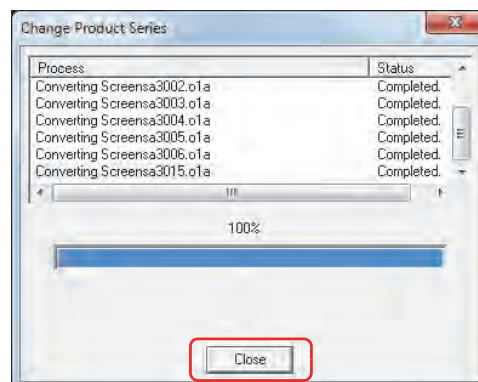

Color settings (color data) are not converted.

● Changing Communication Drivers

This section shows how to change the communication driver set in the project data being edited.

- 1 Click **Change Communication Driver** on the status bar.

The Change Communication Driver dialog box is displayed.

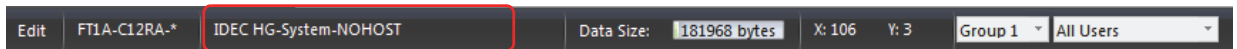

- 2 Select **Manufacturer**, **Protocol**, and **Connection**, and then click **OK**.

The confirmation message is displayed.

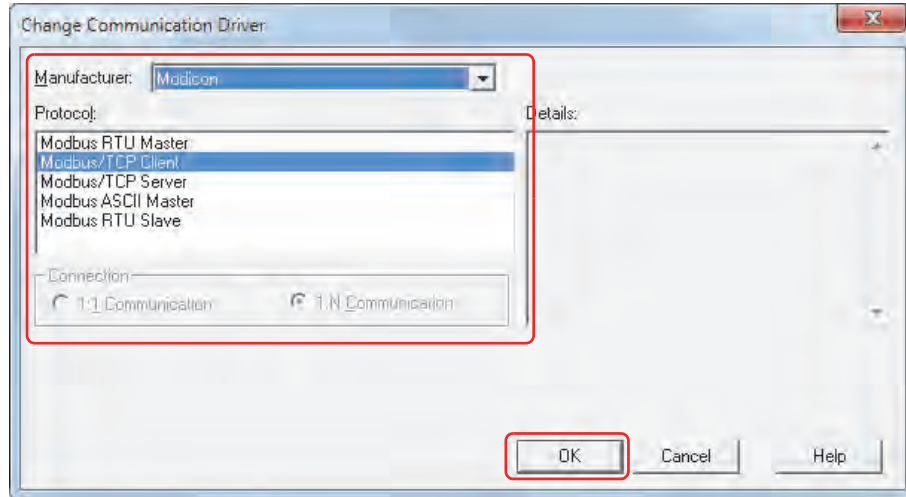

- 3 Check the message, and then click **OK**.

The Destination path for Convert dialog box is displayed.

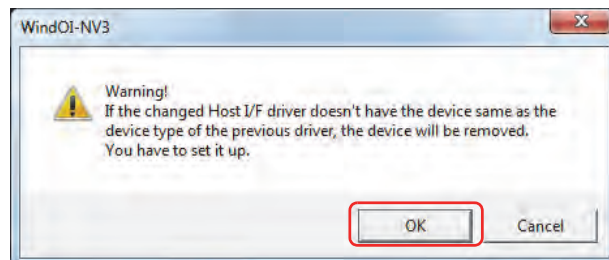

- 4 Specify the save location and file name, and then click **Save**.

The data conversion process begins.

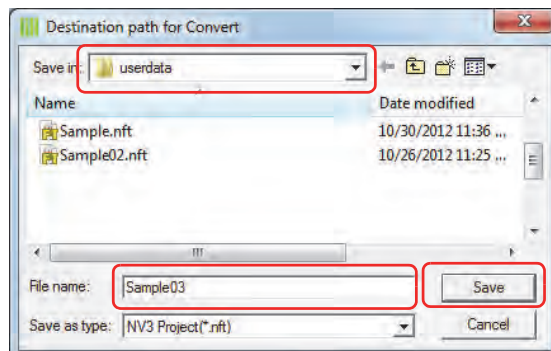

- 5 When the data is finished being converted, click **Close**.

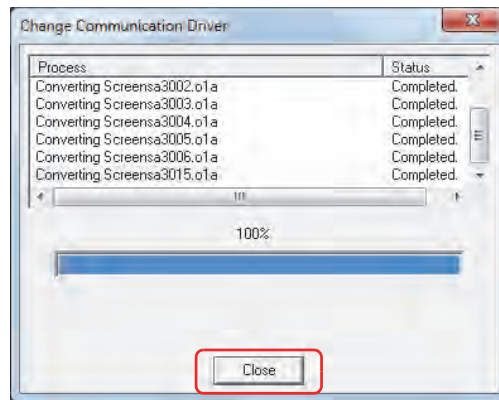

If there are no devices that correspond to the external device used in the current project data after changing the communication driver, the items set with those devices are blank.

1.7 Closing Project Data

You can close the project data being edited.

Click , and then click **Close**.

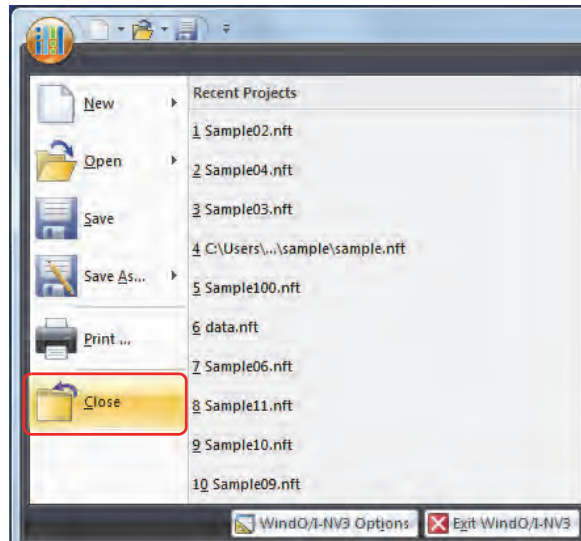

If the project data being edited has not been saved, a confirmation message for saving the project data is displayed.

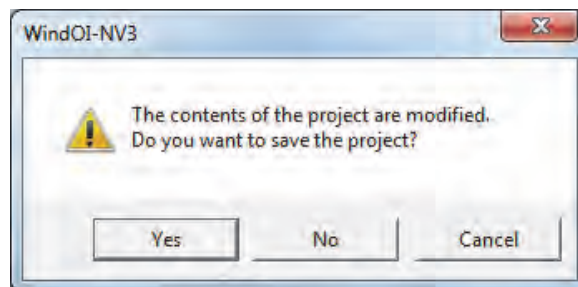

- Click **Yes** to save the project data and close it.
- Click **No** to close the project data without saving changes.
- Click **Cancel** to stop saving the project data.

2 Project Settings Configuration Procedure

The Project Settings dialog box is used to configure Touch operations and functions for the project overall. This section describes the configuration procedure for project settings.

- 1 On the **Configuration** tab, in the **System Setup** group, click **Project**. The Project Settings dialog box is displayed.

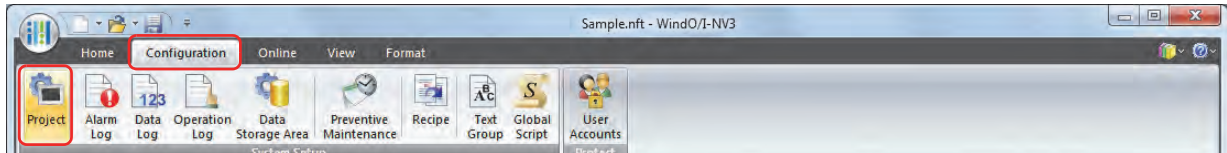

- 2 Change the settings on each tab as necessary.

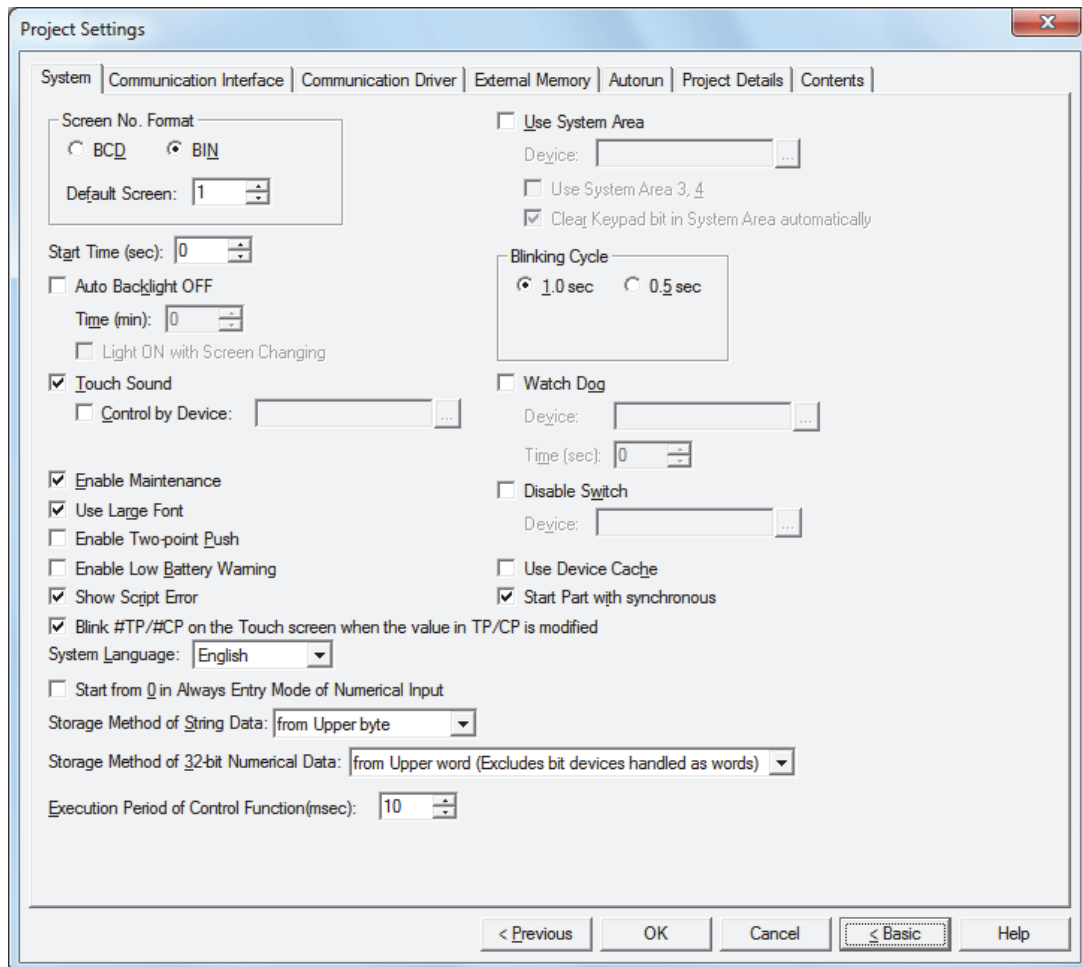

3 Project Settings Dialog Box

This section describes items and buttons on the Project Settings dialog box.

3.1 System Tab

The **System** tab is used to configure Touch operations.

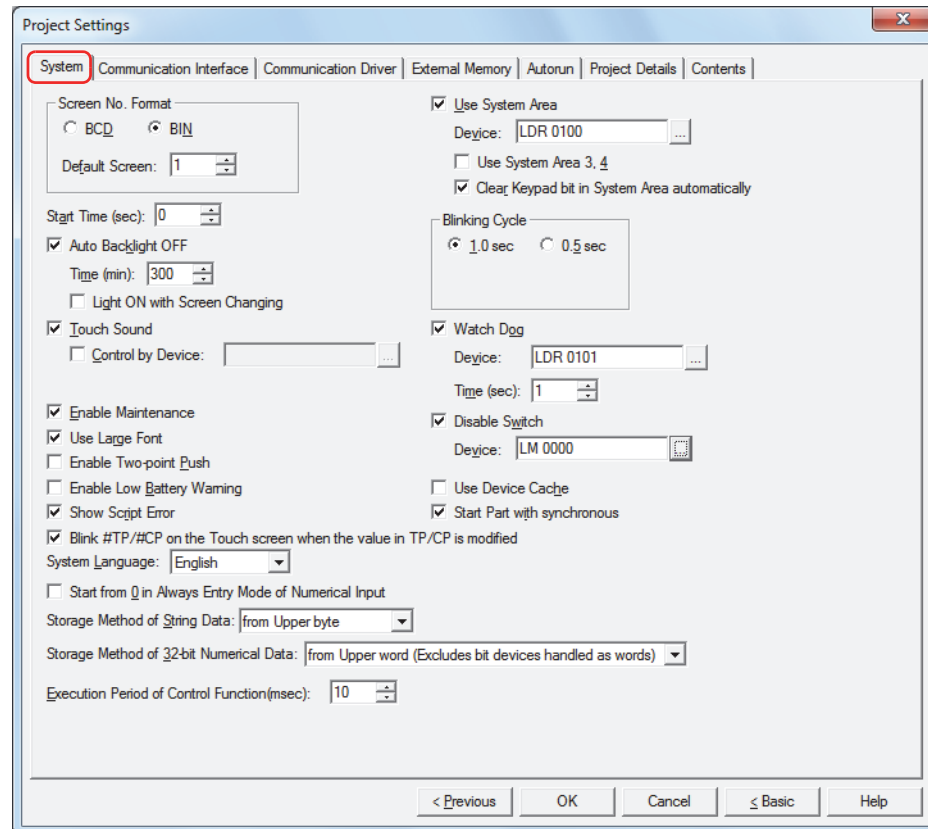

■ Screen No. Format

Selects the type of data to use for the System Area 1 Display screen number (address+0) as **BCD** or **BIN**.

Default Screen: Specifies the screen number of the Base Screen to display first when the Touch is turned on (0 to 3000). When 0 is specified, the Touch is in the screen waiting state. Write a screen number to System Area 1 Display screen number (address+0) or specify the default screen number from 1 to 3000.

■ Start Time (sec)

Specifies the time from when the Touch power is turned on until communications start with the external device (0 to 9999 seconds).

■ Auto Backlight OFF

Select this check box to turn off the backlight when the Touch is untouched for an extended period of time. To turn on the backlight, touch the screen or write 1 to System Area 1 Auto Backlight OFF bit (address+1, bit 5) or System Area 1 Screen display bit (address+1, bit 7).

Time (min): Specifies the time from when the Touch is last used to when the backlight is turned off (1 to 9999).

Light ON with Screen Changing: When the backlight is turned off with this function, select this check box to turn on the backlight when the screen is switched.

This option can only be configured when the **Auto Backlight OFF** check box is selected.

■ Touch Sound

Select this check box to play a sound when the screen is pressed.

Control by Device^{*1}: Select this check box to control the touch sound with a value of device. This option can only be configured when **Touch Sound** is selected.

(Device): Specifies the word device that controls the touch sound.

Click  to display the Device Address Settings dialog box. For the device address configuration procedure, refer to Chapter 2 "5.1 Device Address Settings" on page 2-61.

The control over a touch sound with a value of device is as follows.

0: Do not play the touch sound.

1: Play the touch sound.

2: Play a shortened touch sound.

■ Enable Maintenance

Select this check box to display the maintenance screen during operation. The methods for displaying the maintenance screen are as follows.

Press the upper-left corner of the Touch screen for three seconds or more.

If the Base Screen is switched before three seconds have elapsed, the load operation for the maintenance screen will be canceled. Please press the screen again.

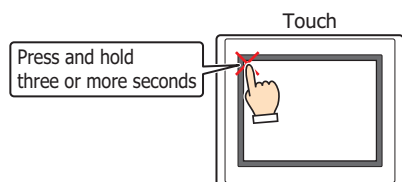

■ Use Large Font

Select this check box to display text on the Touch in high-quality fonts. The **Japanese** or **European** font is replaced with the high-quality fonts depending on the magnification.

To use high-quality fonts, the fonts must be downloaded to the Touch at the same time as the project. To download fonts, click **Options** in the Download dialog box to display the Options dialog box. Select the **Download additional fonts** check box, select the check boxes of the high-quality fonts to use (Japanese large font (First standard), Japanese large font (Second standard), European large font), and then click **OK**.

For details on high-quality fonts, refer to Chapter 2 "High-quality Fonts" on page 2-9.

■ Enable Two-point Push

Select this check box to enable two-point push for touch switches. When two-point push is enabled, the bottom switch and the switch above it operate in order.

On an analog touch panel, this function operates two overlapping switches when the two are pressed. This is not a function to simultaneously operate two touch switches when they are both pressed.

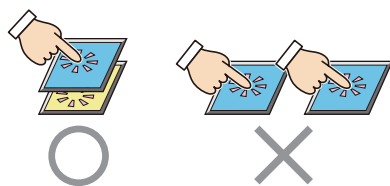

■ Enable Low Battery Warning

Select this check box to display a warning when the backup battery is dead.

■ Show script error^{*1}

Select this check box to display an error message on the screen when a script error occurs.



Script error information is saved to the HMI special registers (LSD 52 and LSD 53). For details, refer to Chapter 20 "1.4 Script Error of HMI Function" on page 20-4.

■ Blink #TP/#CP on the Touch screen when the value in TP/CP is modified

Select this check box to flash the message "TP/CP" on the screen when the preset value of the timer or the counter in control devices change. For details on "TP/CP" displayed on the screen, refer to Chapter 30 "TP/CP" on page 30-2.

*1 Advanced mode only

■ System Language

Selects the display language for the Maintenance Screen, Device Monitor, Adjust Brightness Screen^{*2}, and Adjust Brightness/Contrast Screen^{*3} as **English** or **Japanese**.

For details, refer to Chapter 28 "1 Maintenance Screen" on page 28-1.

■ Start from 0 in Always Entry Mode of Numerical Input^{*1}

Select this check box to display 0 when a Numerical Input that has the **Always Entry Mode** check box selected on the **General** tab is displayed on the screen. When this check box is cleared, the value of device is displayed.

This option is reflected for all Numerical Inputs configured in the project.

■ Storage Method of String Data^{*1}

Selects the handling method for text entered with the Character Input and values of devices read by the Message Display.

from Upper byte:

The values of devices are read from and written to the upper byte.

Example: When the text ABCDE is entered with the Character Input and written to the destination device LDR100

Device	Stored value	
	Upper byte	Lower byte
LDR100	'A' = 41 (hex)	'B' = 42 (hex)
LDR101	'C' = 43 (hex)	'D' = 44 (hex)
LDR102	'E' = 45 (hex)	0

NULL terminating character

from Lower byte:

The values of devices are read from and written to the lower byte.

Example: When the text ABCDE is entered with the Character Input and written to the destination device LDR100

Device	Stored value	
	Upper byte	Lower byte
LDR100	'B' = 42 (hex)	'A' = 41 (hex)
LDR101	'D' = 44 (hex)	'C' = 43 (hex)
LDR102	0	'E' = 45 (hex)

NULL terminating character



When handling strings, 0 is written to the device as the NULL terminating character and treated as the end of the string.

■ Storage Method of 32-bit Numerical Data^{*1}

Selects the handling method for the values of devices when **BIN32(+)**, **BIN32(+/-)**, **BCD8**, or **float32** is selected for **Data Type** from the following.

This setting only applies to word devices. When the bit devices in control devices are handled as words, this setting is always **from Lower word**.

from Upper word (Excludes bit devices handled as words):

Values of the word device are read from and written to the upper word.

Example: When **Data Type** for the Numerical Input is **BIN32(+)** and the numerical value 12345678 (hex) was entered and written to destination device LDR100

Device	Stored value	
LDR100	1234 (hex)	Upper word
LDR101	5678 (hex)	Lower word

from Lower word:

For word devices and bit devices handled as words, values of devices are read from and written to the lower word.

Example: When **Data Type** for the Numerical Input is **BIN32(+)** and the numerical value 12345678 (hex) was entered and written to destination device LDR100

Device	Stored value	
LDR100	5678 (hex)	Upper word
LDR101	1234 (hex)	Lower word

*1 Advanced mode only

*2 Color LCD models only

*3 Monochrome LCD models only

■ Execution Time of Control Function (msec)

Specifies the execution time for control function (5 to 1,000).
For details, refer to Chapter 12 "Execution Period" on page 12-2.

■ Use System Area

The System Area is an area of predetermined devices to control the screen, communicate error and time information between the Touch and the external device. Select this check box to use the System Area. For details, refer to "System Area" on page 3-23.

Device: Specifies the word device to use as the System Area. The System Area is allocated starting from the configured device address.

Click to display the Device Address Settings dialog box. For the device address configuration procedure, refer to Chapter 2 "5.1 Device Address Settings" on page 2-61.

Use System Area 3, 4: Select this check box to use System Area 3 and 4.

Clear Keypad bit in System Area automatically*¹: Select this check box to automatically set the System Area 2 Numerical Input setting and Character Input setting bits to 0 after they have been set to 1.
The System Area 2 bits cleared by this function are as follows.
Numerical Input setting complete (address+3, bit 0)
Numerical Input setting cancel (address+3, bit 1)
Character Input setting complete (address+3, bit 5)
Character Input setting cancel (address+3, bit 6)

■ Blinking Cycle

Selects the blinking cycle (displaying a drawing object by switching it on and off at a fixed interval) as **1.0 sec** or **0.5 sec**.

■ Watch Dog*¹

Select this check box to monitor whether or not the Touch and the external device are communicating by writing a set value (00FF (hex)) at a fixed interval.

Device: Specifies the word device to write the value.

Click to display the Device Address Settings dialog box. For the device address configuration procedure, refer to Chapter 2 "5.1 Device Address Settings" on page 2-61.

Time (sec): Specifies the interval to write the value (1 to 65535).

■ Disable Switch*¹

Select this check box to enable and disable touch switches with a value of device.
Touch switches are enabled when the value of device is 1. They are disabled when the value of device is 0.

Device: Specifies the bit device or bit of the word device that is read to enable or disable touch switches.

Click to display the Device Address Settings dialog box. For the device address configuration procedure, refer to Chapter 2 "5.1 Device Address Settings" on page 2-61.

■ Use Device Cache*¹

Select this check box to execute processing by reading all the values of external devices configured for a screen when switching the Base Screen or when displaying a Popup Screen. On the Touch, written values are reflected regardless of this option.

■ Start Part with synchronous*¹

Select this check box to operate commands and HMI Special Internal Relays LSM1, LSM2, LSM3, and LSM5 after reading all the values of external devices configured on the screen.

When this check box is cleared, all processing is immediately executed when the screen is displayed.

*¹ Advanced mode only

● System Area

Overview

The area of predetermined devices to control the screen and communicate error information and time information between the Touch and the external device is called the System Area.

The System Area on the Touch is as follows.

System Area	Number of word addresses	User Access
System Area 1	2	Read and write
System Area 2	2	Write
System Area 3	4	Read
System Area 4	4	Write

To use System Area 1 and 2, select the **Use System Area** check box on the Project Settings dialog box. To use System Area 3 and 4, select the **Use System Area 3, 4** check box.

Specify the word device to use as the System Area in **Device** to allocate the System Area starting at the configured device address.

Click  to display the Device Address Settings dialog box. For the device address configuration procedure, refer to Chapter 2 "5.1 Device Address Settings" on page 2-61.

Example: When **Device** is configured as LDR100

(Starting address)	LDR100	} System Area 1
+1	LDR101	
+2	LDR102	} System Area 2
+3	LDR103	
+4	LDR104	} System Area 3
+5	LDR105	
+6	LDR106	
+7	LDR107	
+8	LDR108	} System Area 4
+9	LDR109	
+10	LDR110	
+11	LDR111	

System Area 1

This area configures the Touch display, beep, and clearing bits.

Address	Bit	Function	Description
+0	0 to 15	Display screen number	This bit stores the number of the screen being displayed. Write a value to this bit to change the screen to that number. Immediately after the power is turned on, the value configured by Default Screen in the Project Settings dialog box is stored here. If the screen number does not exist in the project data, an error message (No screen data) is displayed. However, when 0 is written to this bit, the screen is not switched and no error message is displayed.
+1	0	Backlight	This bit stores the illumination state of the backlight. Write a value to this bit to change the state. 0: Off Turns the backlight off. 1: On Turns the backlight on.
	1	Blink backlight (1 sec. cycle)	This bit stores the screen blink state (1 sec. cycle). Write a value to this bit to change the state. This bit is 0 immediately after the power is turned on. 0: Do not blink Stop blinking the screen and turn it on. 1: Blink Blinks the screen in one second intervals. When Blink backlight (1 sec. cycle) (address+1, bit 1) and Blink backlight (0.5 sec. cycle) (address+1, bit 2) are both 1, the screen blinks at one second intervals.

Address	Bit	Function	Description
+1	2	Blink backlight (0.5 sec. cycle)	<p>This bit stores the screen blink state (0.5 sec. cycle). Write a value to this bit to change the state. This bit is 0 immediately after the power is turned on.</p> <p>0: Do not blink Stop blinking the screen and turn it on.</p> <p>1: Blink Blinks the screen in 0.5 second intervals. When Blink backlight (1 sec. cycle) (address+1, bit 1) and Blink backlight (0.5 sec. cycle) (address+1, bit 2) are both 1, the screen blinks at one second intervals.</p>
	3 to 4	Backlight color	<p>This bit stores the color of backlight. Write a value to this bit to change the color.</p> <p>Monochrome LCD models</p> <p>00: Reserved 01: White 10: Red 11: Pink</p> <p>Color LCD models</p> <p>01: White 00, 10 and 11: Reserved</p>
	5	Auto Backlight OFF	<p>This bit stores whether or not the function to automatically turn off the backlight is enabled when the Auto Backlight OFF check box is selected in the Project Settings dialog box. Write a value to this bit to change the state. This bit turns 0 immediately after power is turned on.</p> <p>0: Enabled Automatically turns off the backlight when the Touch is unused for an extended period of time.</p> <p>1: Disabled Does not automatically turn off the backlight when the Touch is unused for an extended period of time. The backlight turns on if the value changes to 1 when the backlight is off.</p>
	6	Beep	<p>This bit stores the beep state. Write a value to this bit to change the state. This bit turns 0 immediately after power is turned on.</p> <p>0: Stop Stops continuous beeping.</p> <p>1: Beep Starts continuous beeping.</p>
	7	Screen display	The function is the same as for Backlight (address+1, bit0)
	8	Reserved	
	9	Clear error	Write 1 to this bit to clear the error information bit (System Area 2 address+2). This bit automatically changes to 0 when processing is finished.
	10	Numerical Input setting clear	Write 1 to this bit to clear the Numerical Input setting complete bit (System Area 2 address+3, bit 0) and the Numerical Input setting cancel bit (System Area 2 address+3, bit 1). This bit automatically changes to 0 when processing is finished.
	11	Character Input setting clear	Write 1 to this bit to clear the Character Input setting complete bit (System Area 2 address+3, bit 5) and the Character Input setting cancel bit (System Area 2 address+3, bit 6). This bit automatically changes to 0 when processing is finished.
	12 to 15	Reserved	

System Area 2

This area stores Touch states and error information. These bits turn 0 immediately after power is turned on.

Address	Bit	Function	Description
+2	0 to 2	Reserved	
	3	Communication error	This bit changes to 1 when a communication error occurs in communication with external device using Serial Interface 1 (SIO1).
	4	Reserved	
	5	Arithmetic error	This bit changes to 1 when executing the following arithmetic operations. <ul style="list-style-type: none"> • A value other than 0 to 9 is used when the data type is BCD4 or BCD8 • Dividing by zero • When there is an inconsistency in the bar chart maximum, minimum, or origin setting, or the full range is 0 • When there is an inconsistency in the line chart maximum, minimum, or origin setting, or the full range is 0
	6	Device range error	This bit changes to 1 when writing a value to a device that falls outside its range or when exceeding the restrictions on the number of configured devices.
	7	Clock IC error	This bit changes to 1 when the Touch internal clock stops.
	8, 9	Reserved	
	10	Script error	This bit changes to 1 when an error occurs during script execution. Error details are stored in HMI Special Data Registers LSD52 and LSD53. For details, refer to Chapter 20 "1.4 Script Error of HMI Function" on page 20-4.
	11	USB flash drive access error	If an error occurs when accessing an inserted USB flash drive, the value of this bit becomes 1.
	12, 13	Reserved	
	14	Backup data error	This bit changes to 1 when the backup battery is dead or low and the data sampled by the log functions and the HMI Keep Registers and HMI Keep Relays are cleared.
15	Reserved		
+3	0	Numerical Input setting complete	This bit changes to 1 when finished entering a numerical value with the Numerical Input. Write 0 to Numerical Input setting clear (address+1, bit 10) to clear this bit.
	1	Numerical Input setting cancel	This bit changes to 1 when entering a numerical value with the Numerical Input was canceled. Write 0 to Numerical Input setting clear (address+1, bit 10) to clear this bit.
	2	Backlight auto off running	The value of this bit changes to 1 when Auto Backlight OFF is configured and the backlight was turned off by this function. To configure Auto Backlight OFF , select the Auto Backlight OFF check box on the System tab in the Project Settings dialog box. This bit automatically changes to 0 when the backlight turns on.
	3	Reserved	
	4	Transferring recipe	This bit changes to 1 when transferring recipe data. This bit automatically changes to 0 when the transfer is finished.
	5	Character Input setting complete	This bit changes to 1 when finished entering text with the Character Input. Write 0 to Character Input setting clear (address+1, bit 11) to clear this bit.
	6	Character Input setting cancel	This bit changes to 1 when entering text with the Character Input is canceled. Write 0 to Character Input setting clear (address+1, bit 11) to clear this bit.
	7 to 15	Reserved	

System Area 3

This area is for changing the Touch internal clock data.

Address	Bit	Function	Description
+4	0 to 7	Clock data Month	Enter Month (01 to 12) as a 2 digit BCD.
	8 to 15	Clock data Year	Enter Year (00 to 99) as a 2 digit BCD.
+5	0 to 7	Clock data Hour	Enter Hour (00 to 23) as a 2 digit BCD.
	8 to 15	Clock data Day	Enter Day (01 to 31) as a 2 digit BCD.
+6	0 to 7	Clock data Second	Enter Second (00 to 59) as a 2 digit BCD.
	8 to 15	Clock data Minute	Enter Minute (00 to 59) as a 2 digit BCD.
+7	0 to 14	Reserved	Enter 0 in the reserved area.
	15	Update	Write 1 to this bit to write the entered data (address+4 to +6, bits 0 to 15) to the Touch internal clock data.



When the value of the update bit (address+7, bit 15) becomes 1, the clock data is updated as a whole. Year, month, day, hour, minute, and second cannot be set individually.

System Area 4

This area reads the Touch internal clock data in one minute intervals.

Address	Bit	Function	Description
+8	0 to 7	Clock data Month	These bits store the current Month (01 to 12) value as a 2 digit BCD.
	8 to 15	Clock data Year	These bits store the current Year (00 to 99) value as a 2 digit BCD.
+9	0 to 7	Clock data Hour	These bits store the current Hour (00 to 23) value as a 2 digit BCD.
	8 to 15	Clock data Day	These bits store the current Day (01 to 31) value as a 2 digit BCD.
+10	0 to 7	Reserved	
	8 to 15	Clock data Minute	These bits store the current Touch internal clock data Minute (00 to 59).
+11	0 to 3	Clock data Day of Week	These bits store the current Day of Week value as a 2 digit BCD. 00: Sunday 01: Monday 02: Tuesday 03: Wednesday 04: Thursday 05: Friday 06: Saturday
	4 to 15	Reserved	

3.2 Communication Interface Tab

The **Communication Interface** tab is used to configure the functions used by the Touch communication interfaces.

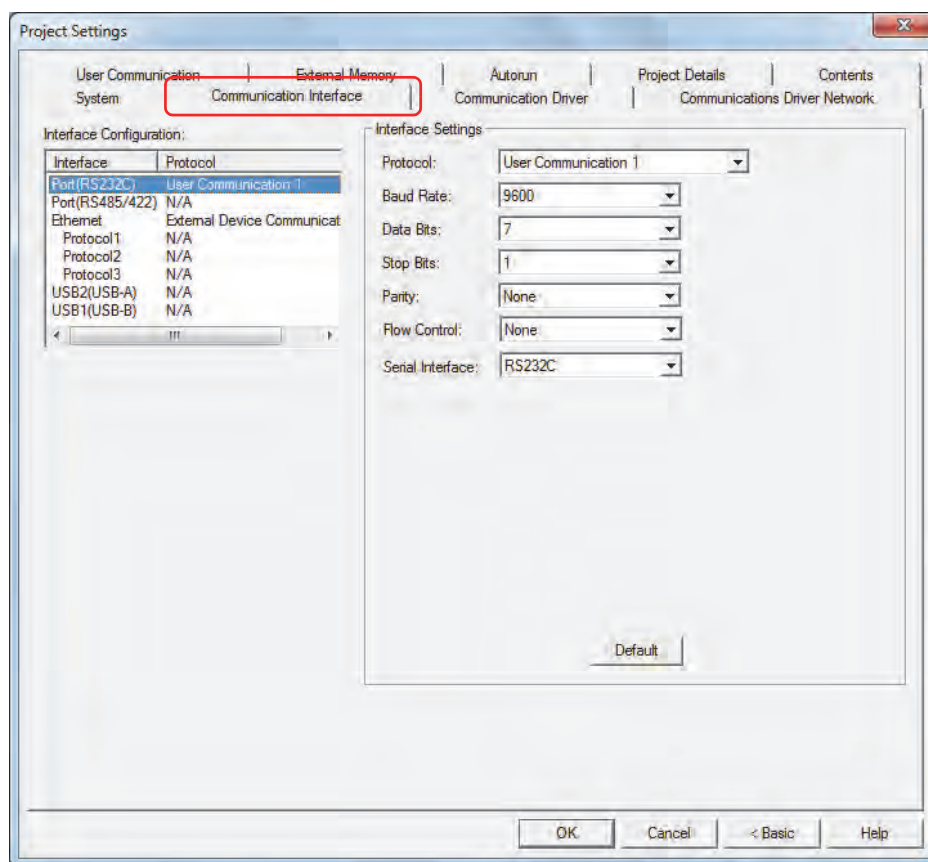

■ Interface Configuration

It displays the communication interfaces and Protocols to use. The settings in the **Interface Settings** changes according to the selected item from this list. The supported Protocols for each communication interface are as follows.

Item	Communication Interface		Protocol				
			External Device Communication	O/I Link Master	O/I Link Slave	User Communication 1 to 3	Maintenance Communication
Port	Serial Interface	RS232C	YES	NO	NO	YES	NO
		RS422/485	YES	YES	YES	YES	NO
Ethernet	Ethernet Interface		YES	NO	NO	YES	YES
USB2	USB Interface TypeA		NO	NO	NO	YES	NO
USB1	USB Interface Mini-B		NO	NO	NO	NO	YES

Functions Available with the Serial Interface

The following functions can be used with the serial interface.

- Barcode reader connection
☞ Refer to Chapter 22 “5 User Communication” on page 22-7.

Functions Available with the Ethernet Interface

The following functions can be used with the Ethernet interface.

- Online
☞ Refer to Chapter 23 “Online Function” on page 23-1.
- Debug
☞ Refer to Chapter 24 “Monitor Function” on page 24-1.

Functions Available with the USB Interface

The following functions can be used with a USB interface.

- Online
☞ Refer to Chapter 23 “Online Function” on page 23-1.
- Debug
☞ Refer to Chapter 24 “Monitor Function” on page 24-1.
- Barcode reader connection
☞ Refer to Chapter 22 “5 User Communication” on page 22-7.

■ Interface Settings

The items that can be configured vary based on the communication interface selected under **Interface Configuration**.

When Port is selected under Interface Configuration

Protocol:	Selects the Protocol to use with the serial interface (RS232C) from the following. N/A, External Device Communication, User Communication 1, User Communication 2, User Communication 3
	Selects the protocol to use with the serial interface (RS422/485) from the following. N/A, External Device Communication, O/I Link Master, O/I Link Slave, User Communication 1, User Communication 2, User Communication 3 This communication interface is not used when N/A is selected.
Baud Rate:	Selects the communication speed with the external device from the following. 1200, 2400, 4800, 9600, 19200, 38400, 57600, 115200, 187500 The baud rate that can be configured varies based on Protocol .
Data Bits:	Selects the data length as 7 or 8 . This option can only be configured when External Device Communication, User Communication 1, User Communication 2, or User Communication 3 is selected for Protocol .
Stop Bits:	Selects the stop bits as 1 or 2 . This option can only be configured when External Device Communication, User Communication 1, User Communication 2, or User Communication 3 is selected for Protocol .
Parity:	Selects the parity from the following. None, Odd, Even This option can only be configured when External Device Communication, User Communication 1, User Communication 2, or User Communication 3 is selected for Protocol .
Flow Control:	Selects the flow control method as None or ER according to the external device being used. This option can only be configured when External Device Communication is selected for Protocol .
Serial Interface:	Selects the standard for the serial interface to use from the following. RS232C, RS422/485 2-wire, RS422/485 4-wire RS422/485 4-wire can only be configured when User Communication 1, User Communication 2, or User Communication 3 is selected for Protocol .

When Ethernet is selected under Interface Configuration

Example: To communicate with two Touchs and a computer via Ethernet

Set Touch A, Touch B, and the computer all to the same values: subnet mask **255.255.255.0**, default gateway **192.168.0.24**.

Set the IP addresses to values that do not conflict: Touch A IP address **192.168.0.1**, Touch B IP address **192.168.0.2**, computer IP address **192.168.0.3**.

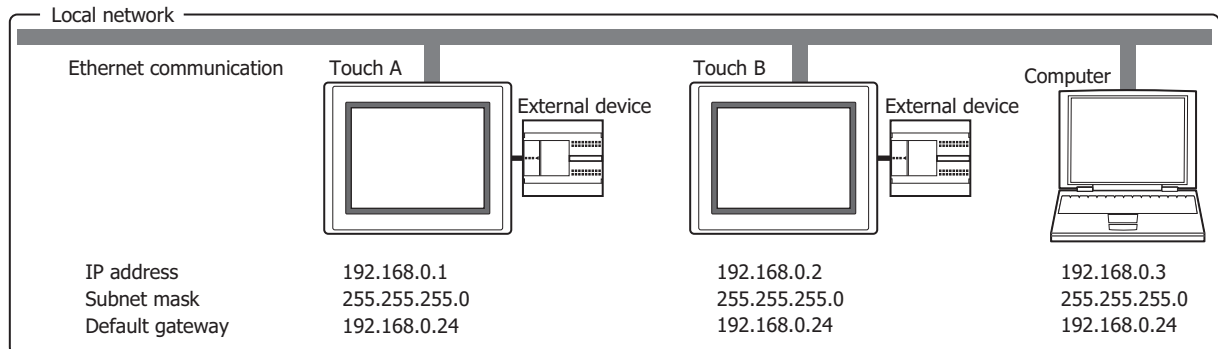

- Set the IP address, subnet mask, and default gateway according to the local network environment being used. When **Automatically obtain the IP address** is selected, the network settings are automatically assigned from the DHCP server on the local network environment being used.
- Settings assigned from the DHCP server can be checked on the Top Page in the System Mode.
- When **Automatically obtain the IP address** is selected, it may take some time to acquire the network settings. If the download fails, increase the timeout time on the **Home** tab, in the **Project** group, in **Comm.Setup**. For details, refer to Chapter 23 "1.3 Change Communication Settings" on page 23-5.

Protocol:

N/A or External Device Communication. Varies based on the **Communication Driver** selected for **Protocol**.

Automatically obtain the IP address (DHCP): Automatically sets the network when connected to a network.

Use the following IP address:

Manually specifies the IP address, subnet mask, and default gateway.

IP Address: Specifies the IP address. (Default: 0.0.0.0)
The format is "xxx.xxx.xxx.xxx". "xxx" stands for a numeric value from 0 to 255.
When connecting multiple devices to the same network, make sure to assign each device a unique IP address.

Subnet Mask: Specifies the subnet mask. (Default: 0.0.0.0)
The format is "xxx.xxx.xxx.xxx". "xxx" stands for a numeric value from 0 to 255.
This value must be the same for all devices.

Default Gateway: Specifies the default gateway. (Default: 0.0.0.0)
The format is "xxx.xxx.xxx.xxx". "xxx" stands for a numeric value from 0 to 255.
Set this value when using a router. Leave the value blank when not required.

Forbid Maintenance Communication:

Select this check box to prohibit maintenance communication via Ethernet communication.



About Networking Terminology

- IP Address:** The number allocated to identify devices connected to an IP network such as the Internet or an intranet. The IP address is the address of each individual device on a network.
- Subnet Mask:** The subnet mask is used to indicate the position of the division between the network address portion and the host address portion of an IP address.
- Default Gateway:** The device such as a computer or a router that represents the gateway used when accessing devices outside the network to which the device belongs.

When Protocol1, Protocol2, or Protocol3 is selected for Ethernet under Interface Configuration

Protocol: Selects the user communication to configure for the selected Protocol from the following.

User Communication 1, User Communication 2, User Communication 3

Operation Mode:

Selects the operation mode when performing user communication with the Ethernet interface.

TCP Client: The Touch operates as a TCP client and the external device operates as a TCP server. The Touch connects to the TCP server and sends and receives data.

TCP Server: The Touch operates as a TCP server and the external device operates as a TCP client. The Touch creates a listening port as a TCP server and waits for connections from TCP clients. After a connection, it sends and receives data with the TCP client.

Target: Configures the IP address and port number for the external device.

These options can only be configured when **TCP Client** is selected for **Operation Mode**.

IP Address: Specifies the IP address for the target.

The format is "xxx.xxx.xxx.xxx". "xxx" stands for a numeric value from 0 to 255.

When connecting multiple devices to the same network, make sure to assign each device a unique IP address.

Port No.: Specifies the port number for the target (0 to 65535).

Change IP Address and Port Number by Device:

Select this check box and specify a word device to change the target's IP address and port number during operation. You can only specify an internal device. During the start of operation, the Touch writes the values configured by **IP Address** and **Port No.** to this device. After the start of operation, the value of device is read and the target is changed.

Click to display the Device Address Settings dialog box. For the device address configuration procedure, refer to Chapter 2 "5.1 Device Address Settings" on page 2-61.

Example: When **IP Address** is set to 192.168.1.1, **Port No.** is 2105, and the device is LDR100

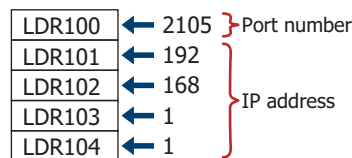

Touch: Configures the Touch listening port number.

These options can only be configured when **TCP Server** is selected for **Operation Mode**.

Port No. Specifies the Touch listening port number (0 to 65535).

The port numbers that cannot be used are as follows.

- Port numbers already used by the Touch: port number 2537 (for maintenance communication), 2538 (for pass-through), 2101 (for FC4A direct connection pass-through)
- When **MODBUS/TCP Server** is selected for **Communication Driver**, **Port Number** on the displayed **Communication Driver Extension** tab



- The connection status for TCP clients and the TCP server can be checked with the value of the HMI Special Data Registers (LSD). The connection is disconnected when 0. The connection is connected when 1.

LSD67-0: Connection status for User Communication 1 set to Ethernet interface

LSD67-1: Connection status for User Communication 2 set to Ethernet interface

LSD67-2: Connection status for User Communication 3 set to Ethernet interface

- To forcibly disconnect the connection with TCP clients and the TCP server, set the value of the HMI Special Data Registers (LSD) from 0 to 1.

LSD68-0: User Communication 1 set to Ethernet interface

LSD68-1: User Communication 2 set to Ethernet interface

LSD68-2: User Communication 3 set to Ethernet interface



- For TCP client and TCP server, make a 1:1 connection between the Touch and the external device for one user communication setting.
- When the **Change IP Address and Port Number by Device** check box is selected, the changed IP address and port number are reflected when data is next sent.

When USB2 is selected under Interface Configuration

Protocol: Selects the Protocol used by the USB interface Type A from the following.

N/A, User Communication 1, User Communication 2, User Communication 3

This communication interface is not used when **N/A** is selected.

When USB1 is selected under Interface Configuration

Protocol: **N/A** is displayed.

This communication interface is used for maintenance communication.

3.3 Communication Driver Tab

The **Communication Driver** tab is used to configure the communication driver for the external device configured in the current project data.

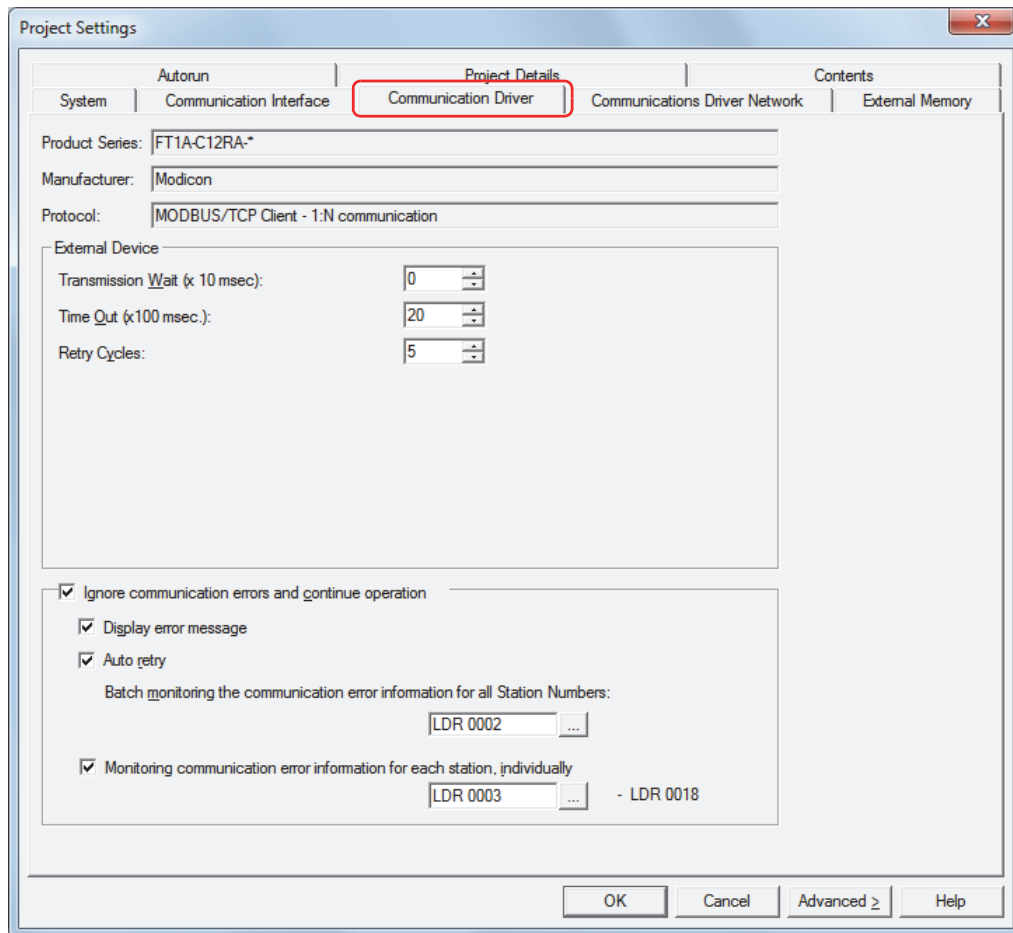

- **Product Series**

Shows the Touch model configured in the current project data.

- **Manufacturer**

Shows the external device manufacturer configured in the current project data.

- **Protocol**

Shows the communication driver name configured in the current project data.

- **External Device**

These options configure the communication driver to use. For details, refer to the "External Device Setup Manual".

Transmission Wait (x 10 msec): Specifies the transmission interval for communication commands (0 to 255).

Time Out (x 100 msec): Specifies the time to wait for a response from the external device (1 to 255).

Retry Cycles: Specifies the number of times to execute a reconnection when the Touch cannot communicate with the external device. When the number of reconnect attempts reaches the number of times set here, a communication error is displayed.

■ Ignore communication errors and continue operation

Select this check box to continue Touch operation even when a communication error occurs.

This option is only displayed when the communication driver **Connection** is **1:N Communication**.

Display error message: Select this check box to display an error message (communication error) when a communication error occurs and operation continues. **Ack** is displayed on the error message (communication error).

When the **Ignore communication errors and continue operation** check box is cleared, **Ack** is not displayed on the error message.

Auto retry: Select this check box to automatically retry communication from the Touch to the station number where the communication error occurred when a communication error occurs and operation continues.

All other communication stops while retrying.



To manually retry communication, clear the **Auto retry** check box.

To retry all station numbers, write 1 in bit 1 (initialize) of the device address configured by **Batch monitoring the communication error information for all Station Numbers**.

To individually retry communication, write 1 in bit 0 (connection setting) of the device address configured by **Monitoring communication error information for each station number, individually**.

Batch monitoring the communication error information for all Station Numbers:

Specifies the device that stores communication error information for all station numbers. Only the HMI devices can be configured for this option.

Click  to display the Device Address Settings dialog box. For the device address configuration procedure, refer to Chapter 2 "5.1 Device Address Settings" on page 2-61.

The information stored as error information is as follows. For details, refer to the "External Device Setup Manual".

- Initialization
- Conditions under which the error occurred
- Read error log
- Write error log

Monitoring communication error information for each station number, individually:

Specifies the device that stores communication error information for each station number. Only the HMI devices can be configured for this option.

Click  to display the Device Address Settings dialog box. For the device address configuration procedure, refer to Chapter 2 "5.1 Device Address Settings" on page 2-61.

This error information utilizes a maximum of 256 devices. Use caution so that the used addresses do not overlap with other addresses.

The information stored as error information is as follows. For details, refer to the "External Device Setup Manual".

- Connection settings
- Conditions under which the error occurred
- Read error log
- Write error log

3.4 Communication Driver Network Tab

The **Communication Driver Network** tab is used to configure the information for external devices connected by Ethernet communication. This tab is displayed when a communication driver is selected that supports Ethernet communication.

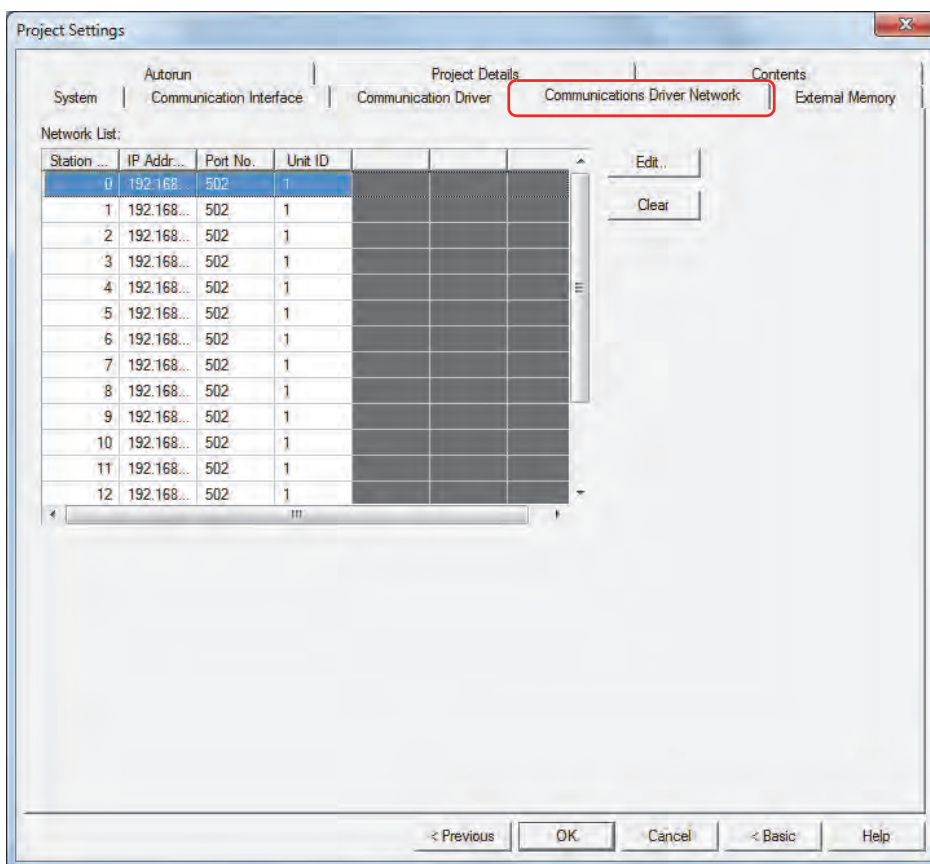

■ Network List

Edits the settings for the external devices.

Station No.: Shows the station number of external device. Double clicking the cell displays the Communication Driver Network Settings dialog box.

IP Address: Shows the IP address of the external device. (Default: 192.168.0.1)

Double clicking the cell allows you to specify the external device's IP address.

The format is "xxx.xxx.xxx.xxx". "xxx" stands for a numeric value from 0 to 255.

When connecting multiple devices to the same network, make sure to assign each device a unique IP address.

Port No.: Shows the port number of external device. (Default: 2101)

Double clicking the cell allows you to specify the external device's port number (0 to 65535).

■ Edit

Configures the IP address and port number for the selected station number. Select a station number, and then click this button to display the Communication Driver Network Settings dialog box.

■ Clear

Returns the settings for the selected station number to the defaults.



You can change the IP address of the station numbers for the external devices using the System Screen. In the Top Page in the System Screen, press **Initial Setting, Comm. I/F, Ext. IP Address** in order.

● Communications Driver Network Settings Dialog Box

To communicate with an external device by using Ethernet communication, specify the Ethernet settings (IP address, port number) for the destination external device. The settings other than **IP Address** and **Port** vary based on the external device. For details, refer to the External Device Setup Manual.

Example: **MODBUS/TCP Client** is selected for **Communication Driver**

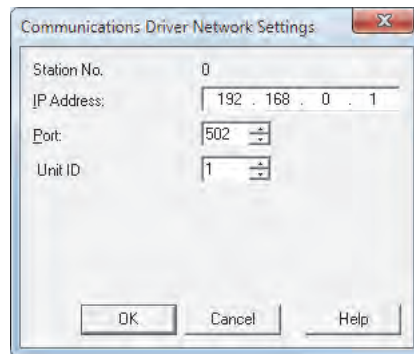

■ IP Address

Specifies the IP address of the destination external device.

The format is "xxx.xxx.xxx.xxx". "xxx" stands for a numeric value from 0 to 255.

When connecting multiple devices to the same network, make sure to assign each device a unique IP address.

■ Port

Specifies the port number (0 to 65,535) of the destination external device.

3.5 Communication Driver Extension Tab

The **Communication Driver Extension** tab is used to configure the communication driver extension settings. These settings vary based on the external device. This tab is displayed when communication driver extension settings are required. For details, refer to the "External Device Setup Manual".

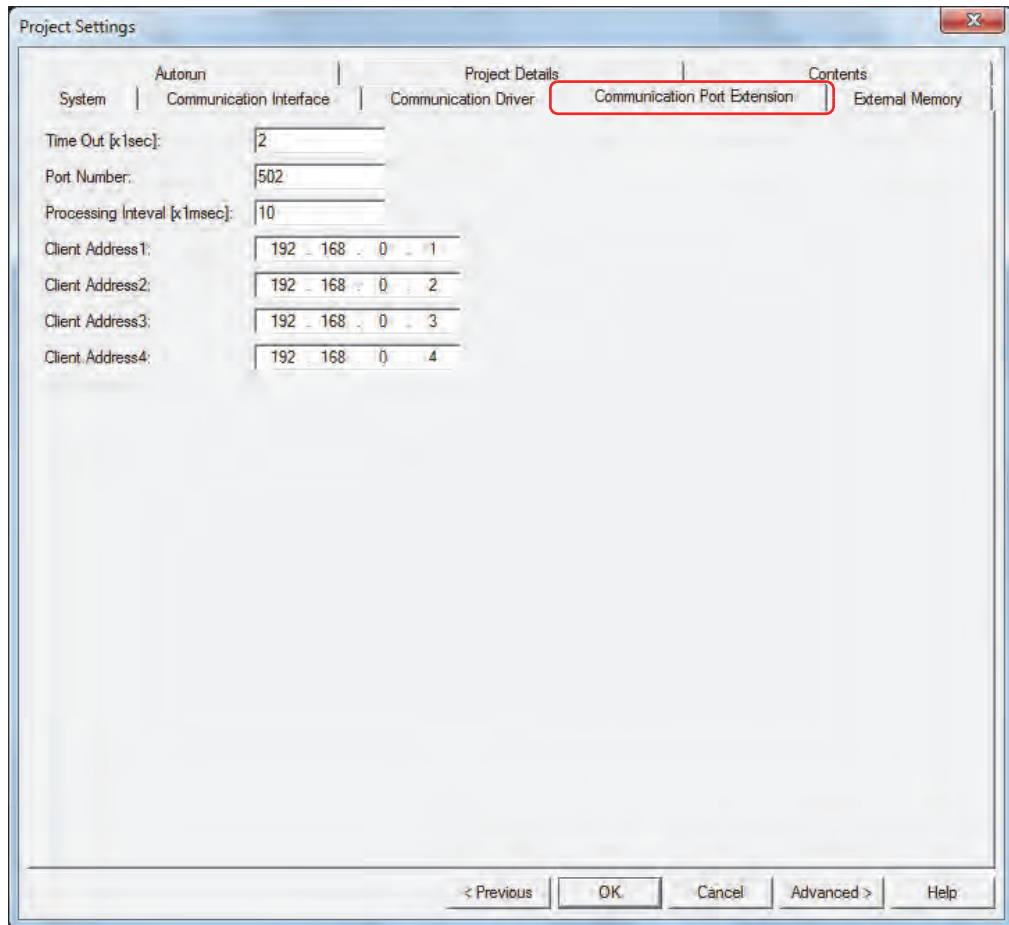

The screenshot shows the "Project Settings" dialog box with the "Communication Port Extension" tab selected. The dialog box has a title bar with "Project Settings" and a close button. The main area is divided into several sections: "System", "Autonun", "Project Details", and "Contents". The "Communication Port Extension" tab is highlighted with a red box. The settings are as follows:

System	Autonun	Project Details	Contents
System	Communication Interface	Communication Driver	Communication Port Extension

Time Out [x1sec]:	2
Port Number:	502
Processing Interval [x1msec]:	10
Client Address1:	192 - 168 - 0 - 1
Client Address2:	192 - 168 - 0 - 2
Client Address3:	192 - 168 - 0 - 3
Client Address4:	192 - 168 - 0 - 4

At the bottom of the dialog box, there are five buttons: "< Previous", "OK", "Cancel", "Advanced >", and "Help".

3.6 O/I Link Tab

The **O/I Link** tab configures the slave stations to connect to when the Touch is used as the O/I Link Communication master. It configures the O/I Link station when the Touch is used as a slave. For details, refer to Chapter 22 “2 O/I Link Communication” on page 22-3. These options can only be configured when **O/I Link Master** or **O/I Link Slave** is selected for **Protocol** under **Interface Settings** on the **Communication Interface** tab.

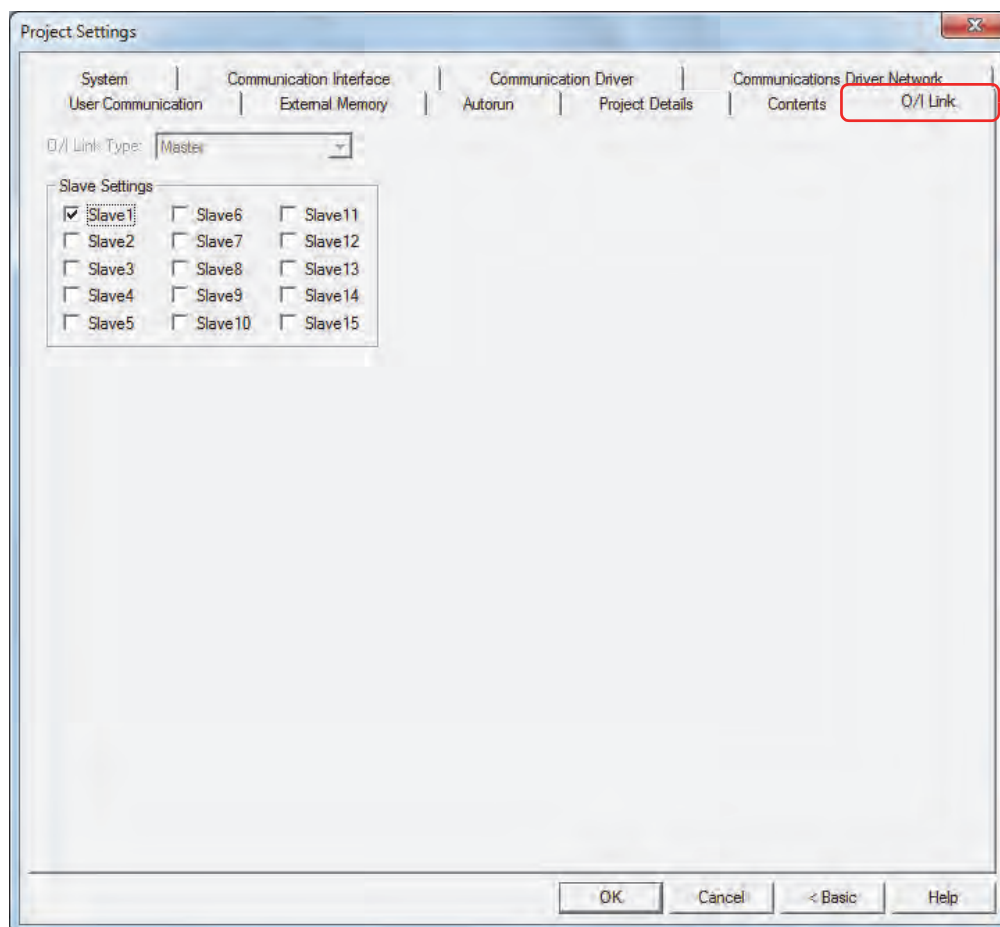

■ O/I Link Type

Selects the slave station (Slave1 to Slave15).

This option can only be configured when **O/I Link Slave** is selected for **Protocol** under **Interface Settings** on the **Communication Interface** tab.

■ Slave Settings

Select the check boxes for the slave stations to connect to.

This option can only be configured when **O/I Link Master** is selected for **Protocol** under **Interface Settings** on the **Communication Interface** tab.



The slave stations to connect to when the Touch is used as an O/I Link Communication Master are enabled after the project is downloaded. The slave station number when the Touch is used as a slave is also enabled after the project is downloaded.

3.7 User Communication Tab

The **User Communication** tab is used to configure communication with external devices such as barcode readers. For details, refer to Chapter 22 “5 User Communication” on page 22-7. This option can only be configured when **User Communication 1**, **User Communication 2**, or **User Communication 3** is selected for **Protocol** under **Interface Settings** on the **Communication Interface** tab.

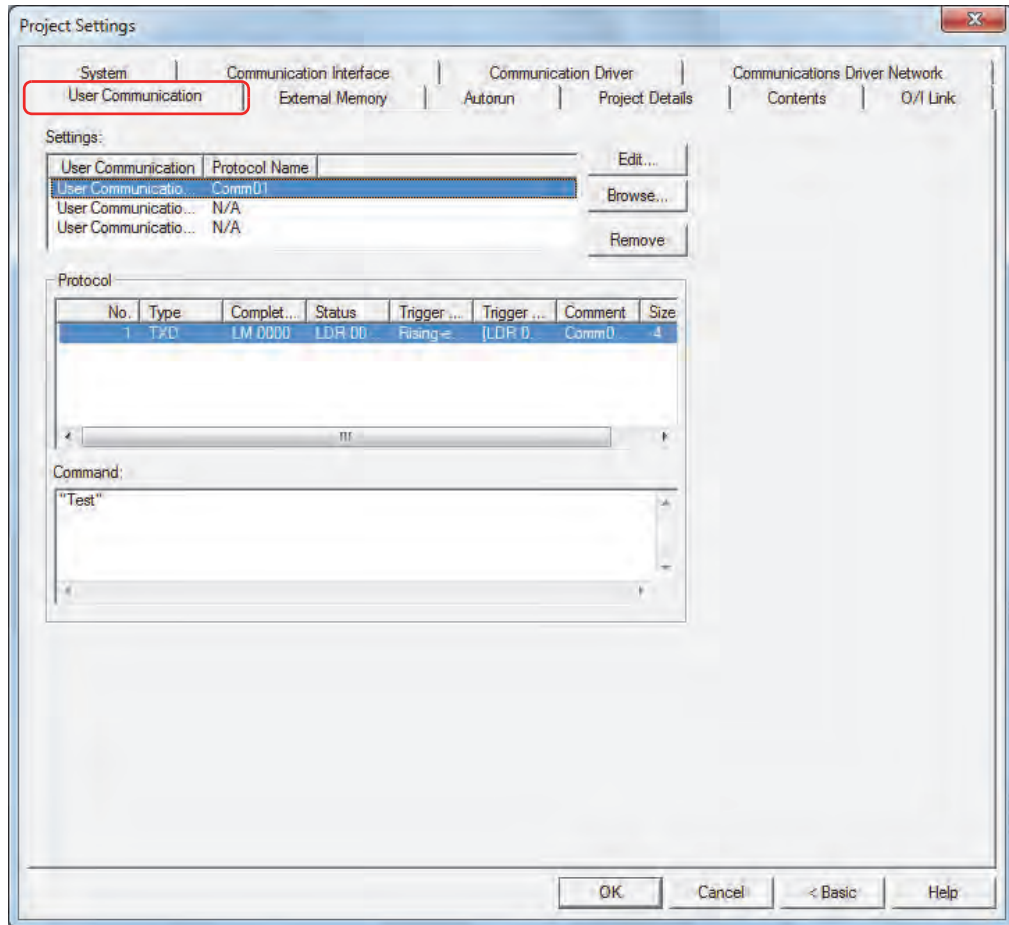

■ Settings

Edits the user communication settings. You can use up to three user communication settings.

User Communication: Shows the user communication number.

Protocol Name: Shows **Protocol Name** configured in the User Communication Protocol Settings dialog box.

■ Edit

Registers or changes the selected user communication settings. Select a user communication number, and then click this button to display the User Communication Protocol Settings dialog box.

■ Browse

Selects a Protocol to use as user communication with Protocol Manager. Click this button to display Protocol Manager.

■ Remove

Removes the Protocol selected under User Communication from the list.

■ Protocol

Shows the Protocol defined as the selected user communication.

No.:	Shows the number for managing the Protocol settings. Double clicking the cell displays the Command Settings dialog box.
Type:	Shows the type of command. Double clicking the cell displays the Command Settings dialog box.
Completed:	Shows the send or receive complete report device. Double clicking the cell displays the Command Settings dialog box.
Status:	Shows the destination device for the send or receive size and error information. Double clicking the cell displays the Command Settings dialog box.
Trigger Type:	Shows the trigger type to execute the script. Double clicking the cell displays the Command Settings dialog box.
Trigger Condition:	The displayed content varies based on Trigger Type . Rising-edge, Falling-edge, While ON, or While OFF: Shows the bit device that is the condition. Double clicking the cell displays the Command Settings dialog box. While satisfying the condition or Satisfy the condition: Shows the conditional expression. Fixed Period: Shows the period.
Comment:	Shows the command comment. Double clicking the cell displays the Command Settings dialog box.
Size:	Shows the command size in bytes. Double clicking the cell displays the Command Settings dialog box.

■ Command

Shows the command settings for the selected Protocol. Double clicking the cell displays the Data Settings dialog box.

3.8 External Memory Tab

The **External Memory** tab is used to configure the destination folder on the external memory inserted in the Touch.

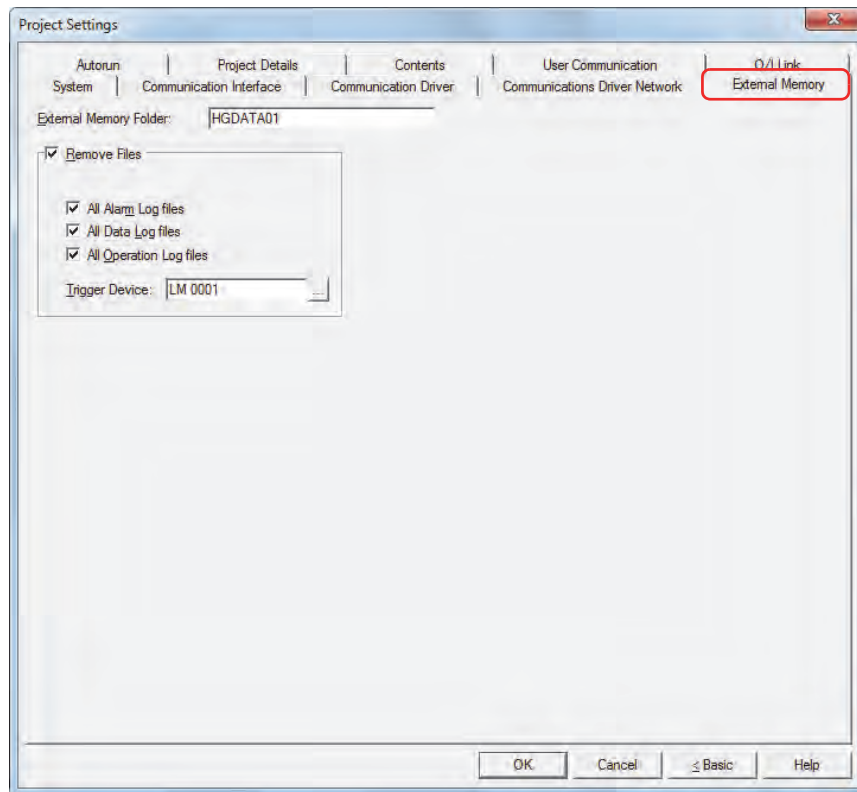

■ External Memory Folder

Enter the folder name for the folder in the external memory to use on the Touch within 8 alphanumeric characters using upper-case alphabetic characters (A to Z) and numbers (0 to 9). The default External Memory Folder name is "HGDATA01".

All the data sampled with the log functions is saved in this External Memory Folder. For details on the external memory, refer to Chapter 26 "1 USB Flash Drives" on page 26-1.



- You cannot use the following characters in the folder name.
 \ / : ; * ? " < > |
- After operation starts, the folders created in the External Memory Folder and the file names cannot be changed.

■ Remove Files

Select this check box to erase the files saved in the External Memory Folder.

- | | |
|--------------------------|--|
| All Alarm Log files: | Select this check box to erase all the Alarm Log data saved in folder. The folder name is "ALARMLOG". |
| All Data Log files: | Select this check box to erase all the Data Log data saved in folder. The folder name is "DATALOG". |
| All Operation Log files: | Select this check box to erase all the Operation Log data saved in all folders. The folder name is "OPERATIONLOG". |
| Trigger Device: | Specifies the bit device or bit of the word device to serve as condition to delete the files. Click <input type="button" value="..."/> to display the Device Address Settings dialog box. For the device address configuration procedure, refer to Chapter 2 "5.1 Device Address Settings" on page 2-61. |

3.9 Autorun Tab

The **Autorun** tab is used to configure the USB flash drive autorun functions when inserted in the Touch. For details on USB flash drives, refer to Chapter 26 "1 USB Flash Drives" on page 26-1.

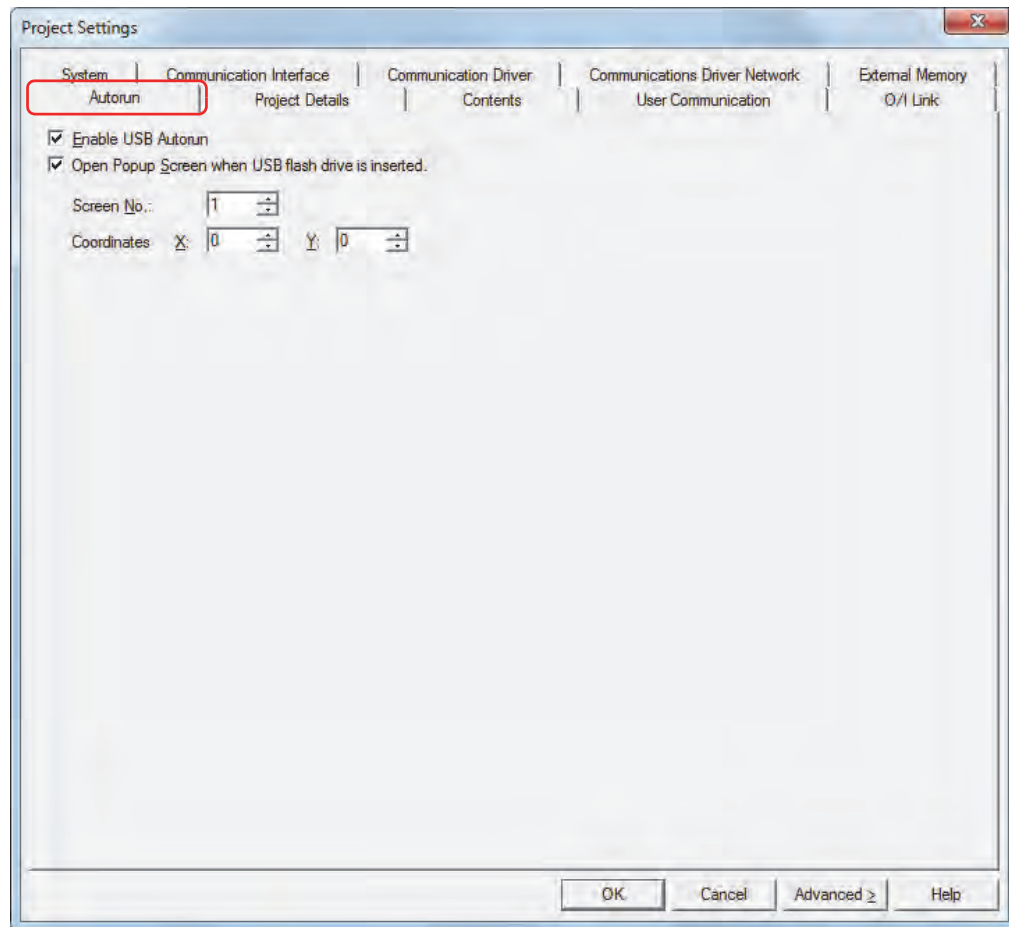

■ Enable USB Autorun

Select this check box to enable the USB Autorun function.

The USB Autorun function automatically displays a menu screen from which the user can execute predefined commands when a USB flash drive is inserted in the Touch.

■ Open Popup Screen when USB flash drive is inserted

Select this check box to display a Popup Screen when a USB flash drive is inserted in the Touch.

Screen No.: Specifies the Popup Screen number (1 to 3015) to display when a USB flash drive is inserted in the Touch.

Coordinates X, Y: Specifies the coordinates to display the Popup Screen.
With the upper-left corner of the screen as the origin, the X and Y coordinates are the upper-left corner of the Popup Screen.

The units and range for the display coordinates are as follows.

Specify the coordinates in 1 dot units.

X: 0 to (Base Screen horizontal size - 1)

Y: 0 to (Base Screen vertical size - 1)

3.10 Project Details Tab

The **Project Details** tab displays and configures project data information.

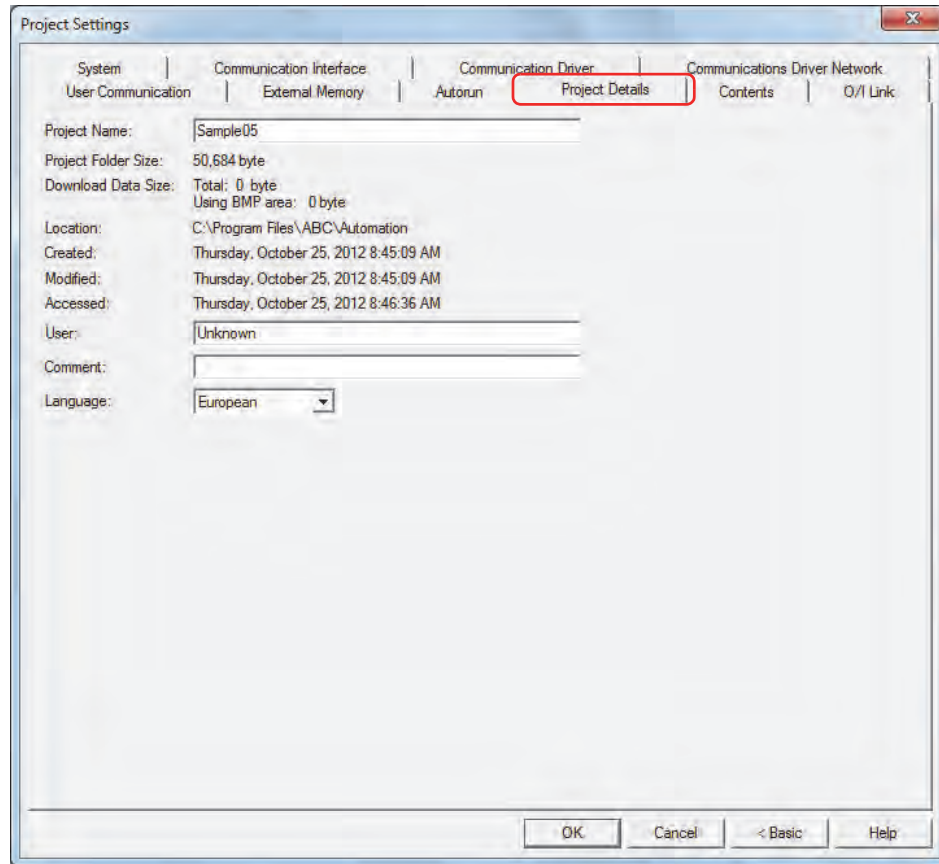

■ Project Name

Shows the current project name. To change the project name, enter a new project name. The maximum number is 50 characters.



You cannot use the following characters in the project name.

\ / : , ; * ? " < > |

■ Project Folder Size

Shows the total size of the current project data.

■ Download Data Size

Shows the total size of the data and the total size of only the image files when the current project data is downloaded.

■ Location

Shows the save location for the current project data.

■ Created

Shows the date and time the current project data was created.

■ Modified

Shows the date and time the current project data was last saved.

■ Accessed

Shows the date and time the current project data was opened.

■ User

Enter the name of the creator. The maximum number is 40 characters.

■ Comment

Enter a comment for the project data. The maximum number is 40 characters.

■ Language

Selects the language to use for the system information from the following. This option is also reflected in the project name displayed in the system information on the Touch's System Screen.

European, Japanese, Chinese, Taiwanese, Korean, Central European, Baltic, Cyrillic

The display type for dates and times varies based on the selected language.

Japanese: YYYY/MM/DD HH:MM:SS

European, Chinese, Taiwanese, Korean, Central European, Baltic, Cyrillic: MM/DD/YYYY HH:MM:SS

3.11 Contents Tab

The **Contents** tab is used to enter a comment for the project data.

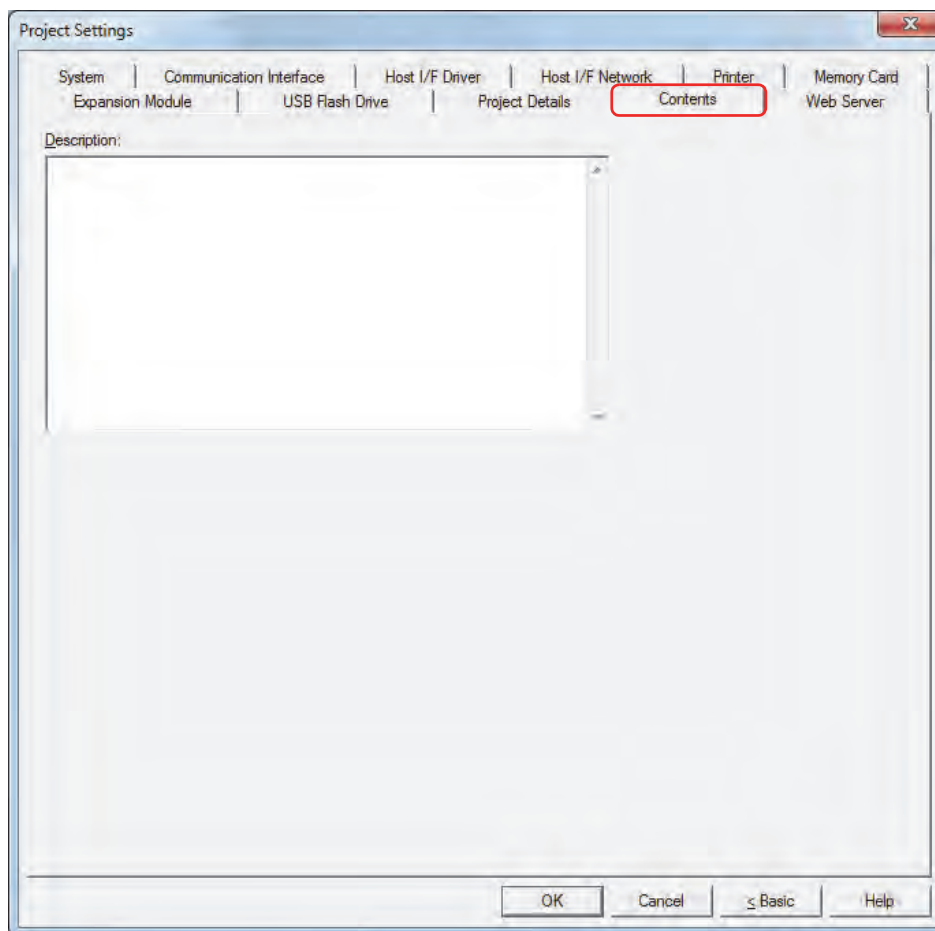

■ Description

Enter a comment for the project data. The maximum number is 511 characters. A newline is counted as two characters.



The content in **Description** is erased when the project is uploaded.

4 Special Functions

This chapter describes the Touch special functions, how to configure them, and examples of their use.

● Function List

Function name	Overview	Setup location
Stop input	The ladder program or FBD program operation can be stopped with a specified input.	Function area settings
Reset input	The values of the control devices can be cleared with a specified input.	
Run/stop selection at memory backup error	Whether to start or stop the ladder program or FBD program operation when the Touch is powered up after the "keep" data in the RAM has been lost can be specified.	
Run/stop selection at power up	Whether to start or stop the ladder program or FBD program operation regardless of the M8000 status when the Touch is powered up can be specified.	
Keep and clear devices	Whether to clear or keep the device values, such as counter current values, when the ladder program operation starts running can be specified.	
High-speed counter	The high-speed counters can be used to count input pulses from rotary encoders or proximity switches regardless of the scan time.	
Catch input	The catch input can be used to receive short pulses from sensors regardless of the scan time.	
Interrupt input	When a quick response to an external input is required, such as in positioning control, the interrupt input can call a subroutine to execute an interrupt program.	
Frequency measurement	The pulse frequency of input signals to input terminals can be counted regardless of the scan time.	
Input filter	The input filter rejects short input pulses when the Touch is used with input signals containing noises.	
Analog input	Analog voltage inputs, such as inputs from pressure sensors, can be read and stored in special data registers as digital values.	
Timer interrupt	When executing the same program repeatedly regardless of the scan time is required, the timer interrupt can call a subroutine to execute an interrupt program at specified time interval.	
Analog output	Analog values of voltage and current can be output.	
Analog cartridge	Analog signals can be received or analog values can be output with the analog cartridge attached to the Touch (transistor output type).	
Ladder Monitor	Settings for running the Ladder Monitor on the LCD	
Watchdog timer settings	The watchdog timer monitors the operation and the watchdog time preset value can be changed.	
Daylight savings time	The internal clock can automatically be adjusted according to the configured daylight saving time period.	
Remote I/O	The number of inputs and outputs can be expanded by connecting the SmartAXIS Pro/Lite as remote I/O slave.	
Clock function	The Touch can operate according to the current date and time and be used in applications, such as lighting or air conditioning.	Instructions or FB



When the setting of control function is changed, save the project data. If project data is saved on WindO/I-NV3, the setting of control function is also saved.

4.1 Function Area Settings Configuration Procedure

The function area settings are the environment settings for the Touch. The operation of the Touch when powered and communication port settings are configured in **Function Area Settings**.

This section describes the configuration procedure for the Function Area Settings.

- 1 On the WindO/I-NV3 **View** tab, in the **Workspace** group, click  (**Control Function**).
WindLDR starts.

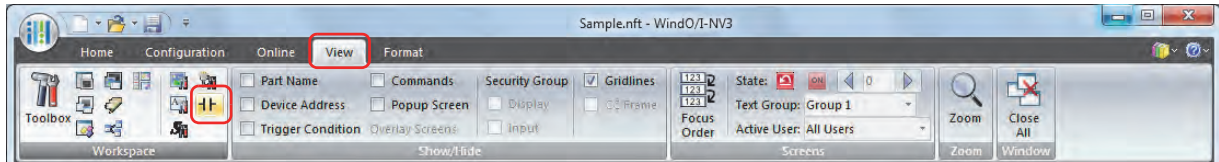

- 2 On the WindLDR **Configuration** tab, in the **Function Area Settings** group, click a button for special functions.
The Function Area Settings dialog box is displayed.

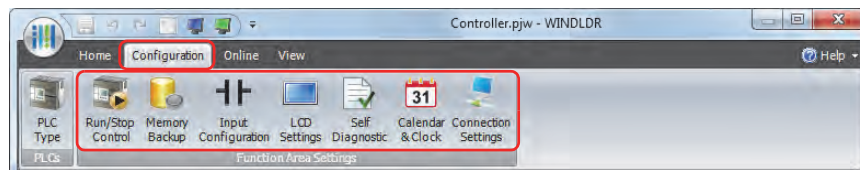

- 3 Change the settings as necessary.

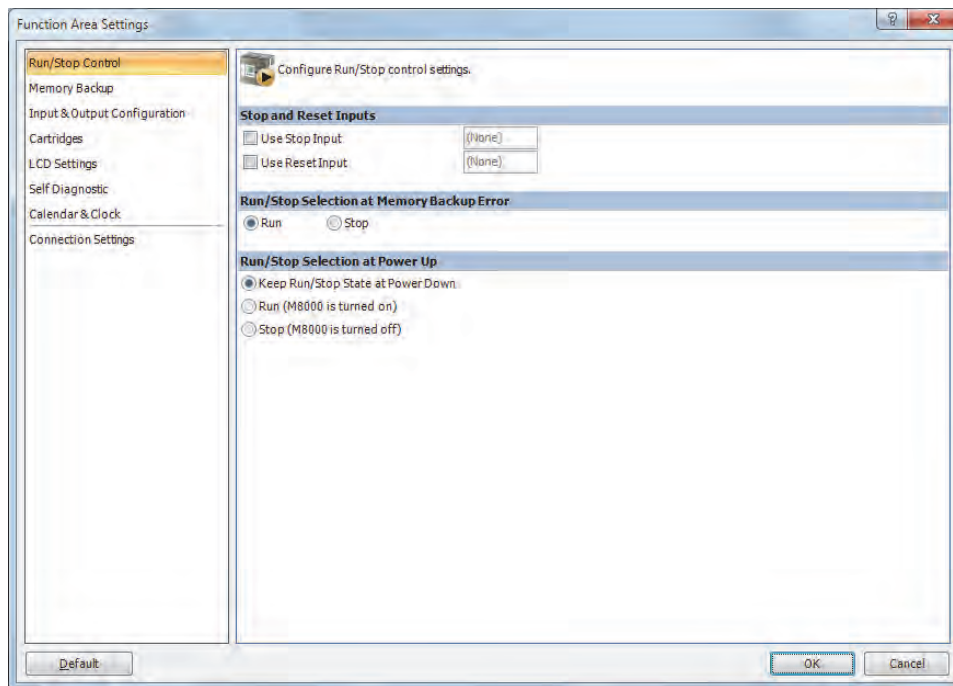

● Function Description

Run/Stop Control	<p>These functions run or stop the ladder program or FBD program when the Touch is turned on, when an error occurs, or when an external input turns on.</p> <ul style="list-style-type: none"> • Stop input • Reset input • Run/stop selection at memory backup error • Run/stop selection at power up
Memory Backup	<p>These functions keep or clear Control devices (the contents of memory) when a ladder program or FBD program starts operation. The values of the following devices can be configured to be kept or cleared.</p> <ul style="list-style-type: none"> • Internal relays • Shift registers • Counters • Data registers
Input & Output Configuration	<p>These options configure the special functions such as the external input filter settings and the high-speed counter.</p> <ul style="list-style-type: none"> • High-speed counter • Catch input • Interrupt input • Frequency measurement • Input filter • Analog input • Timer interrupt • Analog output
Cartridges	<p>Configure the function to use the cartridge of the Touch.</p> <ul style="list-style-type: none"> • Analog cartridge
LCD Settings	<p>Configure the LCD settings for the Touch.</p> <ul style="list-style-type: none"> • Ladder Monitor
Self Diagnostic	<p>These settings configure the watchdog timer that monitors the operating status of the Touch.</p>
Calendar & Clock	<p>The Touch is equipped with an internal clock and its calendar data (year, month, day, day of the week) and clock data (hour, minute, second) which can be used in a ladder program or FBD program. Daylight savings time can also be configured for the internal clock.</p>
Connection Settings	<p>Configure the communication mode for using the remote I/O function with the Touch.</p> <ul style="list-style-type: none"> • Remote I/O Master

4.2 Stop Input

This section describes the function on how a ladder program or FBD program for the Touch can be stopped with external input.

● Function Description

This function stops execution of a ladder program or FBD program for the Touch by means of an external input, such as a control panel switch.

The normal external inputs of the Touch are set as stop inputs.

When a stop input is set to ON, the ladder program or FBD program is stopped during execution. When a stop input is set to OFF, the ladder program or FBD program executes from the top.

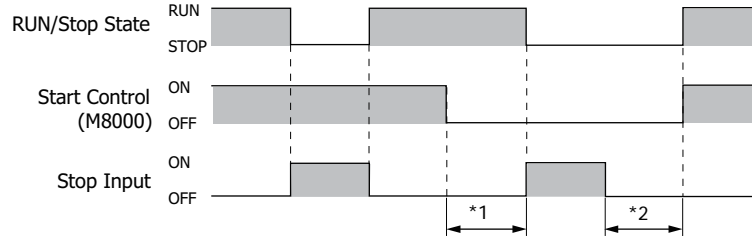

The external inputs that can be set as stop inputs are I0 to I7.



While a reset input is ON, a ladder program or FBD program is stopped. For details of reset inputs, refer to "4.3 Reset Input" on page 3-49.

● Procedure

- 1 On the WindO/I-NV3 **View** tab, in the **Workspace** group, click  (Control Function) .
WindLDR starts.

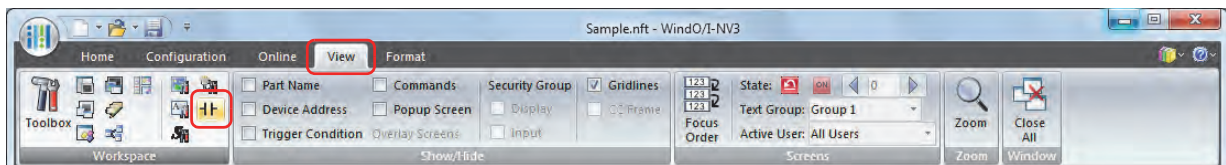

- 2 On the WindLDR **Configuration** tab, in the **Function Area Settings** group, click **Run/Stop Control**.
The Function Area Settings dialog box is displayed.
- 3 Select the **Use Stop Input** check box.

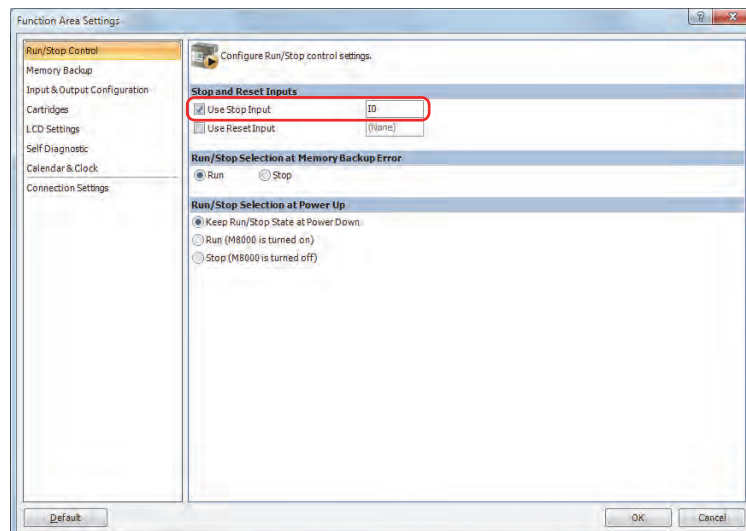

- 4 Designate an external input (ex. I0) as a stop input.
- 5 Click **OK**.

This concludes configuring the settings.

If I0 is set to ON after a ladder program or FBD program is downloaded, these programs will stop.

- *1 Even when M8000 (start control) is OFF, if a stop input is OFF, the Touch will remain in the RUN state.
- *2 Even when a stop input is OFF, since M8000 (start control) is OFF, the program will not go into RUN state.

4.3 Reset Input

This section describes the function for clearing the values of the Touch devices by means of external input.

● Function Description

This function clears execution of the Touch control devices by means of an external input, such as a control panel switch. The normal external inputs of the Touch are set as reset inputs.

If a reset input is ON, the ladder program or FBD program stops during execution and all control devices and general errors are cleared, except for special internal relays and special data registers. When a reset input is set to OFF, the ladder program or FBD program executes from the top.

To set the reset input to OFF and execute the ladder program or FBD program once again, it is necessary that M8000 is ON and that stop inputs are OFF (if a stop input is set).

If these conditions are not satisfied, then even if the reset input is OFF, program execution will remain stopped and the ladder program or FBD program will not execute.

The external inputs that can be set as reset inputs are I0 to I7.

● Procedure

- 1 On the WindO/I-NV3 **View** tab, in the **Workspace** group, click  (Control Function).

WindLDR starts.

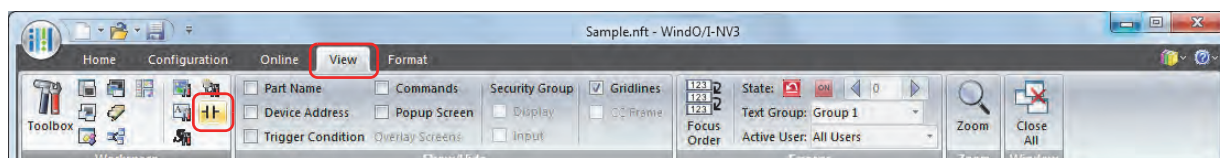

- 2 On the WindLDR **Configuration** tab, in the **Function Area Settings** group, click **Run/Stop Control**.

The Function Area Settings dialog box is displayed.

- 3 Select the **Use Reset Input** check box.

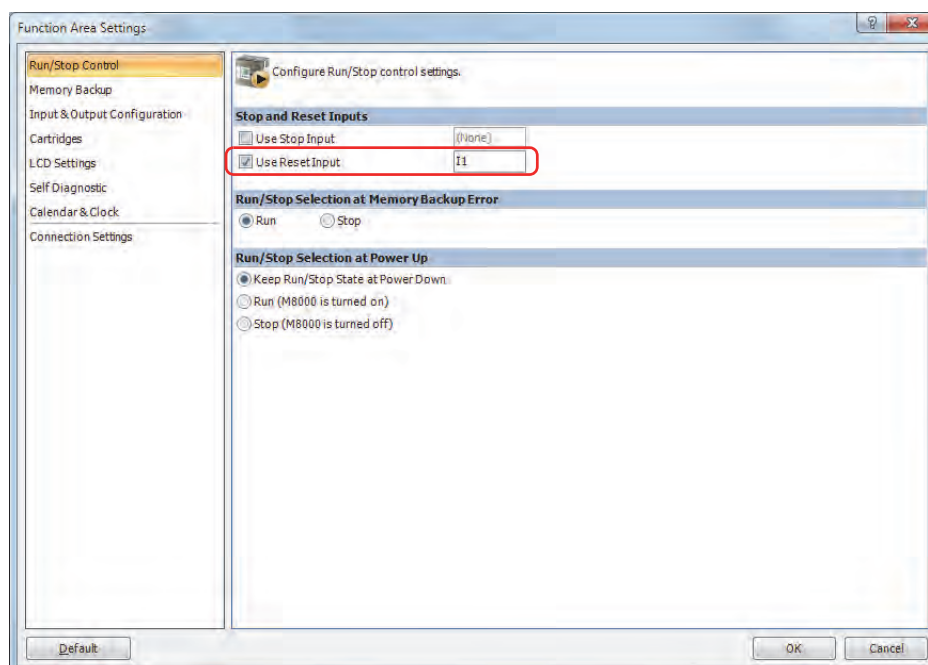

- 4 Designate an external input (ex. I1) as a reset input.

- 5 Click **OK**.

This concludes configuring the settings.

If I1 is set to ON after a ladder program or FBD program is downloaded, these programs will stop and the value of the control device will be cleared.

The state of each data item at the time of RUN, STOP, and Reset are as follows.

Operation	Output	Internal relays, Shift register bits, Counters, and Data register values		Special internal relay	Special data register	Not-maintained data register	Timer current value
		Keep designation range	Clear designation range				
RUN	Program operation	Program operation	Program operation	Program operation	Program operation	Program operation	Program operation
STOP	OFF	Maintained	Maintained	Refer to Chapter 27.	Maintained	Maintained	Maintained
STOP → RUN	Maintained	Maintained	Cleared	Maintained	Maintained	Maintained	Initialized
Reset (when reset input is turned on)	OFF	Cleared	Cleared	Maintained	Maintained	Cleared	Cleared
Power OFF	OFF	Maintained	Maintained	Refer to Chapter 27.	Maintained	Cleared	Cleared

Keep settings and clear settings for the internal relays, shift registers, counters, and data registers of control devices are configured using the **Function Area Settings** tab. For details about keep settings and clear settings, refer to “4.6 Keep and Clear Control Devices” on page 3-53.

4.4 Run/Stop Selection at Memory Backup Error

This section describes the function for setting the state of ladder programs or FBD programs when memory backup error is occurred.

● Function Description

If the Touch is powered OFF and left unused for long periods, resulting in a depleted backup battery, values of devices, current time, and other data retained by the Touch are lost. If power is supplied to the Touch when it has lost this retained data, a memory backup error occurs. The state of the ladder program or FBD program when such a memory backup error occurs can be selected.

If there is any risk of unforeseen actions occurring when the Touch is run while in this state (after memory backup error is occurred), set to **STOP**. If the Touch is always operated regardless of whether a memory backup error occurs, because there is no means to run ladder programs or FBD programs where it is located or for a similar reason, selected to **RUN**.



- Thanks to a lithium-ion battery the RUN/STOP (M8000) state of the Touch immediately before it is powered OFF is retained, so when it is powered ON again, the Touch will operate in accordance with this preserved RUN/STOP state.
- If the Touch is powered ON after this retained data is lost, following a long period of disuse, for example, a memory backup error occurs and the value of special internal relay M8000 (start control) is lost.
- The data backup period is approximately 30 days when the backup battery is fully charged. After the backup period is exceeded, the retained data will be lost from the Touch.
- If a keep data error occurs when **Run/Stop Selection at Memory Backup Error** issues a **STOP** instruction, the Touch stops running. To start operation of the Touch, set the Touch to **RUN** using the Touch. For details, refer to Chapter 12 “Executing and Stopping Ladder Programs or FBD Programs” on page 12-3.
- When a memory backup error occurs, an error code is stored in special data register D8005 (general error code). For details, refer to Chapter 30 “2.1 General Error Codes” on page 30-3.

● Procedure

- 1 On the WindO/I-NV3 **View** tab, in the **Workspace** group, click  (Control Function) .
WindLDR starts.

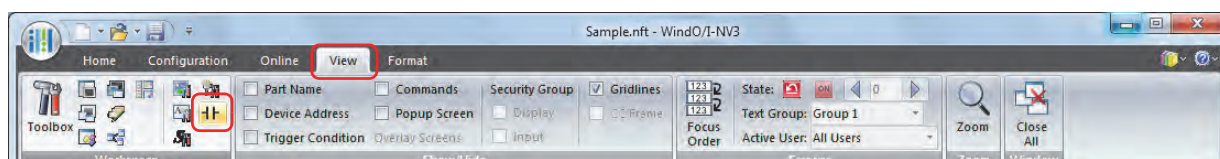

- 2 On the WindLDR **Configuration** tab, in the **Function Area Settings** group, click **Run/Stop Control**.
The Function Area Settings dialog box is displayed.
- 3 Click **Run** under the **Run/Stop Selection at Memory Backup Error**.

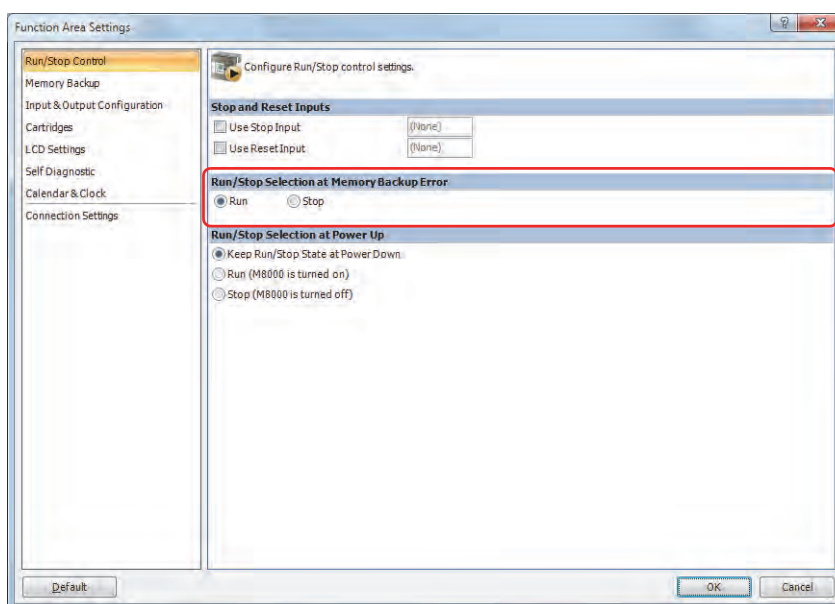

- 4 Click **OK**.
This concludes configuring the settings.

4.5 Run/Stop Selection at Power Up

This section describes the function for selecting the state of ladder programs or FBD programs when the Touch is turned on.

● Feature Description

The state of ladder programs or FBD programs when the Touch is turned on is determined by the value of special internal relay M8000 (start control).

Configuration	Operation
Keep Run/Stop State at Power Down	Starts running the Touch with the ladder program or FBD program in the state at power down when the Touch is powered up.
Run (M8000 is turned on)	Turns ON M8000 and starts running the Touch and the ladder program or FBD program when the Touch is powered up.
Stop (M8000 is turned off)	Turns OFF M8000, starts running the Touch and stops the ladder program or FBD program when the Touch is powered up.



- When the memory backup error occurs, the Touch is started or stopped according to **Run/Stop Selection at Memory Backup Error** regardless of **Run/Stop Selection at Power Up**.
- Stop inputs and reset inputs have a higher priority than **RUN/STOP Selection at Power Up**.

● Procedure

- 1 On the WindO/I-NV3 **View** tab, in the **Workspace** group, click  (Control Function).

WindLDR starts.

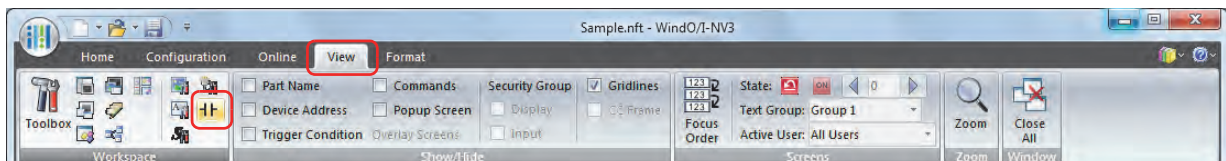

- 2 On the WindLDR **Configuration** tab, in the **Function Area Settings** group, click **Run/Stop Control**.

The Function Area Settings dialog box is displayed.

- 3 Click **Keep Run/Stop State at Power Down**, **Run** or **Stop** under the **Run/Stop Selection at Power Up**.

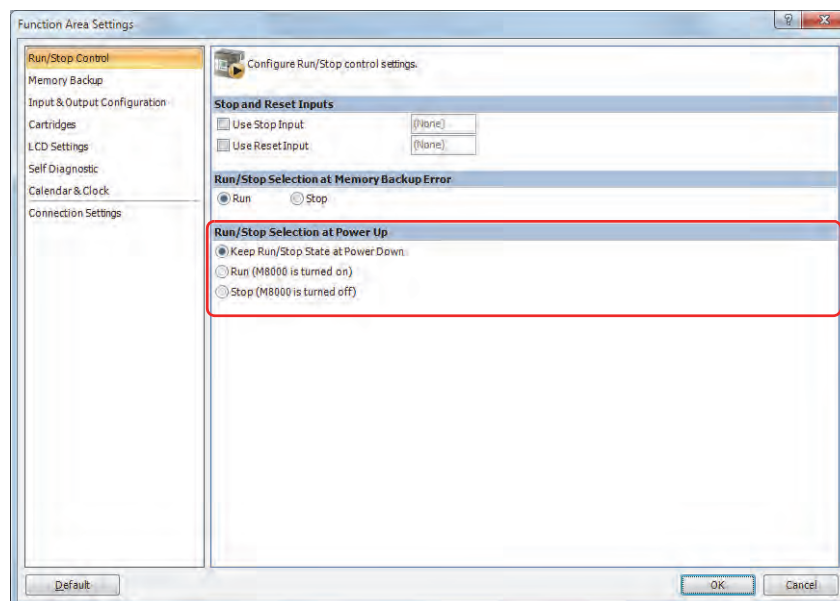

- 4 Click **OK**.

This concludes configuring the settings.

4.6 Keep and Clear Control Devices

This section describes the function for retaining or clearing the Touch Control devices.

● Feature Description

Devices that can issue instructions to retain or clear data are internal relays, shift registers, counter current values, and data registers. Relays and registers issued with clear instructions are cleared when operation starts. Values in the powered OFF state are retained until power is turned on and operation starts.

● Procedure

- 1 On the WindO/I-NV3 **View** tab, in the **Workspace** group, click  (Control Function) .
WindLDR starts.

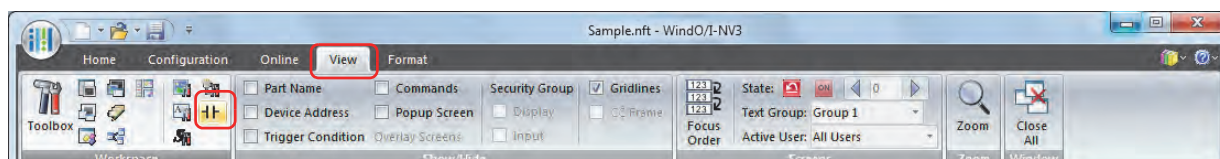

- 2 On the WindLDR **Configuration** tab, in the **Function Area Settings** group, click **Memory Backup**.
The Function Area Settings dialog box is displayed.
- 3 Click the buttons under Internal Relay, Shift Register, Counter, and Data Register to Clear all, Keep all, or Keep/Clear Specified Range as required.
To specify a clear/keep range, enter an upper limit and lower limit for the range.

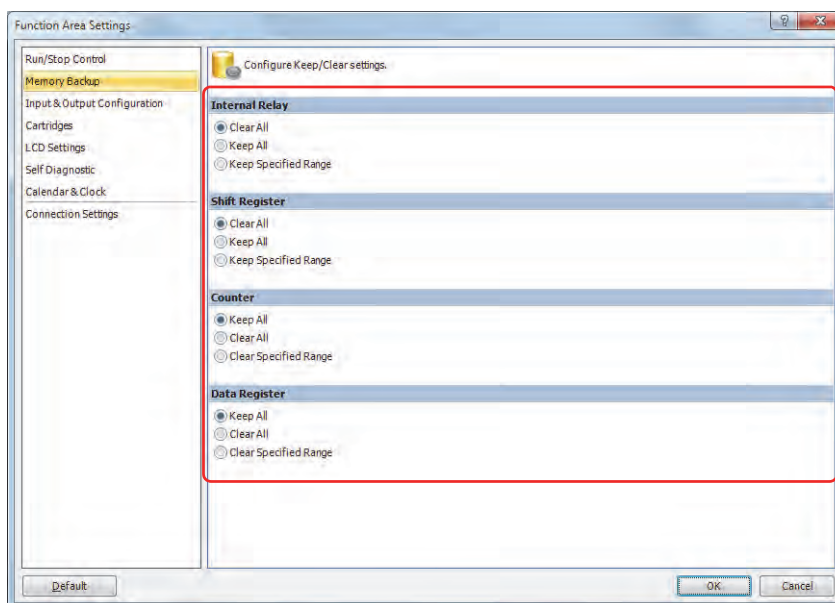

- 4 Click **OK**.
This concludes configuring the settings.

● Designation

The settings and actions for each control device are as follows.

■ Internal Relay (M)

Configuration	Operation
Clear All	All internal relays are cleared when the Touch starts operation.
Keep All	The states of all internal relays are retained while the Touch is powered OFF.
Keep Specified Range	The states of all internal relays are retained while the Touch is powered OFF. Internal relays outside the specified range are cleared when operation starts.

- The default setting is **Clear All**.

■ Shift Register (R)

Configuration	Operation
Clear All	All shift registers are cleared when the Touch starts operation.
Keep All	The states of all shift registers are retained while the Touch is powered OFF.
Keep Specified Range	The states of all shift registers are retained while the Touch is powered OFF. Shift registers outside the specified range are cleared when operation starts.

- The default setting is **Clear All**.

■ Counter (C)

Configuration	Operation
Keep All	Counter current values are retained when the Touch is powered OFF.
Clear All	All counter current values are cleared when the Touch starts operation.
Clear Specified Range	Only counter current values within the specified range are cleared when the Touch starts operation. Counter current values outside the specified range are retained.

- The default setting is **Keep All**.

■ Data Register (D)

Configuration	Operation
Keep All	Data register values are retained when the Touch is powered OFF.
Clear All	All data register values are cleared when the Touch starts operation.
Clear Specified Range	Only data register values within the specified range are cleared when the Touch starts operation. Data register values outside the specified range are retained.

- The default setting is **Keep All**.



- Relays and registers specified under **Clear All** or **Clear Specified Range** are cleared when the Touch starts operation. Values in the powered OFF state are retained until power is turned on and operation starts.
- It is not possible to configure keep/clear settings for special data registers. This action is equivalent to that of **Keep All**.
- It is not possible to configure keep/clear settings for special internal relays. For details about actions when power is cut or operation is stopped, refer to Chapter 27 "Special Internal Relay (M)" on page 27-5

4.7 High-Speed Counter

This section describes the high-speed counter for counting high-speed pulses from devices such as rotary encoders and proximity switches.

● Feature Description

The high-speed counter is a function that counts high-speed pulses which cannot be read in the execution of a normal ladder program or FBD program. The high-speed counter has a comparator function to compare the current value and a preset value (target value). When the current value and the preset value match, an external output is turned on or an interrupt program is executed. However, the interrupt program can only be used when ladder program is selected as the programming language.

The high-speed counter has a single-phase high-speed counter and a two-phase high-speed counter.

To use the high-speed counter, function area settings, data registers, special internal relays, and special data registers must be configured.

To use the high-speed counter, the following settings are required.

Ladder program: WindLDR function area settings and settings for data registers, special internal relays, and special data registers

FBD program: WindLDR function area settings and high-speed counter function block (HSC FB) settings
For details on the HSC FB, refer to Chapter 18 "The special FB" - "HSC (High-speed Counter)" in the "SmartAXIS FBD Programming Manual".

Application example

This application example punches holes into a roll of paper at a regular interval.

The two pulses (A-phase, B-phase) that carry the phase difference output from the rotary encoder are counted by the Touch two-phase high-speed counter.

When the current value reaches the preset value, the specified external output turns on and the perforator punches a hole in the roll of paper.

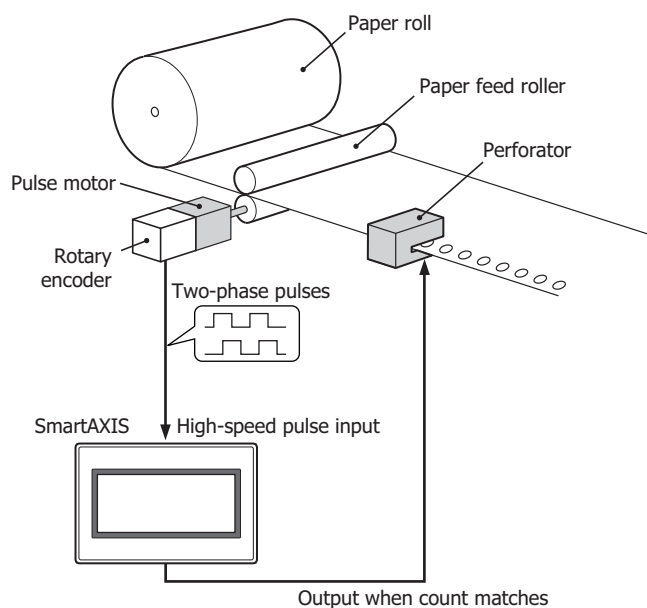

High-speed counter operation modes

The high-speed counter has the following two operation modes.

- Single-phase high-speed counter
- Two-phase high-speed counter

High-speed counting modes

The high-speed counter has the following three counting modes.

- Adding counter (single-phase high-speed counter)
- 2-edge count (two-phase high-speed counter)
- 4-edge count (two-phase high-speed counter)

Example: The input allocation when external input group 1 is specified as a two-phase high-speed counter

External input	I0	I1	I2
	↓	↓	↓
High-speed counter	A-phase	B-phase	External clear input (Z-phase)

- High-speed Counter External Inputs

The 12-I/O type can only use a maximum of four single-phase high-speed counters and a maximum of one dual-phase high-speed counter.

- **Single-phase high-speed counter**

The 12-I/O type cannot use external inputs I0 and I1 as single-phase high-speed counters.

Group	1		2	3	4	5
External input	I0	I1	I2	I3	I4	I5
Single-phase high-speed counter	–	–	Pulse input	Pulse input	Pulse input	Pulse input

- **Two-phase high-speed counter**

External inputs I0/I1 (group 1) can be used as two-phase high-speed counters. External inputs I2 can be used as external clear inputs for group 1. In this situation, external inputs I2 cannot be used as single-phase high-speed counters.

Group	1		2	3	4	5
External input	I0	I1	I2	I3	I4	I5
Two-phase high-speed counter	Pulse input (A-phase)	Pulse input (B-phase)	External clear input ^{*1} (Z-phase)	–	–	–

*1 If not used as the external clear input (Z-phase), group 2 can be used as single-phase high-speed counters.

● High-Speed Counter Operation

The high-speed counter turns on an external output or executes an interrupt program when the current value matches the preset value (target value).

The high-speed counter has two operation modes, single-phase high-speed counter and two-phase high-speed counter.

For how to configure the function to turn on an external output, refer to “Comparison Actions” on page 3-59.

■ Single-phase high-speed counter

Group 2, group 3, group 4, group 5 single-phase high-speed counter

- These groups only support adding counter.
- These groups support 10 kHz maximum pulse input and are capable of counting from 0 to 4,294,967,295 (32 bits).
- When the current value and the preset value match or an overflow occurs, an external output turns on or an interrupt program is executed.
- These groups only support the reset input via a special internal relay. When the reset is executed, the current value returns to the reset value specified by the special data registers.

Counting mode	Frequency
Adding counter	Group 2, 3, 4, 5: 10 kHz

■ Two-phase high-speed counter

Group 1 two-phase high-speed counter

- The two-phase high-speed counter counts by the phase difference between the A-phase and B-phase pulse input.
- These groups support 5 kHz maximum pulse input and are capable of counting from 0 to 4,294,967,295 (32 bits).
- Even higher speed counting is possible by specifying 2-edge count or 4-edge count.
- When the current value and the preset value match or an overflow or underflow occurs, an external output turns on or an interrupt program is executed.
- These groups support resetting the current value by the reset special internal relay or external clear input (Z-phase). When the reset is executed, the current value returns to the reset value specified by the special data registers.

Group	Frequency
Group 1	2-edge count: 5kHz
	4-edge count: 2.5kHz

● Counting mode

The high-speed counter has the following three counting modes.

■ Adding counter (single-phase high-speed counter)

The adding counter counts up with the rise in pulse input.

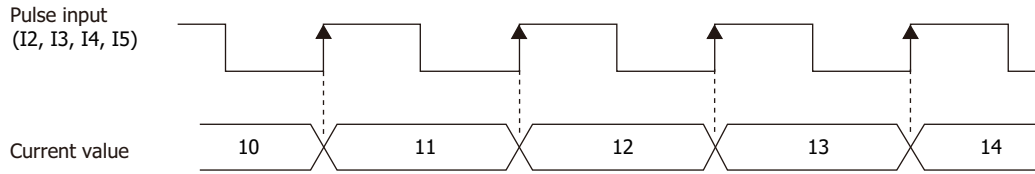

■ 2-edge count (two-phase high-speed counter)

This counter counts by the phase difference between A-phase and B-phase pulse input. When A-phase precedes B-phase, the counter counts up with the rise and fall of B-phase. When B-phase precedes A-phase, the counter counts down with the rise and fall of B-phase.

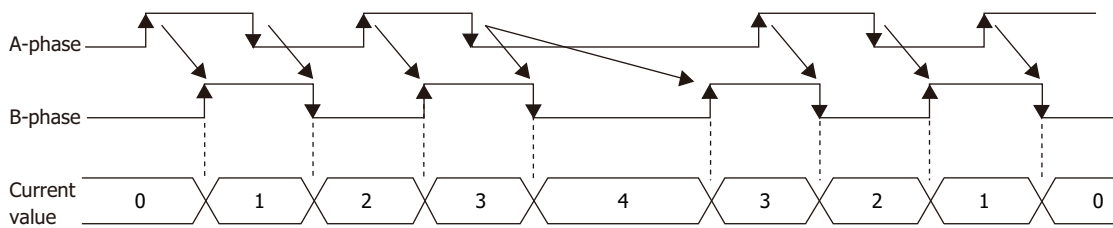

■ 4-edge count (two-phase high-speed counter)

This counter counts by the phase difference between A-phase and B-phase pulse input. When A-phase precedes B-phase, the counter counts up with the rise and fall of A-phase and B-phase. When B-phase precedes A-phase, the counter counts down with the rise and fall of A-phase and B-phase.

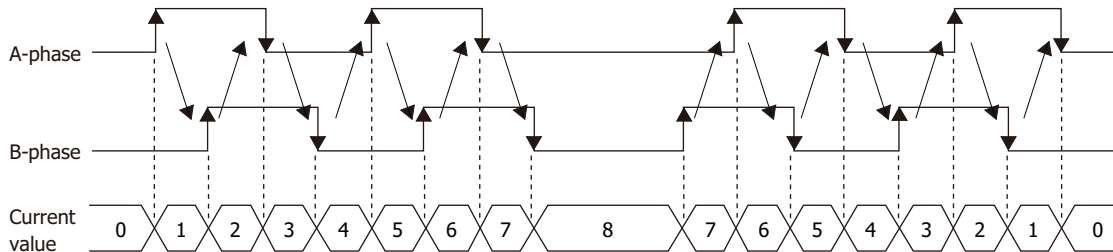

● Comparison Actions

The operating condition when comparing values is configured in the WindLDR **High-speed Counter Settings**, under **Comparison Action**.

The action when comparing values is **Comparison Output** or **Interrupt Program**, so specify an external output number or label number when comparing. However, the interrupt program can only be used when ladder program is selected as the programming language.

Operation

When the preset value and the current value are compared and the values match, the specified output is turned on or the interrupt program is executed.

A maximum of six high-speed counter preset values can be configured. For one preset value, the current value is compared with the same preset value each time.

When multiple preset values are configured, the preset value is changed each time the current value and preset value match.

For example, if four preset values are configured, when preset value 1 matches the current value, the comparison subject changes to preset value 2 → 3 → 4 in order.

When the final preset value 4 matches the current value, the preset value returns to preset value 1 and the values are compared.

■ Preset value storage locations

The preset values during high-speed counter operation are stored as 2 words in special data registers.

Group	1 (I0 to I1)	2 (I2)	3 (I3)	4 (I4)	5 (I5)	Read/Write
Preset Value (Upper word)	D8052	D8058	D8070	D8136	D8142	R/W
Preset Value (Lower word)	D8053	D8059	D8071	D8137	D8143	

Specify the data registers to store the preset values in WindLDR and store those preset values in the ladder program or FBD program. Specify the starting address of the data registers to allocate the data registers to the individual settings in the comparison settings. When the high-speed counter is executed, the preset value with the number stored in **Current Preset Value Number** is active. The active preset value number for each comparison is stored in **Current Preset Value Number** and the next active preset value number is automatically stored in **Next Preset Value Number**. By changing the value of **Next Preset Value Number** in the ladder program or FBD program, the next active preset value number can be changed. The active preset value is stored for each group in the special data registers shown in the table above.

Example: Group 1, number of preset values is 3, set to device address D0000

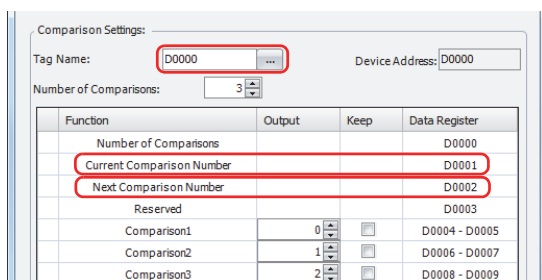

When the current value matches preset value 1, **Current Preset Value Number** becomes 2 and 3 is stored in **Next Preset Value Number**.

When the device address is configured as D0000, **Current Preset Value Number** is stored in D0001 and **Next Preset Value Number** is stored in D0002.

For the group 1 preset value, the value of the data registers (D0004, D0005) allocated to preset value number 1 is stored in D8052 and D8053 as shown in the table above and it is compared to the current value.

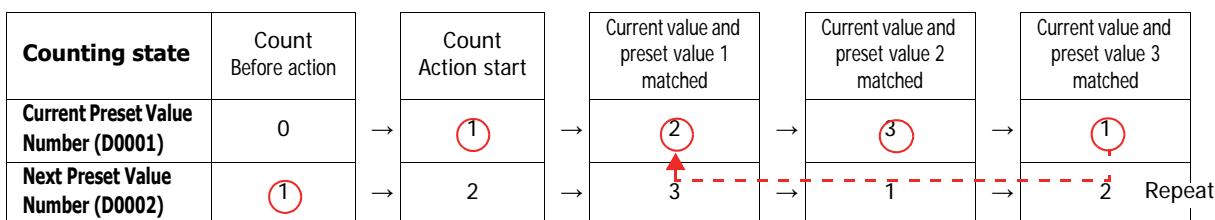

Before the count action, set the Next Preset Value Number and preset value 1 to 3 to the count values with the initialize pulse in ladder program or FBD program.

Preset value 1 is set to **Current Preset Value Number**

Preset value 2 is set.

Preset value 3 is set.

Once again, preset value 1 is set.



When the **Next Preset Value Number** preset value becomes active, the high-speed counter preset value during execution does not change, even when the preset value for that preset value number is changed. When the current value and the current preset value match, the preset value with the number stored in **Next Preset Value Number** becomes active. Changes to the **Next Preset Value Number** data register must be performed before the preset value becomes active.

Comparison operation flow

The comparison operation flow is as follows.

1 Start (Run) the Touch.

For the first scan, **Next Preset Value Number** is set to the number for preset value 1 with the initialize pulse.

For the second scan, an I/O refresh is performed in END processing and the value of **Next Preset Value Number** is transferred to **Current Preset Value Number**.

The content of **Next Preset Value Number** becomes the preset value n + 1 ("2" in this example).

When the number of preset values is 1, **Next Preset Value Number** is always "1".

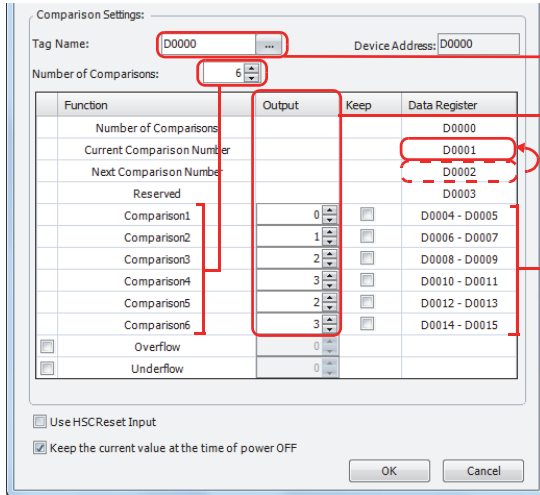

The data register that stores the preset value (target value). Specify the starting address.

The outputs (external outputs) when the values match.

Transfer

The preset value with the number that became active is the comparison subject with the current value and is stored in the special data registers.

Example: For group 1

Storage destination for the preset value that became active. Stored by group.

Group	Group 1 (I0 to I1)	Read/Write
Preset Value (Upper word)	D8052	R/W
Preset Value (Lower word)	D8053	

2 Start the high-speed counter count operation.

Turn on the gate input to start the count operation.

3 Compare the **Current Preset Value Number** preset value and the current value. When the current value and the preset value match, the next number for the preset value becomes active and the high-speed counter continues counting.

Execute **Comparison Output** or **Interrupt Program**. (**Comparison Output** in this example)

- Turn on the comparison (special internal relay) for only one scan.
- Overwrite **Current Preset Value Number** with **Next Preset Value Number** and start the count with the preset value for **Current Preset Value Number**.
- Add 1 to **Next Preset Value Number**.

4 When the procedure is executed up to preset value 6, repeat again from the beginning with preset value 1.



The **Current Preset Value Number** data register cannot be written to. It is read-only. **Next Preset Value Number** and **Preset Value 1** to **Preset Value 6** can be read and written to.

● Procedure

To use the high-speed counter, a normal input must be specified as **Two-phase High-speed Counter** or **Single-phase High-speed Counter** in the **Function Area Settings** tab. Inputs I0 to I7 on the Touch can be selected as normal input, high-speed counter, catch input, interrupt input, and frequency measurement.

When using normal input, catch input, interrupt input, or frequency measurement, high-speed counter cannot be used. The interrupt input can only be used when ladder program is selected as the programming language.

- 1 On the WindO/I-NV3 **View** tab, in the **Workspace** group, click  (Control Function). WindLDR starts.

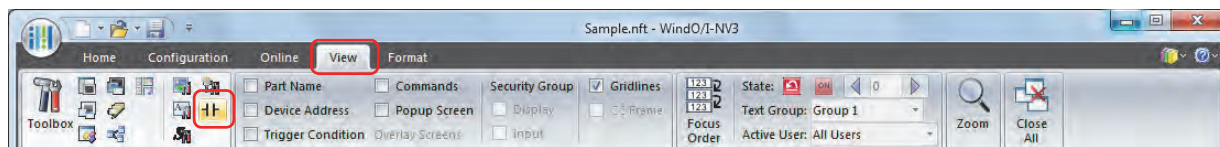

- 2 On the WindLDR **Configuration** tab, in the **Function Area Settings** group, click **Input & Output Configuration**. The Function Area Settings dialog box is displayed.
- 3 Select **Two-phase High-speed Counter** or **Single-phase High-speed Counter** for the group to use the high-speed counter. The High-speed Counter Settings dialog box is displayed.

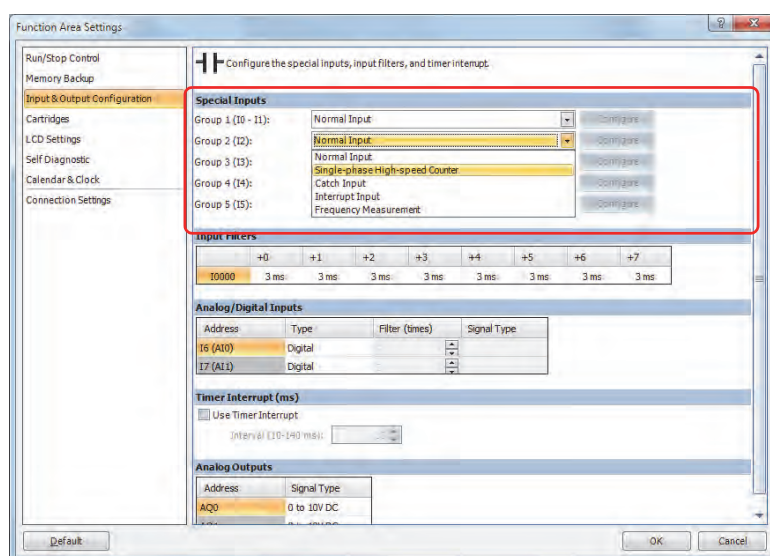

- 4 Configure the operation mode and the counting mode, and then click **OK**. To use comparison actions, configure the comparison settings.

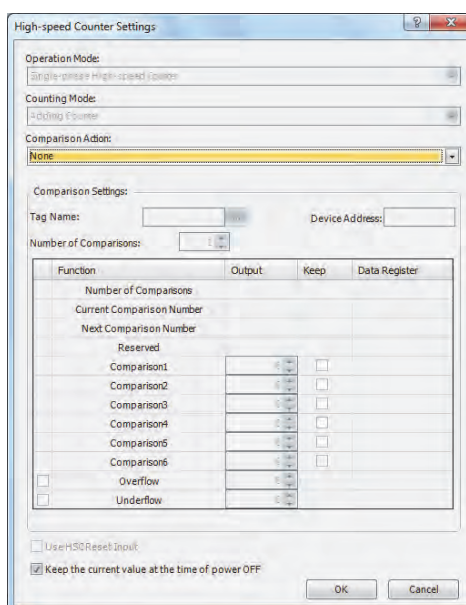

- 5 Click **OK**. This concludes configuring the settings.

● Settings

■ Operation Mode

Inputs for group 2, group 3, group 4 and group 5 can only be used as single-phase high-speed counters. When group 1 is selected as the high-speed counter, group 2 (I2) can be used as clear input.

■ Counting Mode (single-phase high-speed counter)

The adding counter can only be used for group 2, group 3, group 4 and group 5 high-speed counters.

Adding Counter

The adding counter counts up with the rise in pulse input.

■ Counting Mode (two-phase high-speed counter)

When the two-phase high-speed counter is specified for **Operation Mode** for group 1, the counting mode can be selected as **2-edge count** or **4-edge count**. The two-phase counter cannot be used for the group 2, group 3, group 4 and group 5 high-speed counters.

2-edge count

This counter counts at double the frequency of the input pulse.

This counter counts by the phase difference between the A-phase and B-phase pulse input. When A-phase precedes B-phase, the counter counts up with the rise and fall of B-phase. When B-phase precedes A-phase, the counter counts down with the rise and fall of B-phase.

4-edge count

This counter counts at quadruple the frequency of the input pulse.

This counter counts by the phase difference between A-phase and B-phase pulse input. When A-phase precedes B-phase, the counter counts up with the rise and fall of A-phase and B-phase. When B-phase precedes A-phase, the counter counts down with the rise and fall of A-phase and B-phase.

■ Comparison Action

The comparison action is a function that compares the high-speed counter's current value with a preset value (target value).

It can use either the comparison output or an interrupt program. However, the interrupt program can only be used when ladder program is selected as the programming language.

- When **Comparison Output** is selected, the specified external output is turned on when the current value and the preset value match.
- When **Interrupt Program** is selected, the subroutine program with the specified label number is executed as the interrupt program when the current value and the preset value match.

Overflow and underflow can also be used for the comparison conditions.

For details on the comparison actions, refer to "Comparison Actions" on page 3-59.

■ Comparison Settings

When using the comparison output or the interrupt program as the comparison action for the high-speed counter, configure the external output number or the label number when there is a match. A maximum of six preset values can be specified for **Number of Comparisons** (preset value number 1 to 6).

Tag Name

Specify the Tag name which is allocated to the starting address of the data register region to store the preset values.

Device Address

Shows the address of the data register specified by the tag name.

Number of Comparisons

You can configure a maximum of six preset values (target values) for the comparison action.



- The preset value becomes active by the END processing in the second scan after the Touch starts operation. Store **Preset Value** in the data registers with initialize pulse M8120 input.
- When the preset value (special data register) is changed before the comparison, the preset value currently being used for the comparison is discarded in the program's END processing, and the comparison is performed with the newly configured preset value.

Output

When a comparison action is selected, these are the external outputs specified for preset value 1 to 6.

The external outputs that can be used as comparison outputs are Q0 to Q3.

Overflow

Select this check box to use overflow in the comparison action conditions (when the current value exceeds 4,294,967,295).

Underflow

Select this check box to use underflow in the comparison action conditions (when the current value falls below 0).



When the comparison action is **Comparison Output** and either a preset value, overflow, or underflow has been enabled as a comparison condition, the text box to enter the comparison output is enabled. The comparison output can be specified for each of these match conditions.

■ **Keep**

After the current value matches the preset value, select to reset the current value to a reset value or to keep the value. Select this check box to keep the current value.

■ **Use HSC Reset Input**

Select this check box to reset the current value to a reset value with external input (high-speed counter reset input). High-speed counter reset input can only be specified for group 1.

Group	External input
Group 1	I2

When high-speed counter reset input is turned on, the current value is reset to a reset value.

If high-speed counter reset input is not used, I2 is normal input.

■ **Keep the current value at the time of power OFF**

Select this check box to maintain the current values that have been kept with the backup battery when the Touch is turned on. This setting can be set for each group of Special Inputs. If this check box is cleared, the current values change to 0.

High-speed counter devices

The high-speed counter operates according to special internal relay and special data register settings. While the high-speed counter is operating, the current value, control output, and operating status value are reflected in the special internal relays and special data registers with each scan.

The high-speed counter start and stop control signals and the current value, preset values, and reset values are allocated to the special internal relays and special data registers.

Device allocation table

The devices used by the high-speed counter are as follows.

Special internal relay list

Group	1 (I0 to I1)	2 (I2)	3 (I3)	4 (I4)	5 (I5)	Read/Write
Comparison Output Reset	M8030	M8040	M8055	M8166	M8173	R/W
Gate Input	M8031	M8041	M8056	M8167	M8174	
Reset Input	M8032	M8042	M8057	M8170	M8175	
Reset Status	M8033	–	–	–	–	R
Comparison ON Status	M8034	M8043	M8060	M8171	M8176	
Overflow	M8035	M8044	M8061	M8172	M8177	
Underflow	M8036	–	–	–	–	
Count Direction Flag	M8037	–	–	–	–	

Special data register list

Group	1 (10 to I1)	2 (12)	3 (13)	4 (14)	5 (15)	Read/Write
Current Value (Upper word)	D8050	D8056	D8068	D8134	D8140	R
Current Value (Lower word)	D8051	D8057	D8069	D8135	D8141	
Preset Value (Upper word)	D8052	D8058	D8070	D8136	D8142	R/W
Preset Value (Lower word)	D8053	D8059	D8071	D8137	D8143	
Reset Value (Upper word)	D8054	D8060	D8072	D8138	D8144	
Reset Value (Lower word)	D8055	D8061	D8073	D8139	D8145	

When using the devices above with instructions or FB where the data type unit can be specified, specify the data type as double word (D). When the 32-bit data storage setting in the function area settings is set to **from Lower Word**, the lower word is stored in the first device.

- Start/stop high-speed counter

The high-speed counter can be started and stopped per group by turning the gate input on or off.

Group	1 (10 to I1)	2 (12)	3 (13)	4 (14)	5 (15)	Read/Write
Gate Input	M8031	M8041	M8056	M8167	M8174	R/W

- Current value storage locations

The current value for the single-phase high-speed counter is stored in special data registers as 2 words per group.

Group	1 (10 to I1)	2 (12)	3 (13)	4 (14)	5 (15)	Read/Write
Current Value (Upper word)	D8050	D8056	D8068	D8134	D8140	R
Current Value (Lower word)	D8051	D8057	D8069	D8135	D8141	

When the 32-bit data storage setting in the function area settings is set to **from Lower Word**, the lower word is stored in the first device.

- Comparison ON status

When the current value and the preset value match, the special internal relay turns on for only one scan.

Group	1 (10 to I1)	2 (12)	3 (13)	4 (14)	5 (15)	Read/Write
Comparison ON Status	M8034	M8043	M8060	M8171	M8176	R

- Overflow

When the current value exceeds 4,294,967,295, the special internal relay turns on for only one scan. When the current value overflows, it becomes 0.

Group	1 (10 to I1)	2 (12)	3 (13)	4 (14)	5 (15)	Read/Write
Overflow	M8035	M8044	M8061	M8172	M8177	R

- Underflow

When the current value falls below 0, the special internal relay turns on for only one scan. When the current value underflows, it becomes 4,294,967,295.

Group	1 (10 to I1)	2 (12)	3 (13)	4 (14)	5 (15)	Read/Write
Underflow	M8036	–	–	–	–	R

■ Comparison output reset

When the special internal relay turns on, the comparison output selected on **High-speed Counter Settings** turns off.

Group	1 (I0 to I1)	2 (I2)	3 (I3)	4 (I4)	5 (I5)	Read/Write
Comparison Output Reset	M8030	M8040	M8055	M8166	M8173	R/W

■ Reset input

When reset input is turned on, the current value returns to the reset value.

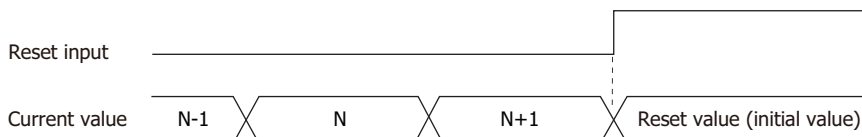

Group	1 (I0 to I1)	2 (I2)	3 (I3)	4 (I4)	5 (I5)	Read/Write
Reset Input	M8032	M8042	M8057	M8170	M8175	R/W

■ Preset value, reset value storage locations

The preset value and the reset value for the high-speed counter are stored in special data registers as 2 words.

Group	1 (I0 to I1)	2 (I2)	3 (I3)	4 (I4)	5 (I5)	Read/Write
Preset Value (Upper word)	D8052	D8058	D8070	D8136	D8142	R/W
Preset Value (Lower word)	D8053	D8059	D8071	D8137	D8143	
Reset Value (Upper word)	D8054	D8060	D8072	D8138	D8144	
Reset Value (Lower word)	D8055	D8061	D8073	D8139	D8145	

When the 32-bit data storage setting in the function area settings is set to **from Lower Word**, the lower word is stored in the first device.

■ HSC reset input and reset status

When the HSC reset input is enabled in group 1, turn on HSC reset input I2 to return the current value to the reset value.

In this situation, reset status turns on for only one scan.

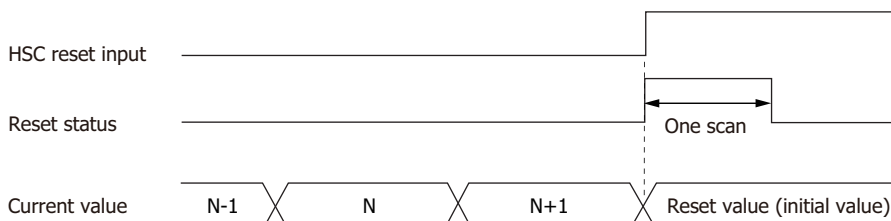

Group	1 (I0 to I1)	2 (I2)	3 (I3)	4 (I4)	5 (I5)	Read/Write
HSC Reset Input	I2	–	–	–	–	–
Reset Status	M8033	–	–	–	–	R

To use the reset input with group 1 single-phase high-speed counter, use I2 (group 2). When not using I2 as a reset input, it can be used as normal input, high-speed counters, catch input, interrupt input, or frequency measurements.

■ Count direction flag

These special internal relays maintain whether group 1 current value count is being added or subtracted.

When these special internal relays are on, they indicate addition. When they are off, they indicate subtraction.

Group	1 (I0 to I1)	2 (I2)	3 (I3)	4 (I4)	5 (I5)	Read/Write
Count Direction Flag	M8037	–	–	–	–	R

● Timing chart 1

Single-phase high-speed counter (group 5) timing chart

Operating conditions

One preset value is used, and when the values match, output Q1 turns on and the current value is kept.
Overflow and underflow are not used.

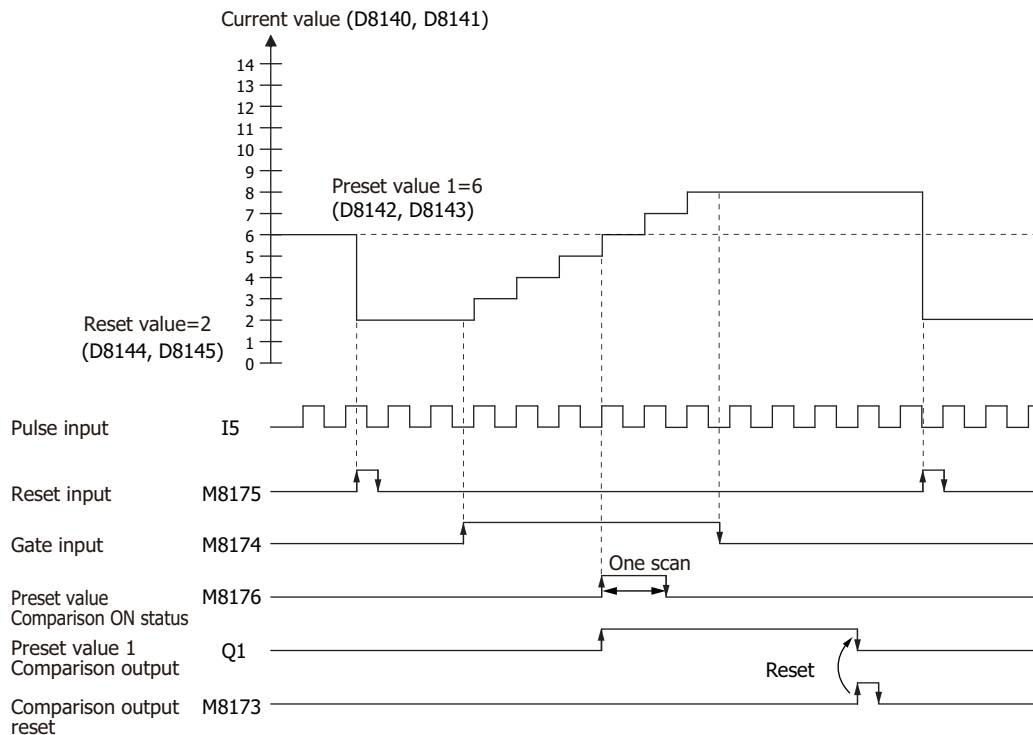

- 1 When reset input (M8175) turns on, the reset value (D8144, D8155) is stored in the current value (D8140, D8141).
- 2 When gate input (M8174) turns on, the counting begins.
- 3 When the current value (D8140, D8141) and preset value 1 (D8142, D8143) match, the preset value 1 comparison output (Q1) and Comparison ON status (M8176) turn on. When the **Keep** check box is selected in the settings in the WindLDR **High-speed Counter Settings**, the current value is kept.
- 4 Q1 maintains the on state until comparison output reset (M8173) turns on. Preset value Comparison ON status (M8176) turns on for only one scan.
- 5 When the gate output turns off, counting stops.



High-speed counter usage precautions

The high-speed counter starts the count operation with the following two conditions.

- The Touch starts operation.
- The gate input is turned on.

To start the count operation, turn the gate input on from off when the Touch is running. When the gate input is already on when the Touch is stopped, the count operation starts when the Touch is switched from stop to run.

When a ladder program or FBD program is downloaded during the count operation, the count operation stops. The count operation will restart by setting the Touch to run.

● Timing chart 2

Two-phase high-speed counter (group 1) timing chart

Operating conditions

The counting mode is set to **2-edge count** and reset input (I2) is used.

Two preset values are used, and when preset value 1 matches, output Q1 turns on and the current value is kept.

When preset value 2 matches, output Q2 turns on and the current value is cleared.

Overflow and underflow are not used.

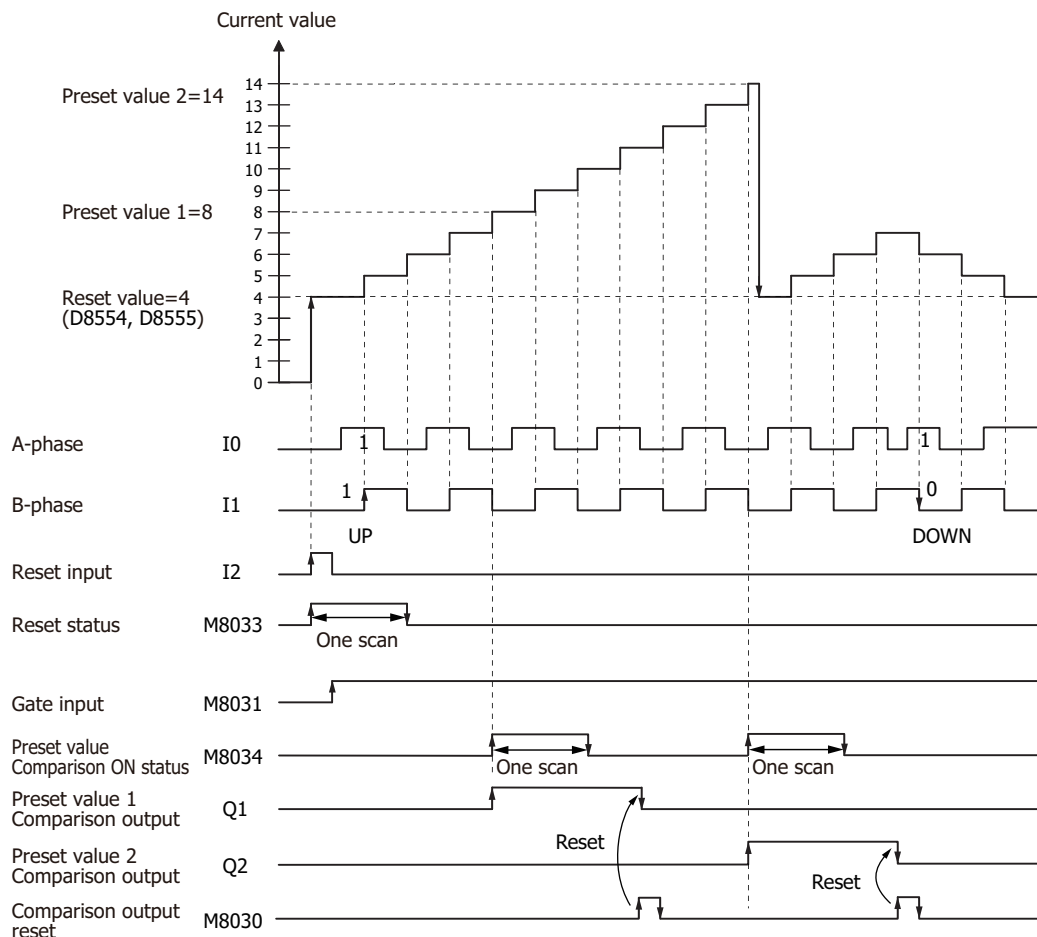

- 1 When reset input (I2) turns on, the reset value (D8054, D8055) is stored in the current value (D8050, D8051). In this situation, reset status (M8033) turns on for only one scan.
- 2 When gate input (M8031) turns on, counting begins.
- 3 When A-phase pulse (I0) precedes B-phase pulse (I1), the count goes up. When B-phase pulse (I1) precedes A-phase pulse (I0), the count goes down.
- 4 When the current value and preset value 1 (D8052, D8053) match, the preset value 1 comparison output (Q1) and setting value match (M8034) turn on. When preset value 1 matches, preset value 2 is stored in the preset value (D8052, D8053) as the new preset value and counting continues.
- 5 The preset value 1 comparison output (Q1) maintains the on state until comparison output reset (M8030) turns on. M8034 turns on for only one scan.

● Example 1

Using the single-phase high-speed counter in the ladder program, this example program turns on external output Q2 when 1,000 pulses are input.

Application description

When pulses are input to input I0 and the count reaches 1,000, output Q2 is turned on.

- 1 In the WindLDR, on the **Configuration** tab, in the **Function Area Settings** group, click the **Input Configuration**. The Function Area Settings dialog box is displayed.
- 2 Select the **Single-phase High-speed Counter** for **Group 2**. The High-speed Counter Settings dialog box is displayed.

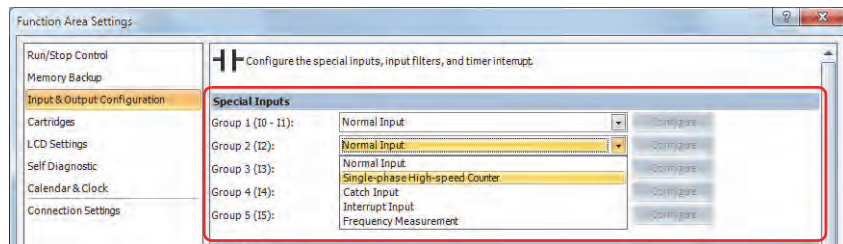

- 3 Configure the settings as follows, and then click **OK**.

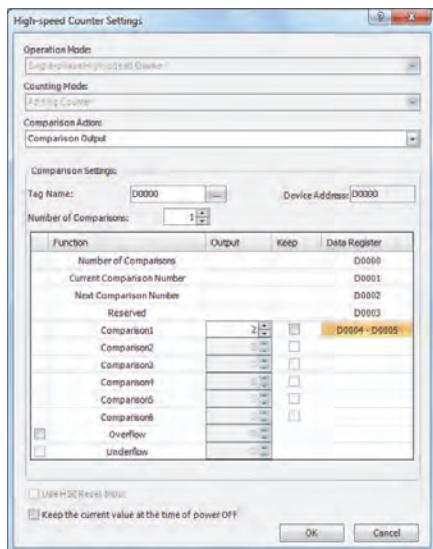

- External input : Group 2 (I2)
- Operation Mode : Single-phase High-speed Counter
- Counting Mode : Adding Counter
- Comparison Action : Comparison Output

Comparison Settings

- Tag Name/Device Address : D0000 (data register)
- Number of Comparisons : 1
- Comparison output : Q2 (external output when matched)
- Comparison1 (D4) : 0 (upper word)
- Comparison1 (D5) : 1,000 (lower word)
- Keep : Cleared
- Reset value (D8054) : 0 (upper word)
- Reset value (D8055) : 0 (lower word)
- Overflow : Cleared
- Underflow : Cleared
- Use HSC Reset Input : Cleared
- Keep the current value at the time of power OFF : OFF

Ladder program

M8120 (initialize pulse) is a special internal relay that turns on for one scan when the Touch runs.

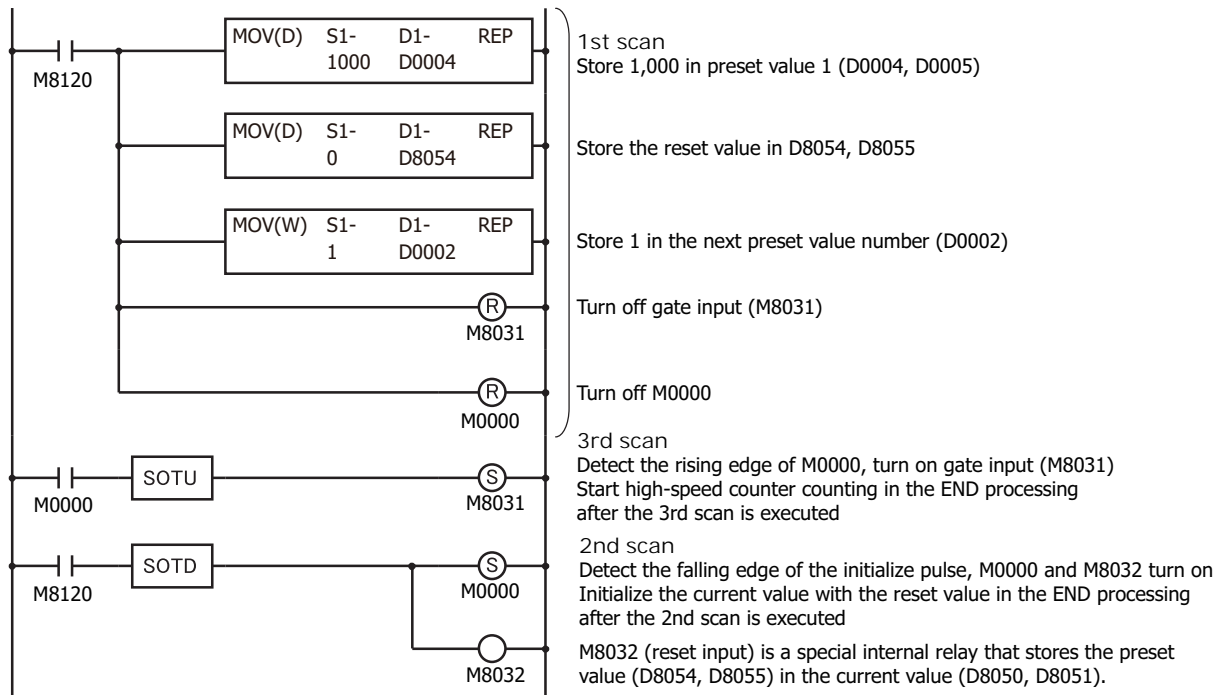

● Example 2

Using the two-phase high-speed counter, the pulses from a rotary encoder are input to the Touch and a continuous workpiece is marked at a regular interval.

Application description

- The rotary encoder pulses are input to input I0. A continuous sheet of paper is marked (holes are punched) at a regular interval (every 2,700 pulses).
- The rotary encoder is directly connected to the paper feed roller, and output pulses are counted by the high-speed counter and controlled.
- The cycle time is the time to count 2,700 pulses. When the hole punch time is 0.5 seconds, the operation condition is 2,700 pulse count time > 0.5 seconds.

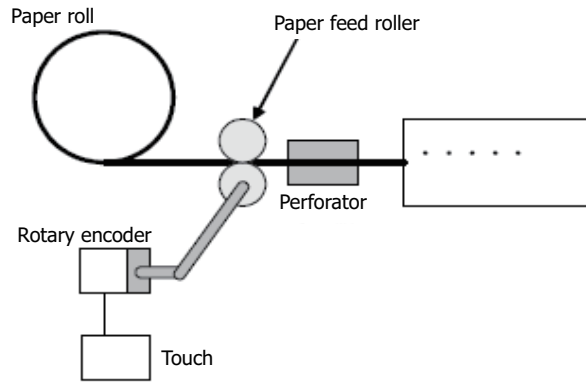

- 1 In the WindLDR, on the **Configuration** tab, in the **Function Area Settings** group, click the **Input Configuration**. The Function Area Settings dialog box is displayed.
- 2 Select the **Two-phase High-speed Counter** for **Group 1**. The High-speed Counter Settings dialog box is displayed.

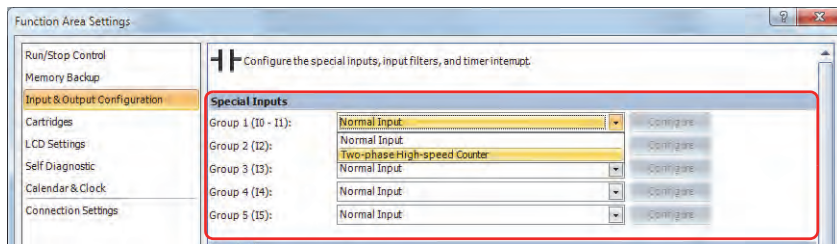

- 3 Configure the settings as follows, and then click **OK**.

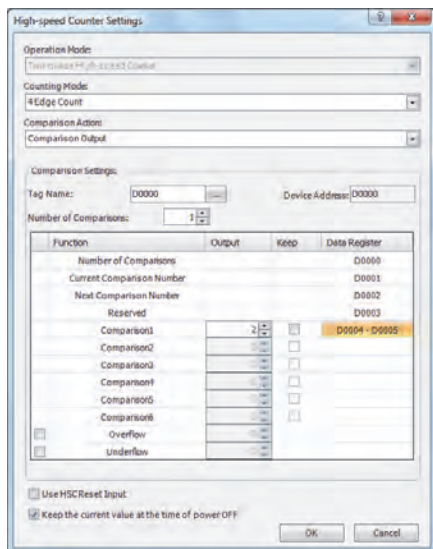

- External input : Group 1 (I0 to I1)
 - Operation Mode : Two-phase High-speed Counter
 - Counting Mode : 4 Edge Count
 - Comparison Action : Comparison Output
- Comparison Settings**
- Tag Name/Device Address : D0000 (data register)
 - Number of Comparisons : 1
 - Comparison output : Q2 (external output when matched)
 - Comparison1 (D0004) : 0 (upper word)
 - Comparison1 (D0005) : 2,700 (lower word)
 - Keep : Cleared
 - Reset value (D8054) : 0 (upper word)
 - Reset value (D8055) : 0 (lower word)
 - Overflow : Cleared
 - Underflow : Cleared
 - Use HSC Reset Input : Cleared
 - Keep the current value at the time of power OFF : ON

Program

M8120 (initialize pulse) is a special internal relay that turns on for one scan when the Touch runs.

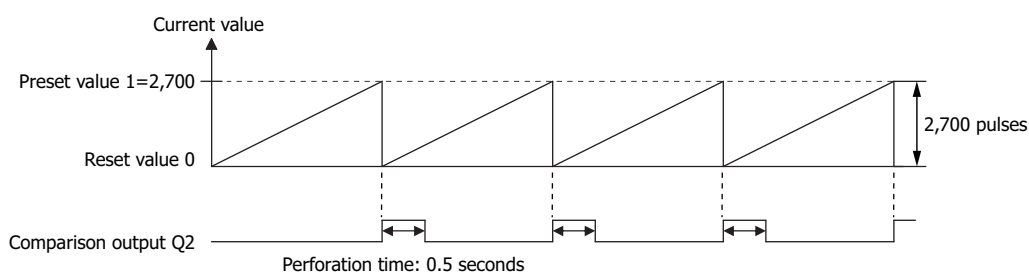
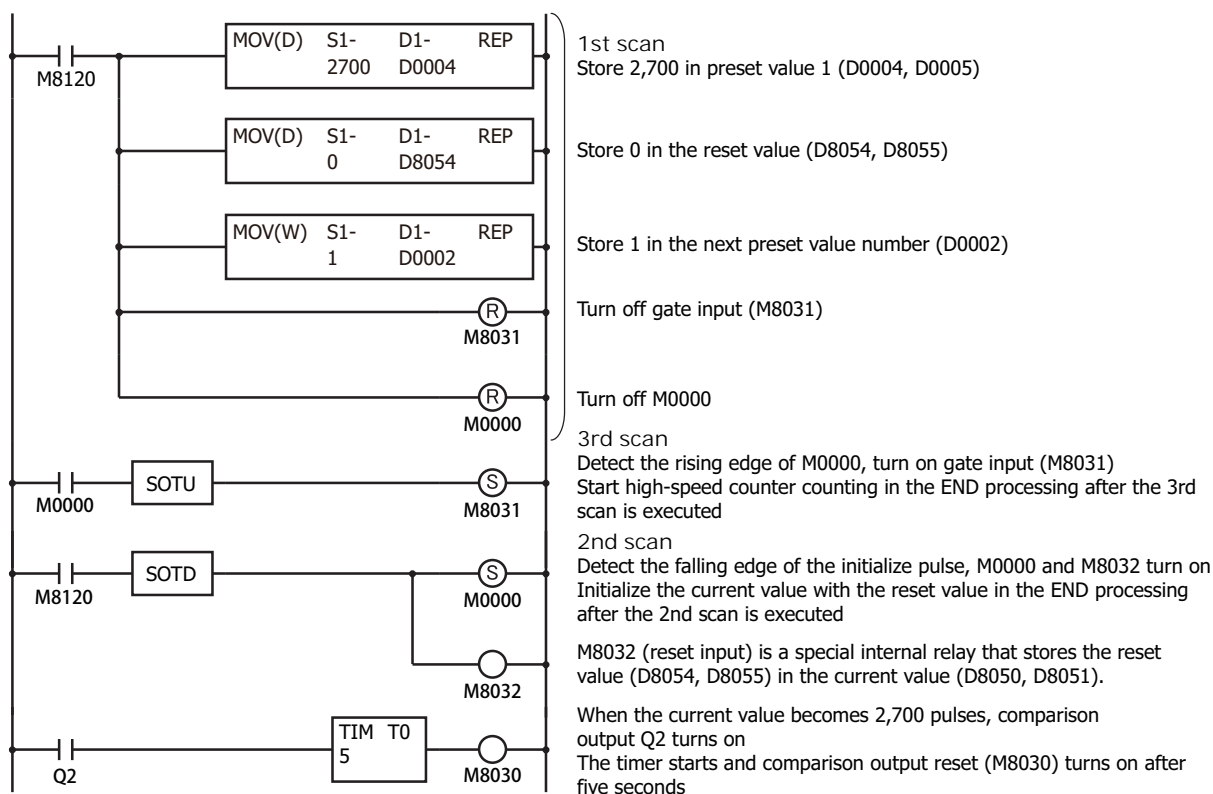

In this example, Z-phase reset input is not used.

4.8 Catch Input

This section explains catch inputs, which reliably capture short pulses such as sensor signals.

● Feature Description

Catch inputs are used to capture short pulses that change within the timeframe of a single scan. If catch inputs are used, ON/OFF states are stored in special internal relays (M8091 to M8094) corresponding to each group of external inputs, in accordance with the state of the external inputs during the time of one scan, and these signals can be used as input conditions. When a pulse is captured, the special internal relays turns ON or OFF during a single scan. If the pulse is captured again during the next scan, the special internal relays will again turn ON/OFF during the scan.

To use catch inputs, specify **Catch Input** for the external input group that uses catch inputs under **Function Area Settings** in WindLDR.

Catching Rising Edge of Input Pulse

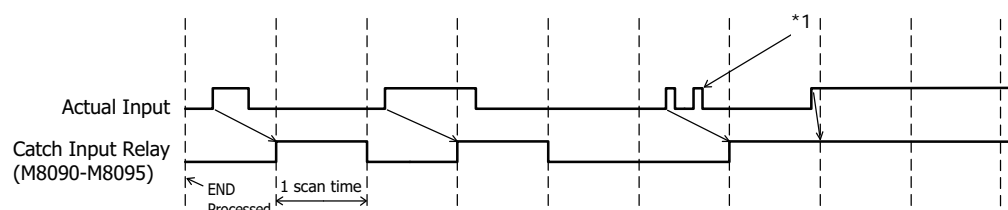

Catching Falling Edge of Input Pulse

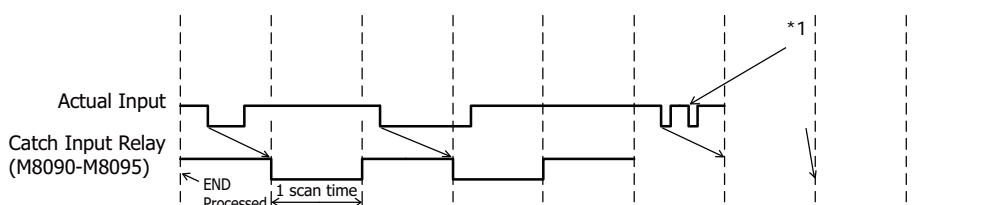

Catch Input Specifications

Minimum Turn ON Pulse Width: 50 μsec/Minimum Turn OFF Pulse Width: 50 μsec

● Input

The Touch inputs can be configured as normal inputs, high-speed counters, catch inputs, interrupt inputs, or frequency measurement. To use catch inputs, specify **Catch Input** for the applicable group under **Function Area Settings**.

Group	1	2	3	4	5
External Input	I0	I1	I2	I3	I4
Catch Input	-	-	Catch Input	Catch Input	Catch Input

The states of external inputs assigned to catch inputs are stored in the following special internal relays for each group. (Read Only)

Group	Catch Input	Special Internal Relay for Catch Input
Group 2	I2	M8091
Group 3	I3	M8093
Group 4	I4	M8094
Group 5	I5	M8095

The 12-I/O type cannot use external inputs I6 and I7 as catch inputs on Touch.



Input filter settings have no effect on the catch inputs.

*1 When two or more pulses enter within one scan, subsequent pulses are ignored.

- Procedure

- 1 On the WindO/I-NV3 **View** tab, in the **Workspace** group, click  (Control Function).
WindLDR starts.

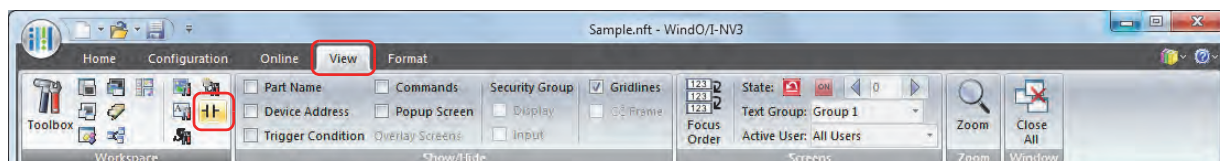

- 2 On the WindLDR **Configuration** tab, in the **Function Area Settings** group, click **Input & Output Configuration**.
The Function Area Settings dialog box is displayed.
- 3 Select **Catch Input** in the Groups 1 through 6 pull-down list boxes.
The Catch Input dialog box is displayed.

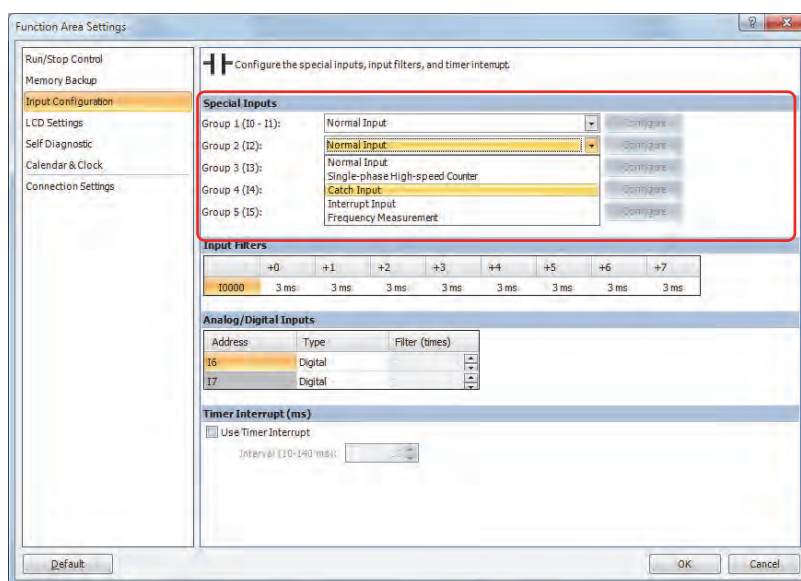

- 4 Select **Catch Input Rising Edge** or **Catch Input Falling Edge** in the pull-down list, and then click **OK**.

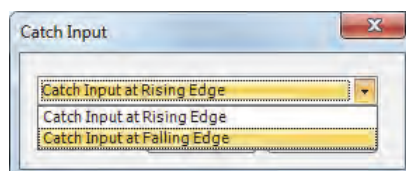

- 5 Click **OK**.
This concludes configuring the settings.

- Example: Maintaining Catch Input

When a catch input is received, the catch input relay assigned to a catch input is turned on for only one scan. This example demonstrates a program to maintain a catch input status for more than one scan.

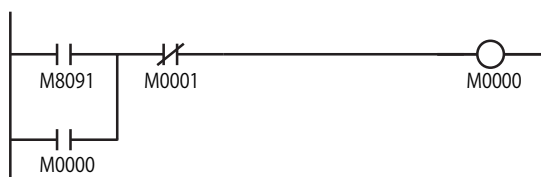

Input I2 is designated as a catch input using the Function Area Settings.

When input I2 is turned on, special internal relay M8091 is turned on, and M0000 is maintained in the self-holding circuit.

When NC input M1 is turned off, the self-holding circuit is unlatched, and M0 is turned off.

M0 is used as an input condition for the subsequent program instructions.

4.9 Interrupt Input

This section explains interrupt inputs, which can be used to interrupt execution of a ladder program by means of an external input to execute a subroutine.

The interrupt input can only be used when ladder program is selected as the programming language.

● Feature Description

In the processing of normal ladder programs, execution proceeds iteratively from beginning to end, but if an interrupt input is used, ladder program execution can be temporarily paused in order to execute a subroutine, irrespective of scans. With an interrupt input, a subroutine of predetermined label No. is run as an interrupt program when the external input is turned ON. When processing of the subroutine program is ended, execution of the interrupt program resumes. Up to 4 interrupt inputs can be set for external input groups 2 to 5.

● Function Specification

The Touch inputs can be configured as normal inputs, high-speed counters, catch inputs, interrupt inputs, or frequency measurement. To use catch inputs, specify Interrupt Input for the applicable group under **Function Area Settings**.

Jump destination label Nos. are stored in special data registers (D8033 to D8035, D8037, D8038).

Whether or not an interrupt input is allowed can be checked by the interrupt input state of the special internal relay (ON: Allowed, OFF: Prohibited).

Group	1		2	3	4	5
External Input	I0	I1	I2	I3	I4	I5
Interrupt input	–	–	Interrupt input	Interrupt input	Interrupt input	Interrupt input
Special Data Register (Jump Destination Label No.)	–	–	D8033	D8035	D8037	D8038
Special Internal Relay (Interrupt Input Status): Read only	–	–	M8071	M8073	M8074	M8075

The 12-I/O type cannot use external inputs I6 and I7 as interrupt inputs on Touch.

● Disable and Enable Interrupts

The interrupt inputs I2, I3, I4, and I5 and timer interrupt are normally enabled while the Touch is running, and can also be individually disabled using the DI instruction or enabled using the EI instruction. When interrupt inputs I2, I3, I4, and I5 are enabled, special internal relay are turned on, respectively. For details, refer to Chapter 16 "Interrupt Control Instructions" in "SmartAXIS Ladder Programming Manual".

When the Touch starts operation, interrupt inputs are set to the interrupt allowed state.

● Notes for Using Interrupt Inputs and Timer Interrupt:

- When using an interrupt input or timer interrupt, separate the interrupt program from the main program using the END instruction at the end of the main program.
- When an interrupt program calls another subroutine, a maximum of 3 subroutine calls can be nested. If more than 3 calls are nested, a ladder program execution error occurs.
- When using an interrupt input or timer interrupt, include the label number of the interrupt program to be executed when an interrupt occurs. The label numbers stored in data registers D8033 through D8035, D8037, and D8038 specify the interrupt programs for interrupt inputs I2, I3, I4, and I5 and timer interrupt, respectively.
- When more than one interrupt input is turned on at the same time, interrupt program execution is given priority to inputs I2, I3, I4 and I5, in that order. If an interrupt is initiated while another interrupt program is executed, the subsequent interrupt program is executed after the prior interrupt is completed. Multiple interrupt programs cannot be executed simultaneously.
- Make sure that the execution time of the interrupt program is shorter than interrupt intervals sufficiently.
- Interrupt programs cannot use some instructions. For details, refer to Chapter 12 "2.2 Instructions Reference" on page 12-14.

- Procedure

- 1 On the WindO/I-NV3 **View** tab, in the **Workspace** group, click  (Control Function).
WindLDR starts.

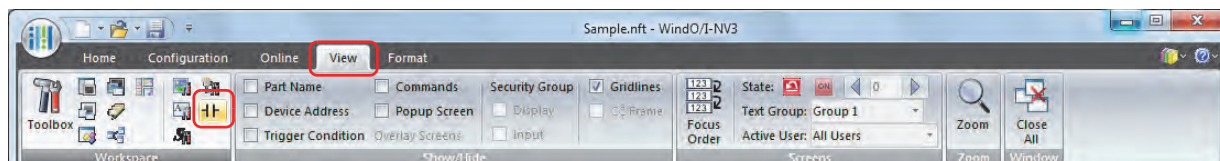

- 2 On the WindLDR **Configuration** tab, in the **Function Area Settings** group, click **Input & Output Configuration**.
The Function Area Settings dialog box is displayed.
- 3 Select **Interrupt Input** in the Groups 1 through 6 pull-down list boxes.
The Interrupt Input dialog box is displayed.

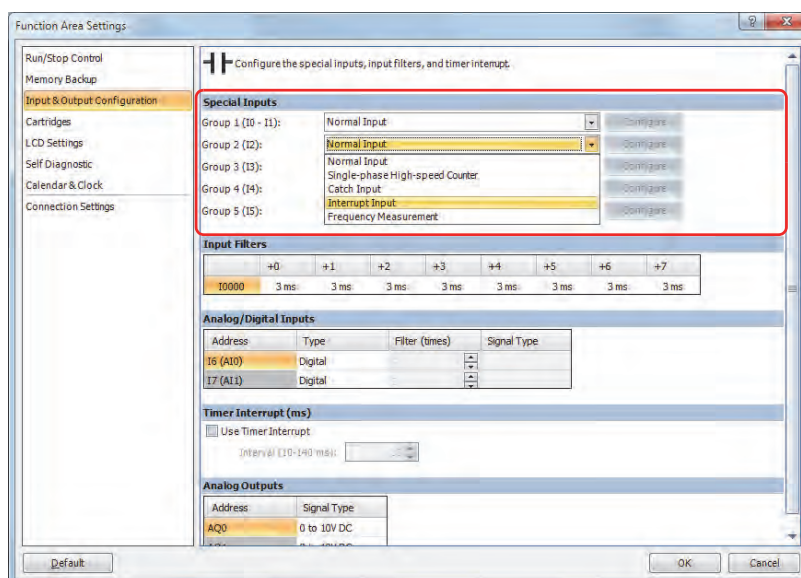

- 4 Select **Interrupt Input Rising Edge**, **Interrupt Input Falling Edge** or **Interrupt Both Edges** in the pull-down list, and then click **OK**.

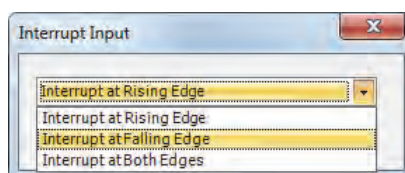

- 5 Click **OK**.
This concludes configuring the settings.

● Example: Interrupt Input

The following example demonstrates a program using the interrupt input function, with input I2 designated as an interrupt input. When the interrupt input is turned on, the input I0 status is immediately transferred to output Q0 using the IOREF (I/O refresh) instruction before the END instruction is executed.

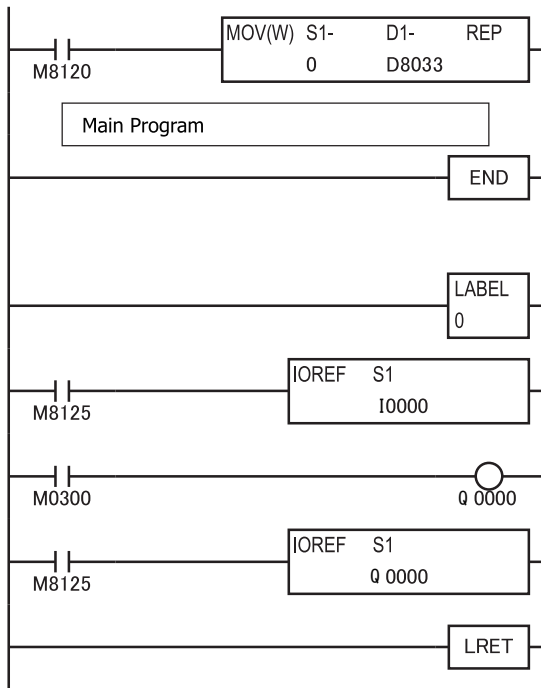

M8120 is the initialize pulse special internal relay.

D8033 stores 0 to designate jump destination label 0 for interrupt input I2.

The interrupt program is separated from the main program by the END instruction.

When input I2 is on, program execution jumps to label 0.

M8125 is the in-operation output special internal relay.

IOREF immediately reads input I0 status to internal relay M0300.

M0300 turns on or off the output Q0 internal memory.

Another IOREF immediately writes the output Q0 internal memory status to actual output Q0.

Program execution returns to the main program.

Insert LRET at the end of the subroutine to return to the main program.



To change input/output information during execution of an interrupt program, use the IOREF (Input/Output Refresh) instruction. The IOREF instruction is used to freely change input/output data before the END scan. For details, refer to Chapter 15 "Refresh Instructions" in "SmartAXIS Ladder Programming Manual".

4.10 Frequency Measurement

This section describes frequency measurement, which measures the input frequency.

● Feature Description

These input pulses are processed in hardware, so frequencies can be measured with no relation to the scan time. Groups that do not use frequency measurement can be used as normal inputs, high-speed counters, catch input, or interrupt input. The measurement results are stored in special data registers and being updated with each scan.

● Function Specification

The Touch inputs can be configured as normal input, high-speed counters, catch input, interrupt input, and frequency measurement. To use frequency measurement, specify the relevant group as **Frequency Measurement** in **Function Area Settings** tab.

The frequency measurement results are stored in the following special data registers. (Read-only)

Any one of Groups 2, 3, 4, or 5 can be freely set.

Inputs 16 and 17 cannot be used for frequency measurement.

Group		1	2	3	4	5
External Input		I0	I2	I3	I4	I5
Frequency measurement value (32 bits)	Upper word	–	D8056	D8068	D8134	D8140
	Lower word	–	D8057	D8069	D8135	D8141
Frequency measurement range		200Hz to 10kHz				
Measurement error		Less than $\pm 1\%$ (Truncated after the decimal point)				
Calculation cycle		Each scan time				



If the input pulse cycle is longer than the scan time, the measurement results are updated at pulse cycle + 1 scan time.

- Procedure

To use frequency measurement, you must configure it in the **Function Area Settings** and download the ladder program or FBD program to the Touch. Frequency measurements will start when you download the ladder program or FBD program and set the Touch to run.

- 1 On the WindO/I-NV3 **View** tab, in the **Workspace** group, click  (Control Function).

WindLDR starts.

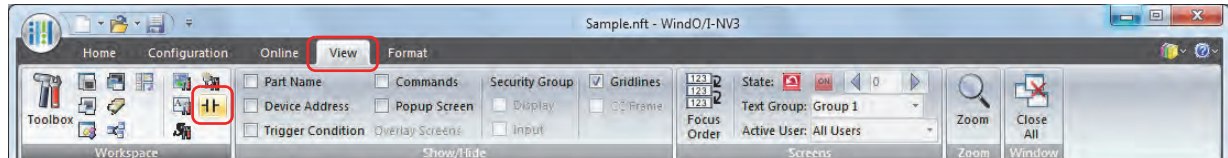

- 2 On the WindLDR **Configuration** tab, in the **Function Area Settings** group, click **Input & Output Configuration**. The Function Area Settings dialog box is displayed.

- 3 Specify **Frequency Measurement** for the group to use frequency measurement.

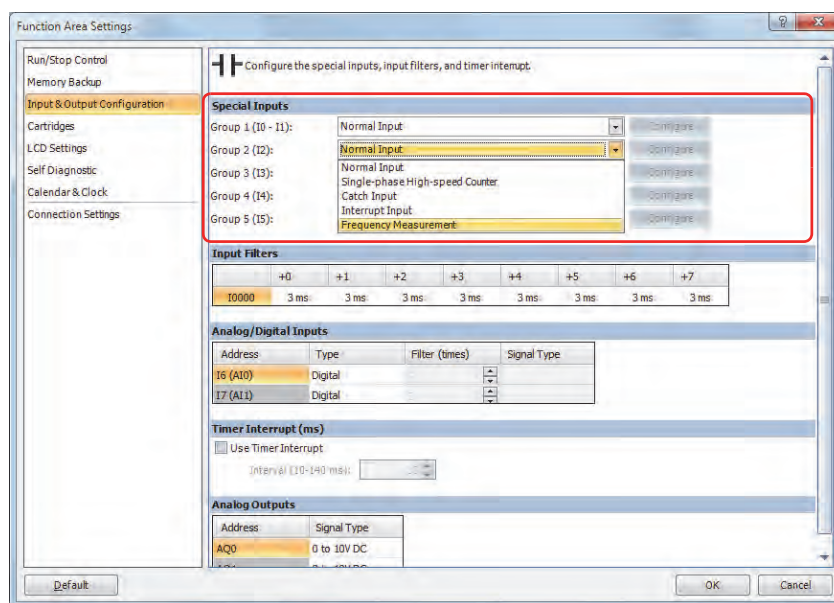

- 4 Click **OK**.

This concludes configuring the settings.

4.11 Input Filter

The input filter function is used to reject input noises. The catch input function described in the preceding section is used to read short input pulses to special internal relays.

● Feature Description

The input filter rejects short input pulses when the Touch is used with input signals containing noises.

Different input filter values can be selected for inputs I0 through I7 in four groups using the Function Area Settings. Selectable input filter values to pass input signals are 0 millisecond, and 3 through 15 milliseconds in 1 millisecond increments. Default value is 3 milliseconds for all inputs I0 through I7. Inputs I10 and above on Touch are provided with a fixed filter of 3 milliseconds.

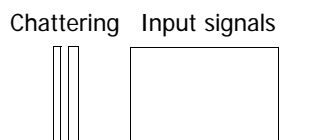

Input Filter Values and Input Operation

Depending on the selected values, the input filter has three response areas to reject or pass input signals.

- Input signals : Input signals do not pass the filter (selected filter value minus 2 milliseconds).
- Pass area : Input signals pass the filter (selected filter value).
- Indefinite area : Input signals may be rejected or passed.

The input filter rejects inputs shorter than the selected input filter value minus 2 milliseconds.

Example: Input Filter

To reject input pulses of 6 milliseconds or less, select input filter value of 8 milliseconds. Then input pulses of 8 milliseconds plus one scan time are accepted correctly at the END processing.

6 msec		8 msec
Rejected	Indefinite	Accepted



- Signals that pass through input filters are not necessarily captured as inputs. Normal inputs require a pulse width of the filter value plus one scan time to receive input signals.
- If external inputs are set as high-speed counters, interrupt inputs, frequency measurement, or analog inputs, input filters are disabled.

● Procedure

- 1 On the WindO/I-NV3 **View** tab, in the **Workspace** group, click  (Control Function).

WindLDR starts.

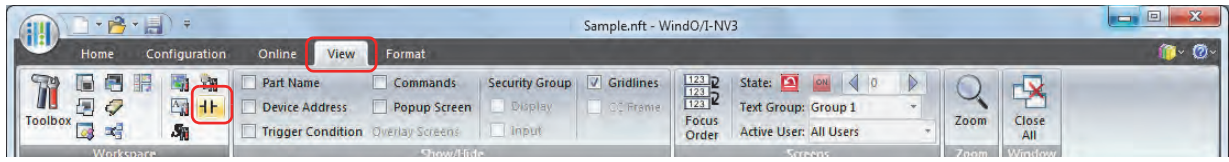

- 2 On the WindLDR **Configuration** tab, in the **Function Area Settings** group, click **Input & Output Configuration**. The Function Area Settings dialog box is displayed.
- 3 If an input to which an input filter is applied is not a normal input, select **Normal Input** in the corresponding group.
- 4 Select an input filter value for each group of inputs.

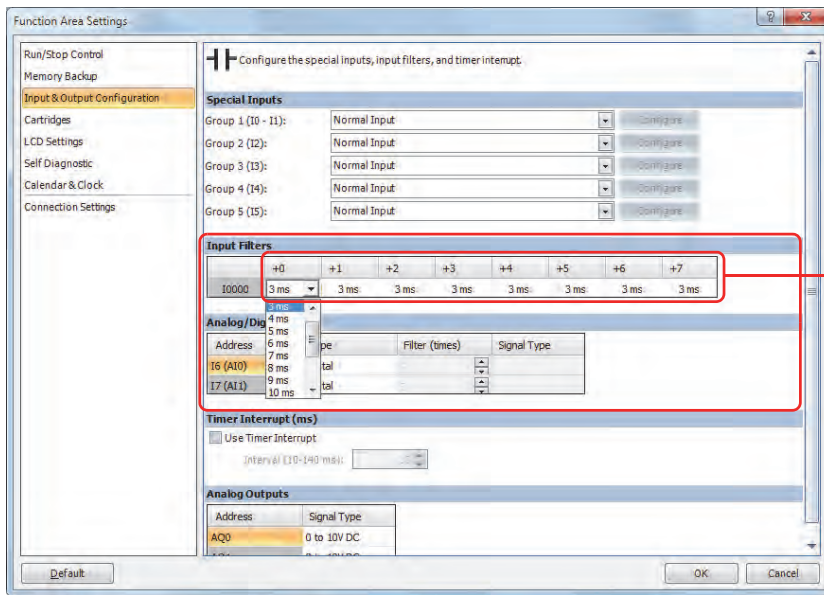

The columns displayed next to 10000 indicate I0 to I7.

- 5 Click **OK**.

This concludes configuring the settings.

4.12 Analog Input

This section describes how to configure analog input signals such as those from pressure sensors.

● Feature Description

The Touch is equipped with two analog inputs.

The FT1A-*12RA-* accepts analog input of 0 to 10V DC by converting it to 0 to 1000 digital values.

The FT1A-*14KA-* and the FT1A-*14SA-* accepts analog input of 0 to 10V DC or 4 to 20 mA by converting it to 0 to 1000 digital values. The converted analog input values are stored in special data registers. Inputs that are not specified as analog inputs are digital inputs. For the on or off judgment threshold value when digital input is specified, refer to Chapter 29 "SmartAXIS Specifications" on page 29-1.

● Applicable Models

The type analog input that can be used varies based on the model.

Analog input	FT1A-*14KA-* FT1A-*14SA-*	FT1A-*12RA-*
0 to 10 V	YES	YES
4 to 20 mA	YES	NO

● Storage Locations for the Analog Input Value and Analog Input Status

The Touch has two embedded analog inputs. The digitally converted analog input values are stored in special data registers (D8040 and D8041: read-only) as values between 0 and 1,000. The analog input status is also stored in special data registers (D8042, D8043, and D8077: read-only). These values are updated with each scan.

Analog input terminal	A10	A11
Special data register that stores the analog input value	D8040	D8041
Special data registers that store the analog input status	D8077 D8042	D8077 D8043

■ Analog Input Status (D8077)

If the analog input signal exceeds 11 V or 21 mA, the corresponding bit of D8077 turns on to indicate overflow. For details, refer to Chapter 27 "2.2 Control Device Addresses" on page 27-12.

■ Analog Input Status (D8042, D8043)

Details on the analog input status (D8042, D8043) are as follows.

Status	Description	Analog input value
0	Operating normally	Current analog input value
1	Converting data (occurs only once during the initial conversion when the power is turned on)	Undefined value
2	Initializing	0
3	Parameter setting error	Correct value immediately before the error occurred
4	Reserved	—
5	Wiring fault (out of maximum range) Analog input signals exceed 11 V, or 21 mA	Maximum
6	Wiring fault (out of minimum range, open current loop) Analog input signals fall below 2 mA	Minimum
7 to 65535	Reserved	—

● Analog Input Filter

The analog input data is averaged by the specified filter count. This can reduce rapid fluctuations in analog input. The larger the filter value set, the slower the tracking of the change in analog input becomes.

Count	Description
0	No filtering
1 to 255	The input value is set as the average value of n samples of analog input value. (n: Count)

When filtering, the input value is calculated with the equation below.

$$\text{Analog input value after filtering} = \frac{\text{Total analog input values for filter count (n) worth of scans}}{\text{Filter count n}}$$

● Analog Input Allocation

Input	I0	...	I5	I6	I7
Analog input terminal	–	–	–	A10	A11
Special data register that stores analog input value	–	–	–	D8040	D8041
Special data registers that store analog input status	–	–	–	D8077 D8042	D8077 D8043

- Procedure

To use analog input, you must configure the **Function Area Settings** tab and download the ladder program or FBD program to the Touch.

- 1 On the WindO/I-NV3 **View** tab, in the **Workspace** group, click  (Control Function).

WindLDR starts.

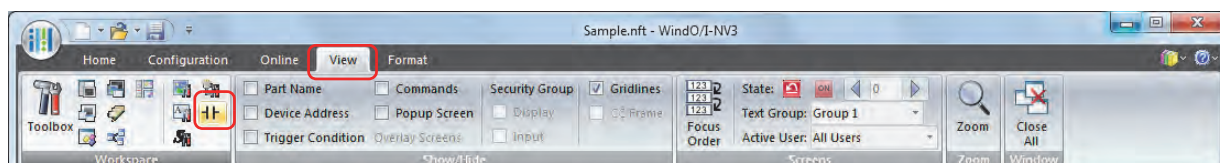

- 2 On the WindLDR **Configuration** tab, in the **Function Area Settings** group, click **Input & Output Configuration**. The Function Area Settings dialog box is displayed.

- 3 Under **Type** for the external input to use as an analog input, select **Analog**.

- 4 Under **Filter (times)**, specify the number of times to filter, and under **Signal Type**, select **0 to 10V DC** or **4 to 20mA DC**.

Click **Default** to set all the external inputs to digital.

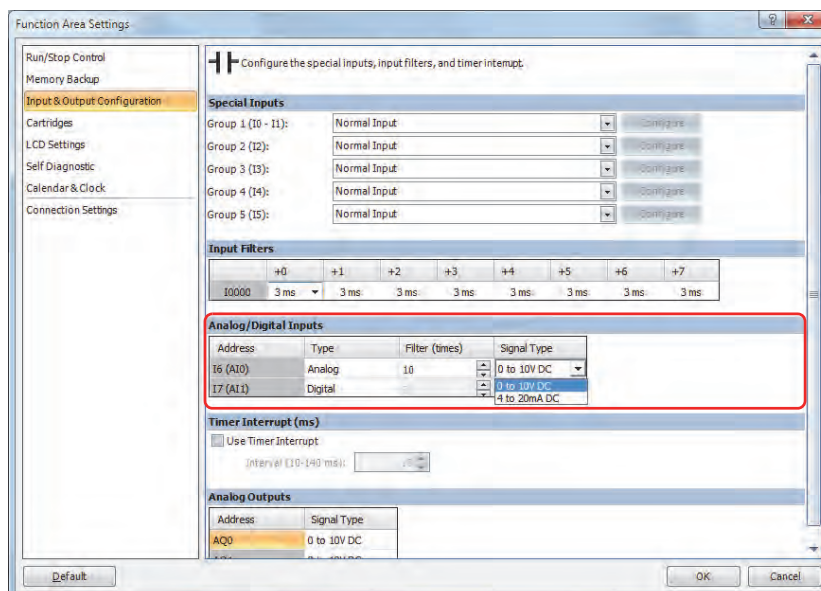

- 5 Click **OK**.

This concludes configuring the settings.

4.13 Timer Interrupt

This section describes the timer interrupt that executes the interrupt program at a regular time interval. The timer interrupt can only be used when ladder program is selected as the programming language.

● Feature Description

The timer interrupt is a function that executes a subroutine program with a predetermined label number as the interrupt program at a regular time interval. The Function Area Settings dialog box is used to enable the timer interrupt and to specify the interval, from 10 to 140 milliseconds, to execute the timer interrupt. When the timer interrupt is enabled, the program execution jumps to the jump destination label number stored in special data register D8036 repeatedly while the Touch is running.

D8036	Timer Interrupt Jump Destination Label No.	R/W
-------	--	-----



A label is the starting address of the program branch to jump to, and it is specified by the LABEL instruction.

● Disable and Enable Interrupts

The timer interrupt is normally enabled while the Touch is running, and can also be individually disabled using the DI instruction or enabled using the EI instruction. When timer interrupt is enabled, Touch is turned on. When disabled, Touch is turned off.

For details, refer to Chapter 16 "Interrupt Control Instructions" in "SmartAXIS Ladder Programming Manual".

● Notes for Using Timer Interrupt and Interrupt Inputs

- When using a timer interrupt or interrupt input, separate the interrupt program from the main program using the END instruction at the end of the main program.
- When an interrupt program calls another subroutine, a maximum of 3 subroutine calls can be nested. If more than 3 calls are nested, a ladder program execution error occurs.
- The label numbers stored in data registers D8036 specify the interrupt programs for interrupt inputs I2, I3, I4, and I5 and timer interrupt, respectively.
- If an interrupt is initiated while another interrupt program is executed, the subsequent interrupt program is executed after the prior interrupt is completed. Multiple interrupt programs cannot be executed simultaneously.
- Make sure that the execution time of the interrupt program is shorter than interrupt intervals sufficiently.
- Interrupt programs cannot use some instructions. For details, refer to Chapter 12 "2.2 Instructions Reference" on page 12-14.

● Procedure

To use timer interrupt, you must configure it in the **Function Area Settings** in WindLDR and download the ladder program to the Touch.

- 1 On the WindO/I-NV3 **View** tab, in the **Workspace** group, click  (Control Function).
WindLDR starts.

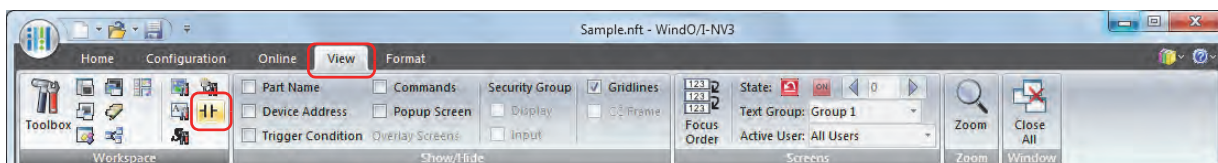

- 2 On the WindLDR **Configuration** tab, in the **Function Area Settings** group, click **Input & Output Configuration**.
The Function Area Settings dialog box is displayed.
- 3 Select the **Use Timer Interrupt** check box.

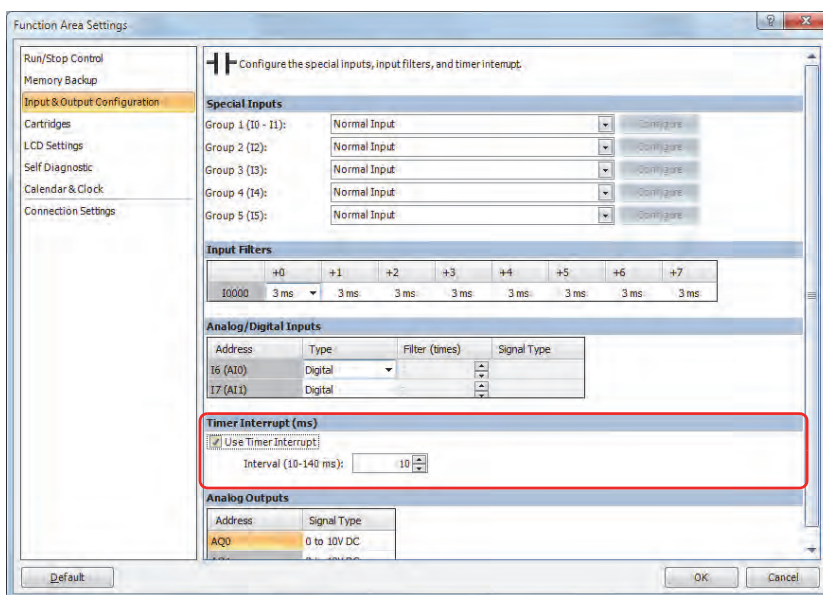

- 4 Specify an interval to execute the timer interrupt.
- 5 Click **OK**.

This concludes configuring the settings.

● Example: Timer Interrupt

The following example demonstrates a program of using the timer interrupt function. The Function Area Settings must also be completed to use the timer interrupt function as described on the preceding page.

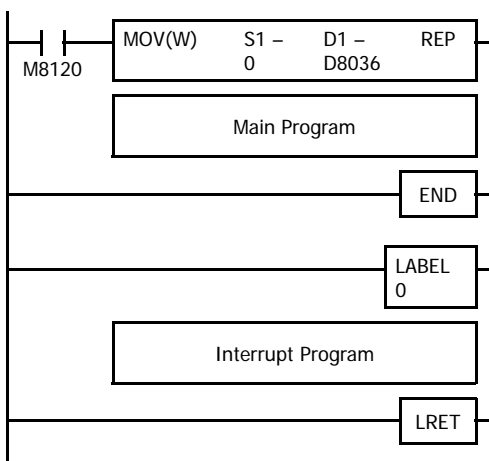

M8120 is the initialize pulse special internal relay.

D8036 stores 0 to designate jump destination label 0 for timer interrupt.

The interrupt program is separated from the main program by the END instruction.

While the SmartAXIS is running, program execution jumps to label 0 repeatedly at intervals selected in the Function Area Settings. Each time the interrupt program is completed, program execution returns to the main program at the address where timer interrupt occurred.

Insert LRET at the end of the subroutine to return to the main program.

4.14 Analog Output

This section describes how to configure analog output signals for voltage and current.

● Feature Description

The FT1A-*14KA-* and the FT1A-*14SA-* are equipped with two analog outputs. This function converts 0 to 10 V DC or 4 to 20 mA analog signals into 0 to 1,000 increment and stored in special data registers.

The FT1A-*12RA-* does not have analog output function.



In the cases below, the minimum value of analog output is written to the special data registers for the analog outputs.

- When the Touch is reset, such as when the Touch is powered up.
- When Ladder program or FBD program is in STOP state and M8025 (Maintain Outputs While Program Operation Stopped) is OFF.

● Applicable Models

Analog output	FT1A-*14KA-* FT1A-*14SA-*	FT1A-*12RA-*
0 to 10 V	YES	–
4 to 20 mA	YES	–

● Storage Location for the Analog Output Value and Status

The analog output values (0 to 1,000) stored in the special data registers (D8044 and D8045) are converted to analog signals by the scan end processing in the ladder program or FBD program, and then output from AQ0 and AQ1. The analog output status is also stored in special data registers (D8046 and D8047: read-only). These values are updated with each scan.

Analog output terminal	AQ0	AQ1
Analog output value	D8044	D8045
Analog output status	D8046	D8047

■ Analog Output Status (D8046, D8047)

Details on the analog output status are as follows.

Status	Description	Analog output signal
0	Operating normally	Current analog output value
1	Reserved	–
2	Initializing	0 V / 4 mA
3	Parameter setting error	Analog output value immediately before the error occurred
4 to 9	Reserved	–
10	Set to unused for the Signal Type	–
11	Analog outputs unsupported model (FT1A-*12RA-*) has been selected	–
12 to 65535	Reserved	–



For input FB and output FB in FBD programs, only analog value input (AI FB) is supported. Analog value output is not supported. To output analog values in FBD programs, store the analog output value in the relevant special data register (D8044, D8045, D8176, D8177, D8186, D8187) using script programming.

● Procedure

To use analog output, you must configure it in the **Function Area Settings** tab and download the ladder program or FBD program to the Touch.

- 1 On the WindO/I-NV3 **View** tab, in the **Workspace** group, click  (Control Function).

WindLDR starts.

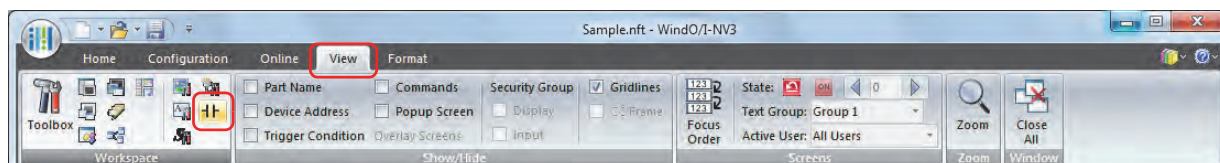

- 2 On the WindLDR **Configuration** tab, in the **Function Area Settings** group, click **Input & Output Configuration**. The Function Area Settings dialog box is displayed.

- 3 Under **Signal Type** for the external output to use as the analog output, select **0 to 10V DC** or **4 to 20mA DC**.

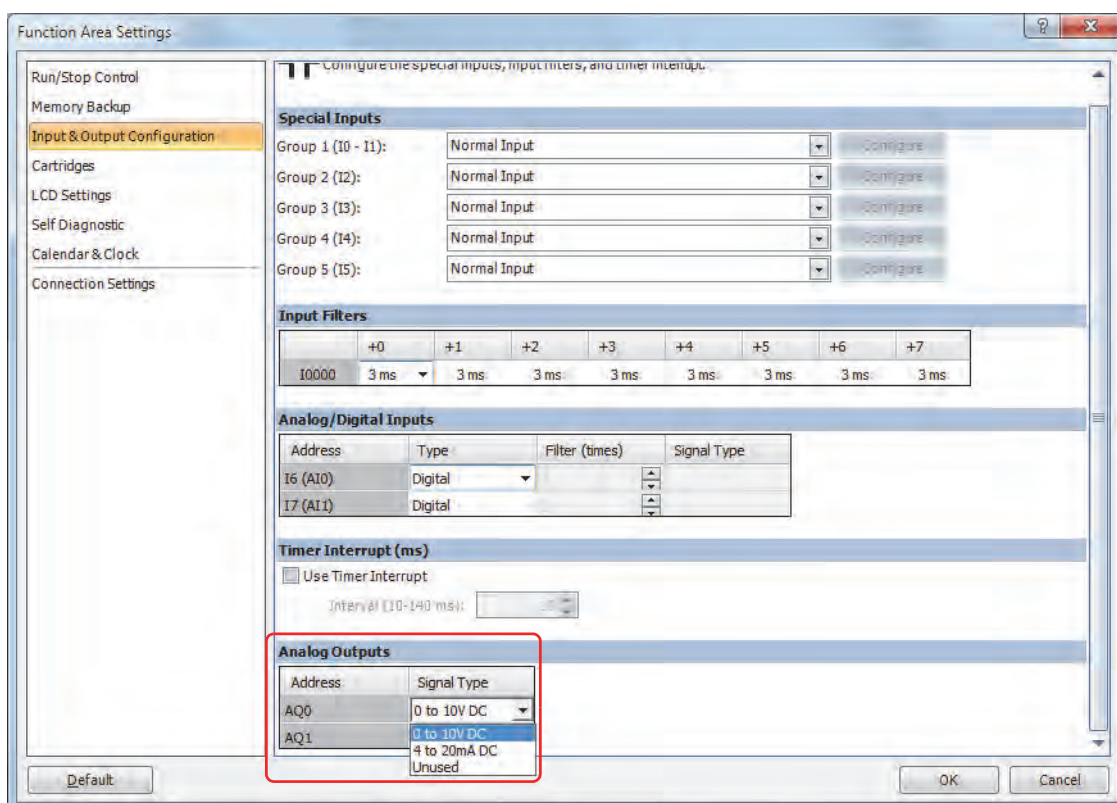

- 4 Click **OK**.

This concludes configuring the settings.

4.15 Analog Cartridge

This section describes the analog cartridge settings.

● Feature Description

The FT1A-*14KA-* and the FT1A-*14SA-* are equipped with two slots used for attaching analog cartridges. A maximum of two analog cartridges can be used, and by attaching these analog cartridges, the Touch can be expanded to a maximum of 2in/6out, 4in/4out, or 6in/2out analog I/O.

Select the analog cartridges for the external devices and set the operation mode. The analog value and analog status for each channel are stored in special data registers.



In the cases below, the minimum value of analog output is written to the special data registers for the analog outputs.

- When the Touch is reset, such as when the Touch is powered up.
- When Ladder program or FBD program is in STOP state and M8025 (Maintain Outputs While Program Operation Stopped) is OFF.

! CAUTION

- Always turn the Touch off before removing or installing the analog cartridge. If the analog cartridge is inserted or removed with the power on, there is a risk of the product failure. Touch operation cannot be guaranteed.
- The analog cartridge may be damaged if dropped. Be careful not to drop it when removing it.
- Correctly attach the analog cartridges in the slots.

● Applicable Models

Only the FT1A-*14KA-* and the FT1A-*14SA-* are capable of supporting analog cartridges.

The FT1A-*12RA-* does not support analog cartridges.

Analog cartridge	FT1A-*14KA-* FT1A-*14SA-*	FT1A-*12RA-*
FC6A-PJ2A	YES	–
FC6A-PJ2CP	YES	–
FC6A-PK2AV	YES	–
FC6A-PK2AW	YES	–

● Analog Cartridge Specifications

- The analog cartridges are available in the analog input type and analog output type.

The analog input type is called the analog input cartridge, and the analog output type is called the analog output cartridge.

- The analog input cartridge is available in two types, voltage/ current input type (FC6A-PJ2A) and temperature input type (FC6A-PJ2CP). A single analog input cartridge has two analog inputs, and each channel can be set to a different operation mode.
- The analog output cartridge is available in two types, voltage output type (FC6A-PK2AV) and current output type (FC6A-PK2AW). A single analog output cartridge has two analog outputs, and the operation mode is common to both.
- To use an analog cartridge, it must be configured in the **Function Area Settings** tab in Control Functions.
- The analog input/output value for each analog cartridge channel are stored in special data registers. For details, refer to “Storage Location for the Analog Value and Analog Status” on page 3-92.

Type Number Configuration

The type, number of analog inputs or outputs, and operation modes by analog cartridge type number are as follows.

Type No.	Type	Number of points	Operation mode		Digital Resolution
FC6A-PJ2A	Analog input	2 points	Voltage	0 to 10V DC	4,096 increments (12bit)
			Current	0 to 20 mA	
				4 to 20 mA	
FC6A-PJ2CP	Analog input	2 points	Thermocouple	Type K	15,000 increments (14bit)
				Type J	12,000 increments (14bit)
				Type R	17,600 increments (15bit)
				Type S	17,600 increments (15bit)
				Type B	18,200 increments (15bit)
				Type E	10,000 increments (14bit)
				Type T	6,000 increments (13bit)
				Type N	15,000 increments (14bit)
				Type C	23,150 increments (15bit)
			Resistance thermometer (RTD)	Pt100	10,500 increments (14bit)
				Pt1000	8,000 increments (13bit)
				Ni100	2,400 increments (12bit)
			Ni1000	2,400 increments (12bit)	
FC6A-PK2AV	Analog output	2 points	Voltage	0 to 10V DC	4,096 increments (12bit)
FC6A-PK2AW	Analog output	2 points	Current	4 to 20 mA	4,096 increments (12bit)

Checking the Version Number

The analog cartridge version number is printed on the side of the analog cartridge in the location in the following diagram. The performance and functionality of the analog cartridge will differ by its version, so check the version number before use.

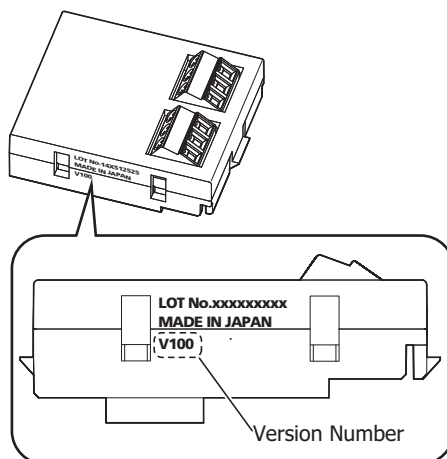

● Analog I/O Allocation

The analog inputs or analog outputs expanded by using an analog cartridge are allocated as follows.

	Touch		Analog cartridge			
			Port 1		Port 2	
Channel	–	–	CH0	CH1	CH0	CH1
Analog number (AI/AQ)	0	1	2	3	4	5

Allocation example

Example 1: When an analog input cartridge is attached to analog cartridge port 1 and an analog output cartridge is attached to analog cartridge port 2

	Touch		Analog cartridge			
			Port 1		Port 2	
Channel	–	–	CH0	CH1	CH0	CH1
Analog input	AIO	AI1	A12	A13	–	–
Analog output	AQ0	AQ1	–	–	AQ4	AQ5

Example 2: When an analog input cartridge is only attached to analog cartridge port 2

	Touch		Analog cartridge			
			Port 1		Port 2	
Channel	–	–	CH0	CH1	CH0	CH1
Analog input	AIO	AI1	–	–	AI4	AI5
Analog output	AQ0	AQ1	–	–	–	–

● Operation Setup Parameters

The analog cartridge settings are configured for each channel.

The setup parameters include the operation mode, filter, data type, minimum and maximum values, data, and status.

Operation mode

The operation mode that can be selected varies based on the analog cartridge model. Select the analog cartridge that corresponds to the user application and set the operation mode.

For details on the operation modes, refer to "Analog Cartridge Specifications" on page 3-88.

Filter

The analog input of analog cartridge reaches approximately 99% of analog input in the specified filter time by filtering. You can decrease rapid fluctuations in the analog input by setting the filter time, but increasing the filter time makes tracking for fluctuations in the analog input slower.

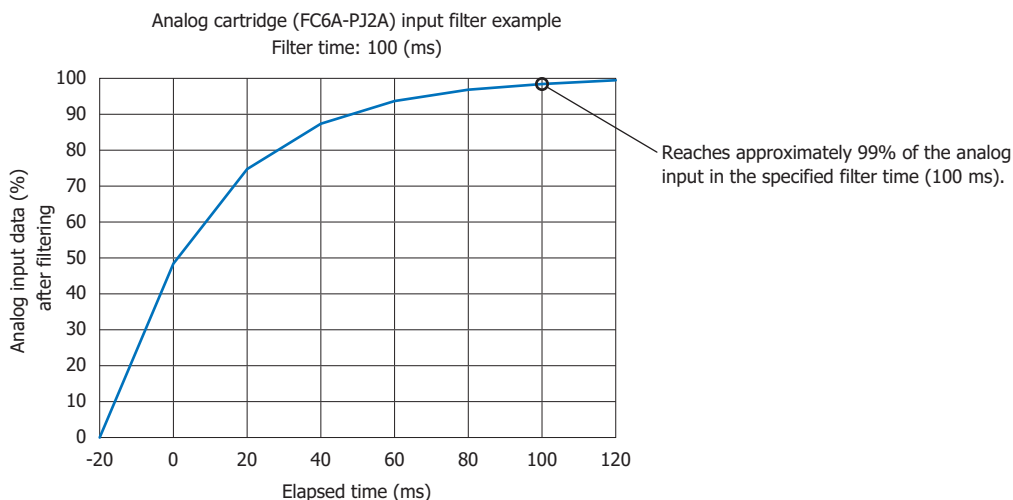

Description

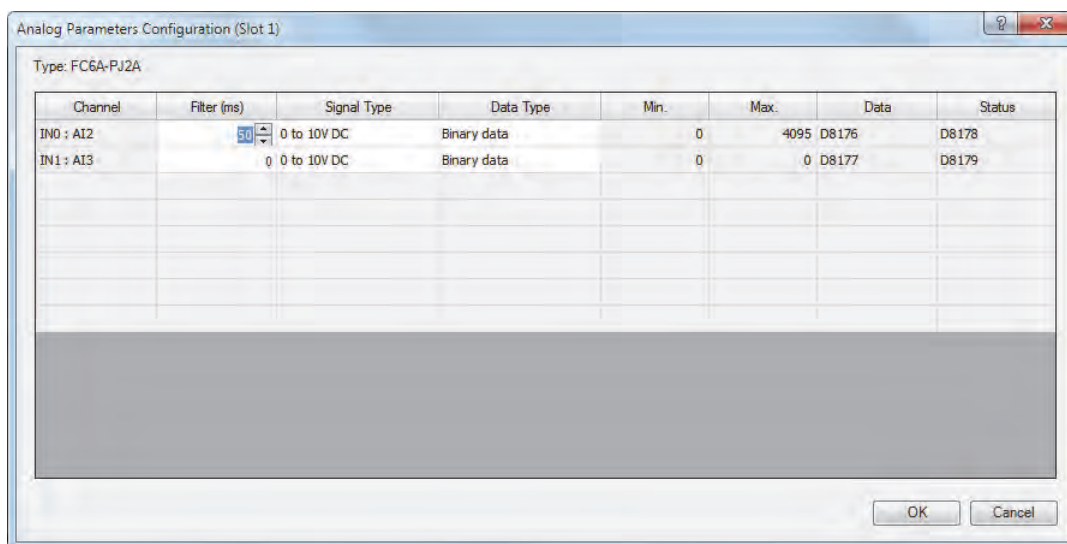

Filter time (ms)	Description
0	No filtering
50 to 50000	Set the analog input filter time in 50 ms increments. Approximately 99% of the analog input is reached in the specified filter time by filtering.

Data type

The analog value can be handled in the range of the specified data type (minimum to maximum values). The data types are as follows.

Data Type	Description
Binary data	Analog values can be handled in the range of 0 to 4,095.
Optional range	Analog values can be handled in the range of minimum to maximum values. The minimum and maximum values can be set in the range of -32,768 to 32,767. For the minimum and maximum values, refer to the analog value linear conversion minimum and maximum.
Celsius	Analog values can be handled in the linear conversion range of the temperature sensor set in the data type. For details, refer to the analog input value linear conversion range when set to Celsius or Fahrenheit.
Fahrenheit	

Analog Value Linear Conversion Minimum and Maximum

When **Data Type** is set to **Optional range**, these values set the minimum and maximum values when performing a linear conversion of the analog value. The minimum and maximum values can be set to any value in the range of -32,768 to 32,767. However, the minimum value must be set to a value smaller than the maximum value.

Analog Input Value Linear Conversion Range When Set to Celsius or Fahrenheit

When data type is set to Celsius or Fahrenheit, the analog input value is linearly converted in the range in the following table.

Operation mode		Celsius		Fahrenheit	
		Temperature (°C)	Analog input value	Temperature (°F)	Analog input value
Thermocouple	Type K	-200 to 1,300	-2000 to 13,000	-328 to 2,372	-3280 to 23,720
	Type J	-200 to 1,000	-2000 to 10,000	-328 to 1,832	-3280 to 18,320
	Type R	0 to 1,760	0 to 17,600	32 to 3,200	320 to 32,000
	Type S	0 to 1,760	0 to 17,600	32 to 3,200	320 to 32,000
	Type B	0 to 1,820	0 to 18,200	32 to 3,308	320 to 33,080
	Type E	-200 to 800	-2000 to 8,000	-328 to 1,472	-3280 to 14,720
	Type T	-200 to 400	-2000 to 4,000	-328 to 752	-3280 to 7,520
	Type N	-200 to 1,300	-2000 to 13,000	-328 to 2,372	-3280 to 23,720
	Type C	0 to 2,315	0 to 23,150	32 to 4,199	320 to 41,990
Resistance thermometer (RTD)	Pt100	-200 to 850	-2000 to 8,500	-328 to 1,562	-3280 to 15,620
	Pt1000	-200 to 600	-2000 to 6,000	-328 to 1,112	-3280 to 11,120
	Ni100	-60 to 180	-600 to 1,800	-76 to 356	-760 to 3,560
	Ni1000	-60 to 180	-600 to 1,800	-76 to 356	-760 to 3,560

Storage Location for the Analog Value and Analog Status

The special data registers that store the analog value and analog status for the analog inputs or analog outputs expanded by using an analog cartridge are allocated as follows. These values are updated with each scan.

Analog input terminal/analog output terminal	AI2/AQ2	AI3/AQ3	AI4/AQ4	AI5/AQ5
Analog value	D8176	D8177	D8186	D8187
Analog status	D8178	D8179	D8188	D8189



- The value of special data registers for channels that are not used is undefined.
- If the filter is enabled on an analog input, the value after being filtered is stored in the special data register.
- The analog value and analog status are updated in the scan end processing. The special data register values are updated regardless of whether the Touch is stopped or running.

Analog status

The operational status of the analog input or analog output is indicated for each channel. If the status is 0, this means the value is normal as an analog value.

■ Analog input

Status	Description				Analog input value
0	Operating normally				Current analog input value
1	Converting data (occurs fro approximately 500 ms after the power is turned on and after the user program is downloaded.)				Undefined value
2	Initializing				0
3 to 4	Reserved				–
5	Wiring error (out of the maximum ranger)				
	Signal type	Voltage	DC 0 to 10 V	For V100 ^{*1} : 10.0 V or higher For V201 ^{*1} and later: 10.2 V or higher	Maximum value
		current	DC 4 to 20 mA	For V100 ^{*1} : 20.0 mA or higher For V201 ^{*1} and later: 20.32 mA or higher	
			DC 0 to 20 mA	For V100 ^{*1} : 20.0 mA or higher For V201 ^{*1} and later: 20.4 mA or higher	
Thermocouple/ Resistance thermometer (RTD)	The input maximum value or greater. The maximum value varies by the signal type. For details, refer to “Analog Input Value Linear Conversion Range When Set to Celsius or Fahrenheit” on page 3-92.				
6	Wiring error (out of the maximum ranger, open current loop)				
	Signal type	Voltage	DC 0 to 10 V	For V100 ^{*1} : 0 V or lower For V201 ^{*1} and later: -0.2 V or lower	Minimum value
		current	DC 4 to 20 mA	For V100 ^{*1} : 4.0 mA or lower For V201 ^{*1} and later: 3.68 mA or lower	
			DC 0 to 20 mA	For V100 ^{*1} : 0 mA or lower For V201 ^{*1} and later: 0 mA or lower	
Thermocouple/ Resistance thermometer (RTD)	The input minimum value or smaller. The minimum value varies by the signal type. For details, refer to “Analog Input Value Linear Conversion Range When Set to Celsius or Fahrenheit” on page 3-92.				
7	Reserved				–
8	The setting in the ladder program/ FBD program differs from the attached analog cartridge				Undefined value
9	The analog cartridge has not been attached				Undefined value
10	The analog cartridge has been attached, but it is set to unused for the Type				Undefined value
11	Analog cartridge unsupported model (FT1A-*12RA-*) has been selected				Undefined value
12 to 65535	Reserved				–

*1 The analog cartridge version number is printed on the side of the analog cartridge. For details, see “Checking the Version Number” on page 3-89.

■ Analog output

Status	Description	Analog output signal
0	Operating normally	Current analog output value
1	Reserved	–
2	Initializing	0 V / 4 mA
3	Parameter setting error	Analog output value immediately before the error occurred
4 to 7	Reserved	–
8	The setting in the ladder program or FBD program differs from the attached analog cartridge	0 V / 4 mA
9	The analog cartridge has not been attached	–
10	The analog cartridge has been attached, but it is set to unused for the Type	0 V / 4 mA
11	Analog cartridge unsupported model (FT1A-*12RA-*) has been selected	–
12 to 65535	Reserved	–



For input FB and output FB in FBD programs, only analog value input (AI FB) is supported. Analog value output is not supported. To output analog values in FBD programs, store the analog output value in the relevant special data register (D8044, D8045, D8176, D8177, D8186, D8187) using a script.

● Procedure

To use analog cartridges, you must configure it in the **Function Area Settings** tab and download the ladder program or FBD program to the Touch.

- 1 On the WindO/I-NV3 **View** tab, in the **Workspace** group, click **⇧** (Control Function).

WindLDR starts.

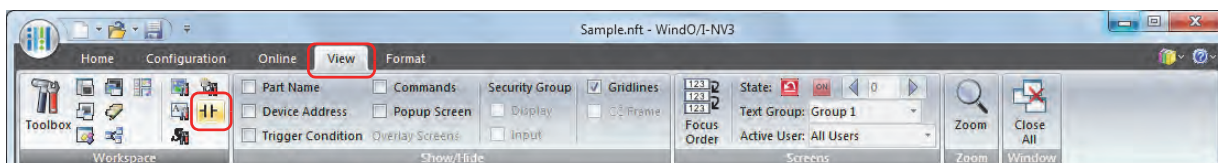

- 2 On the WindLDR **Configuration** tab, in the **Function Area Settings** group, click **Cartridges**.

The Function Area Settings dialog box is displayed.

- 3 Under **Type** for the **Slot** where the analog cartridge is connected, select the type of analog cartridge.

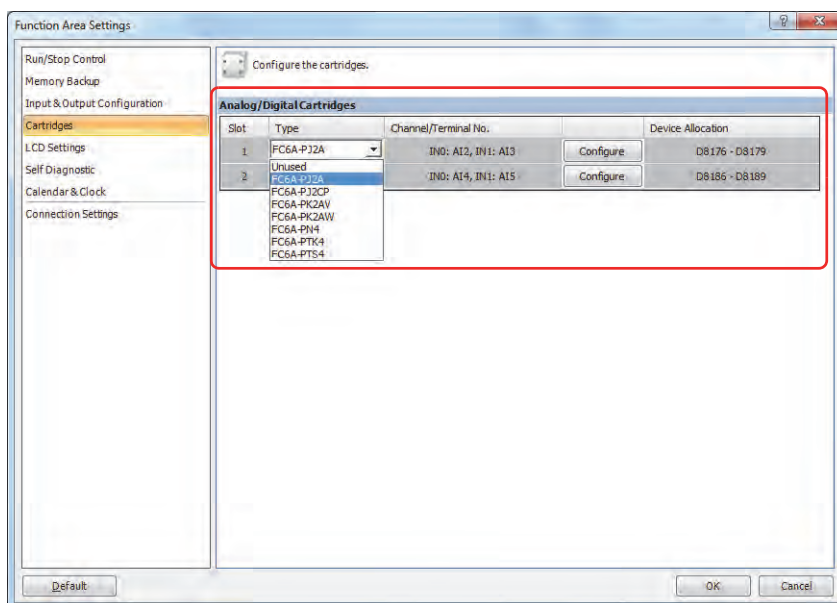

- 4 Click **Configure** for the **Slot** where the analog cartridge is connected.

The Analog Parameters Configuration dialog is displayed. All of the parameters for the analog cartridge can be configured in this dialog box. The detailed settings vary based on the type of analog cartridge.

- 5 Enter the filter preset value.

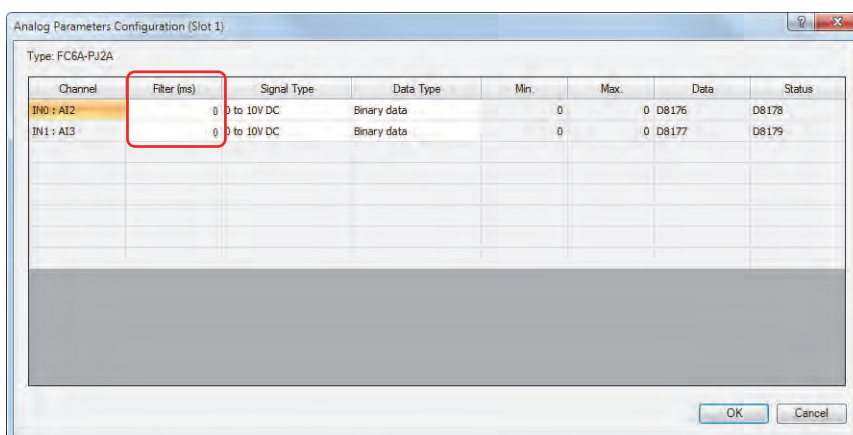

- 6 Under **Signal Type**, select analog input type for each channel.

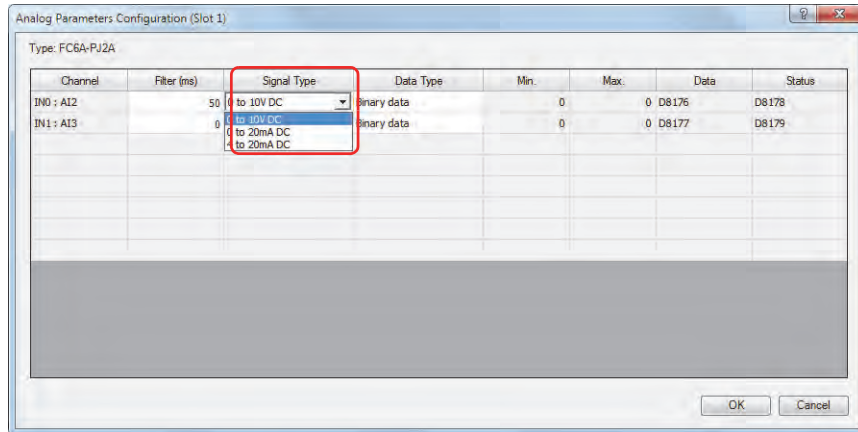

- 7 Under **Data Type**, select the data type for each channel.

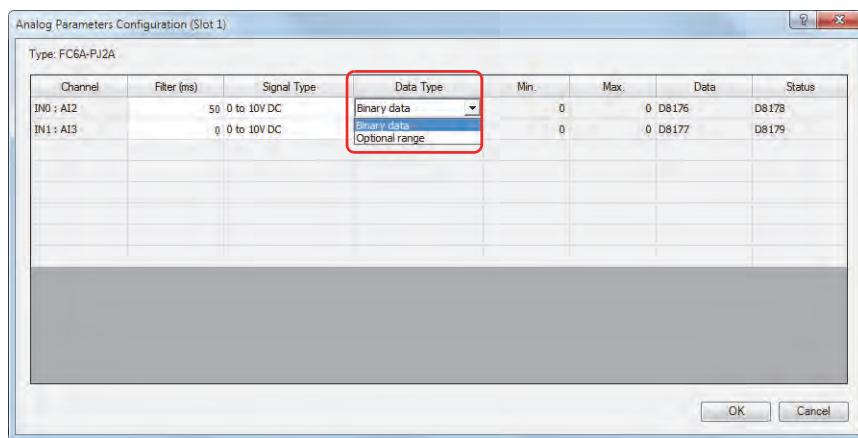

- 8 If **Optional range** is selected for **Data Type**, set the minimum and maximum of analog value for each channel in the range of -32,768 to 32,767.

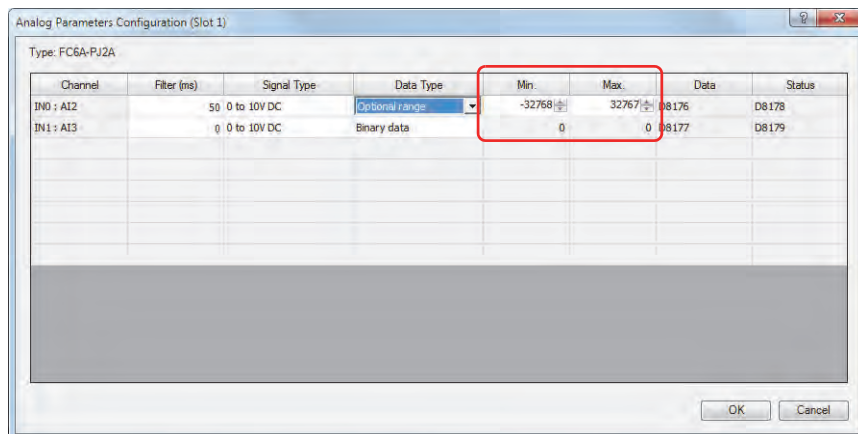

- 9 Click **OK** to close the Analog Parameters Configuration dialog box.

- 10 Click **OK**.

This concludes configuring the settings.

4.16 Ladder Monitor

This section describes the function to monitor the ladder program on the LCD of the Touch.

The program monitor on the Touch is only enabled when ladder program is selected as the programming language.

● Feature Description

Two lines of the ladder program stored in the ROM can be displayed on the LCD. You can show the ladder program at the specified line number by specifying it using the operation buttons. The Touch saves the monitored ladder line when ladder program monitoring is finished, and you can resume to monitor the ladder program from the same ladder line.

You can display the details of instruction parameters or switch the on/off state of contacts using the operation buttons. The ladder program can be monitored regardless of the Run/Stop status of the Touch.



- The default value of the previously monitored ladder line number is one.
- The previously monitored ladder line number is lost at the following conditions:
 - Touch is powered up.
 - A project is downloaded to the Touch.

In order to monitor the ladder program on the LCD of the Touch, you need to configure settings using WindLDR.

There are two restrictions in creating the ladder programs that can be displayed on the LCD. Create ladder programs considering those restrictions.

- A maximum of four ladder lines can be programmed in each ladder circuit.
- A maximum of eleven instructions can be programmed in each ladder line.

● Procedure

- 1 On the WindO/I-NV3 **View** tab, in the **Workspace group**, click  (Control Function).

WindLDR starts.

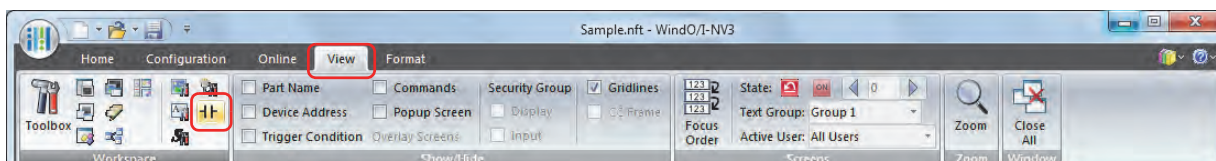

- 2 On the WindLDR **Configuration** tab, in the **Function Area Settings** group, click **LCD Settings**.

The Function Area Settings dialog box is displayed.

- 3 Select the **Enable ladder program monitoring on FT1A** check box.

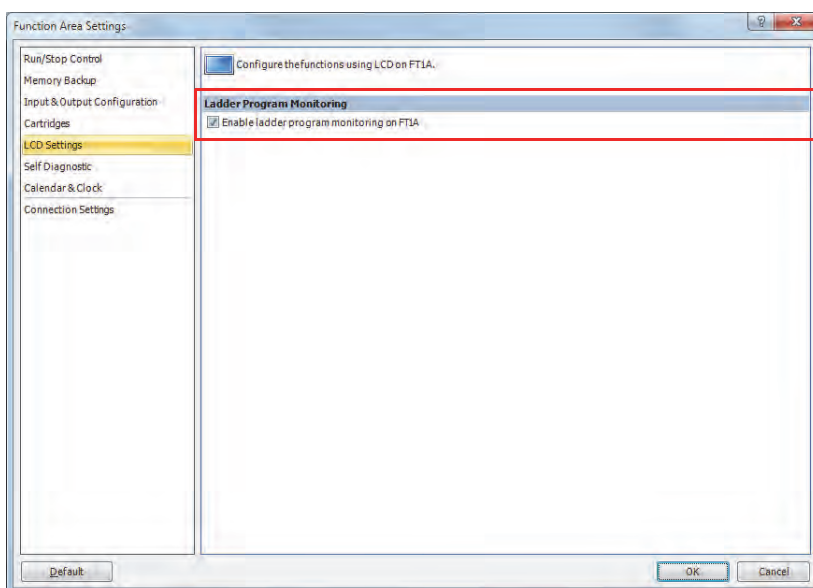

- 4 Click the **OK** button.

This concludes configuring the settings.

4.17 Watchdog Timer Setting

This section describes watchdog timer setting with monitoring the operation state of the Touch.

● Feature Description

A watchdog error occurs when the processing time for one scan exceeds the allowed time while the ladder program or FBD program is running.

If a watchdog error occurs, the system is reset with the purpose of returning the system to normal operation.

If the watchdog error occurs frequently, you can assume that there is a hardware problem and that the Touch requires replacement.

Some of the reasons why a watchdog timer will occur are problems with the Touch hardware and the length of the processing time in the ladder program. If the processing time for one scan of the ladder program exceeds the time configured for the watchdog timer on the ladder program, place a NOP (no operation) instruction in the ladder program. The watchdog timer is reset when the NOP instruction is executed.

For FBD program, the watchdog timer cannot be reset in the program.

Watchdog timer setting time

The watchdog timer setting time can be changed in the function area settings. Decide on the watchdog timer setting time in either of the following two ways.

- Decide by user system specification

Determine the maximum on time (milliseconds) so the output signals do not stay on if the Touch loses control and set that value as the watchdog timer setting time. However, if the ladder program processing time takes longer than the design specification, use an NOP (no operation) instruction in the ladder program. For example, when the watchdog timer is set to 100 milliseconds and the maximum value for one scan is 120 milliseconds on the ladder program, insert an NOP instruction in the ladder logic program to ensure that the error does not occur.

- Match the ladder program processing time

Check the maximum value for one scan (D8024) and set the watchdog timer value as a value with a safety margin added to the maximum value.



Select the watch dog timer setting between 100 milliseconds and 5,000 milliseconds. The default time is 400 milliseconds.



When changing the watchdog timer setting value, select an appropriate value that fully takes into consideration the safety of the system.

The ladder program or FBD program execution time can be checked with the value of LSD38.

● Procedure

- 1 On the WindO/I-NV3 **View** tab, in the **Workspace** group, click  (Control Function).

WindLDR starts.

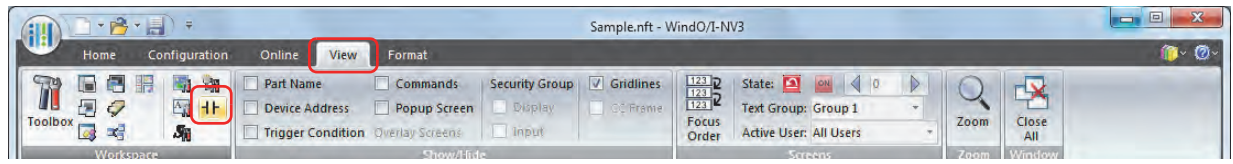

- 2 On the WindLDR **Configuration** tab, in the **Function Area Settings** group, click **Self Diagnostic**.

The Function Area Settings dialog box is displayed.

- 3 Select the preset value for watchdog timer.

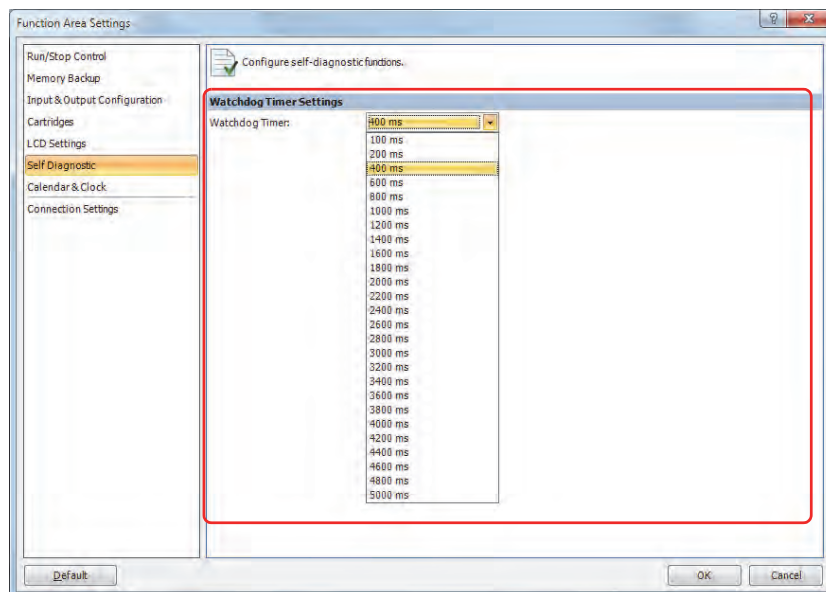

- 4 Click **OK**.

This concludes configuring the settings.

4.18 Daylight Savings Time

This section describes the function that automatically adjusts the Touch real time clock according to the daylight savings time settings.

● Feature Description

For regions where the Touch is used that implement daylight savings time, this function can automatically adjust the Touch clock using the daylight savings time settings. When the time becomes the daylight savings time start time, the clock is set an hour forward. When the time becomes the the daylight savings time end time, the clock is set an hour back.

The Touch adjusts the clock for daylight savings time on the start day and the end day. However, the clock is also adjusted for daylight savings time under the following conditions.

- When a ladder program or FBD program was downloaded to the Touch.
- When the Touch power is turned on.

When the current time of the Touch internal clock is set using System Area or special data registers, the time is not adjusted for daylight savings time, even if the time after it was set is within the daylight savings time period. Set the clock to the time adjusted for daylight savings time. The set date and time becomes the date and time after being adjusted for daylight savings time.

● Procedure

Configure daylight savings time on the Touch.

- 1 On the WindO/I-NV3 **View** tab, in the **Workspace** group, click  (Control Function). WindLDR starts.

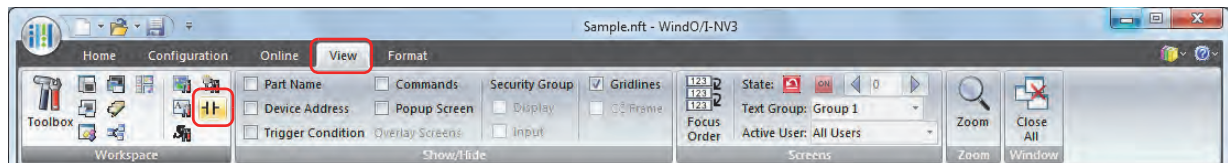

- 2 On the WindLDR **Configuration** tab, in the **Function Area Settings** group, click **Calendar & Clock**. The Function Area Settings dialog box is displayed.
- 3 Select the **Enable Daylight Saving Time** check box.

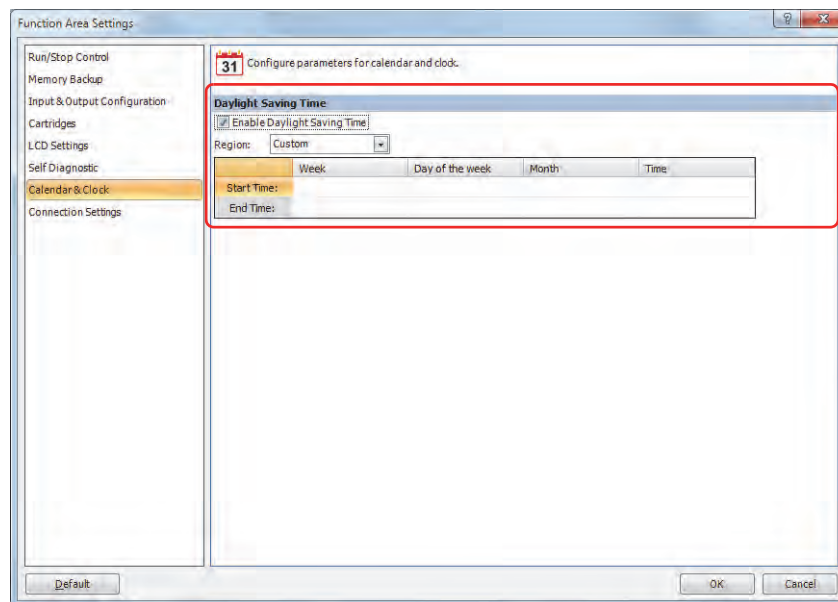

- 4 Configure the start time and the end time. Specify the region using the **Region** list box. If you select **Custom**, you are able to select any desired start time and end time.

Region	Start time	End time
Custom	User specified	User specified
USA or Canada	March, 2nd Sunday, 2:00 AM	November, 1st Sunday, 2:00 AM
Europe	March, last Sunday, 1:00 AM	October, last Sunday, 1:00 AM
Australia	October, 1st Sunday, 2:00 AM	April, 1st Sunday, 3:00 AM

- 5 Click **OK**.
This concludes configuring the settings.

4.19 Clock Function

This section describes the internal clock function on the Touch.

● Feature Description

This function enable you to control time based applications such as lighting or air conditioning equipment using the current time data stored in special data registers. The internal clock data is backed up by a secondary lithium battery. The current time is reset when the backup data is lost, so the current time will need to be set again.

Function	Description	
Read clock	The current time (calendar, clock) is updated every 500 milliseconds and automatically stored in the special data registers.	
Set clock	Sets the current time (calendar, clock). Uses the System Area or special data registers.	
Adjust function	When clock data adjust flag M8021 is turned on from off, the seconds for the current time are rounded up or rounded down based on 30 seconds to correct the seconds data for the internal clock. If the current seconds are between 0 and 29 seconds, the seconds are set to 0 when M8021 is turned on from off. If the current seconds are between 30 and 59 seconds, the minutes are set to + 1 and the seconds are set to 0 when M8021 is turned on from off.	
Calendar/clock error	M8013:	This relay turns on if clock write processing or a clock adjust processing could not be executed normally.
	M8014:	This relay turns on if an error occurs while calendar/clock data is read from the internal clock to the special data registers (D8008 to D8014).

● Adjusting the Date and Time with WindLDR

Set the current time on the Touch with WindLDR.

Procedure

- 1 On the WindO/I-NV3 **View** tab, in the **Workspace** group, click  (Control Function).

WindLDR starts.

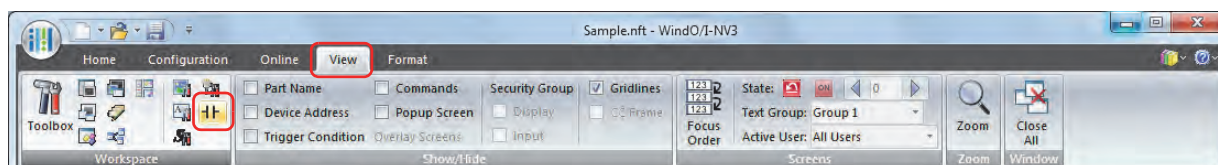

- 2 On the WindLDR **Monitor** tab, click **Monitor**.
- 3 On the **Online** tab, in the **PLC** group, click **Status**.

The PLC Status dialog box is displayed.

- 4 Click **Change** for **Calendar**.

The Set Calendar and Time dialog box is displayed. The current time on the computer is displayed in the dialog box as the initial value. The settings can also be changed as necessary.

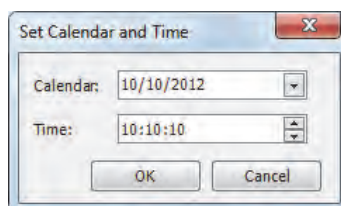

- 5 Click **OK**.

The date and time configured in the dialog box is written to the Touch.

● **Adjusting the Date and Time with Ladder Program or FBD Program**

The current time can be set on the Touch by using special data registers D8015 to D8021. Undefined values are stored in special data registers D8015 to D8021. Always store an appropriate value before turning on M8016, M8017, or M8020.

■ **Calendar Data Write Flag (M8016)**

After writing data to special data registers D8015 to D8018, turn M8016 on to set the internal clock with the data in D8015 to D8018 as the calendar data (year, month, day, day of the week).

■ **Clock Data Write Flag (M8017)**

After writing data to special data registers D8019 to D8021, turn M8017 on to set the internal clock with the data in D8019 to D8021 as the clock data (hour, minute, second).

■ **Calendar/Clock Data Write Flag (M8020)**

After writing data to special data registers D8015 to D8021, turn M8020 on to set the internal clock with the data in D8015 to D8021 as the calendar data (year, month, day, day of the week) and the clock data (hour, minute, second).

Calendar and clock data storage locations

The calendar/clock data is stored in the following special data registers.

Special data register	Description	Range	Setting timing
D8008	Calendar/Clock Current Data (Read only)	Year	0 to 99
D8009		Month	1 to 12
D8010		Day	1 to 31
D8011		Day of the week	0 to 6
D8012		Hour	0 to 23
D8013		Minute	0 to 59
D8014		Second	0 to 59
D8015	Calendar/Clock New Data (Write only)	Year	0 to 99
D8016		Month	1 to 12
D8017		Day	1 to 31
D8018		Day of the week	0 to 6
D8019		Hour	0 to 23
D8020		Minute	0 to 59
D8021		Second	0 to 59

Every 500 msec
If the scan time is 500 msec
or longer, D8008 to D8014 are
updated with each scan.

–

For the day of the week data, the values below are stored in the special data registers.

Day of the week	Sunday	Monday	Tuesday	Wednesday	Thursday	Friday	Saturday
Value	0	1	2	3	4	5	6

● Example ladder program 1

This example sets the calendar and clock in a ladder program.

If you turn on M8020 with the new calendar/clock data set in the write-only data registers D8015 to D8021, the internal clock on the Touch is updated with the current time (calendar, clock). In this example, the Touch internal clock is set to 9:35:00 on Tuesday February 21, 2012.

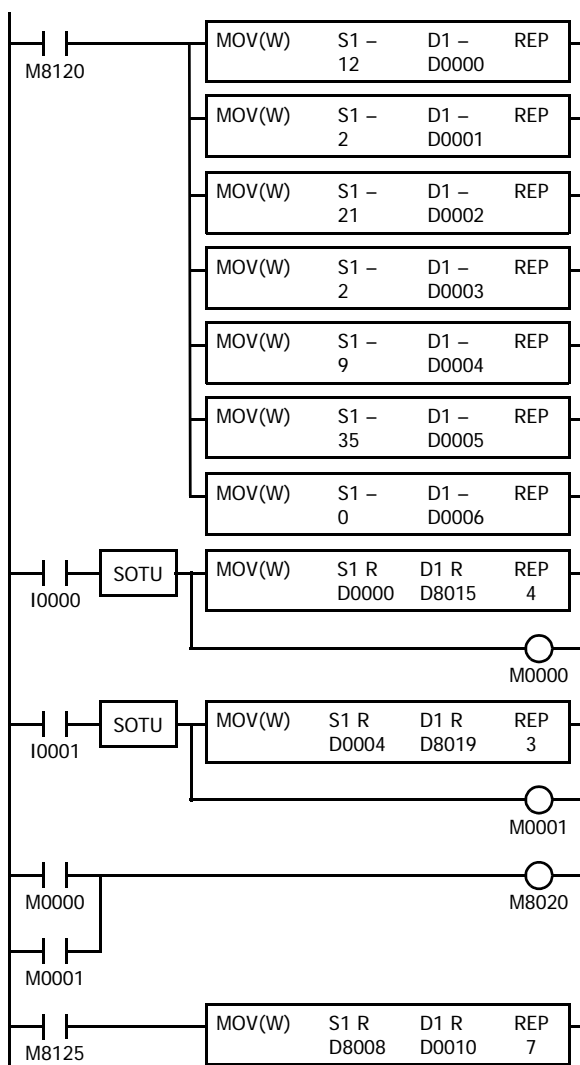

M8120 is the initialize pulse that turns on for only one scan at the start of operation.

When the Touch starts operating, the new calendar/clock data is stored in D0000 to D0006 with the MOV (move) instruction.

When external input I0000 turns on, the new calendar data is stored in special data registers D8015 to D8018. Internal relay M0000 turns on for one scan only.

When external input I1 turns on, the new clock data is stored in special data registers D8019 to D8021. Internal relay M0001 turns on for one scan only.

When external input M0000 or M0001 turns on, M8020 turns on and the calendar/clock data is written to the internal clock.
(M8020: Calendar/Clock Data Write Flag)

M8125 is a special internal relay that is always on during operation.

While the Touch is running, the current time (calendar, clock) is stored in D0010 to D0016 with the MOV instruction.

● Example ladder program 2

When I1 turns on, the seconds on the internal clock are corrected to 0 seconds.

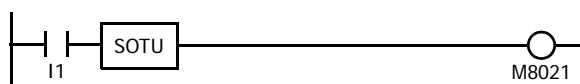

When input I1 turns on, clock data adjust flag M8021 turns on to correct the seconds on the internal clock.



The internal clock backup time is approximately 30 days (25°C TYP). If the power loss time exceeds the backup time, the retained clock data is lost and the current time is initialized as 00:00:00 on January 1, 2000.

4.20 Connection Settings

This section describes the configurations of client/server communication for TCP/IP communication related to the SmartAXIS control function.

● Feature Description

The SmartAXIS control function is capable of performing remote I/O communication over the Ethernet port using a maximum of three connections.

The connection settings required for performing communication are configured in the Function Area Settings dialog box.

The remote I/O master can be configured for a maximum of three connections as the communication mode used with each connection.

For details on the remote I/O function, refer to Chapter 12 "4 Remote I/O" on page 12-46.

● Connection Status Information and Connected IP Address

The connection status with an external device can be confirmed with special internal relays M8110 to M8112. The When a connection is established with the server, the corresponding special internal relay is turned on. When the connection is disconnected, the corresponding special internal relay is turned off. The IP addresses of the devices can be confirmed with special data registers D8110 to D8121.

■ Status Information

Special internal relay	Description		Read/write
M8110	Connection 1 Status	While a connection is established with the server or client device, the special internal relay will be on. When no connection is established, it will be off.	R
M8111	Connection 2 Status		
M8112	Connection 3 Status		

■ Connected IP Addresses

Special data register	Description		Read/write
D8110 to D8113	Connection 1 Connected IP Address	The IP address is stored in the corresponding special data registers as follows. Example: IP Address: aaa.bbb.ccc.ddd, D8110=aaa, D8111=bbb, D8112=ccc, D8113=ddd	R
D8114 to D8117	Connection 2 Connected IP Address		
D8118 to D8121	Connection 3 Connected IP Address		

- Procedure

To perform remote I/O communication using a connection, you must configure the **Function Area Settings** tab and download the ladder program or FBD program to the Touch.

- 1 On the WindO/I-NV3 **View** tab, in the **Workspace** group, click  (Control Function).

WindLDR starts.

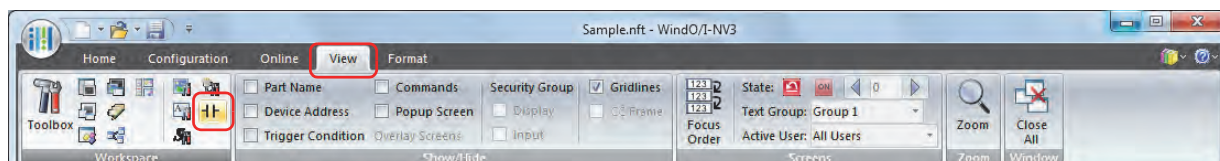

- 2 On the WindLDR **Configuration** tab, in the **Function Area Settings** group, click **Connection Settings**.

The Function Area Settings dialog box is displayed.

- 3 Select **Communication Mode** for the connection to use.

The settings dialog box for the set communication mode is displayed.

As an example here, **Communication Mode** is set to **Remote I/O Master**.

Configure the communication mode allocated to a maximum of three connections.

Set connections that are not used to **Unused**.

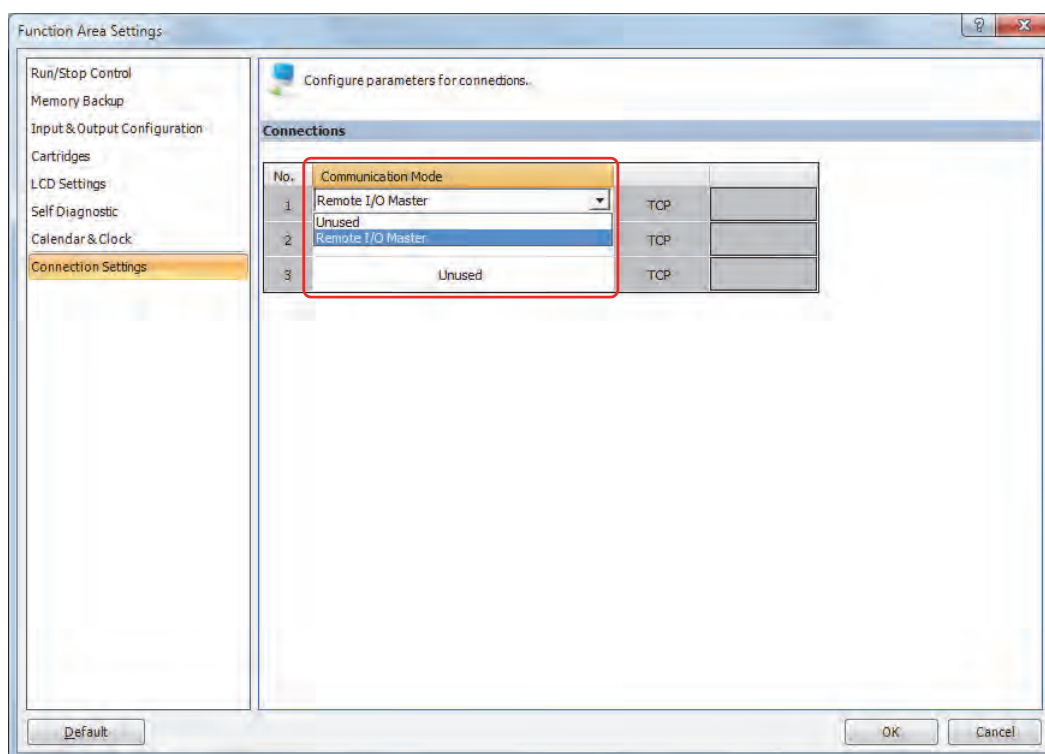

- 4 Specify the parameters.

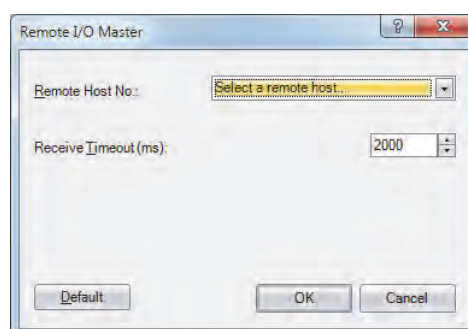

- 5 Click **OK**.

This concludes configuring the settings.

4.21 Remote Host List

This section describes the remote host list to register and manage the external devices (remote hosts) to communicate with on the network.

● Feature Description

When using the following Ethernet communication functions on the Touch, you must register the connections to communicate with as remote hosts.

- Remote I/O master

When a remote host is registered, a remote host number is automatically allocated to it.

When using the function listed above, specify the remote host number as the device to communicate with.

● Procedure

- 1 On the WindO/I-NV3 **View** tab, in the **Workspace** group, click  (Control Function).

WindLDR starts.

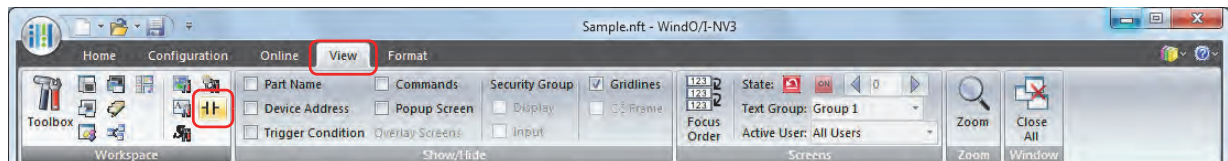

- 2 On the WindLDR **Project** window, double-click **Remote Host List**.

The Remote Host List dialog box is displayed.



If the **Project** window is not displayed, on the **View** tab, in the **Workspace** group, click **Project Window** to display the **Project** window on the left side of the screen.

- 3 Click **New**.

The Remote Host dialog box is displayed.

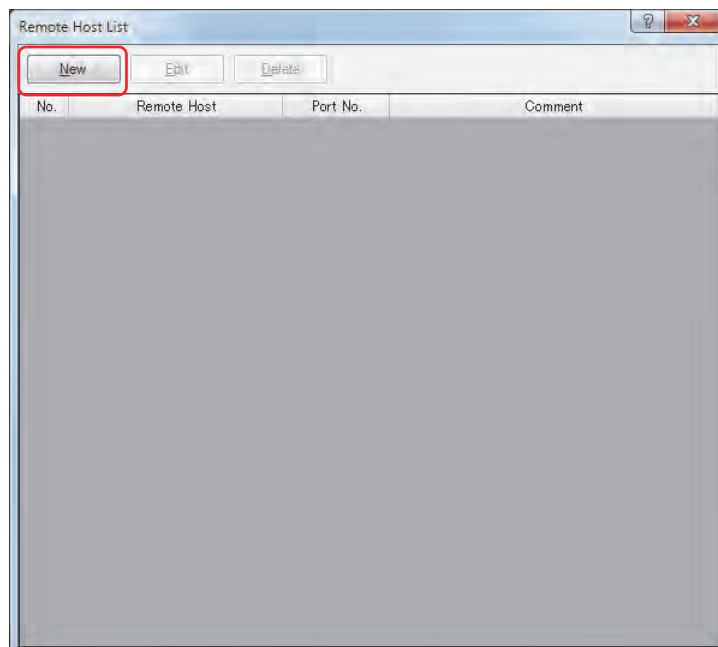

4 Enter the items on the Remote Host dialog.

The Remote Host dialog box is displayed.

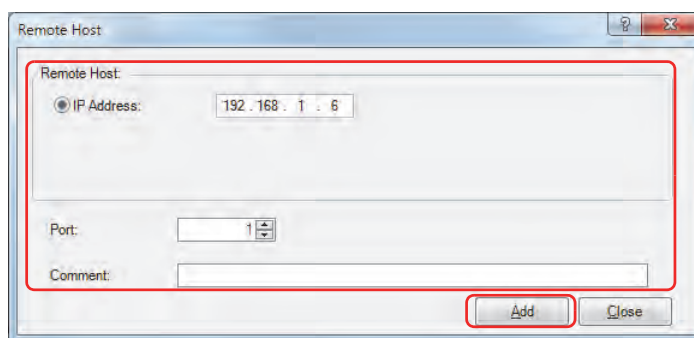

The remote host is composed of two elements, **IP Address** and **Port**.

IP Address: Specify the remote host with an IP address. The Touch performs communication by establishing a connection to the specified IP address and port number.

Port: Specify the port number used in TCP/IP communication.

Comment: The comment for the remote host can be assigned. The contents or the length of the comment has no effect on communication.

5 Click **Add**.

The remote host is registered and reflected in the remote host list.

To register another remote host, repeat the procedure in steps 4 and 5.

6 When you have finished registering all of the remote hosts, click **Close**.

7 Click (Close).

The Remote Host List dialog box closes.

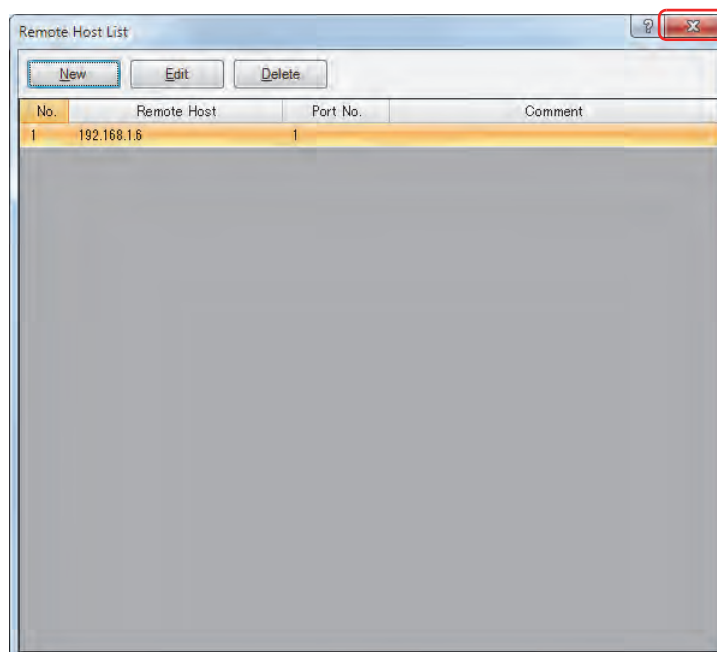

This concludes configuring the settings.



To delete a registered remote host, select the remote host to delete in the Remote Host List dialog box, and click **Delete**.

Once a remote host is deleted, the remote host numbers of the following remote hosts are changed. This will affect the operation of remote I/O masters that refer to these remote host numbers.

5 Project Restrictions

5.1 Download Restrictions

■ Project Data Size

The size of the project data that can be downloaded to the Touch is approx. 5 MB max (including additional fonts).



- To check the project data size, on the **Home** tab, in the **Project** group, click **Target Info**. The Target Information dialog box is displayed. The project data size can be checked with **Memory Space (byte)** under **Target Runtime Information**.
- The project data size varies based on the fonts downloaded to the Touch. For details, refer to Chapter 2 "Font Size" on page 2-8.

■ Number of Parts

The number of parts that can be downloaded to the Touch are as follows.

Parts	Number of parts
Total number of Bit Buttons, Word Buttons, Goto Screen Buttons, Multi Buttons, Key Buttons	32,000 max.
Selector switches	200 max.

5.2 Maximum Number of External Devices

■ Project

The maximum number of external devices used in global script trigger conditions, user communication trigger conditions, and global scripts that can be used in a single set of project data is 100 devices.



If the same device address is used in multiple device settings, the number of used devices is counted as one. It is not counted as one device per device setting.

■ Data Log Settings

A maximum of 128 external devices can be used in the Data Log settings.



Even if the same device address is used in multiple device settings, the number of used devices is counted as one device for each device setting.

■ Scripts

The restrictions on the number of external devices that can be used in a single script are as follows.

Item	Number of devices
Destination external devices	64 max.
Source external devices	64 max.



If the same device address is used in multiple device settings, the number of used devices is counted as one. It is not counted as one device per device setting.

Chapter 4 Screen

This chapter provides an overview of the Touch screen and describes how to setup and operate the screen.

1 Screen Overview

1.1 Screen Types

The types of screens can be created with the WindO/I-NV3 are given below.

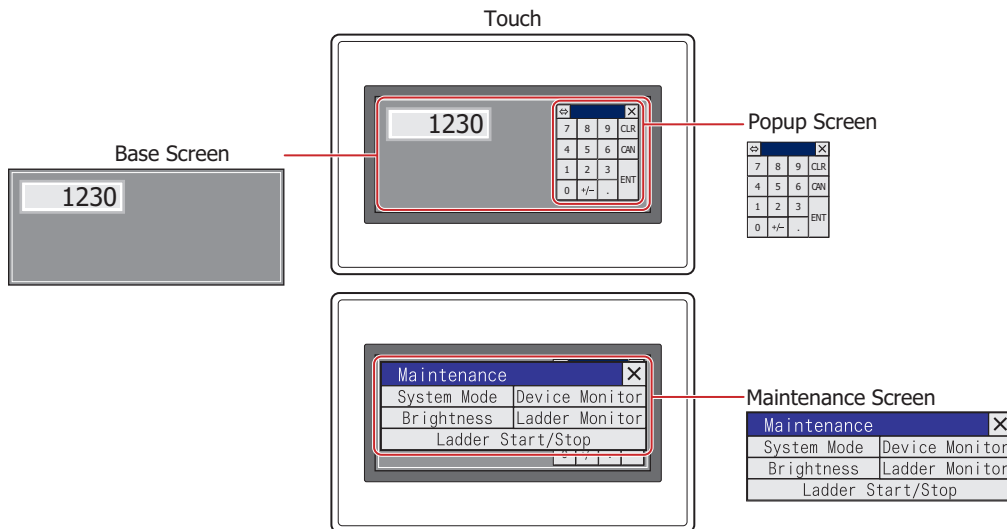

Screen Type		Screen No.	Description
Screens that can be created with WindO/I-NV3	Base Screen	1 to 3,000	The screen that is displayed when the Touch is in Run Mode. Drawing objects and functional parts can be created mainly on this screen which is displayed on the Touch.
	Popup Screen	1 to 3,015	The Popup Screen that is displayed on the Base Screen when the Touch is in Run Mode. The size and coordinates of the screen can be specified and this screen can also be moved on the Base Screen. A Popup Screen for the standard Keypad*1 will automatically be created in screen numbers 3,001 to 3,015.
	Library Screen	-	The screen that registers often used drawing objects and parts to the set WindO/I-NV3. References the registered screen while the project is being edited and can copy and appropriate drawing objects and parts from the screen. This screen is not included in project data.
Screen provided by the Touch	Maintenance Screen	-	Using the screen that is displayed when the Touch is in Run Mode, you can switch from Run Mode to System Mode and load a screen to adjust Device Monitor and screen brightness. For details, refer to Chapter 28 "1 Maintenance Screen" on page 28-1.

1.2 Screen Size

The size of the Base Screen is equal the size of the Touch screen. The Base Screen size is 240 x 100 dots.

*1 The Keypad that is displayed when operating Numerical and Character Input parts when **Standard** is selected under **Type** in the **Keypad** menu for Numerical and Character Input parts.

2 Creating and Manipulating WindO/I-NV3 Screens

2.1 Creating Screens

This section describes how to create Base Screens and Popup Screens.

- Creating a screen

- 1 On the **Home** tab, in the **Screens** group, click the arrow under **New**.
- 2 Click **Base Screen** or **Popup Screen**.

The Screen Properties dialog box is displayed.

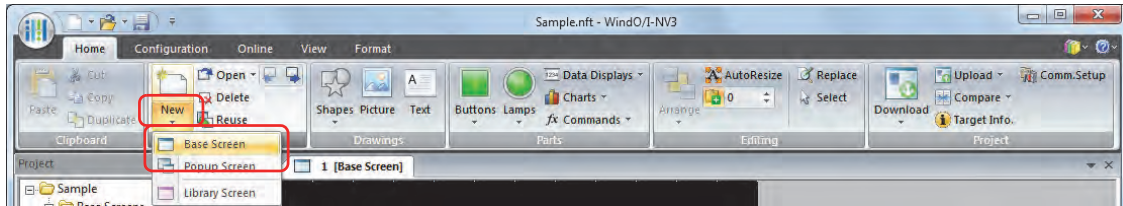

To edit the properties for a Base Screen or Popup Screen that has already been created, double click an area in the editing window with no objects.

- 3 Change the settings on each tab as necessary, and then click **OK**.

2.2 Opening Screens

- Opening a screen

You can open a single screen that has already been created.

Double click the screen to open in the **Project** window.

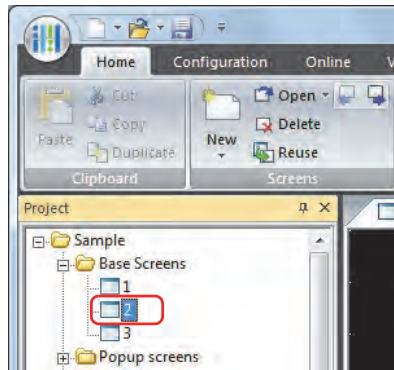

If you right click a screen in the **Project** window and then click **Open Screens**, the Open Screens dialog box is displayed.

● Opening specific screens

You can open multiple screens as a group.

- 1 On the **Home** tab, in the **Screens** group, click the arrow to the right of **Open**.
- 2 Click the **Base Screen** or the **Popup Screen**.

The Open Screens dialog box is displayed.

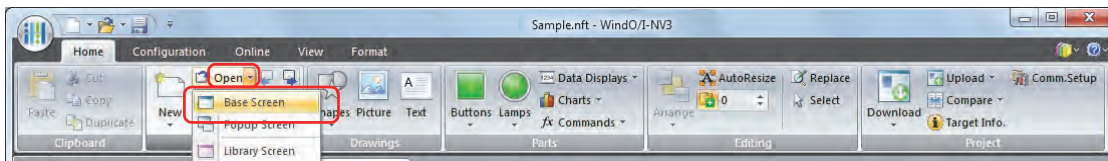

If you right click a screen folder in the **Project** window and then click **Open Screens**, the Open Screens dialog box is displayed.

- 3 Click the screens to open in **Screen List**, and then click **OK**.



To select multiple screens, press and hold SHIFT or CTRL while you click the specific items.

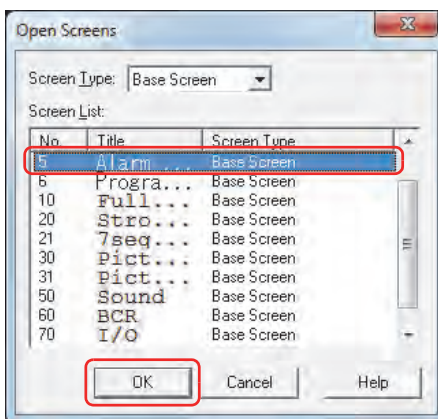

■ **Screen Type**

Select the type of screen to open from the following items. The selected screen type is displayed in **Screen List**.

All, Base Screen, Popup Screen

■ **Screen List**

This list shows screens that have already been created.

● Opening the previous or next screen

You can open the screen with the previous screen number or the next screen number of the screen displayed in the active editing window.

To open the screen with the previous screen number, click  (Open Previous Screen) in the **Screens** group on the

Home tab. To open the screen with the next screen number, click  (Open Next Screen).

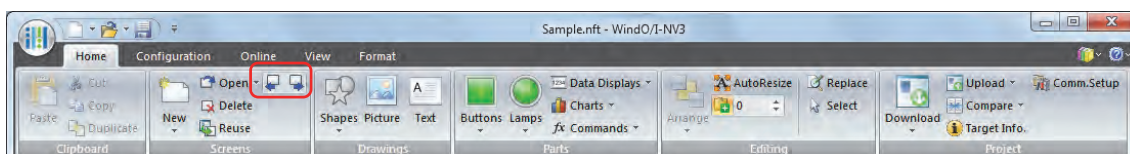

2.3 Saving Screens

● Saving a screen

You can save a single screen.

Right click the screen to save in the **Project** window, and then click **Save Screens**.

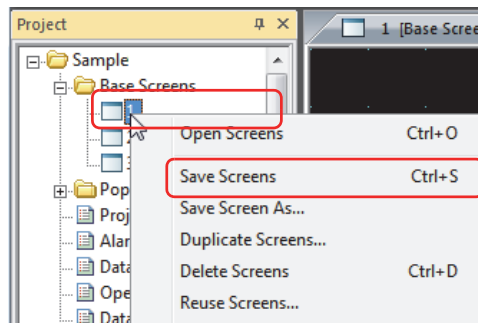

● Saving only specific screens

You can save multiple screens as a group.

- 1 Right click a screen folder in the **Project** window, and then click **Save Screens**.

The Save Screens dialog box is displayed.

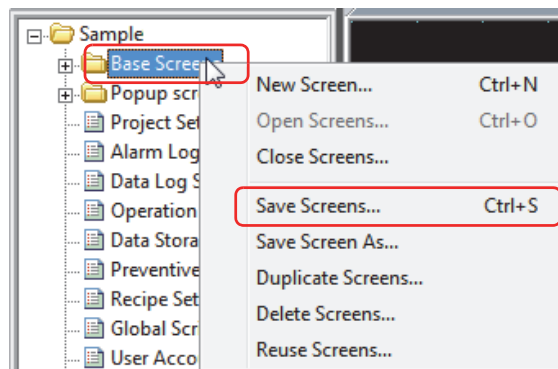

- 2 Click the screens to save in **Screen List**, and then click **OK**.



To select multiple screens, press and hold SHIFT or CTRL while you click the specific items.

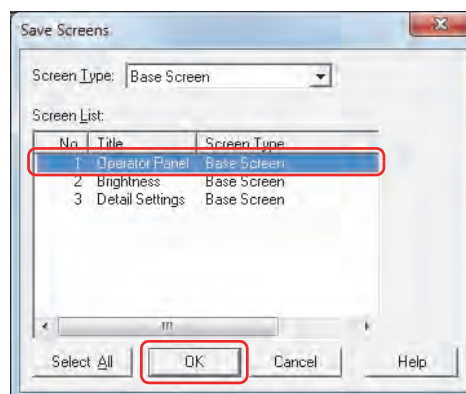

■ Screen Type

Select the type of screen to save from the following items. The selected screen type is displayed in **Screen List**.

All, Base Screen, Popup Screen

■ Screen List

This list shows the screens being edited.

■ Select All

Selects all the screens displayed in **Screen List**.

● Saving a screen with a different screen number

You can save the screen being edited with a different screen number.

1 Right click a screen in the **Project** window, and then click **Save Screen As**.

The Save Screen As dialog box is displayed.

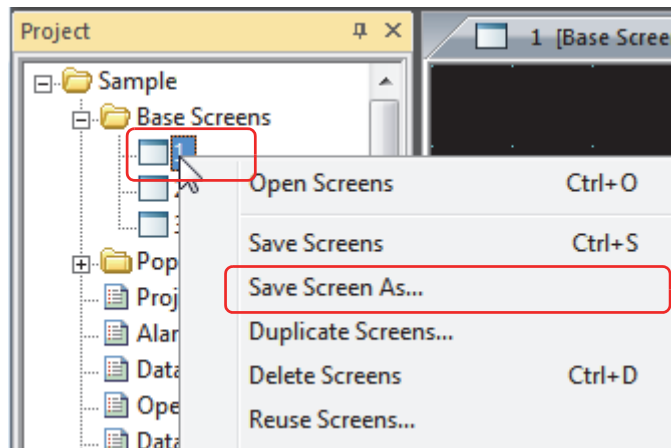

2 Specify the screen number after saving, and then click **OK**.

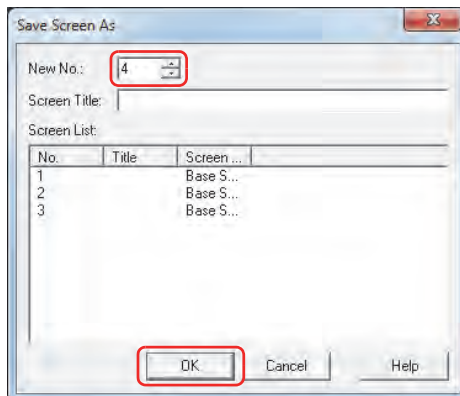

■ New No.

Specify the screen number (Base Screen: 1 to 3000, Popup Screen: 1 to 3015) after saving.

■ Screen Title

Enter or change the screen title. The maximum number is 40 characters.

■ Screen List

This list shows screens that have already been created.



If you specify an existing screen number and then click **OK**, an overwrite confirmation message is displayed.

- Click **Yes** to overwrite the screen.
- Click **No** to stop saving the screen.

2.4 Closing Screens

- Closing the displayed screen

You can close the active editing window.

Click  in the upper-right of the editing window.

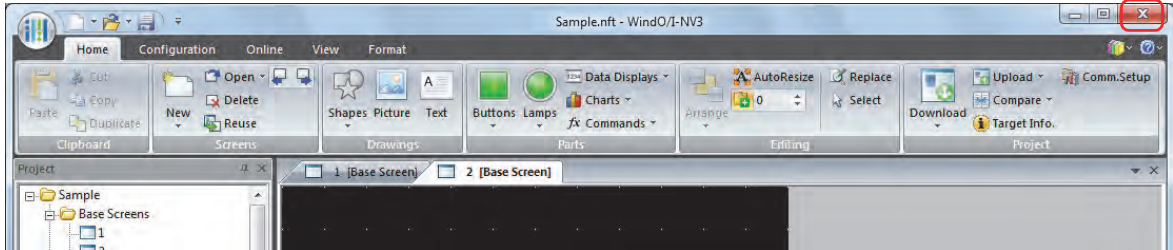

- Closing all screens

You can close all the editing windows.

On the **View** tab, in the **Window** group, click **Close All**.

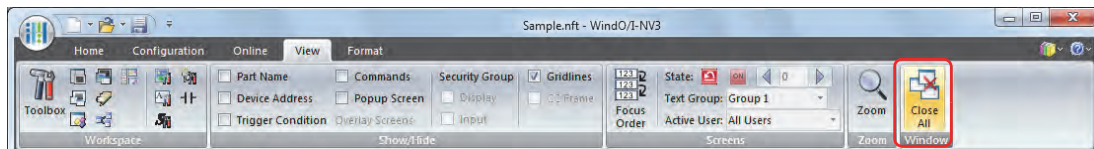

- Closing a specific screen
You can close multiple editing windows as a group.

- 1 Right click a screen folder in the **Project** window, and then click **Close Screens**.
The Close Screens dialog box is displayed.

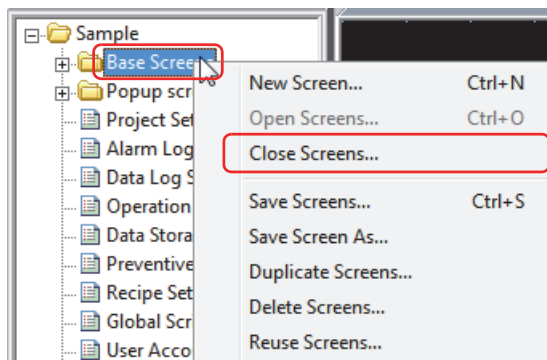

- 2 Click the screens to close in **Screen List**, and then click **OK**.



To select multiple screens, press and hold SHIFT or CTRL while you click the specific items.

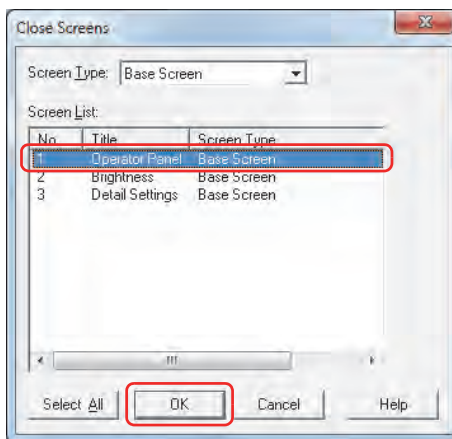

■ **Screen Type**

Select the type of screen to close from the following items. The selected screen type is displayed in **Screen List**.
All, Base Screen, Popup Screen

■ **Screen List**

This list shows the screens being edited.

■ **Select All**

Selects all the screens displayed in **Screen List**.



If you specify an unsaved screen and then click **OK**, a save confirmation message is displayed.

- Click **Yes** to save the screen and close it.
- Click **No** to close the screen without saving the changes.
- Click **Cancel** to stop saving the screen.

2.5 Duplicating Screens

You can copy a screen that has already been created to create a new screen.

- 1 Right click a screen folder or screen in the **Project** window, and then click **Duplicate Screens**.

The Duplicate Screens dialog box is displayed.

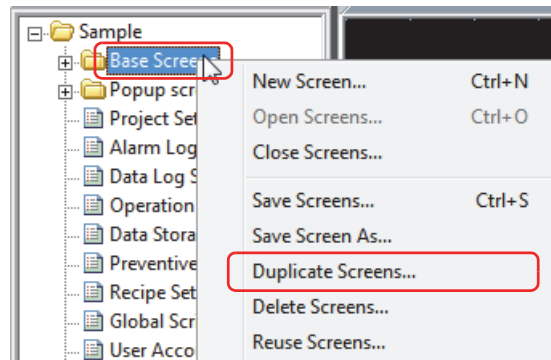

- 2 Select the screens to copy in **Screen List**.



To select multiple screens, press and hold SHIFT or CTRL while you click the specific items.

- 3 Specify **Screen No.** for the new screen and the **Number of copies** to duplicate, and then click **OK**.

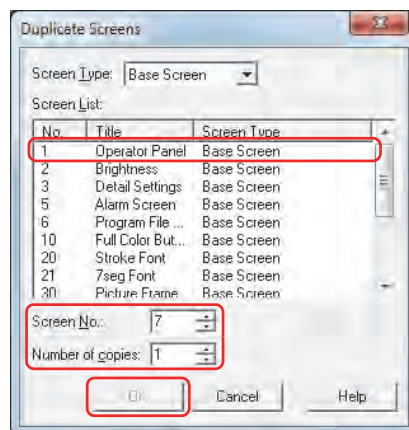

■ Screen Type

Select the type of screen to duplicate from the following items. The selected screen type is displayed in **Screen List**.

All, Base Screen, Popup Screen

■ Screen List

This list shows screens that have already been created.

■ Screen No.

Specify the screen number (Base Screen: 1 to 3000, Popup Screen: 1 to 3015) for the new screen.

■ Number of copies

Specify the number of screens to copy (Base Screen: 1 to 2999, Popup Screen: 1 to 3014).



- If multiple screens are selected in **Screen List** or if the **Number of copies** is 2 or more, consecutive screen numbers are added to the screens starting with the number specified in **Screen No.**
 Example: When a screen with screen number of **1** is selected in **Screen List**, the **Number of copies** is **3**, and **Screen No.** is **100** is selected, then the screen numbers after duplication are "100", "101", "102".

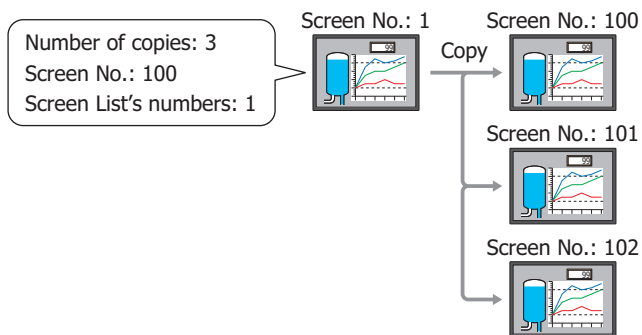

- Example: When screens with screen numbers **3** and **5** are selected in **Screen List**, the **Number of copies** is **2**, and **Screen No.** is **100** is selected, then the screen numbers after duplication are "100" and "102" for the screens duplicated from screen number **3** and "101" and "103" for the screens duplicated from screen number **5**.

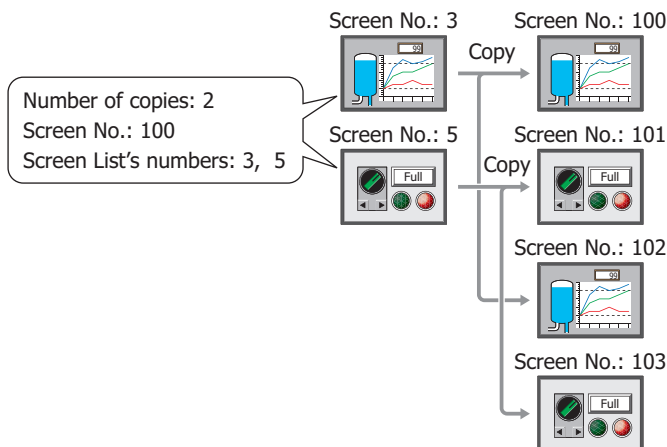

- If a screen number already exists after copying and you click **OK** on the Duplicate Screens dialog box, an overwrite confirmation message is displayed.
 - Click **Yes** to overwrite the screen with the number displayed in the confirmation message.
 - Click **Yes To All** to overwrite all the screens.
 - Click **No** to display the next confirmation message without copying the screen with the number displayed in the confirmation message.
 - Click **Cancel** to stop copying screens.

2.6 Deleting Screens

- Deleting a screen

You can delete a single screen.

- 1 Right click the screen to delete in the **Project** window, and then click **Delete Screens**.

A delete confirmation message is displayed.

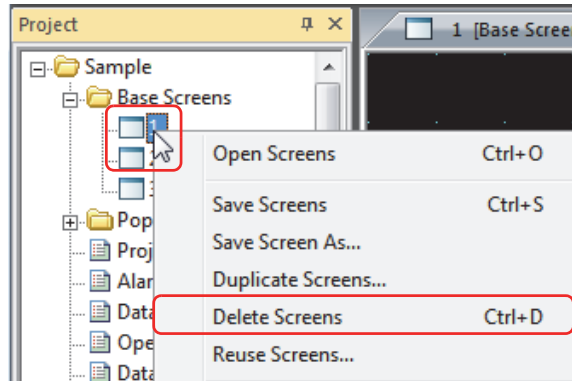

- 2 Click **Yes**.

The screen is deleted.

Click **No** or **Cancel** to stop deleting the screen.

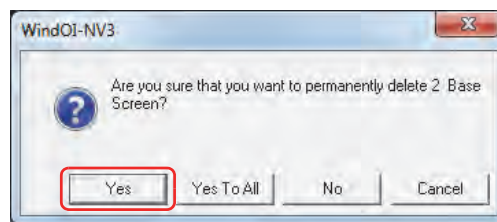

- Deleting specific screens

You can delete multiple screens as a group.

- 1 On the **Home** tab, in the **Screens** group, click **Delete**.

The Delete Screens dialog box is displayed.

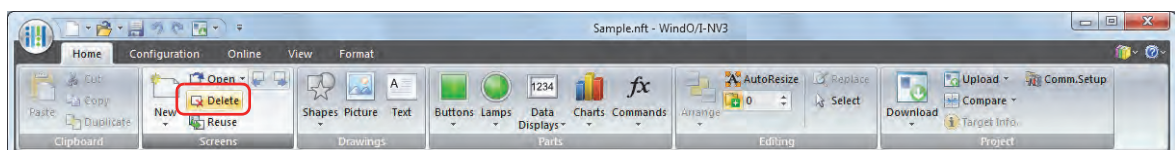

If you right click a screen folder in the **Project** window and then click **Delete Screens**, the Delete Screens dialog box is displayed.

- Click the screens to delete in **Screen List**, and then click **OK**.

A delete confirmation message is displayed.



To select multiple screens, press and hold SHIFT or CTRL while you click the specific items.

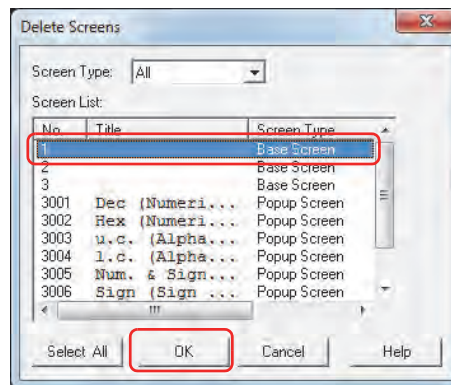

■ Screen Type

Select the type of screen to delete from the following items. The selected screen type is displayed in **Screen List**.

All, Base Screen, Popup Screen

■ Screen List

This list shows screens that have already been created.

■ Select All

Selects all the screens displayed in **Screen List**.

- Click **Yes** or **Yes To All**.

- Click **Yes** to delete the screen with the number displayed in the confirmation message. When deleting multiple screens, the next message to confirm deleting a screen is displayed.
- Click **Yes To All** to delete all the screens without displaying the confirmation message.
- Click **No** to display the next message to confirm deleting a screen without deleting the screen with the number displayed in the confirmation message.
- Click **Cancel** to stop deleting screens.

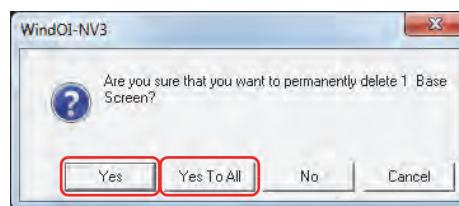

2.7 Reusing Screens

You can copy screens from other project data.

- 1 On the **Home** tab, in the **Screens** group, click **Reuse**.

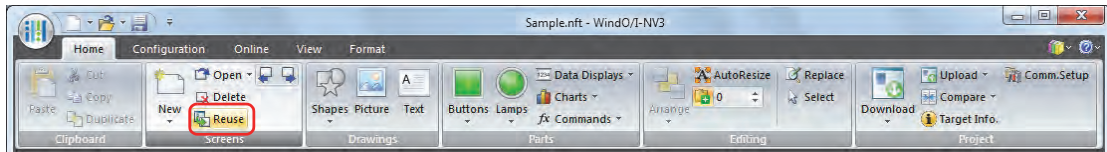

If you right click a screen folder or screen in the **Project** window and then click **Reuse Screens**, the Open dialog box is displayed.

- 2 Select project data that includes the screens to copy, and then click **OK**.

The Open Screens dialog box is displayed.

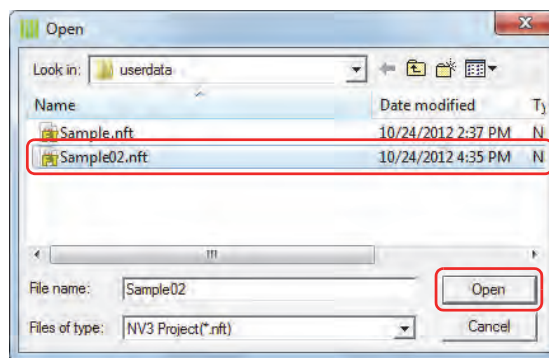

If a password has been configured for the project data, the Password Screen will be displayed. Select user name and enter password.

For details, refer to Chapter 21 “User Accounts and the Security Function” on page 21-1.

- 3 Click the screens to copy in **Screen List**, and then click **OK**.



To select multiple screens, press and hold SHIFT or CTRL while you click the specific items.

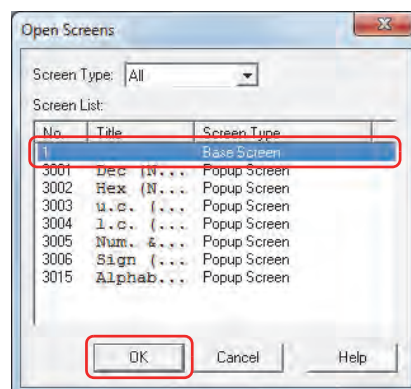

■ Screen Type

Select the type of screen to copy from the following items. The selected screen type is displayed in **Screen List**.

All, Base Screen, Popup Screen

■ Screen List

This list shows screens included in the source project data.



If the screen number of the screen to copy, a picture included in the screen, a text ID, or a script ID already exists in the project data being edited, an overwrite message is displayed.

- Click **Yes** to overwrite the item displayed in the confirmation message. If there are multiple redundant items, a confirmation message is displayed for each of those items.
- Click **Yes To All** to overwrite all of the picture numbers, pictures, text IDs, and script IDs.
- Click **No** to display a dialog box for each setting. Change the item to a unique screen number or ID number, and then click **OK**.
- Click **Cancel** to stop overwriting the displayed in the confirmation message. If there are multiple redundant items, a confirmation message is displayed for each of those items.

3 Base Screen

The screen that is displayed when the Touch is in Run Mode. This screen places drawing objects and parts on the base and creates a screen that is displayed on the Touch.

3.1 Base Screen Settings

● General Tab

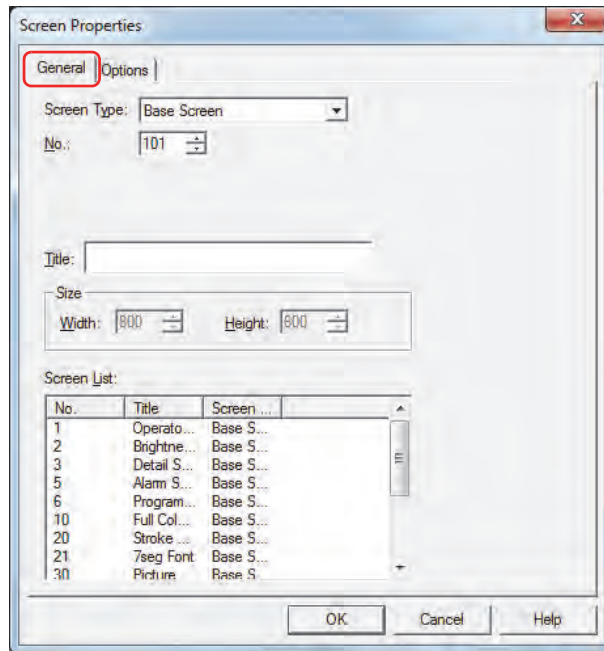

■ Screen Type

Select **Base Screen** as the screen type.

You can only select the screen type when creating a new screen.

■ No.

Enter the Base Screen's screen number (1 to 3000).

■ Title

Enter the Base Screen's title. The maximum number is 40 characters.

■ Size

Shows the screen size. You cannot change the size of Base Screens.

■ Screen List

This list shows screens that have already been created. It is only displayed when creating a new screen.

● Options Tab

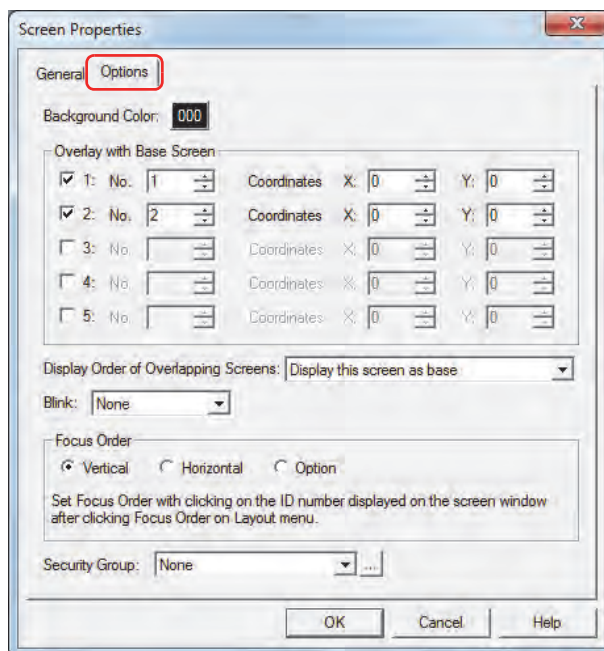

■ Background Color

Select the screen's background color (color: 256 colors, monochrome: 8 shades). Click this button to open the color palette. Select color with the color palette.



When **Overlay with Base Screen** is configured, the background color for the Base Screen specified as the background is displayed.

■ Backlight color *1

Select the backlight color for the screen from the following options.

"White", "Red", "Pink"

■ Overlay with Base Screen

Configure this section to display the Base Screen by overlaying screens.

- 1 to 5: Select these to display the Base Screen by overlaying screens.
- No.: Enter the overlay screen's screen number (1 to 3000).
- Coordinates X, Y: Specify the display location of the overlay screen in coordinates. The coordinates can be set in the range (Screen size - 1 dot).
The origin is the upper-left corner of the screen and the X- and Y-coordinates correspond to the upper-left corner of the overlay window.

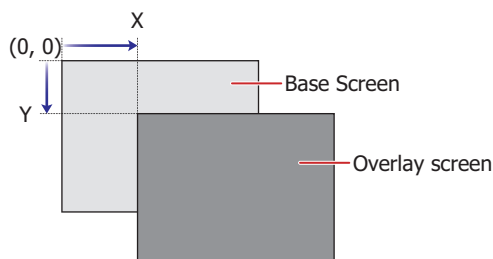

*1 Monochrome LCD models only

Display the Order of Overlapping Screens

You can select the display order of the Base Screen and the overlay screens.

Example: To display the Base Screen being edited as the background

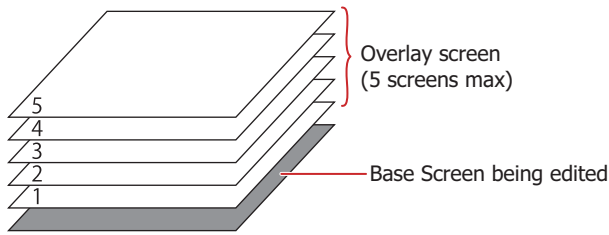

Example: To display the Base Screen being edited above overlay screen: 3

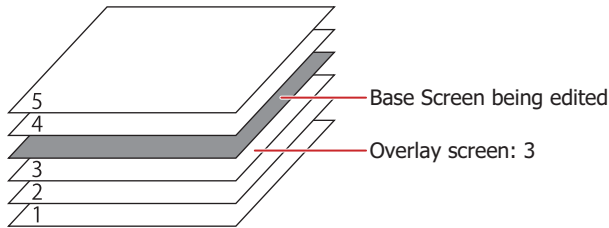

Blink

Select one of the following items as the setting when the screen is blinking.

- None: Displays the screen.
- Blink (1 sec cycle): The screen display is blinked in one second intervals.
- Blink (0.5 sec cycle): The screen display is blinked in half second intervals.
- Backlight OFF: Turns off the backlight until the screen is touched or until System Area 1 (address+1, bit 0 or bit 7) is set to 1.

Focus Order

Sets the focus order for Numerical Input and Character Input. The focus order is the order the focus moves between Numerical Input or Character Input when the user presses the **ENT** key. Text can be input in Numerical Input or Character Input that has focus. The focus order number starts from 0.

- Vertical: The focus moves vertically from top to bottom.
- Horizontal: The focus moves horizontally from left to right.
- Custom: Sets the desired order for moving the focus.
On the **View** tab, in the **Screens** group, click **Focus Order**, and then click the parts in the order to move the focus.



The focus moves in the following order when Numerical Input and Character Input on the screen is not aligned to the left or top.

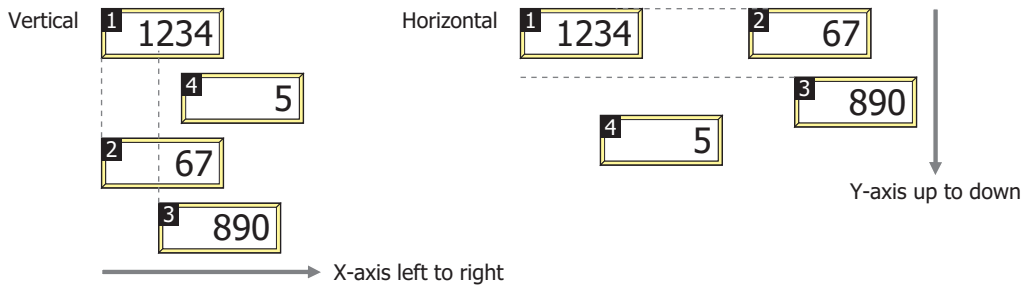

■ Security Group

Select the security group to restrict the screen display.

This option can only be set when **Use Security functions** is selected. The **Use Security functions** check box is set on **General** tab in the User Accounts dialog box.

None: Any user can open this screen.

Administrator, Operator,

Reader, (Created security group): Only a selected user can open this screen.

Click  to display the Security Group Settings dialog box. If you create a security group in the Security Group Settings dialog box, you can select that created group. For details, refer to Chapter 21 "2.2 Adding and Editing Security Groups" on page 21-15.



For details about the security function, refer to Chapter 21 "User Accounts and the Security Function" on page 21-1.

3.2 Displaying Layered Base Screens

It is possible to layer and display multiple Base Screens. The coordinates and display order for layered screens can be set on the screen that will serve as the base. The maximum number of layered screens is five screens.

■ Coordinates

Using the upper-left corner of the screen as the origin, the upper-left area of the layered screen become the X and Y coordinates.

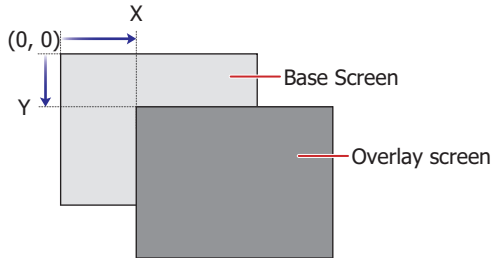

■ Display Order

This allows you to select the order of display for the screen that will serve as the base and layered screens.

Example: Displaying a Base Screen that is currently being edited as the bottom most layer

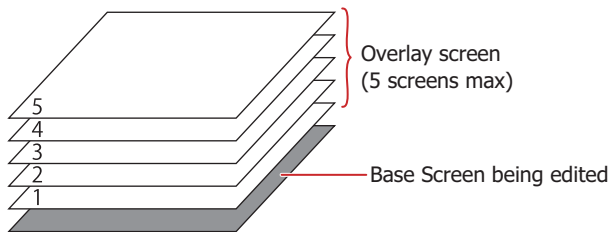

Example: Displaying a Base Screen currently being edited on the layered screen: 3.

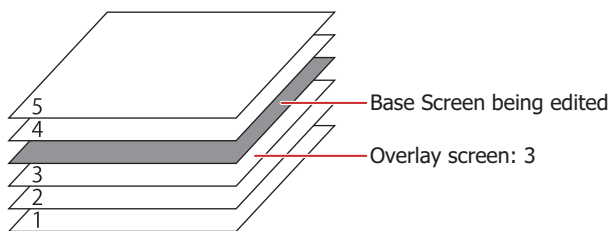

For details about how to configure these settings, refer to “3.1 Base Screen Settings” on page 4-14.

Example: When Base Screen: 100 which has a clock placed in it is used as a layered screen, Base Screen:1 which is displayed as the base and Base Screen: 2 will be displayed as follows:

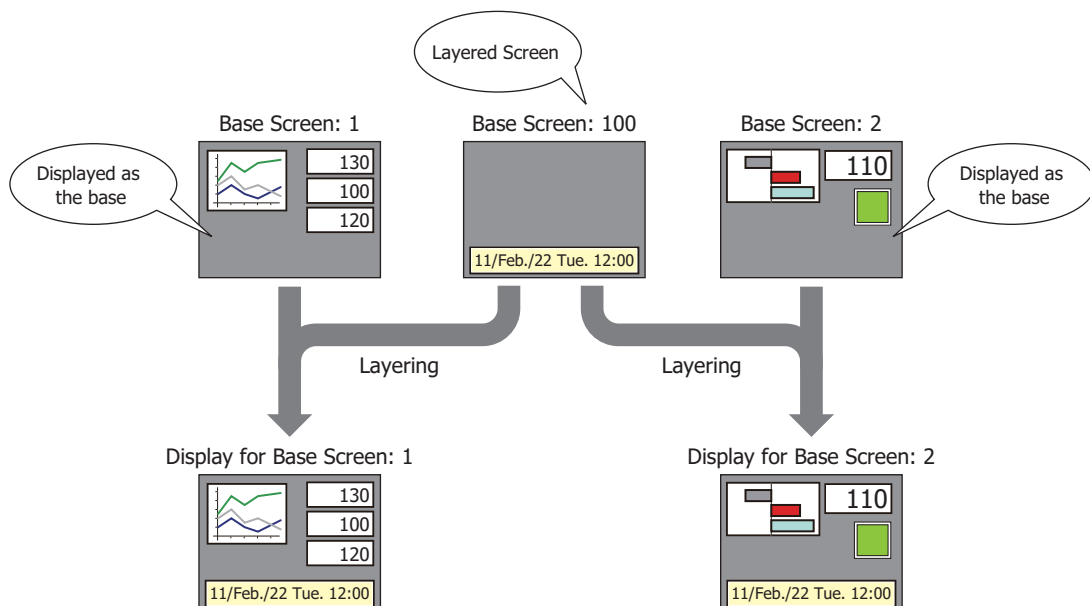



- Layered screens that have been set as layered screens will not be displayed on the screen that is displayed as the base.

Example: Layering and displaying Base Screen: 100 on Base Screen: 1
 Layering and displaying Base Screen: 101 on Base Screen: 100

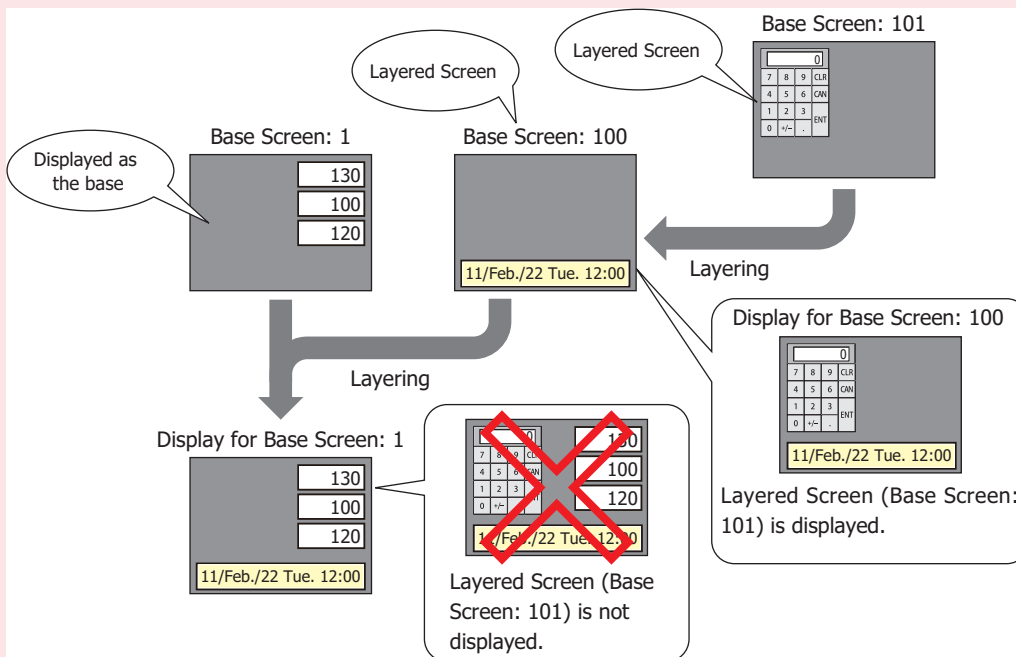

- Drawing objects and parts from layered screens may not display properly when placed outside of the displayed area.

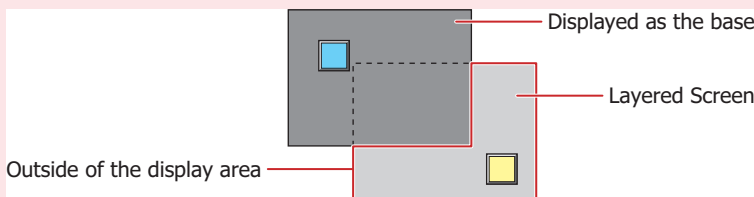

3.3 Operating When Drawing Objects and Parts Overlap

Place drawing objects and parts or parts with other parts so that they do not overlap. When drawing objects and parts are placed or the screens are layered, if the drawing objects and parts have overlapped, the following behaviors will occur.

● When Drawing Objects and Parts Overlap

The parts will always be displayed on the foremost layer.

Example: A case where Base Screen: 2 is layered with base: 1 as the bottom most layer, and the Numerical Display belonging to Base Screen: 1 and a drawing object belonging to Base Screen: 2 overlap.

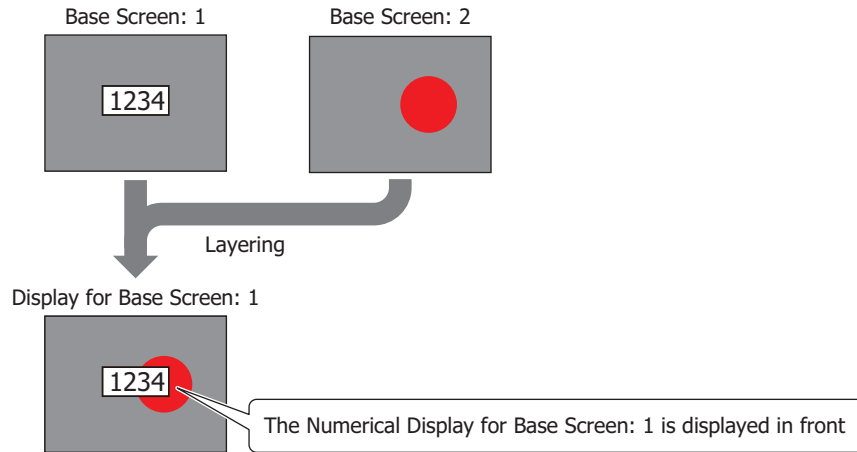

● When Parts Overlap

The following behaviors will occur when data or updated parts are displayed in front.

Example: Base Screen: 2 is layered with base: 1 as the bottom most layer, and the Numerical Display belonging to Base Screen: 1 and Numerical Display belonging to Base Screen: 2 overlap.

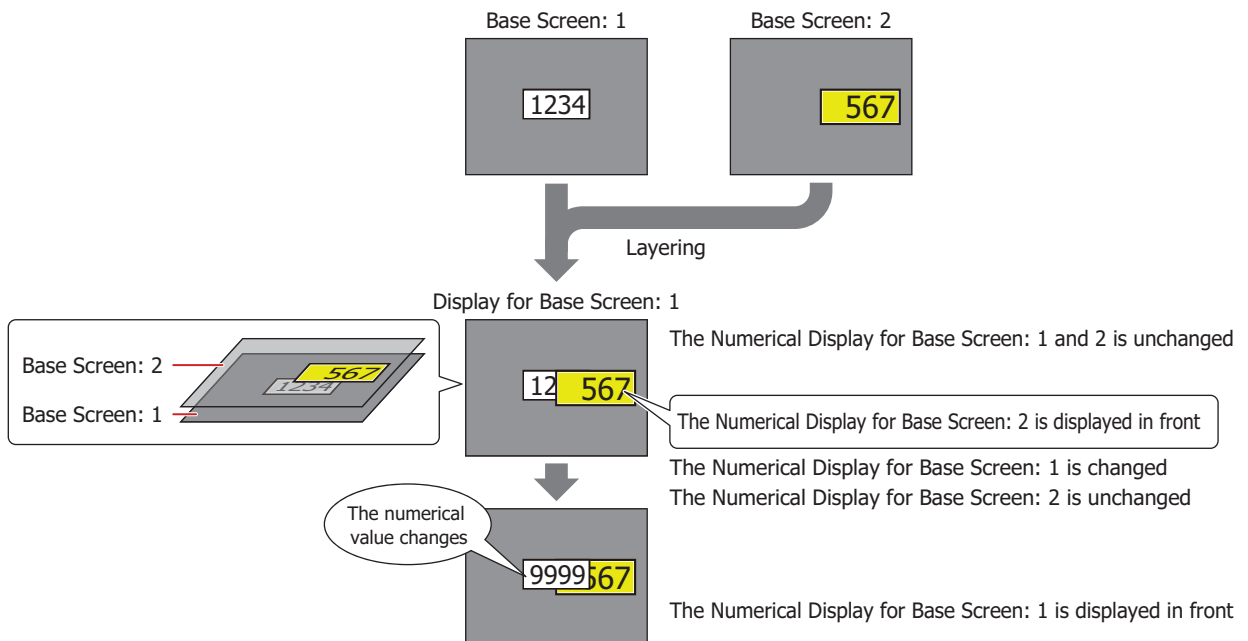

 For the Message Display, Message Switching Display, and Alarm List Display, when the **Scroll** check box is selected on the **Format** tab, the display is not correctly displayed when a part overlaps it.

- When touch switches have overlapped

Pressing the touch switch activates the touch switch of the bottom most Base Screen and displays it in front.

Example: A case where Base Screen: 2 is layered with base: 1 as the bottom most layer (Touch switch two-point push: disabled)

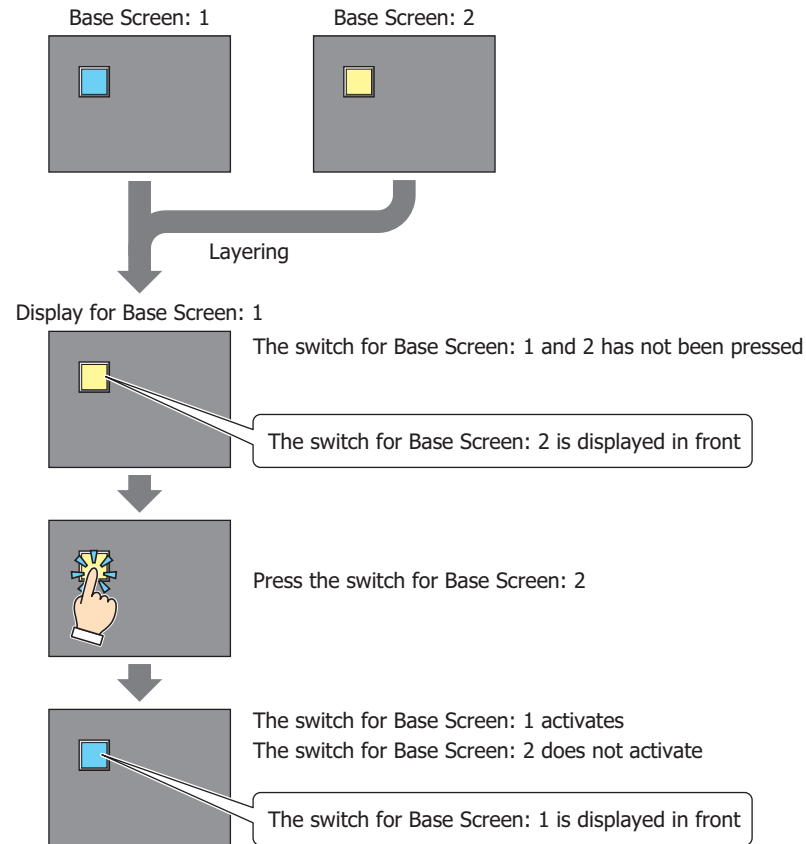

When touch switch two-point push is enabled, the touch switches will be activated and the display will be updated in order starting from the switch located one layer above the bottom-most switch. Touch switch two-point push is selecting the check box labeled **Enable Two-point Push** under the **System** tab in the Project Settings dialog box.



The touch switch two-point push is a function performed on the analog touch panel that activates both switches when two overlapped touch switches have been pressed. There is no function that activates both switches simultaneously when two switches have been pressed.

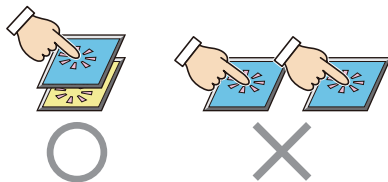

4 Popup Screen

The Popup Screen that is displayed on the Base Screen when the Touch is in Run Mode. The size and coordinates of the screen can be specified and this screen can also be moved on the Base Screen.

4.1 Popup Screen Settings

● General Tab

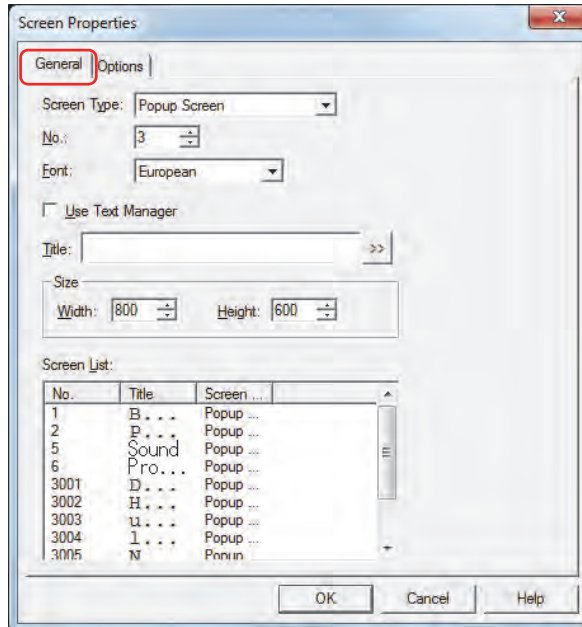

■ Screen Type

Select **Popup Screen** for the screen type.

You can only select the screen type when creating a new screen.

■ No.

Enter the Popup Screen's screen number (1 to 3015).

However, screen numbers 3001 to 3015 are Popup Screens for standard Keypads for Numerical Input and Character Input.

■ Font

Select the font to use for the title from the following choices:

Japanese, European, Chinese, Taiwanese, Korean, Central European, Baltic, Cyrillic

This option can only be selected when **Use Text Manager** is cleared.

■ Use Text Manager

Select this to use text registered in Text Manager for the screen title.

However, the text color is white, not the color set in Text Manager.

■ Text ID

Specify the Text Manager ID number (1 to 32000) to use text registered in Text Manager. Click  to display Text Manager.

This option can only be set when **Use Text Manager** is selected.

■ Title

Enter the Popup Screen's title. The maximum number is 40 characters. This title is displayed in the Popup Screen's title bar.

This option can only be entered when **Use Text Manager** is cleared.



To enter Unicode text, click  to display the Unicode Input dialog box. Enter the text in the Unicode Input dialog box, and then click **OK**.

■ Size

Width, Height: Specify the width (40 dots to Base Screen width) and the height (40 dots to Base Screen height) of the Popup Screen.

■ Screen List

This list shows screens that have already been created. It is only displayed when creating a new screen.

● Options Tab

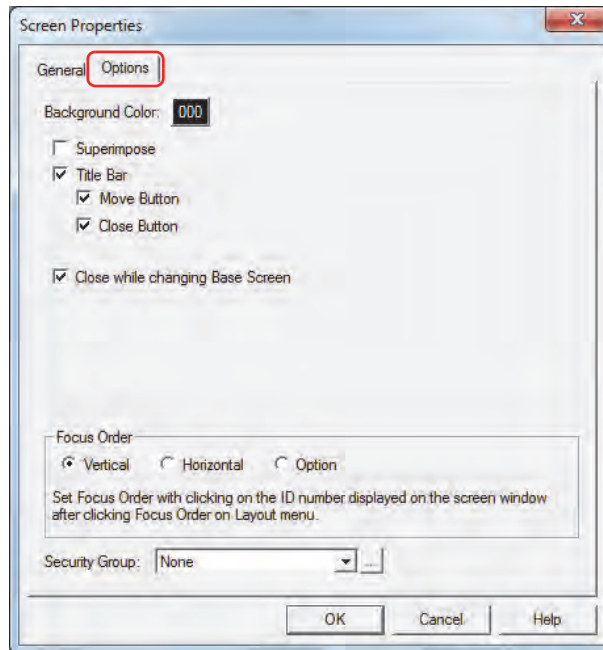

■ Background Color

Select the screen's background color (color: 256 colors, monochrome: 8 shades). Click this button to open the color palette. Select the color with the color palette.

■ Superimpose

Displays the Popup Screen's background as completely transparent. The screen underneath the popup screen can be seen.





If you select **Superimpose**, the buttons underneath the Popup Screen set to superimpose are active.

■ Title Bar

Select this to display the title bar on the Popup Screen. The text set in **Title** on the **General** tab is displayed in the title bar.

The title bar is not displayed if superimpose is set.

Move Button: Select this to display the  (Move) button on the title bar.

Close Button: Select this to display the  (Close) button on the title bar.

■ Close while changing Base Screen

Select this to close the displayed Popup Screen when changing the Base Screen.

■ Focus Order

Sets the focus order for Numerical Input and Character Input. The focus order is the order the focus moves between Numerical Input or Character Input when the user presses the **ENT** key. Text can be input in Numerical Input or Character Input that has focus. The focus order number starts from 0.

Vertical: The focus moves vertically from top to bottom.

Horizontal: The focus moves horizontally from left to right.

Custom: Sets the desired order for moving the focus.

On the **View** tab, in the **Screens** group, click **Focus Order**, and then click the parts in the order to move the focus.



The focus moves in the following order when Numerical Input and Character Input on the screen is not aligned to the left or top.

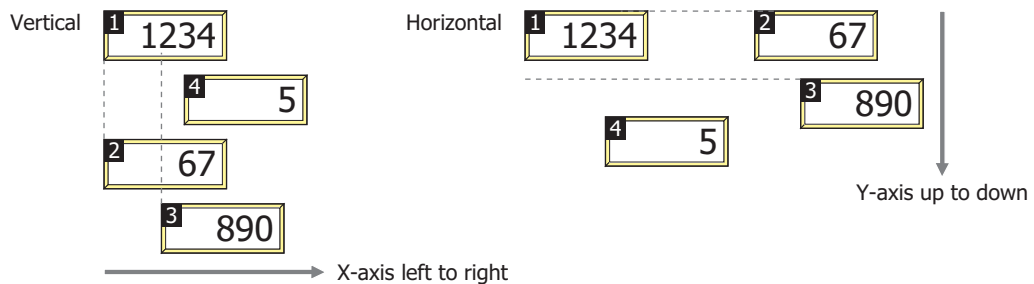

■ Security Group

Select a security group to restrict displaying the screen.

This option can only be set when **Use Security functions** is selected. The **Use Security functions** check box is set on **General** tab in the User Accounts dialog box.

None: Any user can open this screen.

Administrator, Operator,

Reader, (Created security group): Only selected users can open this screen.

Click  to display the Security Group Settings dialog box. If you create a security group on the Security Group Settings dialog box, you can select that created group. For details, refer to Chapter 21 "2.2 Adding and Editing Security Groups" on page 21-15.



For details about the security function, refer to Chapter 21 "User Accounts and the Security Function" on page 21-1.

4.2 Popup Screen Configuration

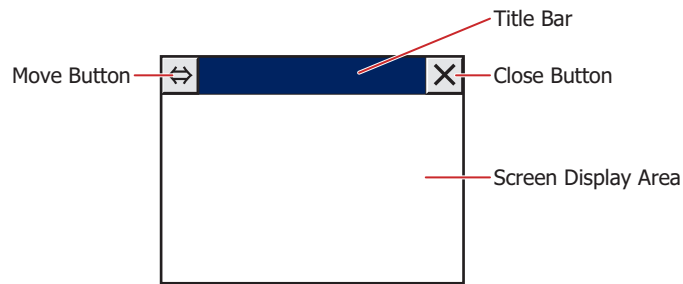

■ Title Bar

Displays buttons and the title of the Popup Screen.

Pressing the title bar of the screen allows you to move the screen to the front.

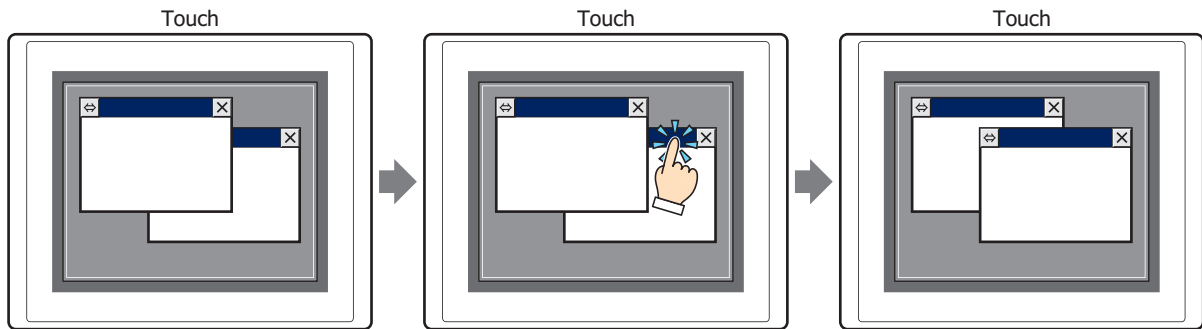

When there is a title bar on the Popup Screen, touch switches that are within 20 dots of the title bar will not respond.

■ (Move)

Moves the Popup Screen.

1 Press .

2 Press the position where the screen will be moved to.

3 The screen will move the position that was pressed.

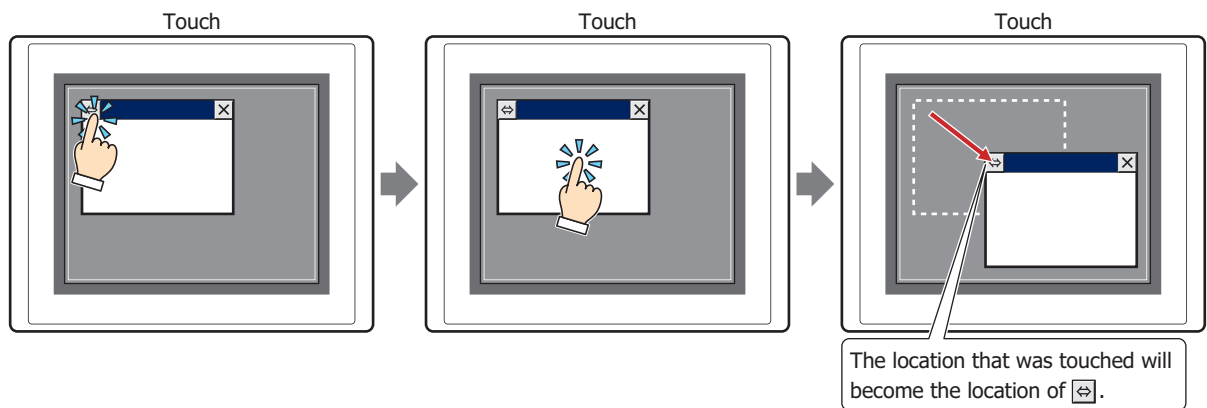

• The Popup Screen can be moved in the range where  can be displayed.

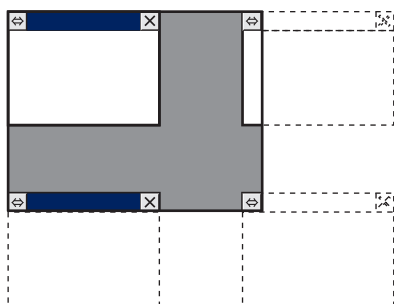

• The Popup Screen will be moved in units of 1 dot.

-  **(Close)**
Closes the Popup Screen.

- **Screen Display Area**
The area where drawing objects and parts are placed.

4.3 Standard Keypad Popup Screen

A Popup Screen that places a regular Keypad used for Numerical and Character Input on screen numbers 3001 to 3015 with the WindO/I-NV3.

Decimal (Number Value) Keypad

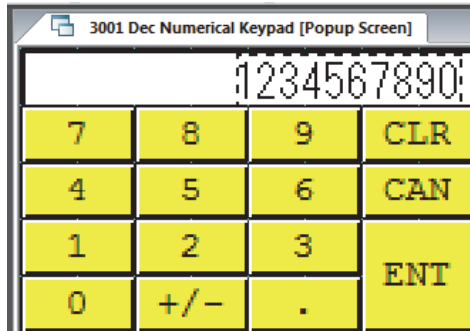

Uppercase (Alphabet) Keypad

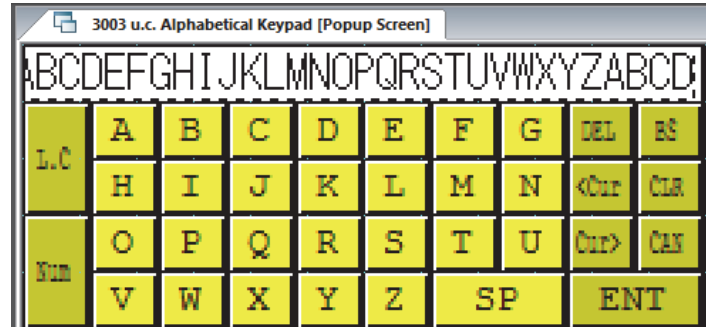

- The Standard Keypad Popup Screen can also place drawing objects and parts in the same manner as Popup Screen numbers 1 to 3000.
- Screen numbers 3001 to 3015 are screen numbers that are empty when a new project has been created and are handled as normal Popup Screens.
- Deleting a Standard Keypad Popup Screen and recreating a new Popup Screen of the same screen number will place the same Keypad.

5 Screen Restrictions

5.1 Screen Number Restrictions

The number of screens and layered screens that can be created in a single project and the number of Popup Screens that can be displayed on the Base Screen are as follows:

■ Base Screen

Item	Number of screens
Number of screens that can be created	3,000 max.
Number of layered screens	5 max.

■ Popup Screen

Item	Number of screens
Number of screens that can be created	3,015 max.
Number of screens that can be displayed on the Base Screen	3 max. (Including the Device Monitor and Ladder Monitor*1)

5.2 Maximum Number of Parts

■ Number of Parts That Can be Placed on a Single Screen

Screen	Number of Parts
Base Screen	960 max.
Popup Screen	480 max.

■ Number of Parts That Can be Displayed on a Single Screen

In addition to the currently displayed Base Screen, this includes layered screens and currently displayed Popup Screens.

Parts	Number of Parts
Alarm List Display, Alarm Log Display	Limit to 1. Either one but can't be both.
Numerical Inputs and Character Inputs in a constant state of input	Limit to 1. Either one but can't be both.
Potentiometer	32 max.
Numerical Input	255 max.
Character Input	255 max.

*1 The maintenance screen is not included.

5.3 Maximum Number of External Device Address

The number of write-destination devices for usable external device addresses and the number of read-source devices from the external device addresses differ depending on the screen type.

■ Base Screen (Includes Layered Screens)

External Device Address	Number of Devices
Write-destination Device	512 max.
Read-source Devices	256 max.

■ Popup Screen

External Device Address	Number of Devices
Write-destination Device	128 max.
Read-source Devices	64 max.



If the same device address is used in multiple device settings, the used number of devices will be counted as one device. It will not be counted as one point per device setting.

5.4 Vertical Installation Restrictions

Even if you choose for them to be installed and displayed vertically, the next screen will be the same as horizontal installation and display.

- System Mode
- Maintenance Screen
- Brightness/contrast adjustment screen ^{*1}, brightness adjustment screen ^{*2}
- Password Screen

*1 Monochrome LCD models only

*2 Color LCD models only

6 Using Library Screens

6.1 What You Can Do with Library Screens

A Library Screen is a screen where you can register frequently used drawing objects, parts, and operations in WindO/I-NV3. These screens can be accessed while editing project data. You can quickly create screens by using Library Screens.

To copy Library Screens to other computers and use them as common Library Screens, use the import and export functions.

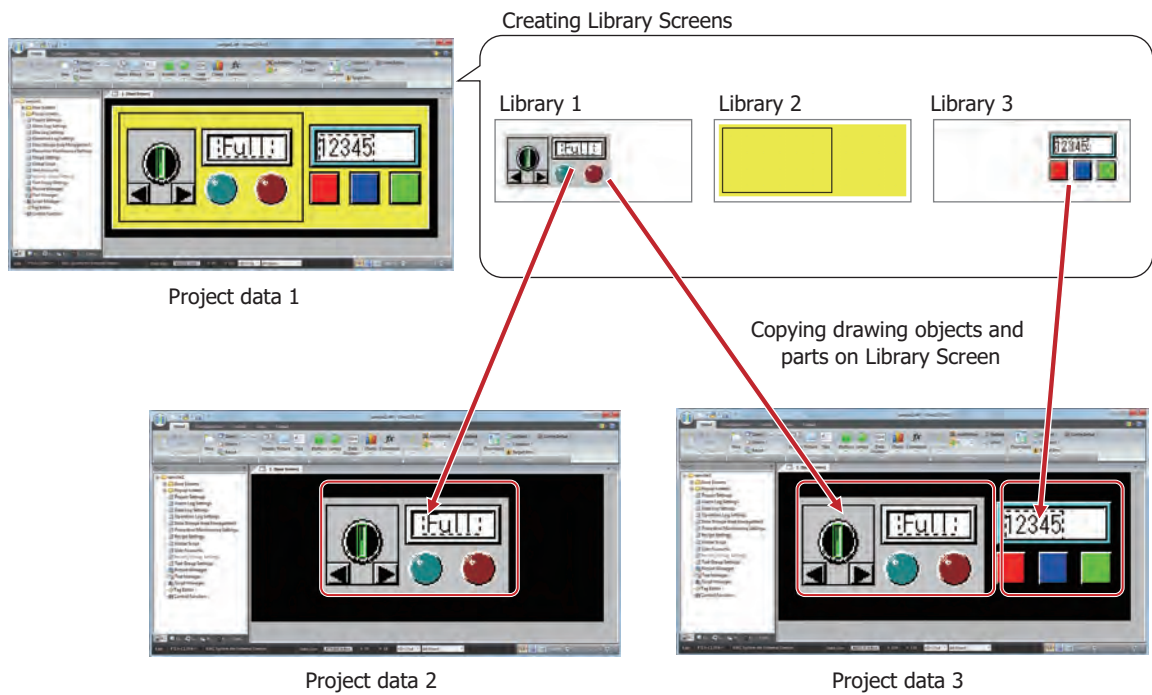

6.2 Creating a Library Screen

- 1 On the **Home** tab, in the **Screens** group, click ▼ under **New**.
- 2 Click the **Library Screen**.

The Create Library dialog box is displayed.

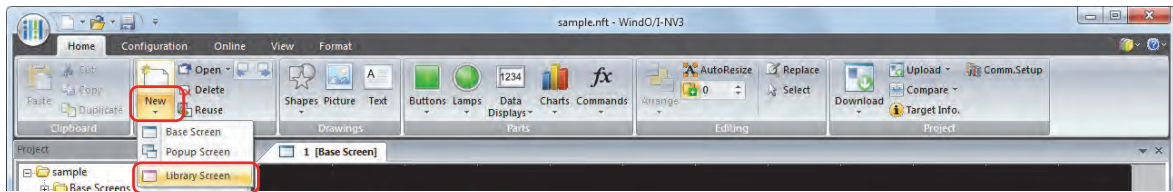

- 3 Enter a name in **New Library** and then click **OK**.
- The Library Screen is displayed.

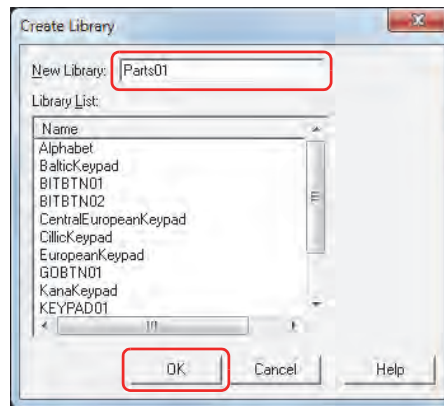

■ New Library

Enter the name for the Library Screen. Maximum number is 40 characters.



You cannot use the following characters in the library name.

. \ / : * ? " < > |

■ Library List

This list displays the registered Library Screens.

- 4 Configure parts and drawing objects in the Library Screen and create the screen.

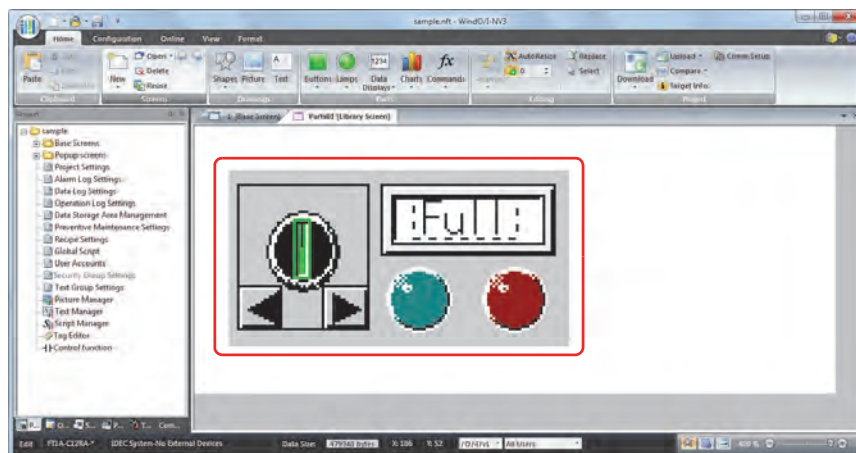

- 5 When you are finished creating the Library Screen, click  in the upper right of the screen.
A save confirmation message is displayed.
- 6 Click **Yes**.
This saves the Library Screen and then closes it.
Click **No** to close the Library Screen without saving it.
Click **Cancel** to return to the editing window without saving the Library Screen.

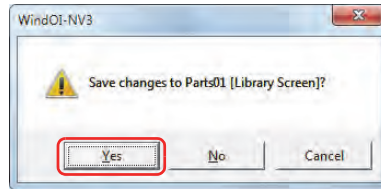

6.3 Using a Library Screen

Open a registered Library Screen to use for creating a Base Screen or Popup Screen.

- 1 On the **Home** tab, in the **Screens** group, click ▼ to the right of **Open**.
- 2 Click the **Library Screen**.
The Open Library dialog box is displayed.

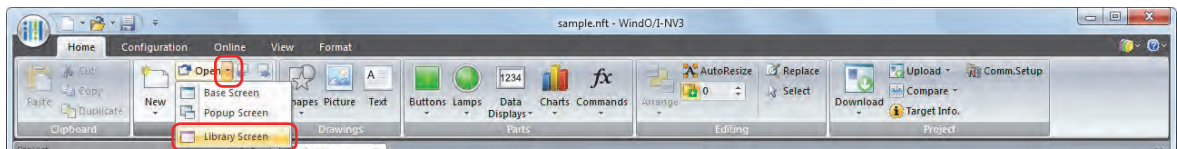

- 3 Select the Library Screen and then click **OK**.



To select multiple screens, **Shift** key + click the specific screens or **Ctrl** key + click the specific screens.

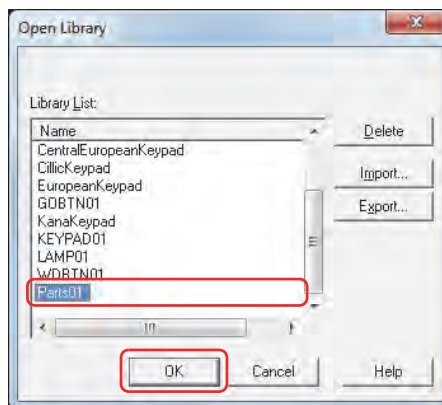

- **Library List**
This list displays registered Library Screens.
- **Delete**
Deletes the Library Screen selected in **Library List**.
- **Import**
Imports an exported Library Screen.
- **Export**
Exports the Library Screen selected in **Library List**.

- 4 Drag and drop or copy and paste objects to use from the Library Screen to the screen being edited.

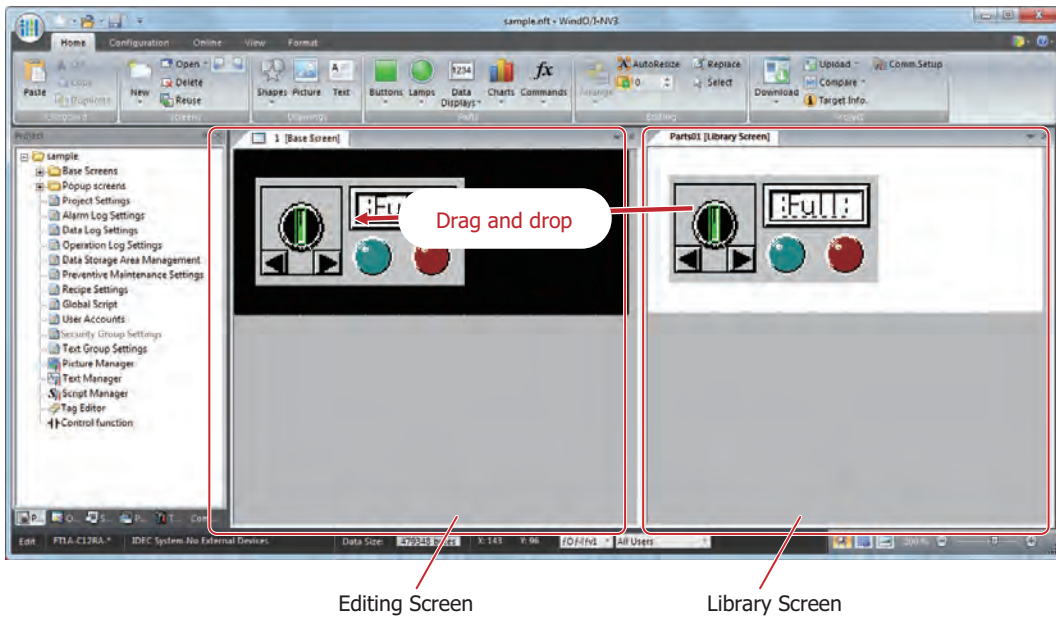

You can re-edit objects placed on the edited screen from the Library Screen.

6.4 Deleting Library Screens

You can delete multiple Library Screens as a group.

- 1 On the **Home** tab, in the **Screens** group, click ▼ to the right of **Open**.
- 2 Click the **Library Screen**.

The Open Library dialog box is displayed.

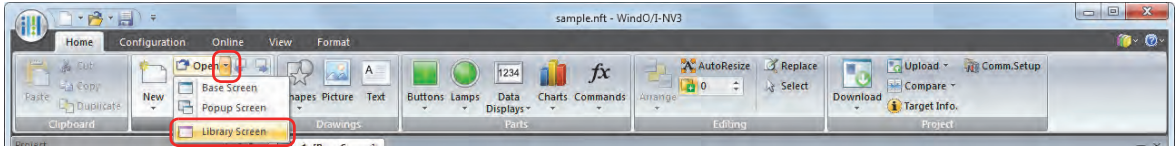

- 3 Select the Library Screen to delete in **Library List** and then click **Delete**.

A delete confirmation message is displayed.



To select multiple screens, **Shift** key + click the specific screens or **Ctrl** key + click the specific screens.

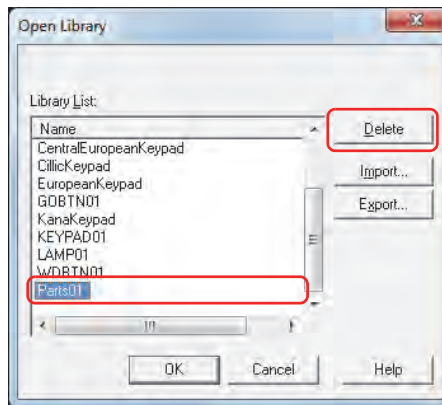

- 4 Click **Yes** or **Yes To All**.

- Click **Yes** to delete the Library Screen with the library name displayed in the confirmation message. When deleting multiple Library Screens, the next message to confirm deleting a Library Screen is displayed.
- Click **Yes to All** to delete all the Library Screens without displaying the confirmation message.
- Click **No** to display the next message to confirm deleting a Library Screen without deleting the Library Screen with the library name displayed in the confirmation message. You will return to the editing window when finished confirming all the Library Screens.
- Click **Cancel** to stop deleting Library Screens and return to the editing window.

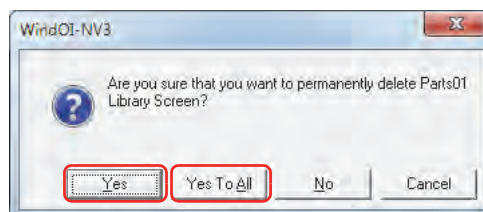

6.5 Exporting Library Screens

To use created Library Screens on another computer, export those Library Screens.

- 1 On the **Home** tab, in the **Screens** group, click ▼ to the right of **Open**.
- 2 Click the **Library Screen**.

The Open Library dialog box is displayed.

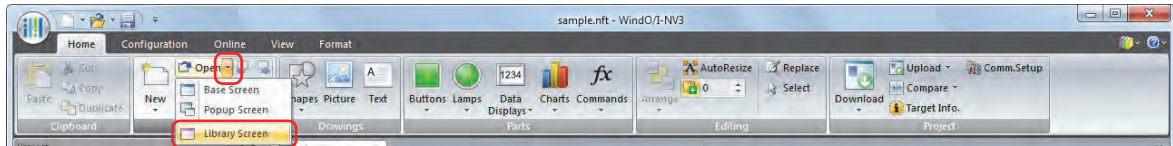

- 3 Select the Library Screens to export in **Library List** and then click **Export**.
- The Save As dialog box is displayed.



To select multiple screens, Shift key + click the specific screens or Ctrl key + click the specific screens.

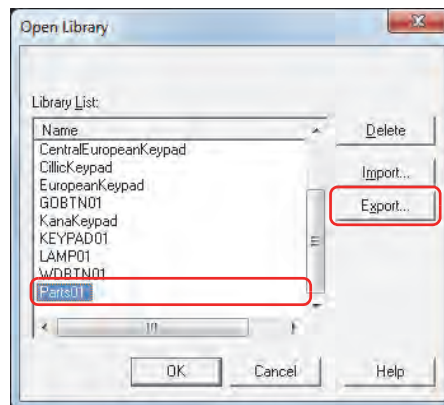

- 4 Specify **Save in** and click **Save**.

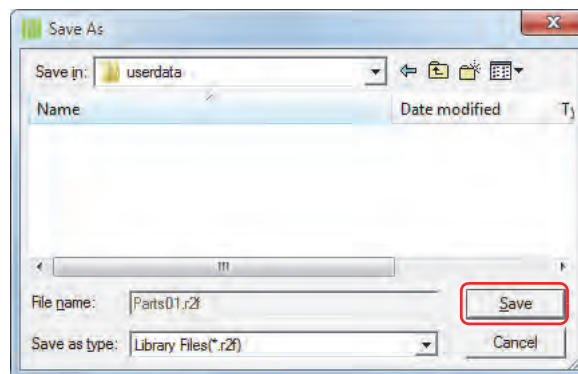

6.6 Importing Library Screens

To use Library Screens created on another computer, import those exported Library Screens into WindO/I-NV3.

- 1 On the **Home** tab, in the **Screens** group, click ▼ to the right of **Open**.
- 2 Click the **Library Screen**.

The Open Library dialog box is displayed.

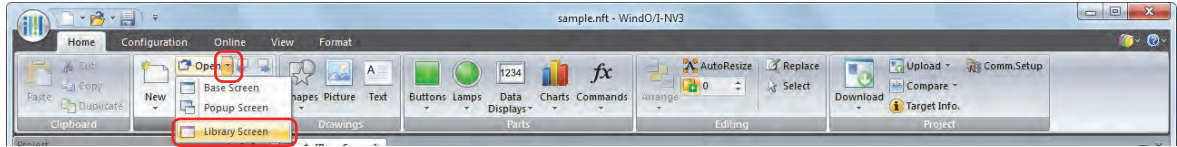

- 3 Click **Import**.

The Open dialog box is displayed.

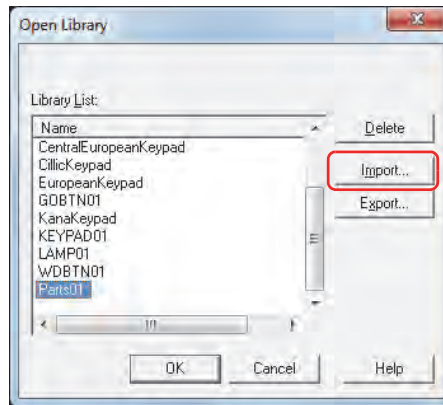

- 4 Select a Library Screen file (*.r2f) and click **Open**.

The imported Library Screen is displayed in **Library List**.

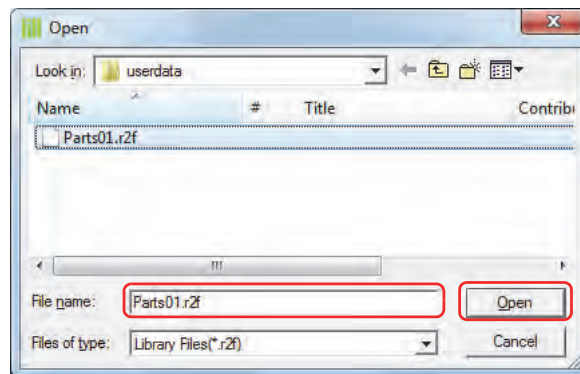

Chapter 5 Drawings and Parts

This chapter contains an overview of drawings and parts that are used when creating a screen and a description of the types of drawings and parts.

1 Overview

Drawings and parts are used by placing them on Base Screens and Popup Screens.

Drawings include objects such as straight lines, polygons, circles, pictures, and static text.

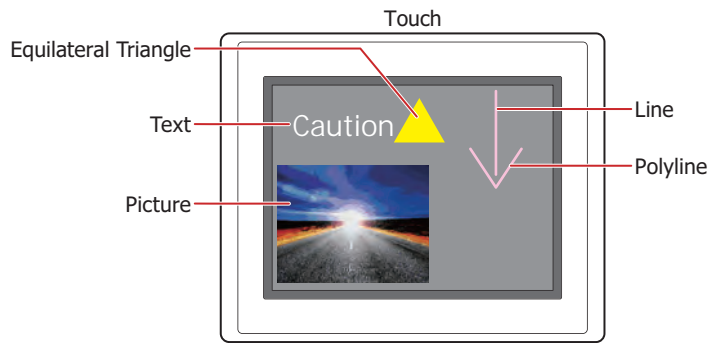

Parts are objects that generate a variety of events when triggered by a change in the values of devices or by touch.

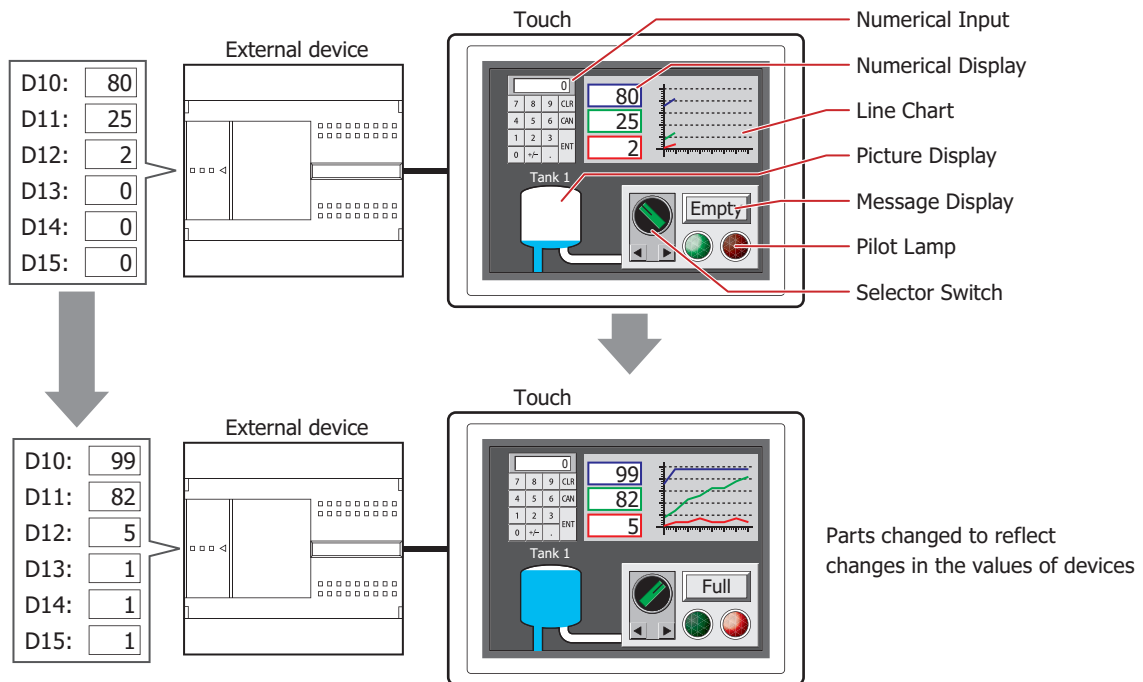

2 Drawing Objects

This section describes the drawing objects that can be drawn in WindO/I-NV3.

2.1 Shapes

Shapes		Function
Basic Shapes	Line	Draws a line.
	Polyline	Draws a polyline.
	Polygon	Draws an object that connects two or more vertices with straight lines.
	Rectangle	Draws a rectangle.
	Circle/Ellipse	Draws a circle or ellipse.
	Arc	Draws an elliptical arc.
	Pie	Draws a pie.
Equilateral Polygon		Draws a equilateral polygon. (triangle, diamond, pentagon, hexagon, or octagon)
Paint		Paints the closed region of the drawing object.

2.2 Picture

Loads drawing objects that are registered in Picture Manager onto the edit screen.

2.3 Text

Draws text. The maximum number is 3,750 characters.

Loads text that is registered in Text Manager.

3 Part Types

This section describes the parts that can be used on the Touch.

3.1 Buttons

Part	Description
Bit Button	Writes a 0 or 1 to a bit device.
Word Button	Writes a value to a word device. Can be used to indirectly specify the destination address or to perform operations on the written value.
Goto Screen Button	Switches to another screen or displays a window.
Key Button	Performs a variety of functions including uploading and downloading, copying files, and operating other parts.
Multi-Button	Executes multiple commands at once.
Keypad	A part comprised of Key Buttons. Enters numbers and characters into numerical or character input parts.
Selector Switch	Writes a 0 or 1 to a bit device. This is an exclusive control that only writes a single value as 1 and all other values as 0.
Potentiometer	Writes a value selected by pressing a slider button to a word device.

3.2 Lamps

Part	Description
Pilot Lamp	Displays images. Switches the displayed image according to the value of a bit device.
Multi-State Lamp	Displays images. Switches the displayed image according to the value of a word device.

3.3 Data Displays

Part	Description
Numerical Input	Uses either a Keypad or Key Button to write entered numbers.
Character Input	Uses either a Keypad or Key Button to write the character code for entered characters.
Picture Display	Displays images. Switches, moves or enlarges/reduces the displayed image according to the value of a word device, the bit status within a word device or at a fixed period.
Message Display	Loads fixed text strings and values of word device as character codes and displays them on the screen.
Message Switching Display	Switches the displayed fixed text string according to the value of a word device or the bit status within a word device.
Alarm List Display	Switches the displayed fixed text string according to the value of device. Can display alarms and multiple fixed text strings.
Alarm Log Display	Displays the alarm log stored in the internal memory of the Touch.
Numerical Display	Displays the numerical in the specified format.
Calendar	Displays the date and time using the Touch's calendar data.

3.4 Charts

Part	Description
Bar Chart	Displays values of devices in a Bar Chart.
Line Chart	Displays data logs and values of devices in a Line Chart.
Pie Chart	Displays values of devices in a Pie Chart.
Meter	Displays values of devices using a needle gauge.

3.5 Commands

Part	Description
Bit Write Command	Writes a 0 or 1 to a bit device when certain trigger conditions are satisfied.
Word Write Command	Writes a value to a word device when certain trigger conditions are satisfied. Can be used to indirectly specify the destination address or to perform operations on the written value.
Goto Screen Command	Switches to another screen or displays a window when certain trigger conditions are satisfied.
Script Command	Executes a script when certain trigger conditions are satisfied.
Multi-Command	Executes multiple commands at once when certain trigger conditions are satisfied.
Timer	Starts a countdown when certain trigger conditions are satisfied, and writes 1 to an internal device (HMI Timer Relay LTC) after the set time has elapsed.

Chapter 6 Drawings

This chapter describes the procedures for drawing with shapes and the procedures for configuring pictures and text.

1 Shapes

1.1 Line

● Line Drawing Procedure

This section describes the procedure for drawing lines.

- 1 On the **Home** tab, in the **Drawings** group, click **Shapes**, and then click  (Line) under **Basic Shapes**.

The mouse cursor changes to  (pencil).

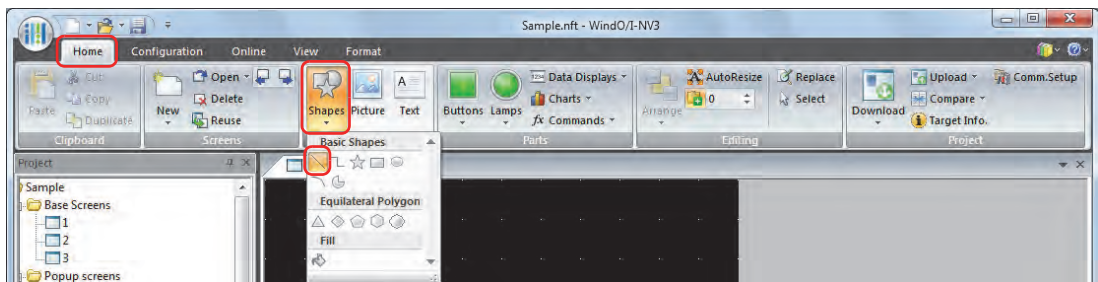

- 2 Click and hold the mouse button at the location (starting point) to start drawing the line on the edit screen.

- 3 Drag the mouse to the ending point location.

A line is drawn that connects the starting point and ending point.

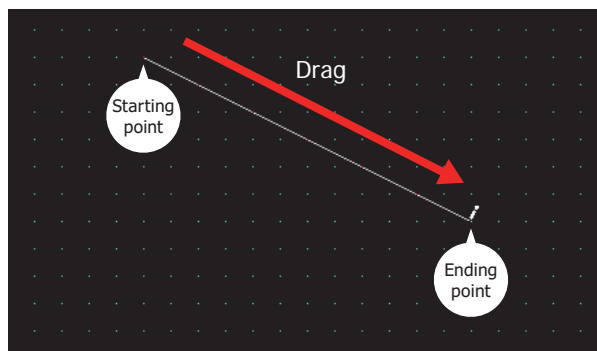

To change the style of the drawn line, perform one of the following operations.

- Double click the line to open the Properties dialog box
- Select the line and select the style with **Shape Style** on the **Format** tab
- Select the line and right click to display the popup menu

● Properties of Line Dialog Box

This section describes items and buttons in the Properties dialog box.

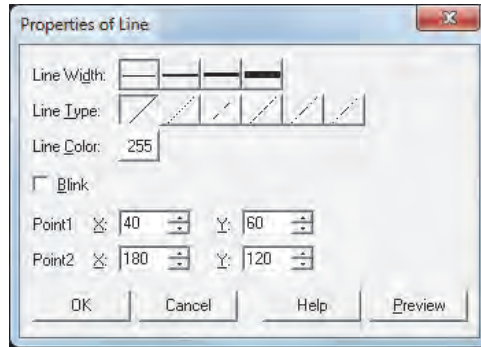

■ Line Width

Selects the line width for the line from the following.

1 dot, 2 dots, 3 dots, 5 dots

3 dots and **5 dots** can only be configured when **Solid** is selected for **Line Type**.

■ Line Type

Selects the line type for the line from the following.

Solid, Dot, Dash, Long Dash, Long Dash Dot, Long Dash Dot Dot

Dot, Dash, Long Dash, Long Dash Dot, and Long Dash Dot Dot can only be configured when **1 dot** or **2 dots** is selected for **Line Width**.

■ Line Color

Selects the line color for the line (color: 256 colors, monochrome: 8 shades).

Click this button to display the Color Palette. Select a color from the Color Palette.

■ Blink

Select this check box to make the line blink.

The blink interval is specified with **Blinking Cycle** on the **System** tab in the Project Settings dialog box.

■ Point1, Point2

X, Y: Specifies the starting point and ending point of the line in coordinates.
The upper-left corner of the screen is the origin.

X: 0 to (Base Screen horizontal size - 1)

Y: 0 to (Base Screen vertical size - 1)

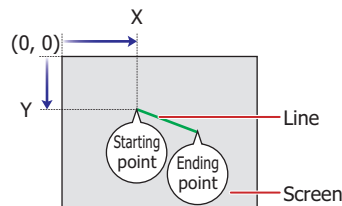

1.2 Polyline

● Polyline Drawing Procedure

This section describes the procedure for drawing polylines.

- 1 On the **Home** tab, in the **Drawings** group, click **Shapes**, and then click  (Polyline) under **Basic Shapes**. The mouse cursor changes to  (pencil).

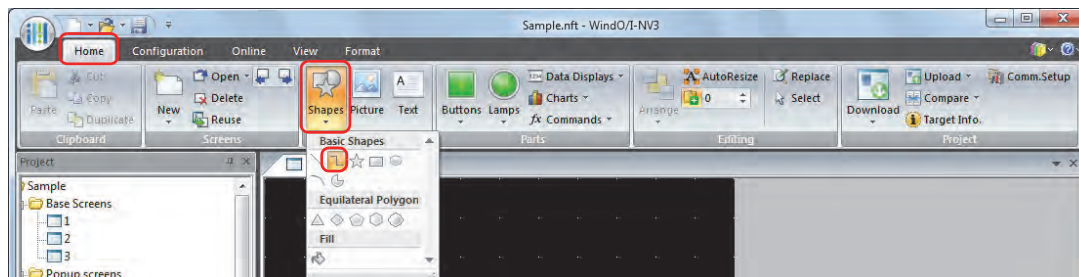

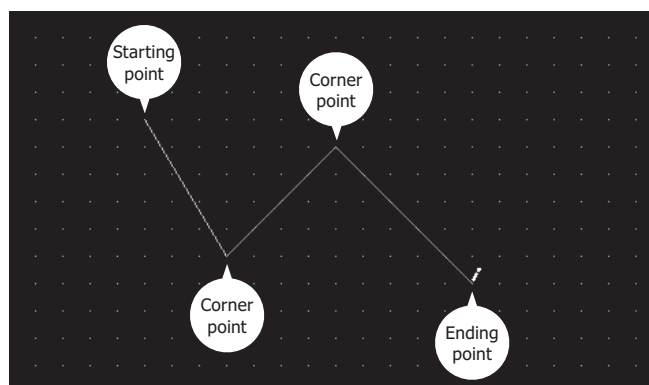

- 2 Click at the location (starting point) to start drawing the polyline on the edit screen.
- 3 Click the corner point locations in order.
A line is drawn that connects the starting point and the various corner point locations in the order that they were created.
- 4 Double click at the ending point location.
A line is drawn that connects the last corner point and the ending point.



The maximum number of corner points in a polyline, including the starting point and the ending point, is 300 points.



- To change the style of the drawn polyline, perform one of the following operations.
 - Double click the polyline to open the Properties dialog box
 - Select the polyline and select the style with **Shape Style** on the **Format** tab
 - Select the polyline and right click to display the popup menu
- To change the starting point, corner points, or the ending point of the drawn polyline, select the polyline and right click on it, and then click **Reshape**.  is displayed on the polyline. Drag  to the desired location. Double click the edit screen or press the key to finish changing the shape.

● Properties of Polyline Dialog Box

This section describes items and buttons in the Properties dialog box.

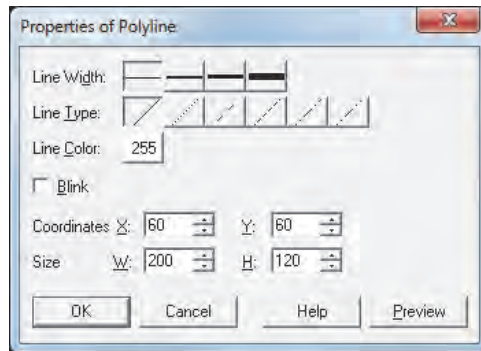

■ Line Width

Selects the line width for the polyline from the following.

1 dot, 2 dots, 3 dots, 5 dots

3 dots and **5 dots** can only be configured when **Solid** is selected for **Line Type**.

■ Line Type

Selects the line type for the polyline from the following.

Solid, Dot, Dash, Long Dash, Long Dash Dot, Long Dash Dot Dot

Dot, Dash, Long Dash, Long Dash Dot, and Long Dash Dot Dot can only be configured when **1 dot** or **2 dots** is selected for **Line Width**.

■ Line Color

Selects the line color for the polyline (color: 256 colors, monochrome: 8 shades).

Click this button to display the Color Palette. Select a color from the Color Palette.

■ Blink

Select this check box to make the polyline blink.

The blink interval is specified with **Blinking Cycle** on the **System** tab in the Project Settings dialog box.

■ Coordinates

X, Y: Specifies the display position of the polyline in coordinates.

With the upper-left corner of the screen as the origin, the upper-left corner of the rectangle that circumscribes the polyline is the X and Y coordinates.

X: 0 to (Base Screen horizontal size - 1)

Y: 0 to (Base Screen vertical size - 1)

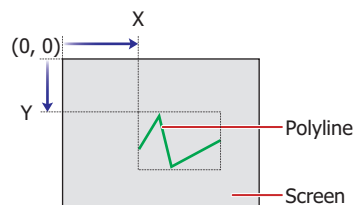

■ Size

W, H: Specifies the size of the polyline in width and height.

W: 1 to (Base Screen horizontal size)

H: 1 to (Base Screen vertical size)

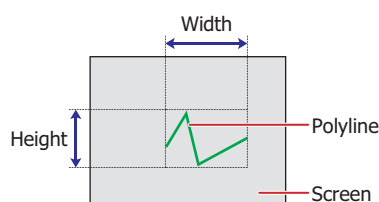

1.3 Polygon

● Polygon Drawing Procedure

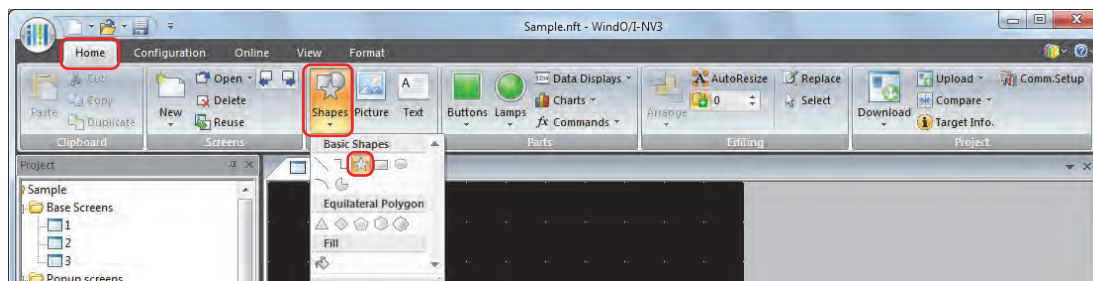

This section describes the procedure for drawing polygons.

- 1 On the **Home** tab, in the **Drawings** group, click **Shapes**, and then click  (Polygon) under **Basic Shapes**.
The mouse cursor changes to  (pencil).

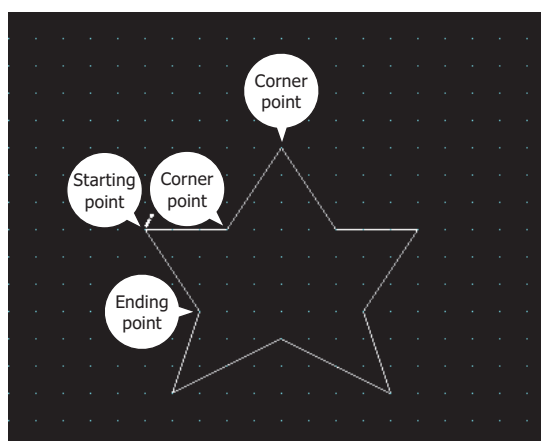

- 2 Click at the location (starting point) to start drawing the polygon on the edit screen.
- 3 Click the corner point locations in order.
A line is drawn that connects the starting point and the various corner point locations in the order that they were created.
- 4 Double click at the ending point location.
A polygon is drawn with the starting point and ending point connected.



- To change the style of the drawn polygon, perform one of the following operations.
 - Double click the polygon to open the Properties dialog box
 - Select the polygon and select the style with **Shape Style** on the **Format** tab
 - Select the polygon and right click to display the popup menu
- To change the starting point, corner points, or the ending point of the drawn polygon, select the polygon and right click on it, and then click **Reshape**.  is displayed on the polygon. Drag  to the desired location. Double click the edit screen or press the **Esc** key to finish changing the shape.

● Properties of Polygon Dialog Box

This section describes items and buttons in the Properties dialog box.

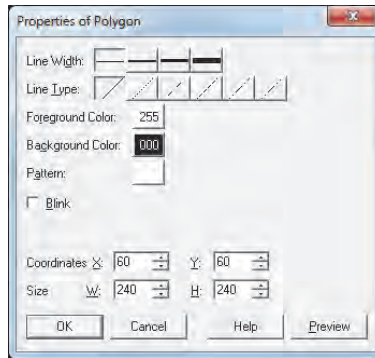

■ Line Width

Selects the line width for the polygon from the following.

1 dot, 2 dots, 3 dots, 5 dots

3 dots and **5 dots** can only be configured when **Solid** is selected for **Line Type**.

■ Line Type

Selects the line type for the polygon from the following.

Solid, Dot, Dash, Long Dash, Long Dash Dot, Long Dash Dot Dot

Dot, Dash, Long Dash, Long Dash Dot, and Long Dash Dot Dot can only be configured when **1 dot** or **2 dots** is selected for **Line Width**.

■ Foreground Color, Background Color

Selects the foreground color and the background color to use for the polygon (color: 256 colors, monochrome: 8 shades).

Click either button to display the Color Palette. Select a color from the Color Palette.

■ Pattern

Selects the pattern for the polygon.

Click this button to display the Pattern Palette. Select a pattern from the Pattern Palette.

■ Blink

Select this check box to make the polygon blink.

The blink interval is specified with **Blinking Cycle** on the **System** tab in the Project Settings dialog box.

■ Coordinates

X, Y: Specifies the display position of the polygon in coordinates.

With the upper-left corner of the screen as the origin, the upper-left corner of the rectangle that circumscribes the polygon is the X and Y coordinates.

X: 0 to (Base Screen horizontal size - 1)

Y: 0 to (Base Screen vertical size - 1)

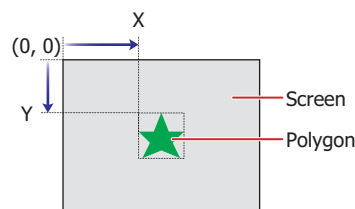

■ Size

W, H: Specifies the size of the polygon in width and height.

W: 1 to (Base Screen horizontal size)

H: 1 to (Base Screen vertical size)

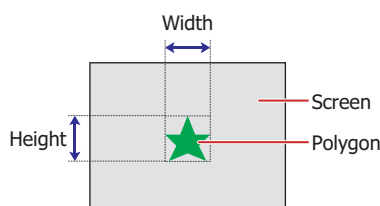

1.4 Rectangle

● Rectangle Drawing Procedure

This section describes the procedure for drawing rectangles.

- 1 On the **Home** tab, in the **Drawings** group, click **Shapes**, and then click  (Rectangle) under **Basic Shapes**. The mouse cursor changes to  (pencil).

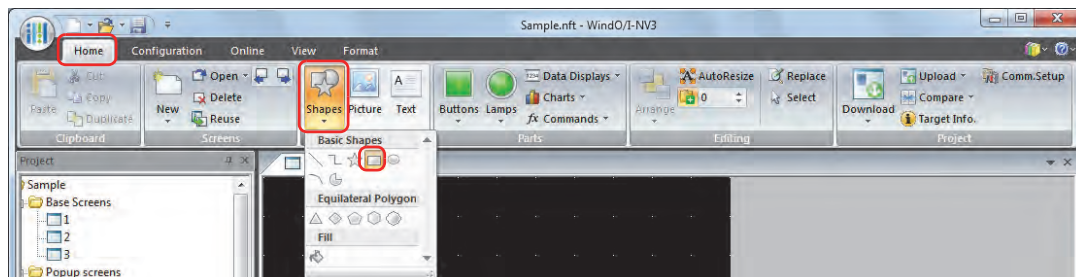

- 2 Click and hold the mouse button at the location (starting point) to start drawing the rectangle on the edit screen.
- 3 Drag the mouse to the ending point location so that location becomes the opposite angle of the rectangle. A rectangle is drawn with the starting point and ending point set to opposite angles.

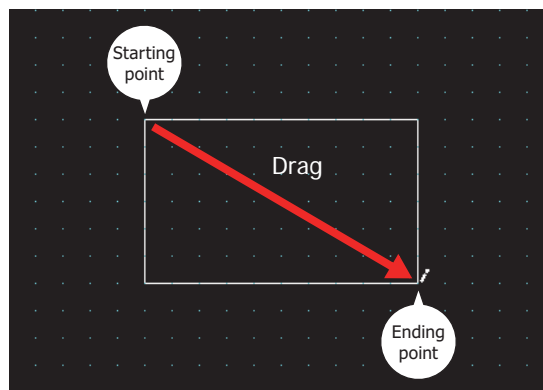

To change the style of the drawn rectangle, perform one of the following operations.

- Double click the rectangle to open the Properties dialog box
- Select the rectangle and select the style with **Shape Style** on the **Format** tab
- Select the rectangle and right click to display the popup menu

● Properties of Rectangle Dialog Box

This section describes items and buttons in the Properties dialog box.

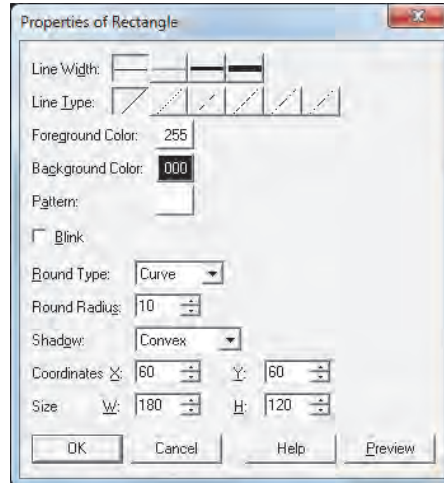

■ Line Width

Selects the line width for the rectangle from the following.

1 dot, 3 dots, 5 dots

3 dots and **5 dots** can only be configured when **Solid** is selected for **Line Type**.

■ Line Type

Selects the line type for the rectangle from the following.

Solid, Dot, Dash, Long Dash, Long Dash Dot, Long Dash Dot Dot

Dot, Dash, Long Dash, Long Dash Dot, and Long Dash Dot Dot can only be configured when **1 dot** is selected for **Line Width**.

■ Foreground Color, Background Color

Selects the foreground color and the background color to use for the rectangle (color: 256 colors, monochrome: 8 shades).

Click either button to display the Color Palette. Select a color from the Color Palette.

■ Pattern

Selects the pattern for the rectangle.

Click this button to display the Pattern Palette. Select a pattern from the Pattern Palette.

■ Blink

Select this check box to make the rectangle blink.

The blink interval is specified with **Blinking Cycle** on the **System** tab in the Project Settings dialog box.

■ Round Type

Selects the style of the rectangle's corners from the following.

None, Curve, Straight

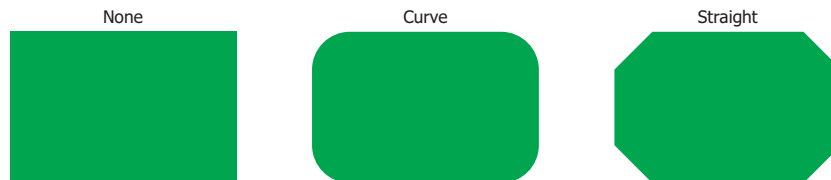

■ Round Radius

Specifies the rounding radius (1 to 200). However, the range that can be configured is where round radius x 2 is a value smaller than **Size W** and **Size H**.

This option can only be configured when **Curve** or **Straight** is selected for **Round Type**.

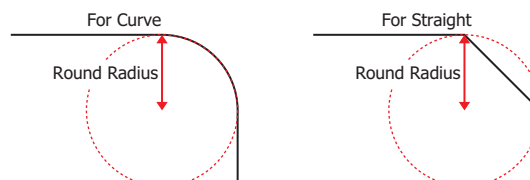

■ Shadow

Selects the style of shadow attached to the rectangle from the following. This option draws the rectangle in a three-dimensional manner.

None, Convex, Concave

This option can only be configured when **1 dot** is selected for **Line Width** and **Solid** is selected for **Line Type**.

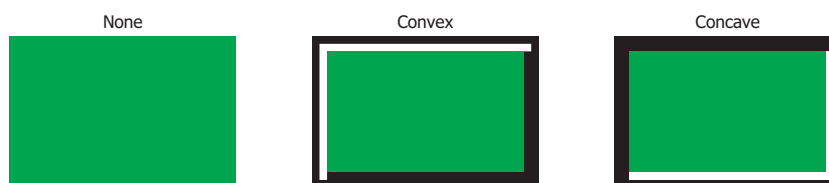

■ Coordinates

X, Y: Specifies the display position of the rectangle in coordinates.

With the upper-left corner of the screen as the origin, the upper-left corner of the rectangle is the X and Y coordinates.

X: 0 to (Base Screen horizontal size - 1)

Y: 0 to (Base Screen vertical size - 1)

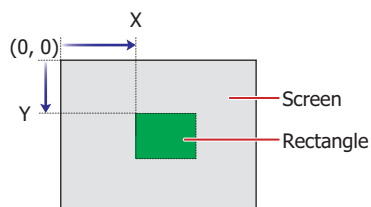

■ Size

W, H: Specifies the size of the rectangle in width and height.

W: 1 to (Base Screen horizontal size)

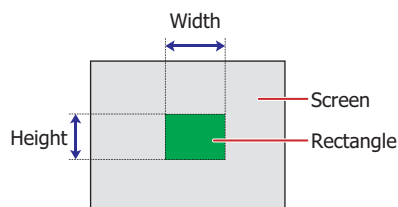

H: 1 to (Base Screen vertical size)



1.5 Circle/Ellipse

● Circle/Ellipse Drawing Procedure

This section describes the procedure for drawing circles and ellipses.

- 1 On the **Home** tab, in the **Drawings** group, click **Shapes**, and then click  (Circle/Ellipse) under **Basic Shapes**. The mouse cursor changes to  (pencil).

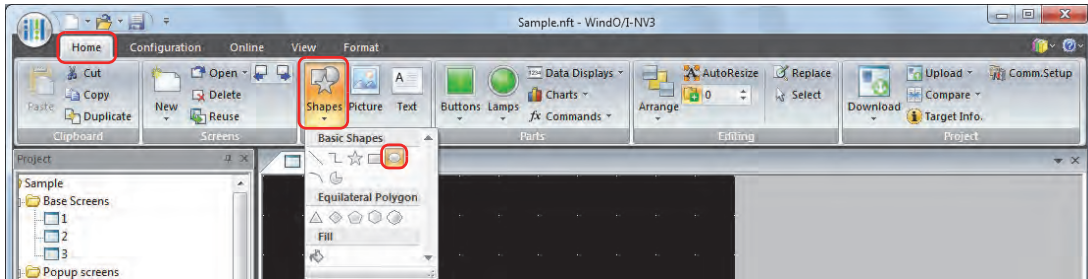

- 2 Click and hold the mouse button at the location (starting point) to start drawing the circle or ellipse on the edit screen.
- 3 Drag the mouse to the ending point location so that location becomes the opposite angle of the rectangle. A circle or ellipse is drawn that inscribes the rectangle made from the opposite angles of the starting point and the ending point.

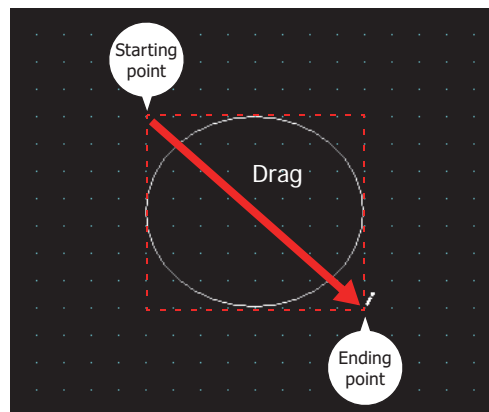

To change the style of the drawn circle or ellipse, perform one of the following operations.

- Double click the circle or ellipse to open the Properties dialog box
- Select the circle or ellipse and select the style with **Shape Style** on the **Format** tab
- Select the circle or ellipse and right click to display the popup menu

● Properties of Circle/Ellipse Dialog Box

This section describes items and buttons in the Properties dialog box.

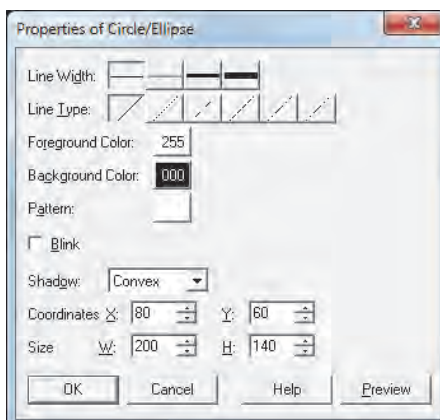

■ Line Width

Selects the line width for the circle or ellipse from the following.

1 dot, 3 dots, 5 dots

3 dots and **5 dots** can only be configured when **Solid** is selected for **Line Type**.

■ Line Type

Selects the line type for the circle or ellipse from the following.

Solid, Dot, Dash, Long Dash, Long Dash Dot, Long Dash Dot Dot

Dot, Dash, Long Dash, Long Dash Dot, and Long Dash Dot Dot can only be configured when **1 dot** is selected for **Line Width**.

■ Foreground Color, Background Color

Selects the foreground color and the background color to use for the circle or ellipse (color: 256 colors, monochrome: 8 shades).

Click either button to display the Color Palette. Select a color from the Color Palette.

■ Pattern

Selects the pattern for the circle or ellipse.

Click this button to display the Pattern Palette. Select a pattern from the Pattern Palette.

■ Blink

Select this check box to make the circle or ellipse blink.

The blink interval is specified with **Blinking Cycle** on the **System** tab in the Project Settings dialog box.

■ Shadow

Selects the style of shadow attached to the circle or ellipse from the following. This option draws the circle or ellipse in a three-dimensional manner.

None, Convex, Concave

This option can only be configured when **1 dot** is selected for **Line Width** and **Solid** is selected for **Line Type**.

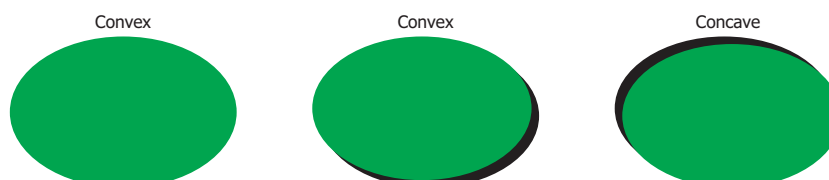

■ Coordinates

X, Y: Specifies the display position of the circle or ellipse in coordinates.

With the upper-left corner of the screen as the origin, the upper-left corner of the rectangle that circumscribes the circle or ellipse is the X and Y coordinates.

X: 0 to (Base Screen horizontal size - 1)

Y: 0 to (Base Screen vertical size - 1)

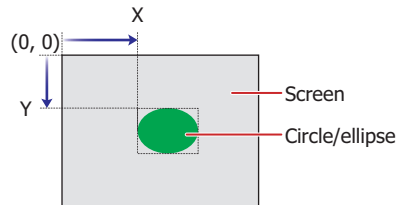

■ Size

W, H: Specifies the size of the circle or ellipse in width and height.

W: 3 to (Base Screen horizontal size)

H: 3 to (Base Screen vertical size)

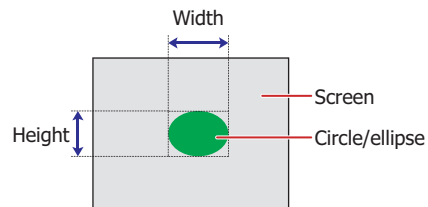

1.6 Arc

● Arc Drawing Procedure

This section describes the procedure for drawing arcs.

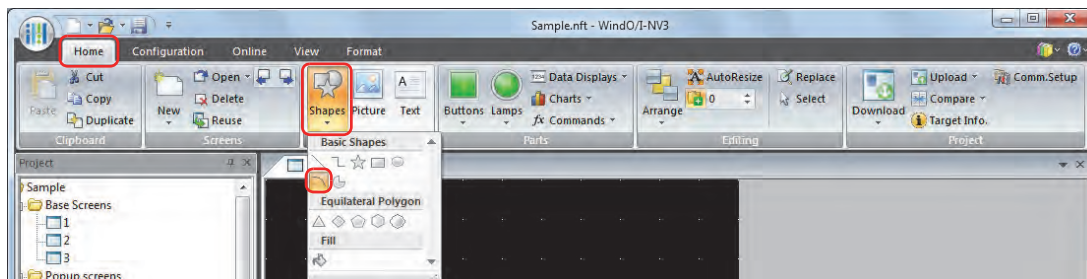

- 1 On the **Home** tab, in the **Drawings** group, click **Shapes**, and then click  (Arc) under **Basic Shapes**.

The mouse cursor changes to  (pencil).

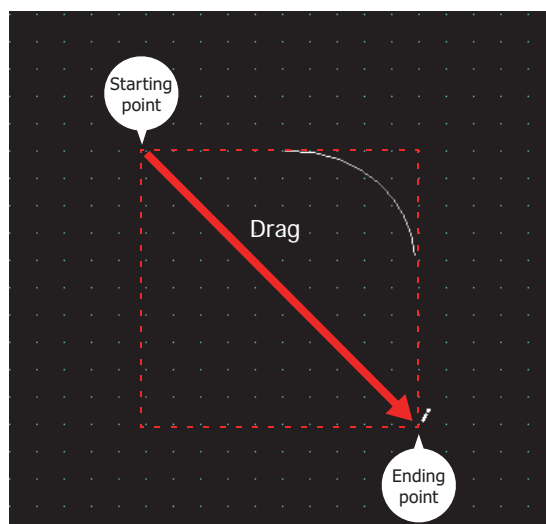

- 2 Click and hold the mouse button at the location (starting point) to start drawing the arc on the edit screen.
- 3 Drag the mouse to the ending point location so that location becomes the opposite angle of the rectangle. An arc is drawn that inscribes the rectangle made from the opposite angles of the starting point and the ending point.



- To change the style of the drawn arc, perform one of the following operations.
 - Double click the arc to open the Properties dialog box
 - Select the arc and select the style with **Shape Style** on the **Format** tab
 - Select the arc and right click to display the popup menu
- To change the starting point or the ending point of the drawn arc, select the arc and right click on it, and then click **Reshape**.  is displayed on the arc. Drag  to the desired location. Double click the edit screen or press the key to finish changing the shape.

● Properties of Arc Dialog Box

This section describes items and buttons in the Properties dialog box.

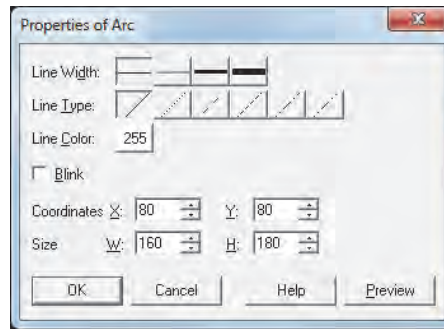

■ Line Width

Selects the line width for the arc from the following.

1 dot, 3 dots, 5 dots

3 dots and **5 dots** can only be configured when **Solid** is selected for **Line Type**.

■ Line Type

Selects the line type for the arc from the following.

Solid, Dot, Dash, Long Dash, Long Dash Dot, Long Dash Dot Dot

Dot, Dash, Long Dash, Long Dash Dot, and Long Dash Dot Dot can only be configured when **1 dot** is selected for **Line Width**.

■ Line Color

Selects the line color for the arc (color: 256 colors, monochrome: 8 shades).

Click this button to display the Color Palette. Select a color from the Color Palette.

■ Blink

Select this check box to make the arc blink.

The blink interval is specified with **Blinking Cycle** on the **System** tab in the Project Settings dialog box.

■ Coordinates

X, Y: Specifies the display position of the arc in coordinates.

With the upper-left corner of the screen as the origin, the upper-left corner of the rectangle that circumscribes the arc is the X and Y coordinates.

X: 0 to (Base Screen horizontal size - 1)

Y: 0 to (Base Screen vertical size - 1)

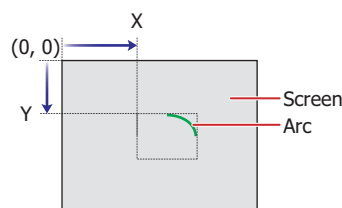

■ Size

W, H: Specifies the size of the arc in width and height.

W: 3 to (Base Screen horizontal size)

H: 3 to (Base Screen vertical size)

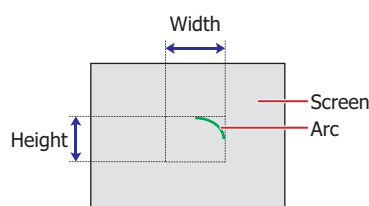

1.7 Pie

● Pie Drawing Procedure

This section describes the procedure for drawing pies.

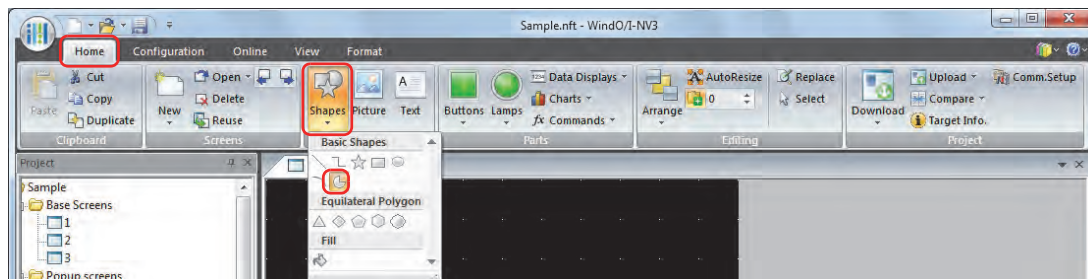

- 1 On the **Home** tab, in the **Drawings** group, click **Shapes**, and then click  (Pie) under **Basic Shapes**.

The mouse cursor changes to  (pencil).

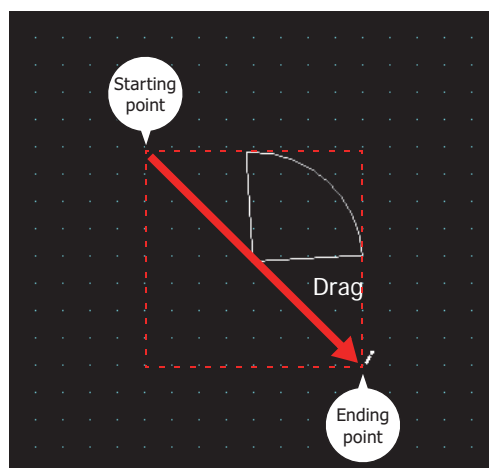

- 2 Click and hold the mouse button at the location (starting point) to start drawing the pie on the edit screen.
- 3 Drag the mouse to the ending point location so that location becomes the opposite angle of the rectangle. A pie is drawn that inscribes the rectangle made from the opposite angles of the starting point and the ending point.



- To change the style of the drawn pie, perform one of the following operations.
 - Double click the pie to open the Properties dialog box
 - Select the pie and select the style with **Shape Style** on the **Format** tab
 - Select the pie and right click to display the popup menu
- To change the central angle of the drawn pie, select the pie and right click on it, and then click **Reshape**.  is displayed on the pie. Drag  to the desired location. Double click the edit screen or press the **Esc** key to finish changing the shape.

● Properties of Pie Dialog Box

This section describes items and buttons in the Properties dialog box.

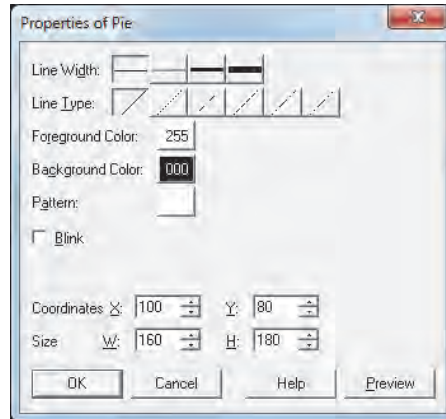

■ Line Width

Selects the line width for the pie from the following.

1 dot, 3 dots, 5 dots

3 dots and **5 dots** can only be configured when **Solid** is selected for **Line Type**.

■ Line Type

Selects the line type for the pie from the following.

Solid, Dot, Dash, Long Dash, Long Dash Dot, Long Dash Dot Dot

Dot, Dash, Long Dash, Long Dash Dot, and Long Dash Dot Dot can only be configured when **1 dot** is selected for **Line Width**.

■ Foreground Color, Background Color

Selects the foreground color and the background color to use for the pie (color: 256 colors, monochrome: 8 shades).

Click either button to display the Color Palette. Select a color from the Color Palette.

■ Pattern

Selects the pattern for the pie.

Click this button to display the Pattern Palette. Select a pattern from the Pattern Palette.

■ Blink

Select this check box to make the pie blink.

The blink interval is specified with **Blinking Cycle** on the **System** tab in the Project Settings dialog box.

■ Coordinates

X, Y: Specifies the display position of the pie in coordinates.

With the upper-left corner of the screen as the origin, the upper-left corner of the rectangle that circumscribes the circle with the same center as the pie is the X and Y coordinates.

X: 0 to (Base Screen horizontal size - 1)

Y: 0 to (Base Screen vertical size - 1)

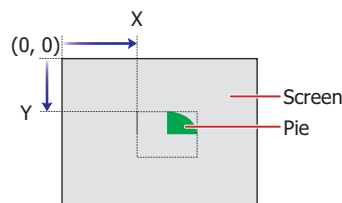

■ Size

W, H: Specifies the size of the pie in width and height.

W: 3 to (Base Screen horizontal size)



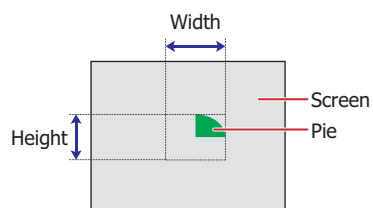

H: 3 to (Base Screen vertical size)



1.8 Equilateral Polygons

● Equilateral Polygons Drawing Procedure

This section describes the procedure to draw equilateral polygons (equilateral triangle, equilateral diamond, equilateral pentagon, equilateral hexagon, equilateral octagon).

- 1 On the **Home** tab, in the **Drawings** group, click **Shapes**, and then click  (Equilateral Triangle),  (Equilateral Diamond),  (Equilateral Pentagon),  (Equilateral Hexagon), or  (Equilateral Octagon) under **Equilateral Polygons**.

The mouse cursor changes to  (pencil).

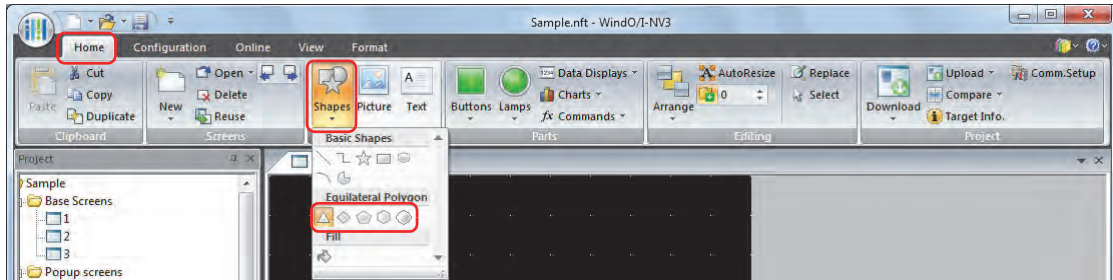

- 2 Click and hold the mouse button at the location (starting point) on the edit screen to start drawing the square that will circumscribe the equilateral polygon.
- 3 Drag the mouse to the ending point location so that location becomes the opposite angle of the square. An equilateral polygon is drawn that inscribes the square made from the opposite angles of the starting point and the ending point.

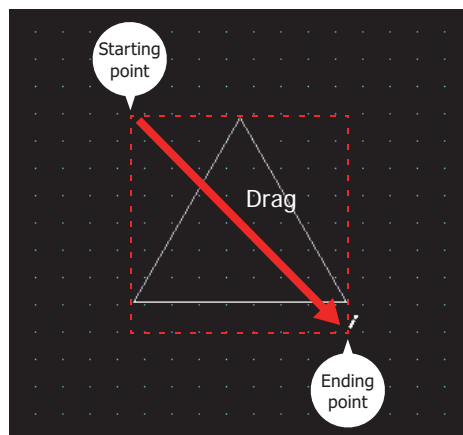

To change the style of the drawn square, perform one of the following operations.

- Double click the square to open the Properties dialog box
- Select the square and select the style with **Shape Style** on the **Format** tab
- Select the square and right click to display the popup menu

● Properties of Equilateral Polygon Dialog Box

This section describes items and buttons in the Properties dialog box.

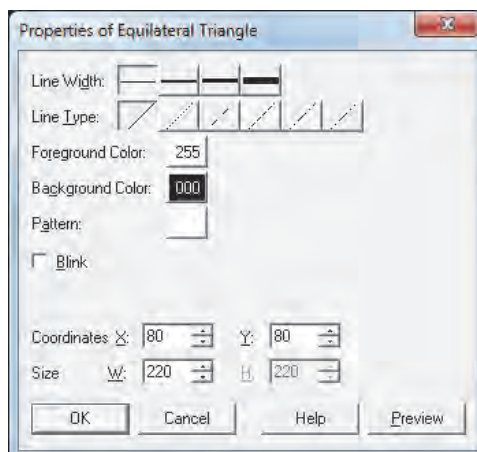

■ Line Width

Selects the line width for the equilateral polygon from the following.

1 dot, 2 dots, 3 dots, 5 dots

3 dots and **5 dots** can only be configured when **Solid** is selected for **Line Type**.

■ Line Type

Selects the line type for the equilateral polygon from the following.

Solid, Dot, Dash, Long Dash, Long Dash Dot, Long Dash Dot Dot

Dot, Dash, Long Dash, Long Dash Dot, and Long Dash Dot Dot can only be configured when **1 dot** or **2 dots** is selected for **Line Width**.

■ Foreground Color, Background Color

Selects the foreground color and the background color to use for the equilateral polygon (color: 256 colors, monochrome: 8 shades).

Click either button to display the Color Palette. Select a color from the Color Palette.

■ Pattern

Selects the pattern for the equilateral polygon.

Click this button to display the Pattern Palette. Select a pattern from the Pattern Palette.

■ Blink

Select this check box to make the equilateral polygon blink.

The blink interval is specified with **Blinking Cycle** on the **System** tab in the Project Settings dialog box.

■ Coordinates

X, Y: Specifies the display position of the equilateral polygon in coordinates.

With the upper-left corner of the screen as the origin, the upper-left corner of the square that circumscribes the equilateral polygon is the X and Y coordinates.

X: 0 to (Base Screen horizontal size - 1)

Y: 0 to (Base Screen vertical size - 1)

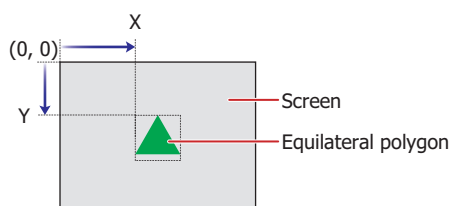

■ **Size**

W, H: Specifies the size of the equilateral polygon in width and height.

W: 1 to (Base Screen horizontal size)

H: 1 to (Base Screen vertical size)

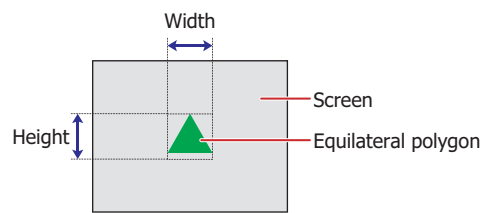

1.9 Fill

● Fill Configuration Procedure

This section describes the fill configuration procedure.

- 1 On the **Home** tab, in the **Drawings** group, click **Shapes**, and then click  (Fill) under **Fill**.

The mouse cursor changes to  (pencil).

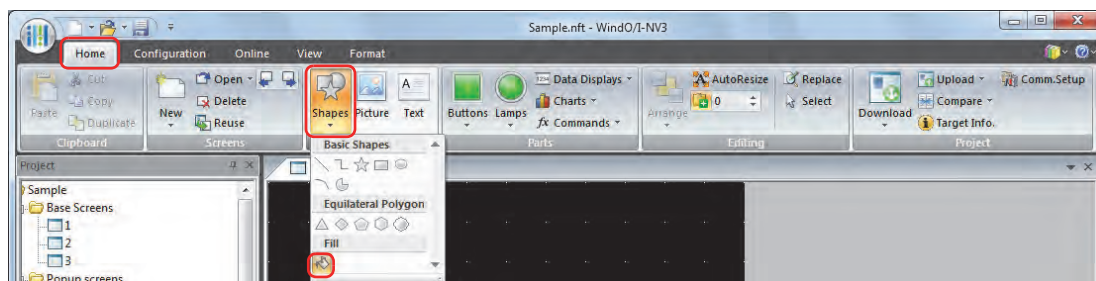

- 2 Click on a section where multiple shapes overlap on the edit screen.

The section where multiple shapes overlap is filled with the **Foreground Color**, **Background Color**, and **Pattern** of the shape last drawn or the shape that last had its style changed. The clicked location is the fill starting point.

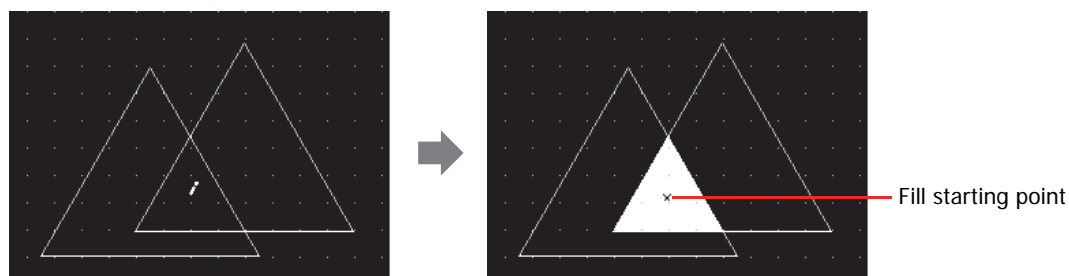

- To change the fill style, perform one of the following operations.
 - Double click the fill starting point to open the Properties dialog box
 - Select the fill starting point and select the style with **Shape Style** on the **Format** tab
 - Select the fill starting point and right click to display the popup menu
- If you move the fill starting point, the closed region where it was moved to is filled.

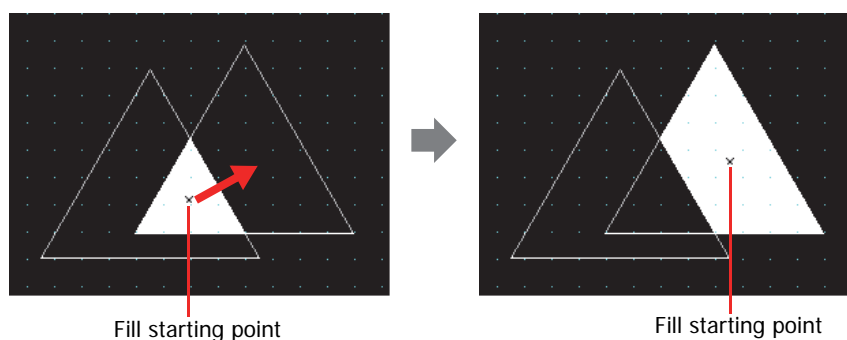

- To select the fill starting point, click  on the edit screen or select Fill on the **Object List** window.

● Properties of Fill Dialog Box

This section describes items and buttons in the Properties dialog box.

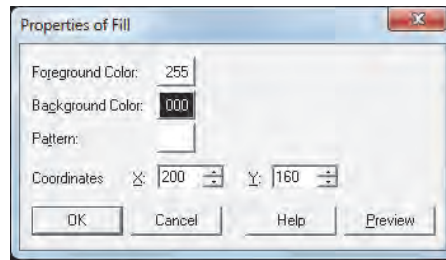

■ Foreground Color, Background Color

Selects the foreground color and the background color to fill with (color: 256 colors, monochrome: 8 shades). Click either button to display the Color Palette. Select a color from the Color Palette.

■ Pattern

Selects the pattern to fill with.

Click this button to display the Pattern Palette. Select a pattern from the Pattern Palette.

■ Coordinates

X, Y: Specifies the display position of the fill start position in coordinates. The upper-left corner of the screen is the origin.

X: 0 to (Base Screen horizontal size - 1)

Y: 0 to (Base Screen vertical size - 1)

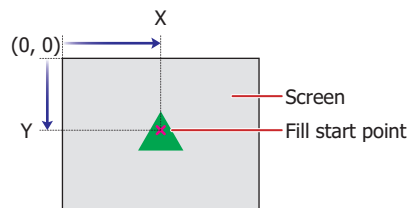

2 Picture

2.1 Picture Configuration Procedure

This section describes the picture configuration procedure.

- 1 On the **Home** tab, in the **Drawings** group, click **Picture**.

The mouse cursor changes to  (picture).

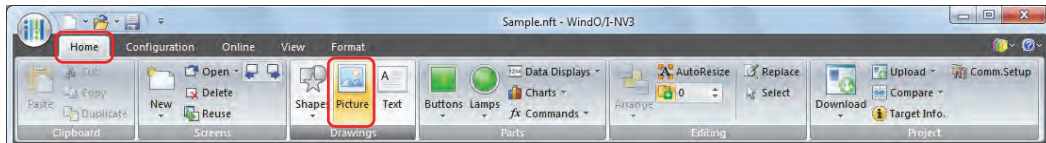

- 2 Click the location on the edit screen to place the picture.
Picture Manager is displayed.
- 3 Select a picture, and then click **Select**.
The selected picture, is placed on the screen.

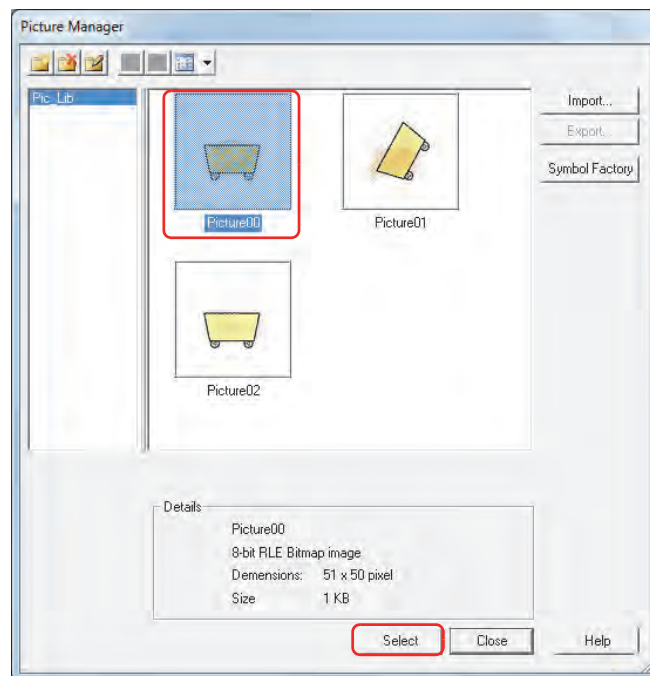

To change the picture that was placed on the screen, perform one of the following operations.

- Double click the picture to open the Properties dialog box, and then click **Browse**
- Replace the picture in Picture Manager

2.2 Properties of Picture Dialog Box

This section describes items and buttons in the Properties dialog box.

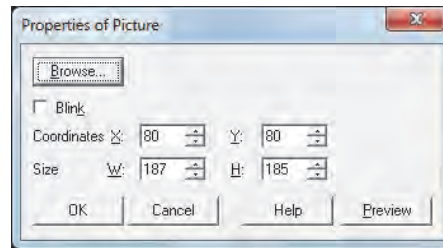

■ Browse

Changes the picture placed on the screen. Click this button to display Picture Manager.

■ Blink

Select this check box to make the picture blink.

The blink interval is specified with **Blinking Cycle** on the **System** tab in the Project Settings dialog box.

■ Coordinates

X, Y: Specifies the display position of the picture in coordinates.

With the upper-left corner of the screen as the origin, the upper-left corner of the rectangle that circumscribes the picture is the X and Y coordinates.

X: 0 to (Base Screen horizontal size - 1)

Y: 0 to (Base Screen vertical size - 1)

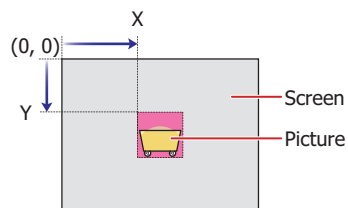

■ Size

W, H: Specifies the size of the picture in width and height.

W: 1 to (Base Screen horizontal size)

H: 1 to (Base Screen vertical size)

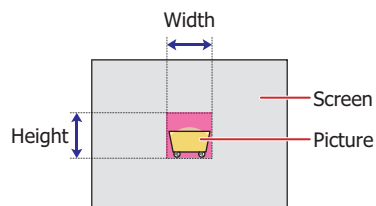

3 Text

3.1 Text Configuration Procedure

This section describes the configuration procedure for text.

- 1 On the **Home** tab, in the **Drawings** group, click **Text**.

The mouse cursor changes to  (text).

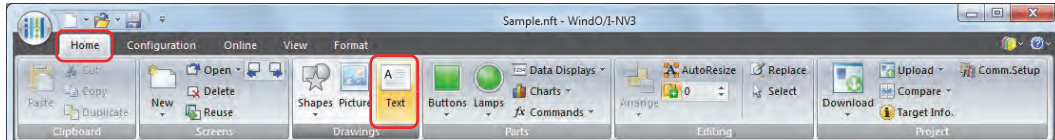

- 2 Click the location on the edit screen to place the text.
The Properties of Text dialog box is displayed.
- 3 Enter the text to display in **Text** and configure the options as necessary.
The maximum number is 3,750 characters.

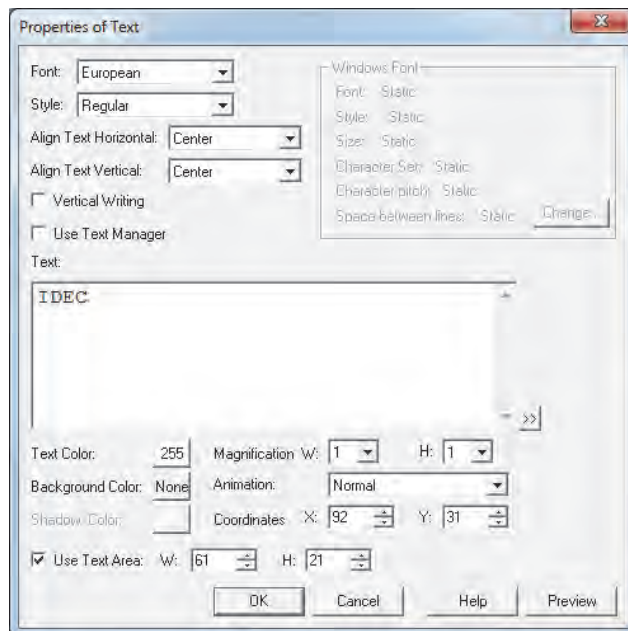

- 4 Click **OK**.

The text is placed on the screen.



To change the style of the text placed on the screen, perform one of the following operations. You can change the entered text in the Properties dialog box.

- Double click the text to open the Properties dialog box
- Select the text and select the style with **Text Style** on the **Format** tab
- Select the text and right click to display the popup menu

3.2 Properties of Text dialog box

This section describes items and buttons in the Properties dialog box.

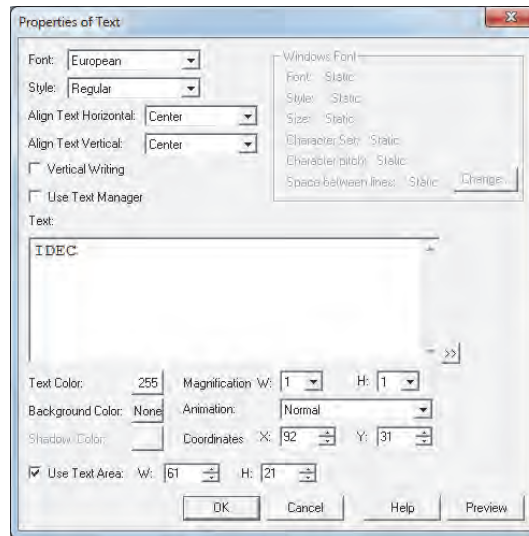

■ Font

Selects the font to use to display text from the following.

Japanese, European, Chinese, Taiwanese, Korean, Central European, Baltic, Cyrillic, Windows

This option can only be configured if the **Use Text Manager** check box is cleared.

■ Style

Selects the style of text from the following.

Regular, Bold, Shadow

This option can only be configured when **Japanese, European, Chinese, Taiwanese, Korean, Central European, Baltic,** or **Cyrillic** is selected for **Font**.

■ Align Text Horizontal

Selects text alignment in the horizontal direction.

Left, Center, Right, Center-Left

For details, refer to Appendix "5 Text Alignment" on page A-5.

■ Align Text Vertical

Selects text alignment in the vertical direction.

Top, Center, Bottom

Top when the **Vertical Writing** check box is selected.

For details, refer to Appendix "5 Text Alignment" on page A-5.

■ Vertical Writing

Select this check box to display text vertically.

This option can only be configured when **Japanese, European, Chinese, Taiwanese, Korean, Central European, Baltic,** or **Cyrillic** is selected for **Font**.



When the **Vertical Writing** check box is selected, take care about the following points. This is applicable for installations of Windows that support East Asian characters.

- When there is a mixture of double-byte and single-byte characters, the half-width characters are left-aligned.

◆ Aligned to
A left edge
B
C
D
E
F

- Dashes are displayed horizontally. Symbols representing voiced and semi-voiced sounds of single-byte characters are shown as follows.

Horizontal display	X	o	
	-	'	
	a	c	Next
	x		characters
	i	o	
	s	c	
		k	

■ Windows Font

Configures the font to use as the Windows Font.

Select **Windows** for **Font** to display the current settings. To change the settings, click **Change** to display the Font Settings dialog box.

This option can only be configured if the **Use Text Manager** check box is cleared.

For details, refer to Chapter 2 “Windows Font” on page 2-12.

■ Use Text Manager

Select this check box to use text registered in Text Manager.

■ Text ID

Specifies the Text Manager ID number (1 to 32000) when using text registered in Text Manager.

Click  to display Text Manager.

This option can only be configured when the **Use Text Manager** check box is selected.

■ Text

Enter the text to display. The maximum number is 3,750 characters.

The characters that can be entered vary based on the font selected by **Font**. For details, refer to Chapter 2 “1.2 Available Text” on page 2-5.

This option can only be configured if the **Use Text Manager** check box is cleared.



- To enter Unicode characters, click  to display the Unicode Input dialog box. Enter the characters in the Unicode Input dialog box, and then click **OK**.
- A newline is counted as two characters.

■ Text Color

Selects the color for the displayed text (color: 256 colors, monochrome: 8 shades).

Click this button to display the Color Palette. Select a color from the Color Palette.

■ Magnification

W, H: Selects the zoom factor for characters (0.5, 1 to 8).

This option can only be configured when **Japanese, European, Chinese, Taiwanese, Korean, Central European, Baltic, or Cyrillic** is selected for **Font**.

■ Background Color

Selects the background color for the text (color: 256 colors, monochrome: 8 shades).

Click this button to display the Color Palette. Select a color from the Color Palette.

■ Animation

Selects whether or not to make the text blink.

Normal: The text does not blink.

Blink: The text blinks.

■ Shadow Color

Selects the shadow color for the text (color: 256 colors, monochrome: 8 shades).

Click this button to display the Color Palette. Select a color from the Color Palette.

This option can only be configured when **Shadow** is selected for **Style**.

■ Coordinates

X, Y: Specifies the display position of the text or the text area in coordinates.

With the upper-left corner of the screen as the origin, the upper-left corner of the rectangle that circumscribes the text or the upper-left corner of the text area is the X and Y coordinates.

When the **Use Text Area** check box is cleared, the coordinates are for the text. When the **Use Text Area** check box is selected, the coordinates are for the text area.

X: 0 to (Base Screen horizontal size - 1)

Y: 0 to (Base Screen vertical size - 1)

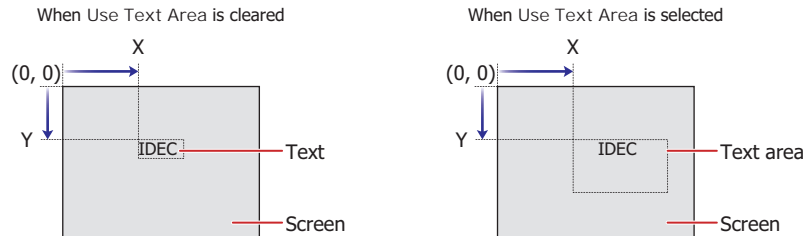

■ Use Text Area

Select this check box to specify a text area and adjust the display position of the text with the specified text area.

W, H: Specifies the size of the text area in width and height.

W: 1 to (Base Screen horizontal size)

H: 1 to (Base Screen vertical size)

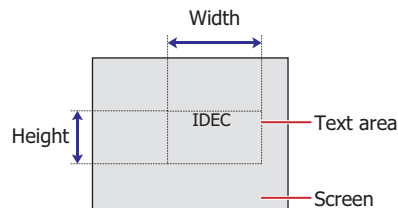

Chapter 7 Buttons

This chapter describes the setup for the button parts and related Touch operations.

1 Bit Button

1.1 How the Bit Button is Used

Writes a 0 or 1 to a bit device.

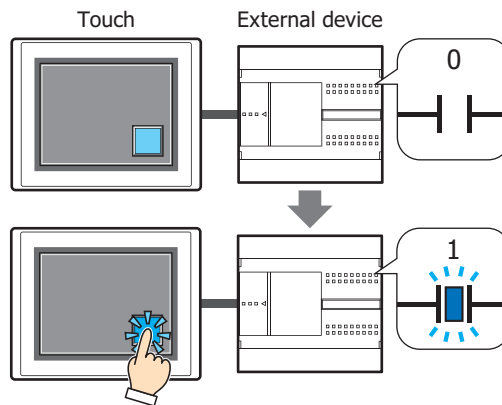

■ Set

Pressing the button writes a 1 to the bit device.

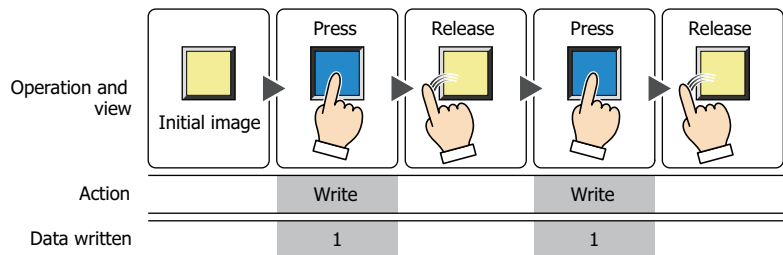

■ Reset

Pressing the button writes a 0 to the bit device.

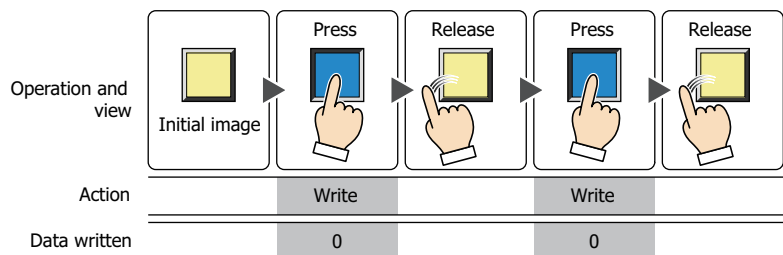

■ **Momentary**

Pressing the button writes a 1 to the bit device.
 Releasing the button writes a 0 to the bit device.

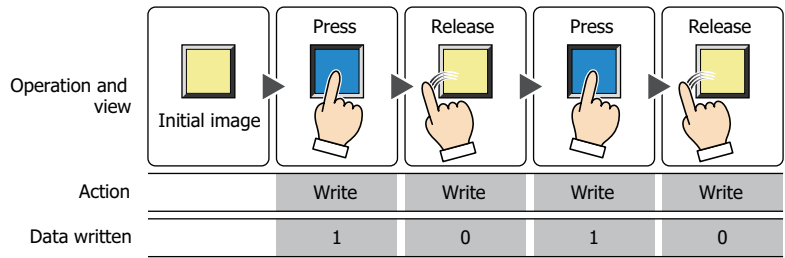

Pressing and holding the button until the screen changes causes a 0 to be written to the bit device.

■ **Alternate**

Each press of the button alternately writes a 1 or 0 to the bit device.

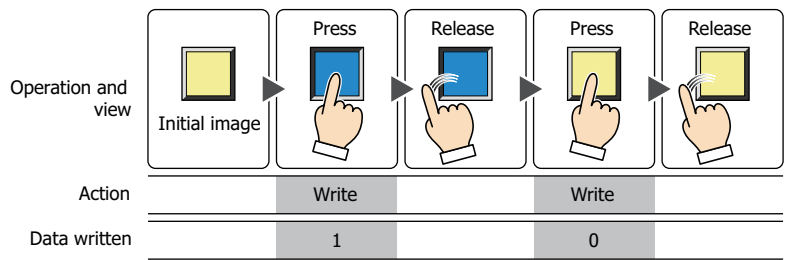

■ **Toggle**

Pressing the button inverts the value of the bit device.
 If the value of the bit device is 0 it changes to 1, and vice versa.

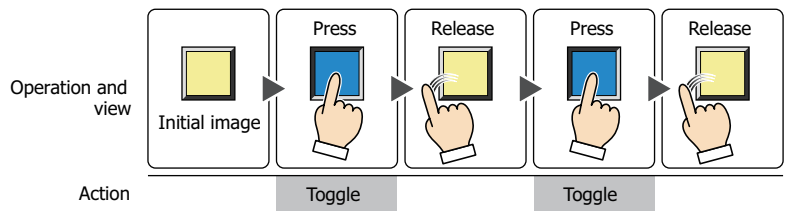

■ **Move**

Pressing the button writes the value in the source bit device to the value in the destination bit device.

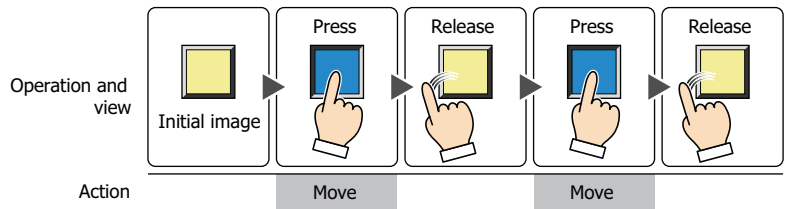

1.2 Bit Button Configuration Procedure

This section describes the configuration procedure for Bit Buttons.

- 1 On the **Home** tab, in the **Parts** group, click **Buttons**, and then click **Bit Button**.

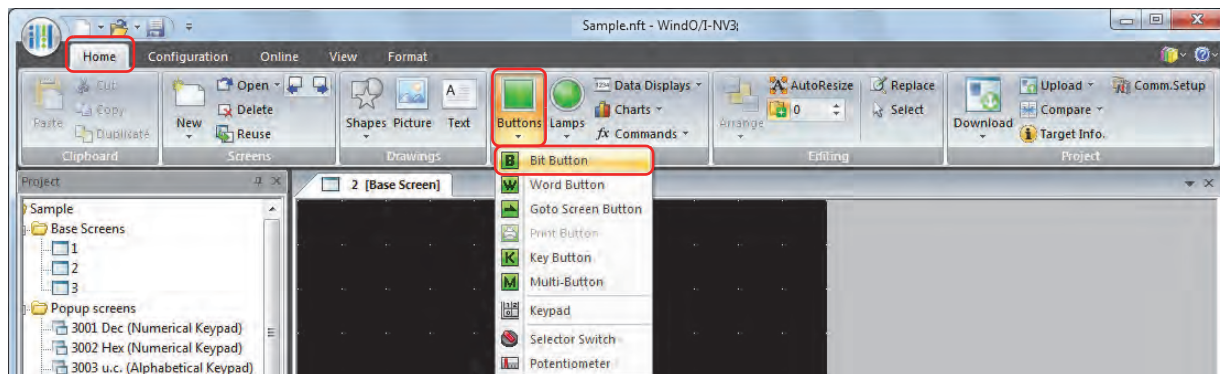

- 2 Click a point on the edit screen where you want to place the Bit Button.
- 3 Double-click the dropped Bit Button and a Properties dialog box will be displayed.
- 4 Change the settings on each tab as necessary.

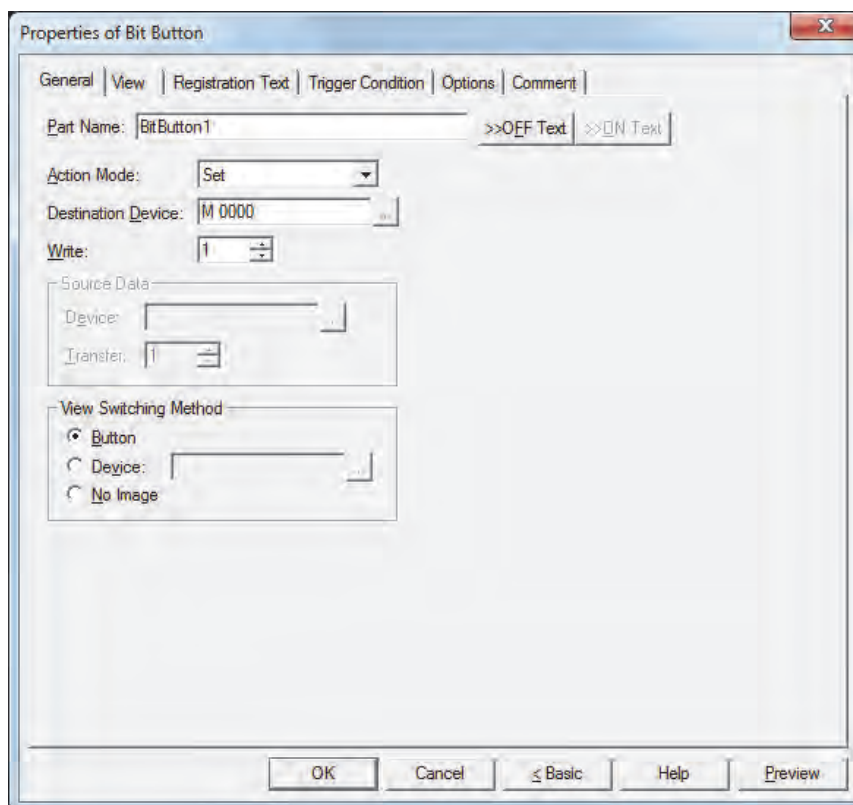

The **Trigger Condition** tab and **Options** tab only appear in Advanced mode.

To switch to Advanced mode, click **Advanced**.

1.3 Properties of Bit Button Dialog Box

This section describes items and buttons in the Properties dialog box.

● **General Tab**

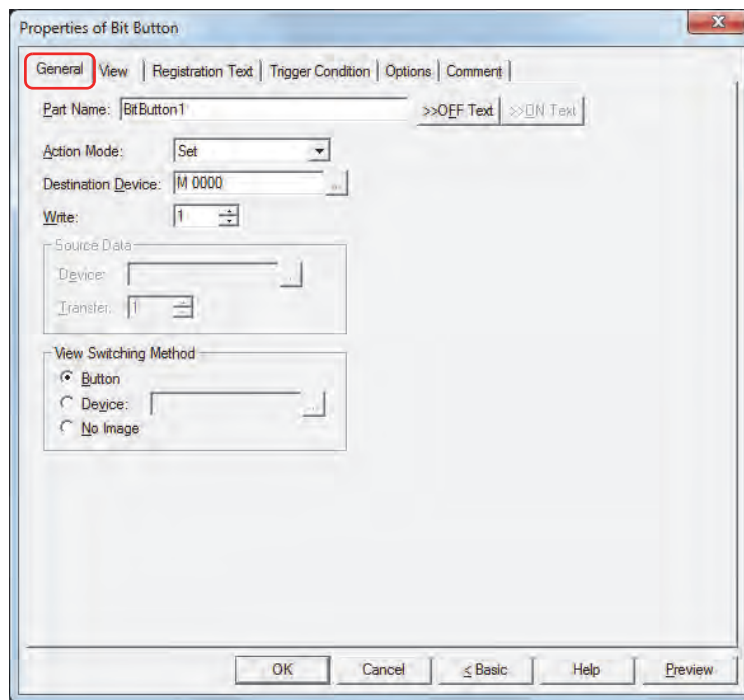

■ **Part Name**

Enter a name for the part. The maximum number is 20 characters.

■ **>>OFF Text, >>ON Text**

Applies the text entered in the **Part Name** field to the **Text** field under the **OFF** or **ON** fields on the **Registration Text** tab. This is used as the Registration Text when the button is OFF or ON.



To specify the Registration Text to use when the button is ON, select the **Set by State** check box on the **Registration Text** tab. If left unchecked, the same Registration Text assigned for the OFF state is displayed for the ON state as well.

■ **Action Mode**

Select the behavior of the button from the following:

Set: Pressing the button writes a 1 to the bit device.

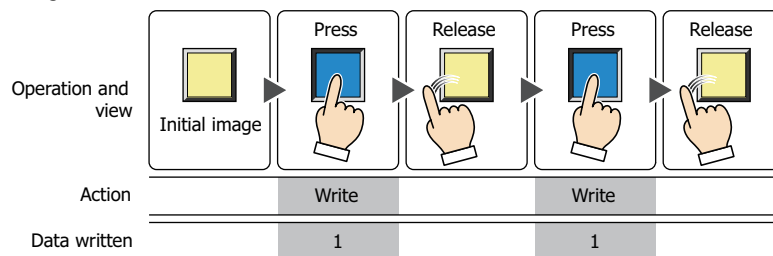

Reset: Pressing the button writes a 0 to the bit device.

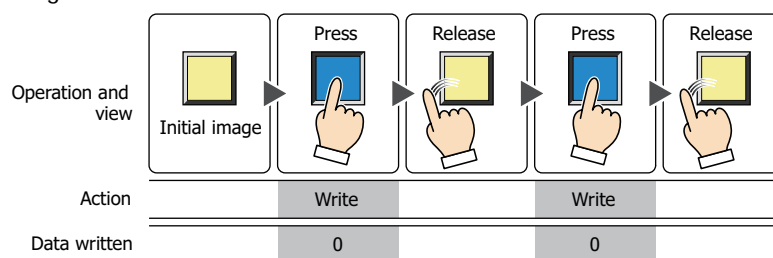

Momentary: Pressing the button writes a 1 to the bit device.
Releasing the button writes a 0 to the bit device.

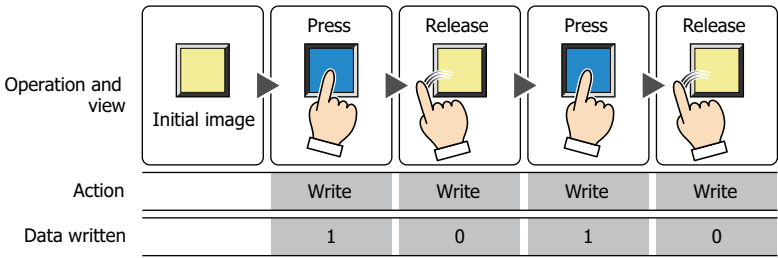

Pressing and holding the button until the screen changes causes a 0 to be written to the bit device.

Alternate: Each press of the button alternately writes a 1 or 0 to the bit device.

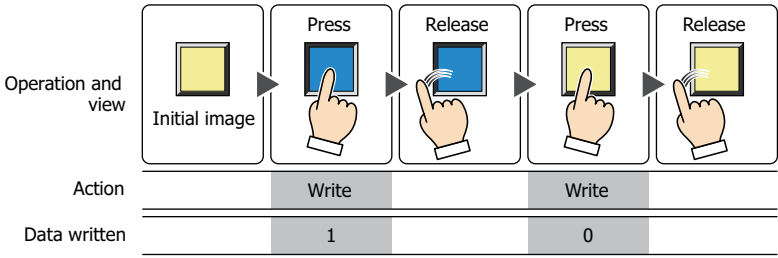

Toggle: Pressing the button inverts the value of the bit device.
If the value of the bit device is 0 it changes to 1, and vice versa.

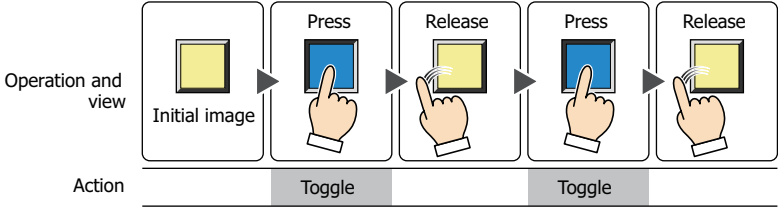

Move: Pressing the button writes the value in the source bit device to the value in the destination bit device.

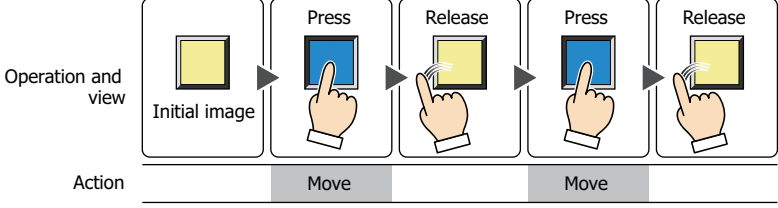

■ Destination Device

Specify the destination bit device.

Click  to display the Device Address Settings dialog box. For the device address configuration procedure, refer to Chapter 2 "5.1 Device Address Settings" on page 2-61.

■ **Write**^{*1}

Specify the number of bit devices (1 to 64) at the destination.

This setting is enabled only if **Action Mode** is set to **Set** or **Reset**.

Example: This fills a contiguous block of bit devices with the same value.

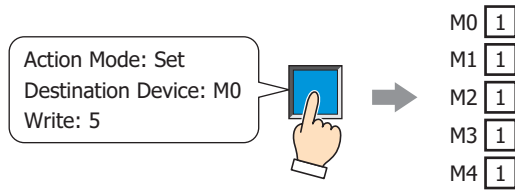

If the bit in a word device is specified, the same value is written to same bit of contiguous word devices.

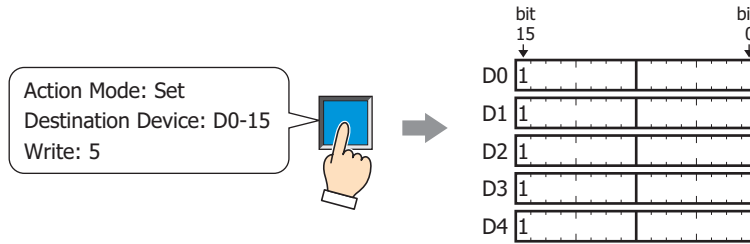

■ **Source Data**

Specifies the device that stores the data to be written.

This setting is enabled only if **Action Mode** is set to **Move**.

Device: Specify the source bit device.

Click to display the Device Address Settings dialog box. For the device address configuration procedure, refer to Chapter 2 “5.1 Device Address Settings” on page 2-61.

Transfer: Specify the number of bit devices (1 to 64) to transfer.

Example: This button writes the values in a contiguous block of bit devices to a contiguous block of devices at the destination.

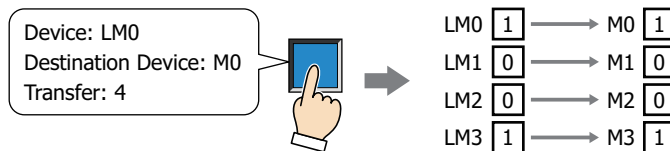

*1 Advanced mode only

■ View Switching Method*1

Select how to display the ON/OFF status of the button.

Button: Pressing the button changes the drawing object displayed.

Device: The drawing objects assigned to the OFF and ON states are displayed when the value of device is 0 and 1, respectively. Specifies the device used to switch the drawing object display.

Click  to display the Device Address Settings dialog box. For the device address configuration procedure, refer to Chapter 2 "5.1 Device Address Settings" on page 2-61.

No Image: The button is not displayed on the screen. The button appears as a dashed line frame on the edit screen. Pressing the corresponding area on the Touch activates the assigned function. If **No Image** is selected, the settings for **View** and **Registration Text** are disabled.



Selecting **Device** in **View Switching Method** allows you to create an illuminated pushbutton.

The illuminated pushbutton switches state (or image) according to ON or OFF state of the device address, allowing you to display the state of a device that is being operated.

Example: When you set an external device address M0 as **Device** in **View Switching Method**, if the value of M0 changes, the display image will switch according to the value of M0 even if the button is not pressed.

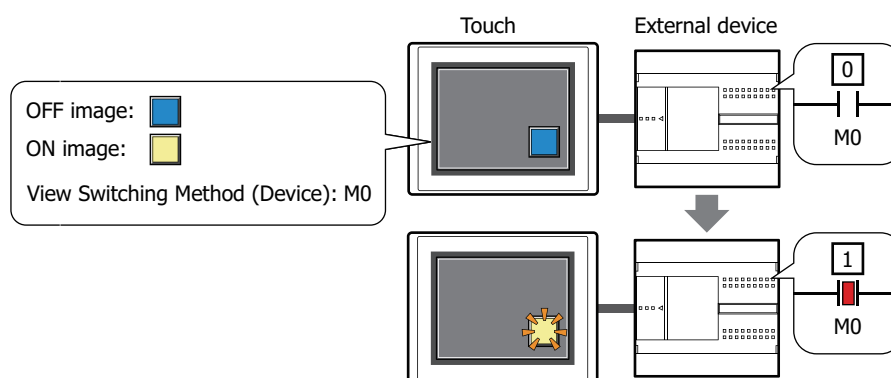

*1 Advanced mode only

● View Tab

Only **Coordinates** and **Size** can be configured when **No Image** is selected for **View Switching Method** on the **General** tab.

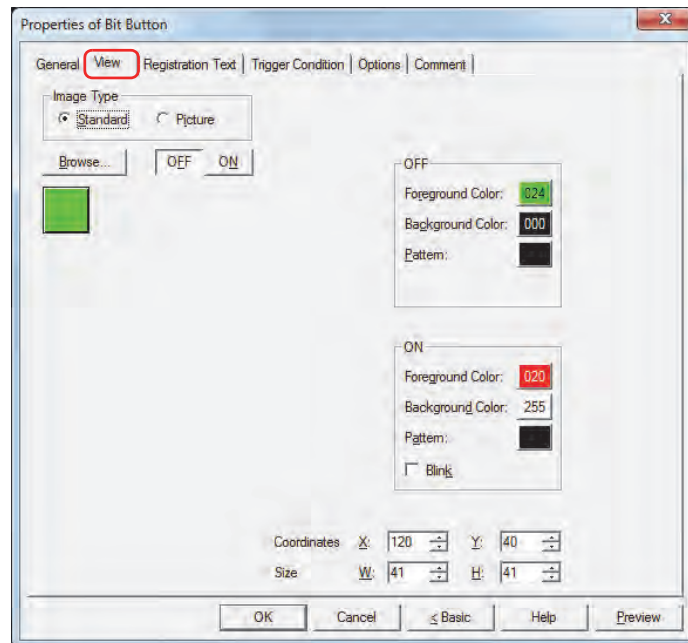

■ Image Type

Select the type of graphic to be used to represent the part.

Standard: Uses the default graphics contained within WindO/I-NV3.

Picture: Uses an image file saved in Picture Manager.

For details about image file restrictions, refer to Chapter 2 “1.4 Available Image Files” on page 2-18.

■ Browse

Select the type of graphic to be used to represent the part from the list of graphics. Click this button to display the View Browser or Picture Manager, depending on the setting for **Image Type**.

■ OFF button, ON button

Displays the graphic when ON or OFF. Clicking the **ON** button or **OFF** button switches the image displayed on the **View** tab.

■ OFF, ON

Selects the color and pattern of the standard graphic when ON and OFF.

Foreground Color, Background Color:

Selects the foreground and background colors of the standard graphic (color: 256 colors, monochrome: 8 shades).

Click the **Color** button to display the Color Palette. Select a color from the Color Palette.

Pattern: Selects a pattern for the standard graphic.

Click the **Pattern** button to display the Pattern Palette. Select a pattern from the Pattern Palette.

■ Blink

Select this check box if blinking is desired (alternating ON and OFF) when a part is ON.

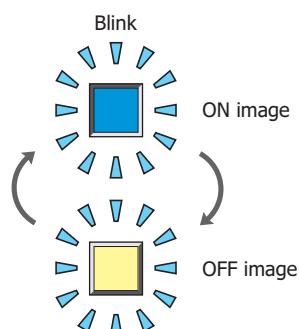

■ Coordinates

- X, Y: Sets the display position of parts using coordinates.
 The X and Y coordinates of parts are defined relative to an origin at the top-left corner of the screen.
- X: 0 to (Base Screen horizontal size - 1)
- Y: 0 to (Base Screen vertical size - 1)

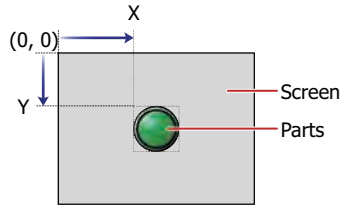

■ Size

- W, H: Sets width and height to define the size of parts.
- W: 20 to (Base Screen horizontal size)
- H: 20 to (Base Screen vertical size)

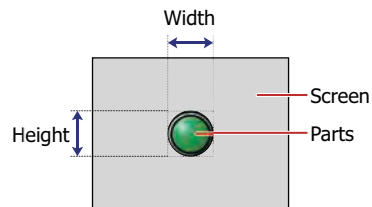

● Registration Text Tab

These options can only be configured when **Button** or **Device** is selected for **View Switching Method** on the **General** tab.

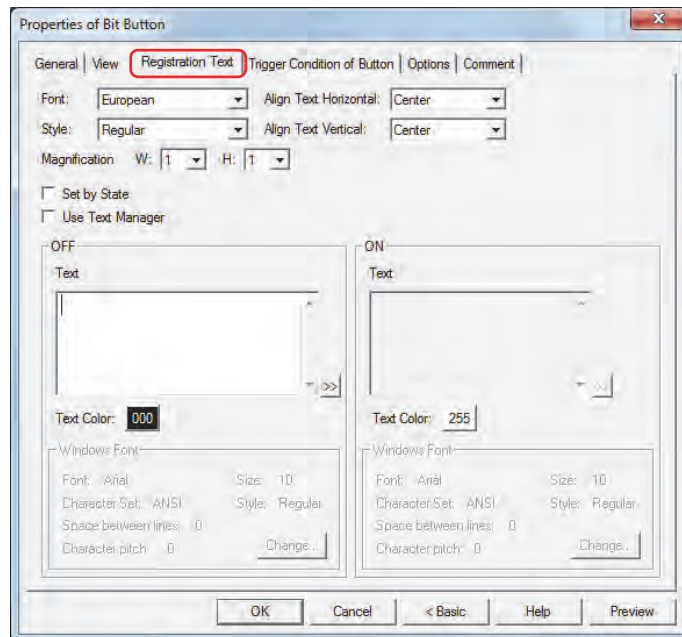

■ Font

Selects the font used for displaying text from the following.

Japanese, European, Chinese, Taiwanese, Korean, Central European, Baltic, Cyrillic, Windows

Can only be set when the **Use Text Manager** check box is cleared.

The characters that can be displayed depend on the font. For details, refer to Chapter 2 "1.2 Available Text" on page 2-5.

■ Style

Selects **Regular** or **Bold** for text style.

Can only be set when **Font** is set to **Japanese, European, Chinese, Taiwanese, Korean, Central European, Baltic** or **Cyrillic**.

■ Magnification

W, H: Selects the magnification (0.5, 1 to 8) for text display.

Can only be set when **Font** is set to **Japanese, European, Chinese, Taiwanese, Korean, Central European, Baltic** or **Cyrillic**.

■ Align Text Vertical

Selects text alignment in the vertical direction.

Top, Center, Bottom

For details, refer to Appendix "5 Text Alignment" on page A-5.

■ Align Text Horizontal

Selects text alignment in the horizontal direction.

Left, Center, Right, Center-Left

For details, refer to Appendix "5 Text Alignment" on page A-5.

■ Set by State

Select this check box if displaying different text when ON and OFF.

■ Use Text Manager

Select this check box if using the text registered in Text Manager for text display.

■ OFF, ON

Text: Inputs characters to be displayed on parts. The maximum number is 3,750 characters.
The characters that can be entered depend on the font selected using **Font**. For details, refer to Chapter 2 "1.2 Available Text" on page 2-5.



When entering Unicode characters click  to display the Unicode Input dialog box. Enter the characters using the Unicode Input dialog box then click **OK**.

Text ID: Specifies the Text Manager ID No. (1 to 32000) when using the text registered in Text Manager.

Click  to display Text Manager.

Can only be set when the **Use Text Manager** check box is selected.

Text Color: Selects the color of the text displayed on the part (color: 256 colors, monochrome: 8 shades).

Click the **Color** button to display the Color Palette. Select a color from the Color Palette.

Windows Font: Sets the font to be used as the Windows Font.

Select **Windows** using **Font** to display the current setting. To change the setting, click **Change** to display the Font dialog box.

Can only be set when the **Use Text Manager** check box is cleared.

For details, refer to Chapter 2 "Windows Font" on page 2-12.

● **Trigger Condition Tab**

The **Trigger Condition** tab is displayed in Advanced mode.

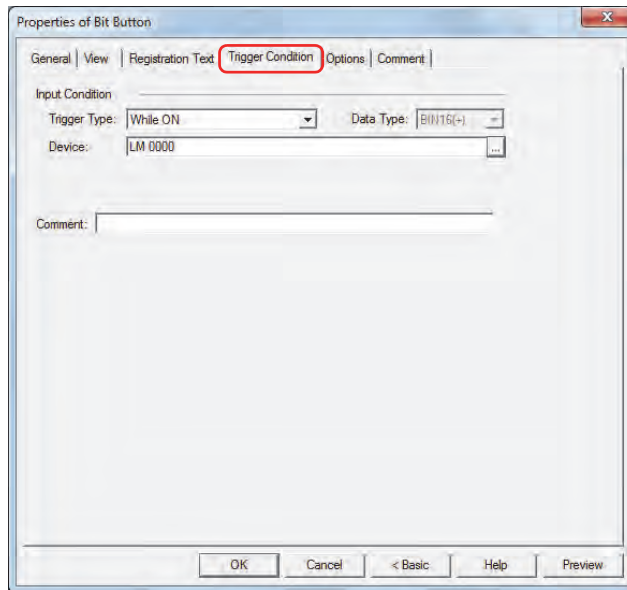

■ **Input Condition**

The Button is enabled and operational while the condition is satisfied. The Button is disabled and not operational while the condition is not satisfied.

Example: When **Trigger Type** is **While ON** and **Device** is LM0

While LM0 is 0, the condition is not satisfied and the Button is not operational.

While LM0 is 1, the condition is satisfied and the Button is operational.

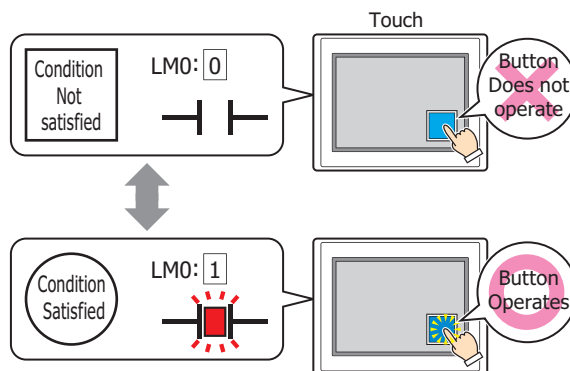

Trigger Type: Selects the condition to enable the Button from the following.

Always Enabled: The Button is always enabled.



While ON: Enables the Button when the value of device is 1.

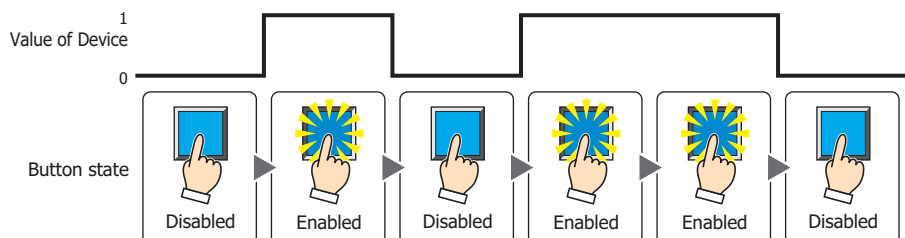

While OFF: Enables the Button when the value of device is 0.

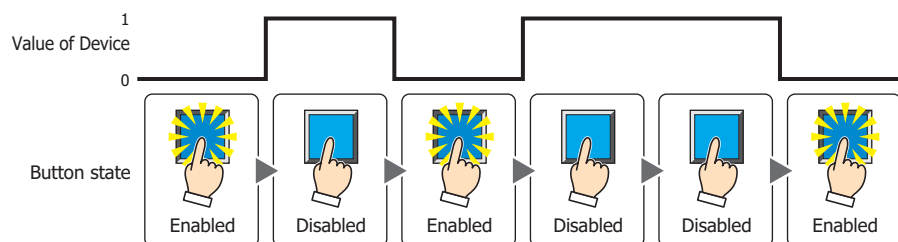

While satisfying the condition:

Enables the Button when the condition is satisfied.

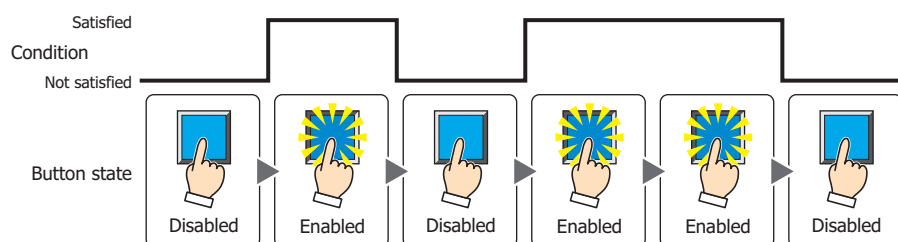

- Data Type:** Selects the type of data handled by the conditional expression for the input condition. This option can only be configured if **While satisfying the condition** is selected for **Trigger Type**. For details, refer to Chapter 2 "1.1 Available Data" on page 2-1.
- Device:** Specifies the bit device or bit of the word device to serve as the input condition. This option can only be configured when **While ON** or **While OFF** is selected for **Trigger Type**. Click to display the Device Address Settings dialog box. For the device address configuration procedure, refer to Chapter 2 "5.1 Device Address Settings" on page 2-61.
- Condition:** Specifies the conditional expression for the input condition. This option can only be configured when **While satisfying the condition** is selected for **Trigger Type**. Click to display the Trigger Condition Settings dialog box. For the conditional expression configuration procedure, refer to Chapter 2 "5.2 Setting Conditional Expressions" on page 2-63.
- Comment:** Enter a comment for the input condition. The maximum number is 80 characters.

● Options Tab

The **Options** tab is displayed in Advanced mode.

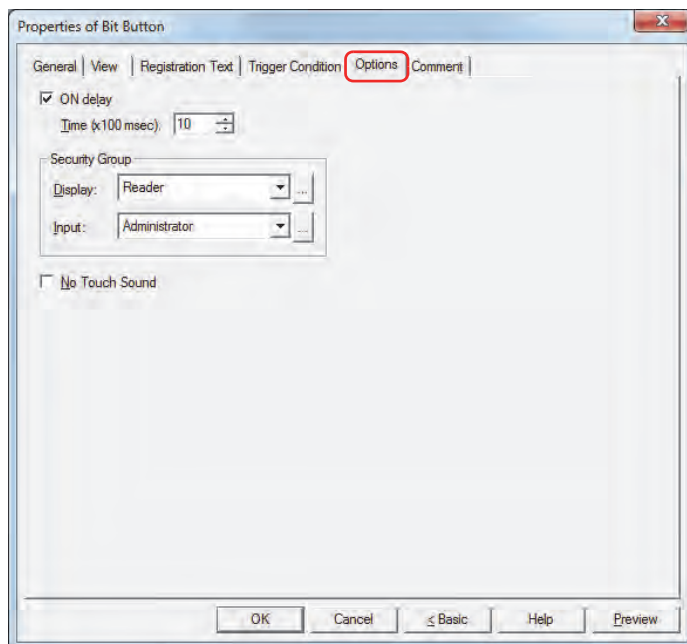

■ ON delay

Select this check box to use the ON delay function.

Time (x100 msec): Specify the length of time that the button must be held down before activation by selecting a value from 0 to 600 (units of 10 milliseconds).

The button activates after it is held down for a specified period of time.

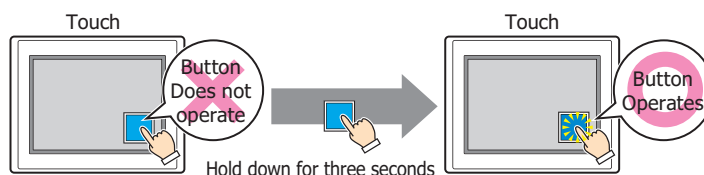

This feature protects against mistaken operation by ensuring that the button will not be activated if touched accidentally.

■ Security Group

Security groups are a security function for restricting the display and operation of parts.

Display: Selects the security group for which display of parts is restricted. (Default: None)

None: No security function is used.

Administrator, Operator, Reader: Three security groups are set up by default.

Click to display the Security Group Settings dialog box. If you create a security group on the Security Group Settings dialog box, you can select that created group. For details, refer to Chapter 21 "2.2 Adding and Editing Security Groups" on page 21-15.

Input: Selects the security group for which operation of parts is restricted. (Default: None)

None: No security function is used.



Administrator, Operator, Reader: Three security groups are set up by default.

Click to display the Security Group Settings dialog box. If you create a security group on the Security Group Settings dialog box, you can select that created group. For details, refer to Chapter 21 "2.2 Adding and Editing Security Groups" on page 21-15.



For details about security functions, refer to Chapter 21 "User Accounts and the Security Function" on page 21-1.

Example: If the user and security group for a part are set as follows:

User Name	 User1	 User2	 User3
Security Group	None	Group A	Group A, Group B

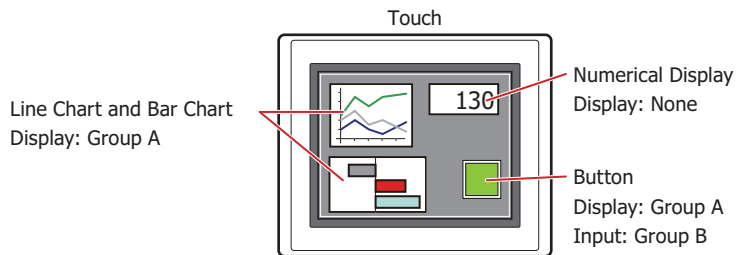

For User1, who is not included in the specified security group, Group A parts are not displayed. If the Password Screen is now opened and User2 logs in, Group A parts are displayed.

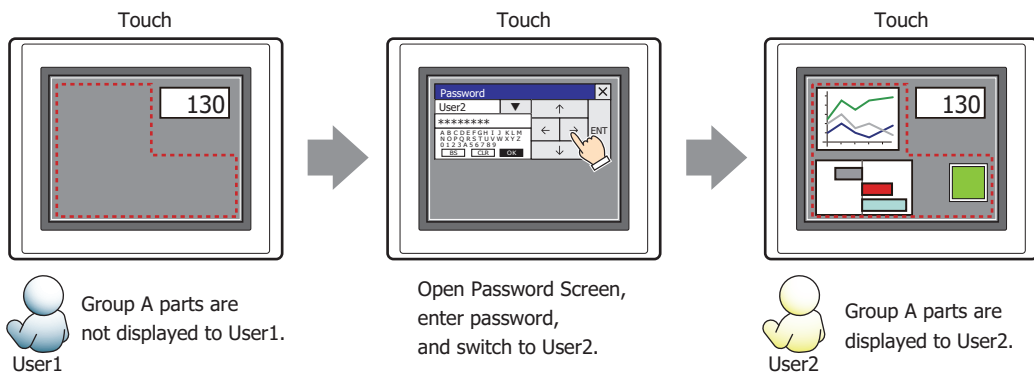

Since the display security group is Group A, User2 can view the buttons. But since the input security group is Group B, User2 cannot operate the buttons.

Suppose that the Password Screen is now opened and User3 logs in to the system. Group A buttons can be displayed, and Group B buttons can be operated.

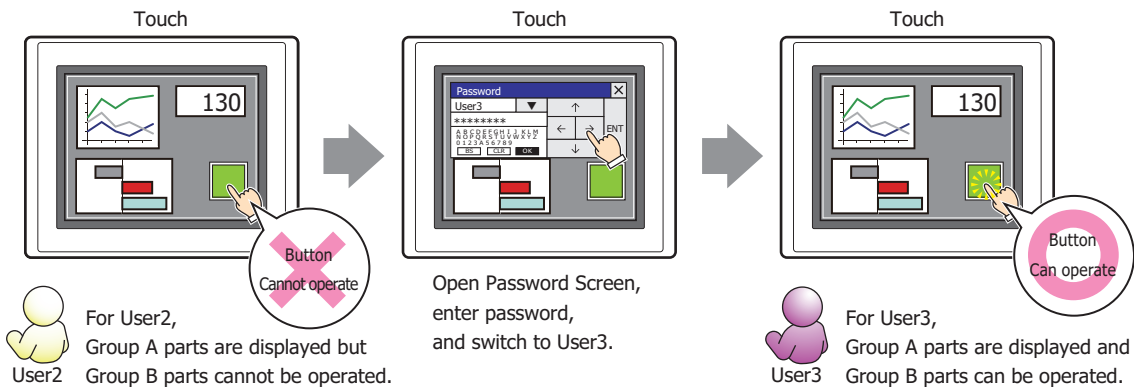

■ **No Touch Sound**

This function is to disable touch sounds only for specified parts when the Touch makes touch sounds. Select this check box to display disable touch sounds for this part.



To enable touch sounds on the Touch, select the **Enable Touch Sound** check box under the **System** tab of the Project Settings dialog box.

● Comment Tab

The **Comment** tab is used to specify the parts arranged on the editing screen, and the popup text displayed when the mouse pointer is placed close to **No.**, **Name**, or **Type** in the object list.



When there are multiple parts of the same shape on the screen, this feature makes it possible to distinguish between the parts without displaying the Properties dialog box for each part, by just mousing over the part.

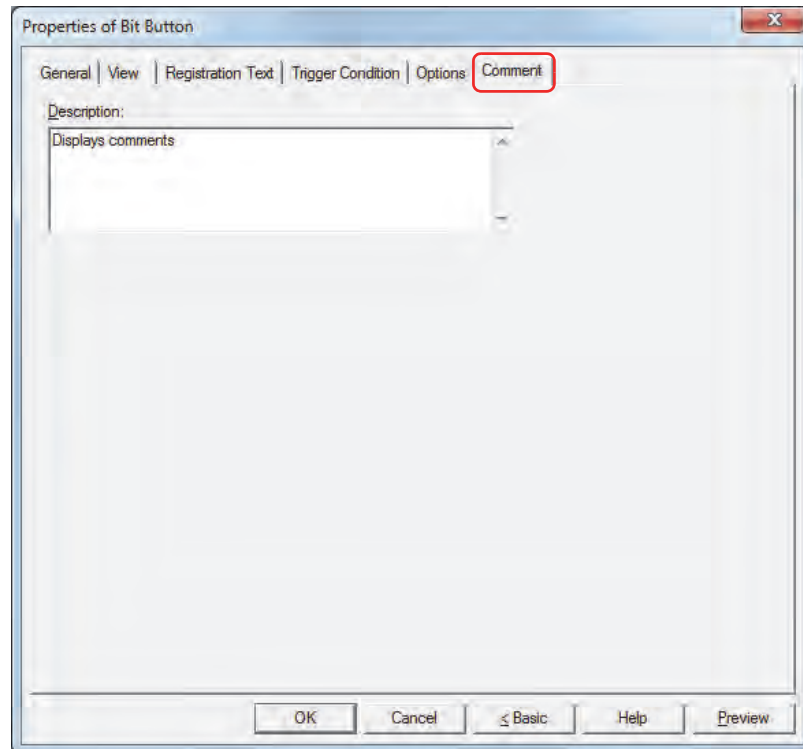

■ Description

Enter a comment comments about parts. The maximum number is 80 characters.

Example: When mousing over the Button on the editing screen

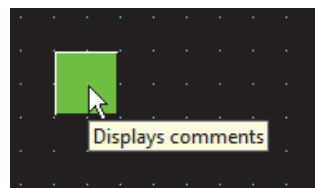

2 Word Button

2.1 How the Word Button is Used

Writes a value to a word device. Can be used to indirectly specify the destination address or to perform operations on the written value.

- Pressing the button writes a constant value to a word device.

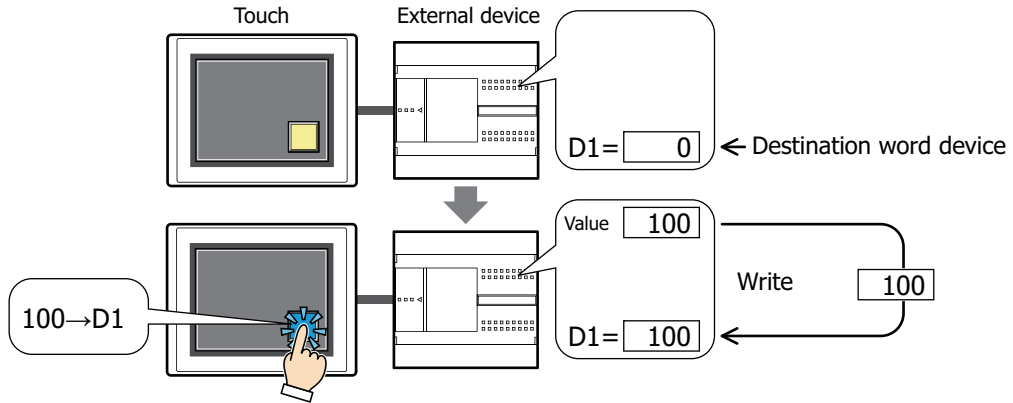

- Pressing the button writes the value of device address to a word device.

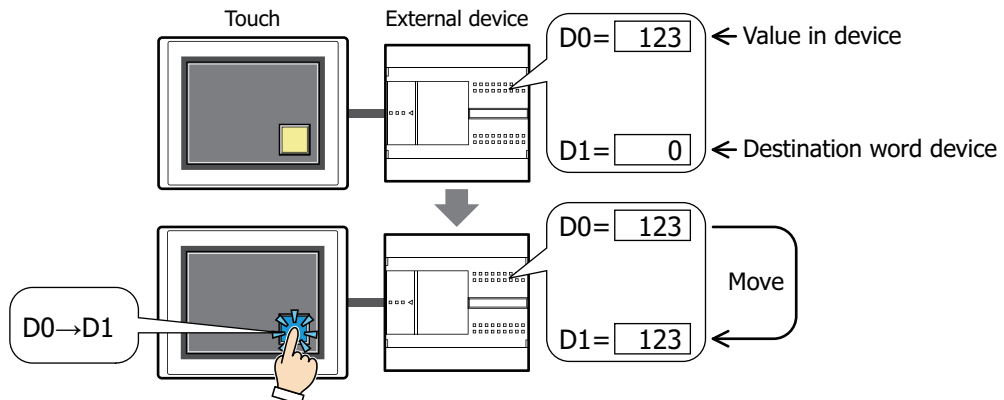

- Pressing the button performs arithmetic on the value to write before writing it to a word device.

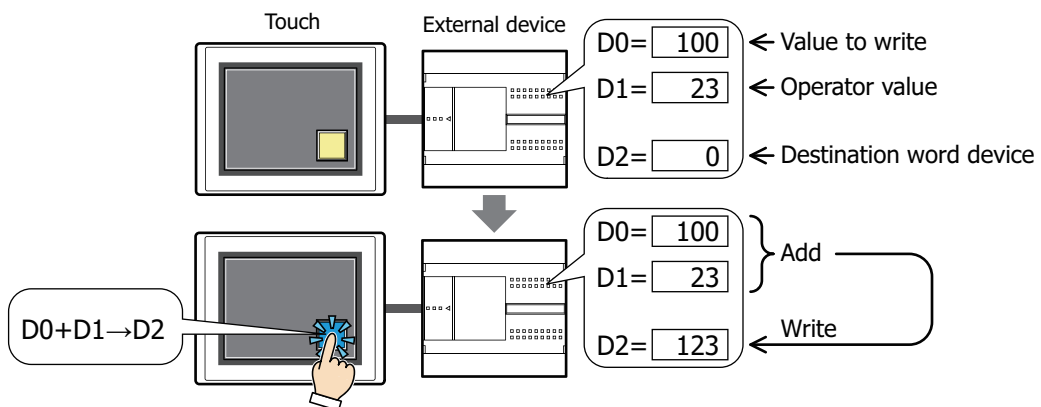

■ **Set**

Pressing the button writes a constant value to a word device.

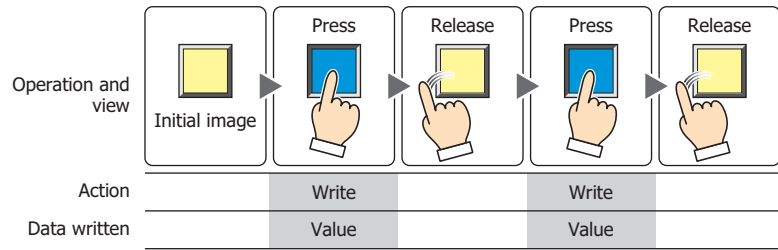

■ **Move**

Pressing the button writes the value in the source device to the destination word device.

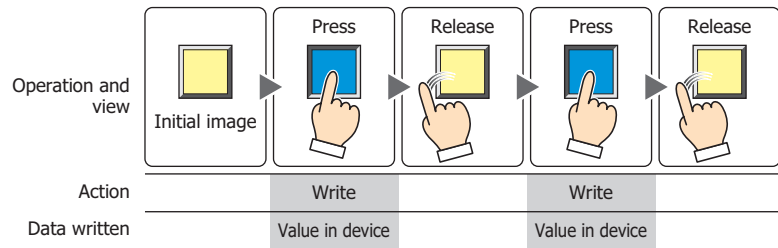

■ **Momentary**

Pressing the button writes the constant value of ON data to a word device.

Releasing the button writes the constant value of OFF data to a word device.

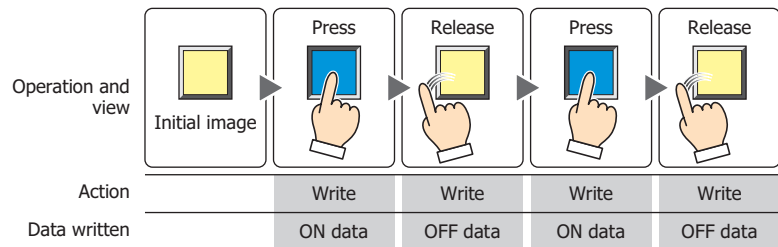

Pressing and holding the button until the screen changes causes the OFF data to be written to the word device.

■ **Alternate**

Each press of the button alternately writes the fixed value of ON data and OFF data to the word device.

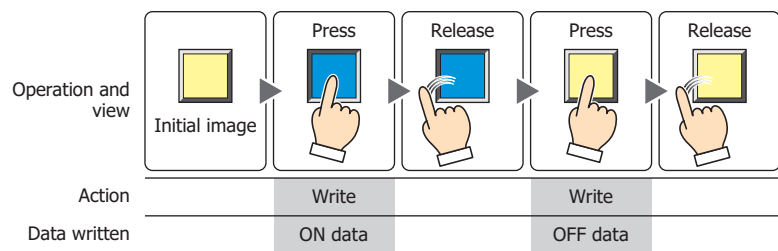

■ **Add, Sub, Multi, Div, Mod, OR, AND, XOR**

Pressing the button performs arithmetic on the value in a reference device and a constant value or the value in a device address and writes the result to a word device.

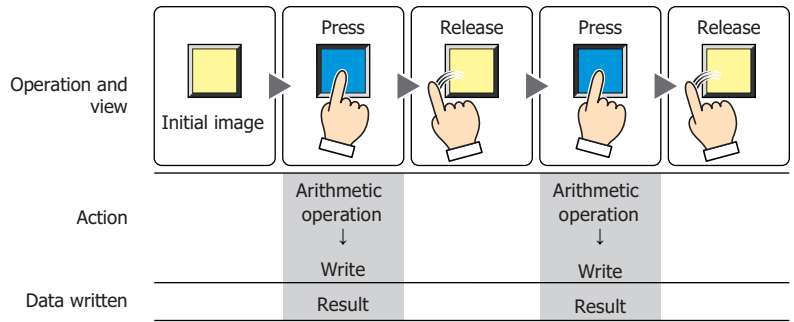

Example: Add (Addition)

Pressing the button adds the value in the **Source 1** to the **Source 2** value and writes the sum in the word device.

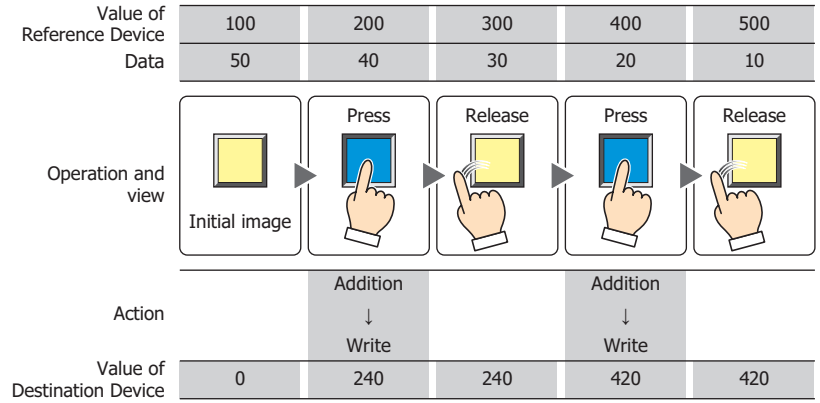

2.2 Word Button Configuration Procedure

This section describes the configuration procedure for Word Buttons.

- 1 On the **Home** tab, in the **Parts** group, click **Buttons**, and then click **Word Button**.

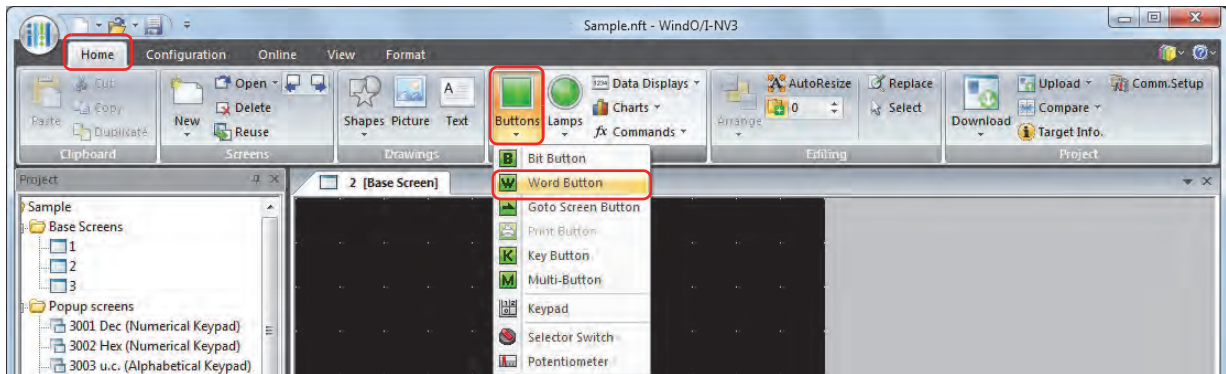

- 2 Click a point on the edit screen where you want to place the Word Button.
- 3 Double-click the dropped Word Button and a Properties dialog box will be displayed.
- 4 Change the settings on each tab as necessary.

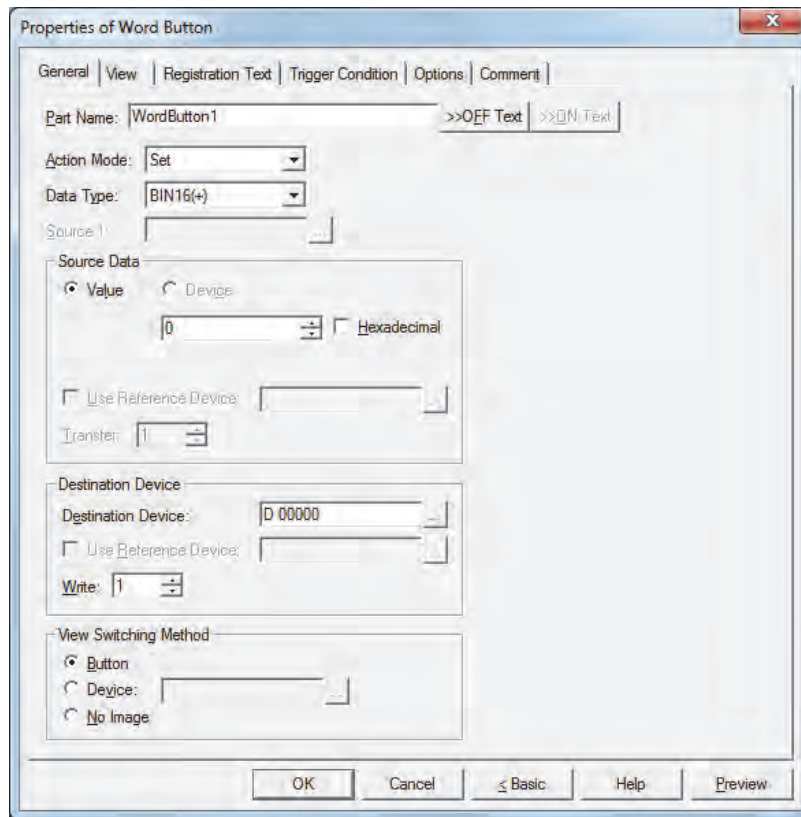

The **Trigger Condition** tab and **Options** tab only appear in Advanced mode. To switch to Advanced mode, click **Advanced**.

2.3 Properties of Word Button Dialog Box

This section describes items and buttons in the Properties dialog box.

● General Tab

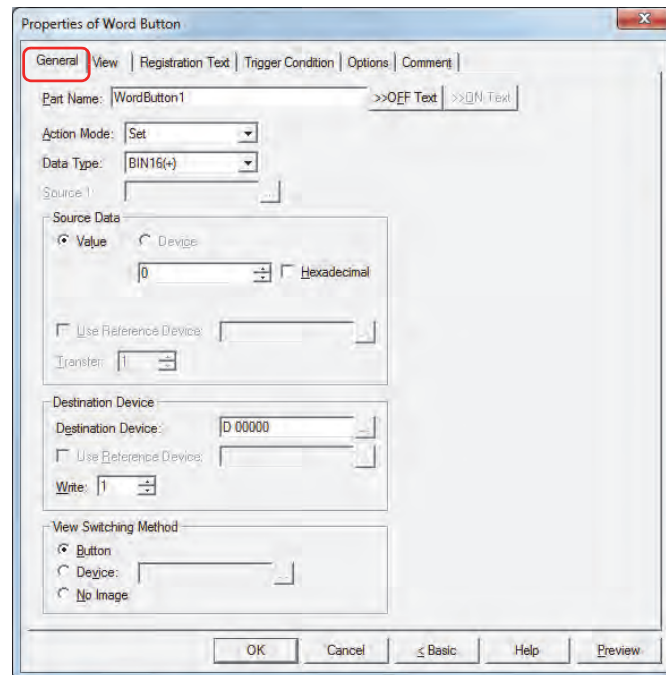

■ Part Name

Enter a name for the part. The maximum number is 20 characters.

■ >>OFF Text, >>ON Text

Applies the text entered in the **Part Name** field to the **Text** field under the **OFF** or **ON** fields on the **Registration Text** tab. This is used as the Registration Text when the button is OFF or ON.



To specify the Registration Text to use when the button is ON, select the **Set by State** check box on the **Registration Text** tab. If left unchecked, the same Registration Text assigned for the OFF state is displayed for the ON state as well.

■ Action Mode

Select the behavior of the button from the following:

Set: Pressing the button writes a constant value to a word device.

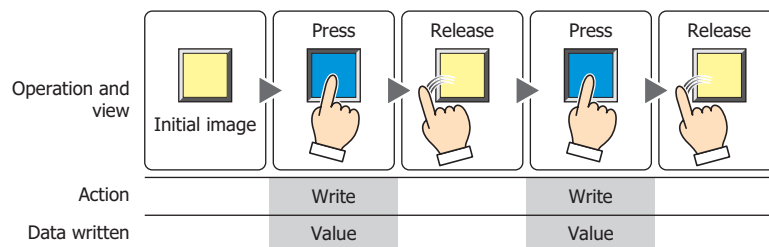

Move: Pressing the button writes the value in the source device to the destination word device.

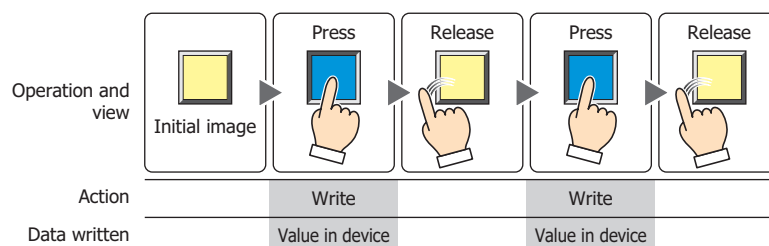

Momentary: Pressing the button writes the constant value of ON data to a word device.
 Releasing the button writes the constant value of OFF data to a word device.

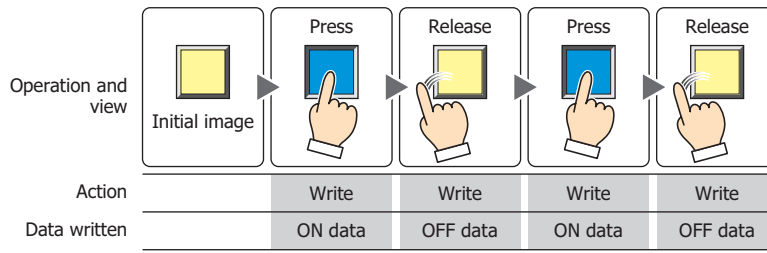

Pressing and holding the button until the screen changes causes the OFF data to be written to the word device.

Alternate: Each press of the button alternately writes the fixed value of ON data and OFF data to the word device.

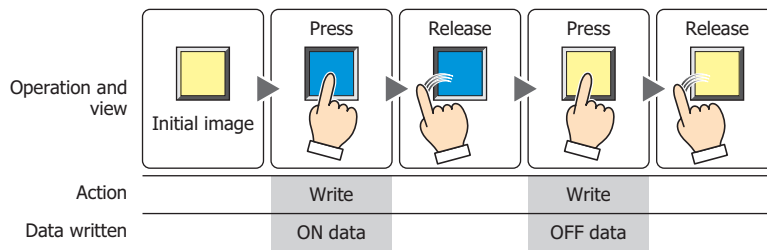

Add, Sub, Multi, Div, Mod, OR, AND, XOR:

Pressing the button performs arithmetic on the value in a reference device and a constant value or the value in a device address and writes the result to a word device.

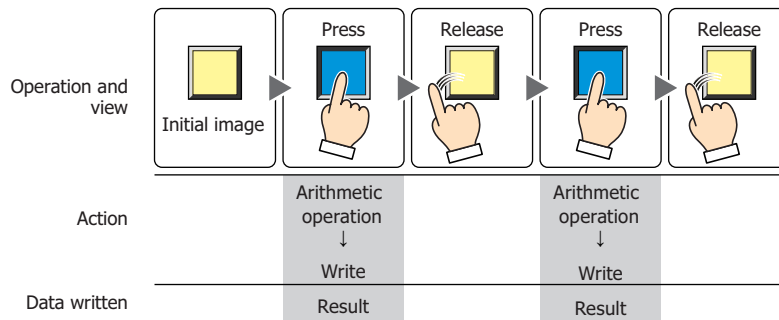

Example: Add (Addition)

Pressing the button adds the value in the **Source 1** to the **Source 2** value and writes the sum in the word device.

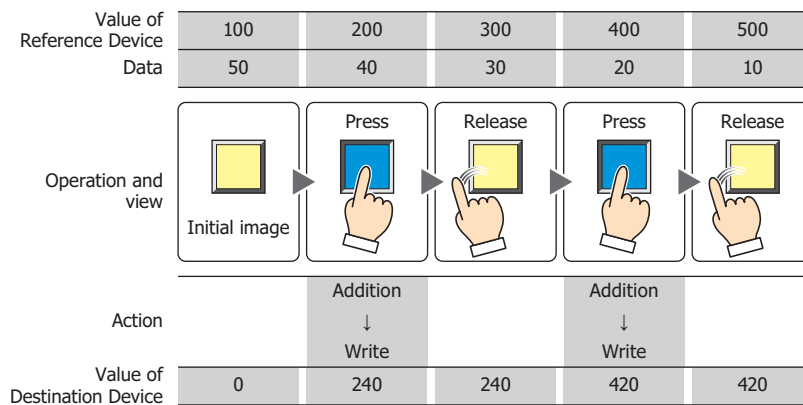

■ Data Type

Select the data type handled by the operation selected for **Action Mode**.

For details, refer to Chapter 2 "1.1 Available Data" on page 2-1.

BIN16(+) and **BIN32(+)** can only be set if **Action Mode** is set to **OR**, **AND**, or **XOR**.



BIN16(+) and **BIN32(+)** can only be set if **Action Mode** is set to **Move**. Because the number of devices to transfer is specified in Advanced mode, you do not need to set Data Type.



If **BCD4**, **BCD8** or **float32** is selected and the arithmetic data contains a value inexpressible in BCD, a 1 is written to System Area 2 Arithmetic error bit (address+2, bit 5) and an error message is displayed.

For details, refer to Chapter 3 "Arithmetic error" on page 3-25.

■ Source 1

Specify the source word device.

Click  to display the Device Address Settings dialog box. For the device address configuration procedure, refer to Chapter 2 "5.1 Device Address Settings" on page 2-61.

This setting is enabled only if **Action Mode** is set to **Add**, **Sub**, **Multi**, **Div**, **Mod**, **OR**, **AND**, or **XOR**.

■ Source Data

Select the data handled by the operation selected for **Action Mode**.

Value: Use a constant.

Only a **Value** can be handled if **Action Mode** is set to **Set**, **Momentary**, or **Alternate**.

If **Action Mode** is set to **Momentary** or **Alternate**, the value in the **ON Data** is written when the button is ON, and the value in the **OFF Data** is written when the button is OFF.

Hexadecimal: Select this check box to enter the **ON Data** and **OFF Data** values in hexadecimal.

Device: Use a word device.

Specify the device.

Click  to display the Device Address Settings dialog box. For the device address configuration procedure, refer to Chapter 2 "5.1 Device Address Settings" on page 2-61.

Use Reference Device^{*1}: Select this check box and specify a device to change the source word device according to the value of the specified device.

This setting is enabled only if **Action Mode** is set to **Move**.

For details, refer to Chapter 2 "Indirect Read and Indirect Write Settings" on page 2-4.

Transfer¹:

Specify the number of word devices (1 to 64) to transfer.

This setting is enabled only if **Action Mode** is set to **Move**.

Example: If **Transfer** is set to **2** and **Write** is set to **3**, the same data in 2 continuous word devices will be written to the destination device 3 times.

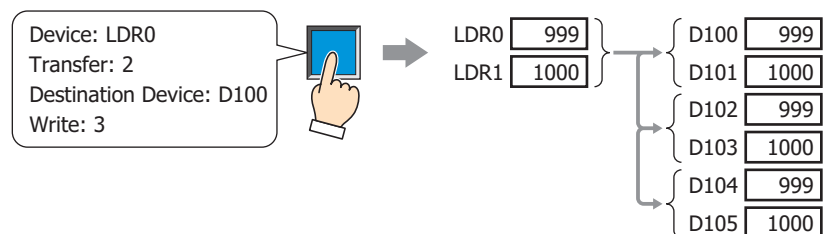

*1 Advanced mode only

■ **Destination Device**

Destination Device: Specify the destination word device.

Click  to display the Device Address Settings dialog box. For the device address configuration procedure, refer to Chapter 2 "5.1 Device Address Settings" on page 2-61.

Use Reference Device^{*1}: Select this check box and specify a device to change the destination word device according to the value of the specified device.

This setting is enabled only if **Action Mode** is set to **Move**.

For details, refer to Chapter 2 "Indirect Read and Indirect Write Settings" on page 2-4.

Write ¹: Specify the number of word devices (1 to 64) at the destination.

For **Move**, specify how many times to write.

This setting is enabled only if **Action Mode** is set to **Set, Momentary, Alternate, or Move**.

Example: If **Data Type** is set to **BIN16(+)** and **Write** is set to 5, the same data will be written to 5 continuous word addresses.

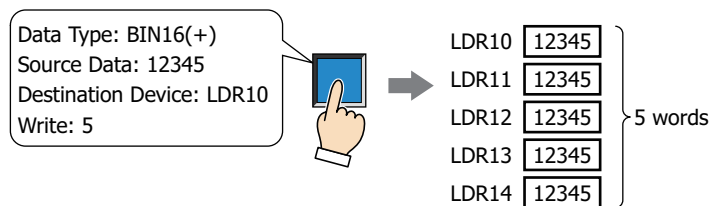

Example: If **Data Type** is set to **BIN32(+)** and **Write** is set to 5, the same data will be written to a total of 10 word addresses (2 words 5 times).

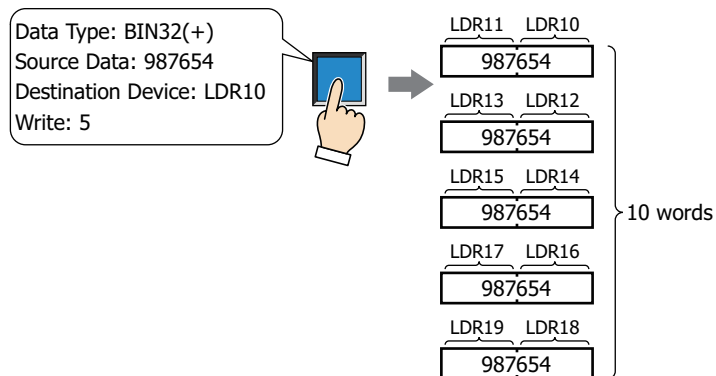

*1 Advanced mode only

■ View Switching Method*1

Select how to display the ON/OFF status of the button.

Button: Pressing the button changes the drawing object displayed.

Device: The drawing objects assigned to the OFF and ON states are displayed when the value of device is 0 and 1, respectively. Specifies the device used to switch the drawing object display.

Click  to display the Device Address Settings dialog box. For the device address configuration procedure, refer to Chapter 2 "5.1 Device Address Settings" on page 2-61.

No Image: The button is not displayed on the screen. The button appears as a dashed line frame on the edit screen. Pressing the corresponding area on the Touch activates the assigned function. If **No Image** is selected, the settings for **View** and **Registration Text** are disabled.



Selecting **Device** in **View Switching Method** allows you to create an illuminated pushbutton.

The illuminated pushbutton switches state (or image) according to ON or OFF state of the device address, allowing you to display the state of a device that is being operated.

Example: When you set an external device address M0 as **Device** in **View Switching Method**, if the value of M0 changes, the display image will be switched according to the value of M0 even if the button is not pressed.

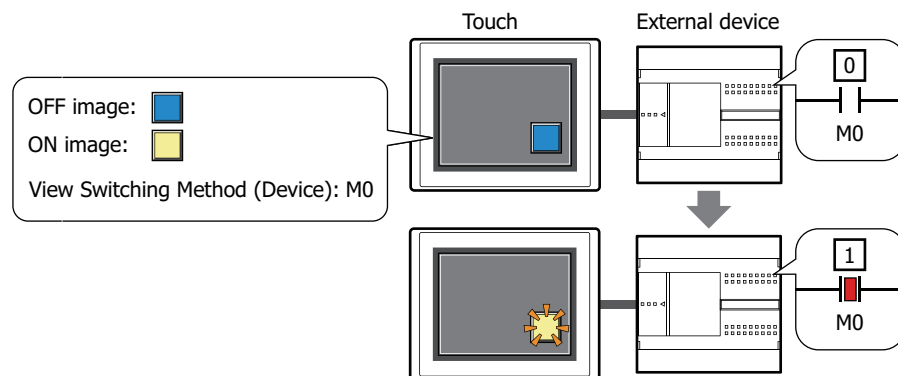

*1 Advanced mode only

● View Tab

Only **Coordinates** and **Size** can be configured when **No Image** is selected for **View Switching Method** on the **General** tab.

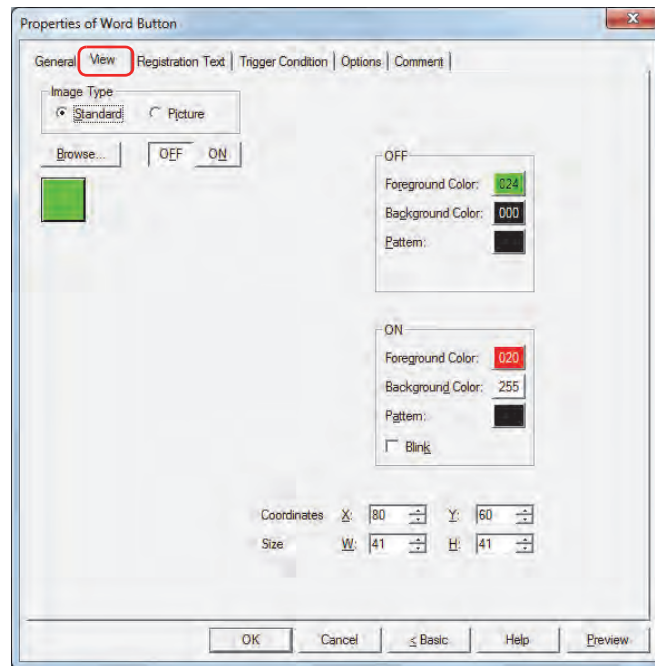

■ Image Type

Select the type of graphic to be used to represent the part.

Standard: Uses the default graphics contained within WindO/I-NV3.

Picture: Uses an image file saved in Picture Manager.

For details about image file restrictions, refer to Chapter 2 "1.4 Available Image Files" on page 2-18.

■ Browse

Select the type of graphic to be used to represent the part from the list of graphics. Click this button to display the View Browser or Picture Manager, depending on the setting for **Image Type**.

■ OFF button, ON button

Displays the graphic when ON or OFF. Clicking the **ON** button or **OFF** button switches the image displayed on the **View** tab.

■ OFF, ON

Selects the color and pattern of the standard graphic when ON and OFF.

Foreground Color, Background Color:

Selects the foreground and background colors of the standard graphic (color: 256 colors, monochrome: 8 shades).

Click the **Color** button to display the Color Palette. Select a color from the Color Palette.

Pattern:

Selects a pattern for the standard graphic.

Click the **Pattern** button to display the Pattern Palette. Select a pattern from the Pattern Palette.

■ Blink

Select this check box if blinking is desired (alternating ON and OFF) when a part is ON.

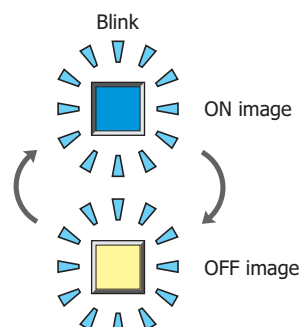

■ Coordinates

- X, Y: Sets the display position of parts using coordinates.
 The X and Y coordinates of parts are defined relative to an origin at the top-left corner of the screen.
- X: 0 to (Base Screen horizontal size - 1)
- Y: 0 to (Base Screen vertical size - 1)

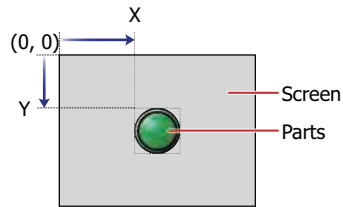

■ Size

- W, H: Sets width and height to define the size of parts.
- W: 20 to (Base Screen horizontal size)
- H: 20 to (Base Screen vertical size)

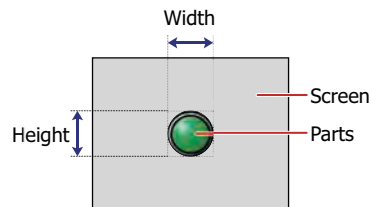

● Registration Text Tab

These options can only be configured when **Button** or **Device** is selected for **View Switching Method** on the **General** tab.

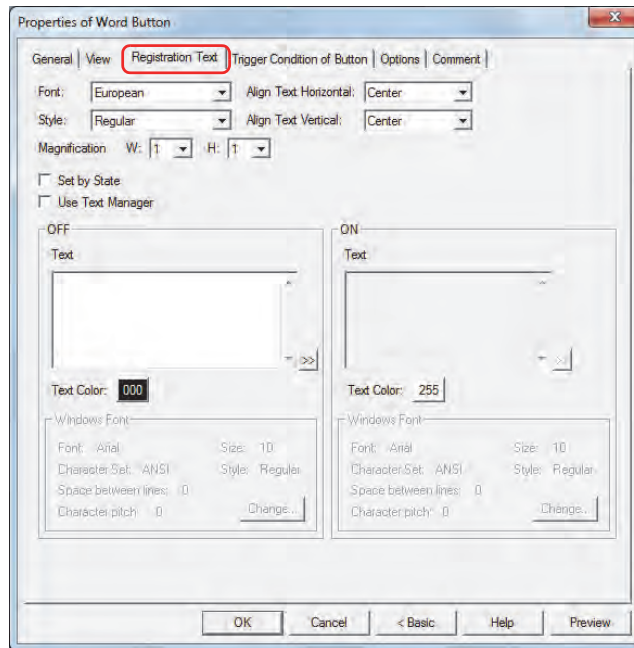

■ Font

Selects the font used for displaying text from the following.

Japanese, European, Chinese, Taiwanese, Korean, Central European, Baltic, Cyrillic, Windows

Can only be set when the **Use Text Manager** check box is cleared.

The characters that can be displayed depend on the font. For details, refer to Chapter 2 "1.2 Available Text" on page 2-5.

■ Style

Selects **Regular** or **Bold** for text style.

Can only be set when **Font** is set to **Japanese, European, Chinese, Taiwanese, Korean, Central European, Baltic** or **Cyrillic**.

■ Magnification

W, H: Selects the magnification (0.5, 1 to 8) for text display.

Can only be set when **Font** is set to **Japanese, European, Chinese, Taiwanese, Korean, Central European, Baltic** or **Cyrillic**.

■ Align Text Vertical

Selects text alignment in the vertical direction.

Top, Center, Bottom

For details, refer to Appendix "5 Text Alignment" on page A-5.

■ Align Text Horizontal

Selects text alignment in the horizontal direction.

Left, Center, Right, Center-Left

For details, refer to Appendix "5 Text Alignment" on page A-5.

■ Set by State

Select this check box if displaying different text when ON and OFF.

■ Use Text Manager

Select this check box if using the text registered in Text Manager for text display.

■ OFF, ON

Text: Inputs characters to be displayed on parts. The maximum number is 3,750 characters.
The characters that can be entered depend on the font selected using **Font**. For details, refer to Chapter 2 "1.2 Available Text" on page 2-5.



When entering Unicode characters click  to display the Unicode Input dialog box. Enter the characters using the Unicode Input dialog box then click **OK**.

Text ID: Specifies the Text Manager ID No. (1 to 32000) when using the text registered in Text Manager.

Click  to display Text Manager.

Can only be set when the **Use Text Manager** check box is selected.

Text Color: Selects the color of the text displayed on the part (color: 256 colors, monochrome: 8 shades).

Click the **Color** button to display the Color Palette. Select a color from the Color Palette.

Windows Font: Sets the font to be used as the Windows Font.

Select **Windows** using **Font** to display the current setting. To change the setting, click **Change** to display the Font dialog box.

Can only be set when the **Use Text Manager** check box is cleared.

For details, refer to Chapter 2 "Windows Font" on page 2-12.

● **Trigger Condition Tab**

The **Trigger Condition** tab is displayed in Advanced mode.

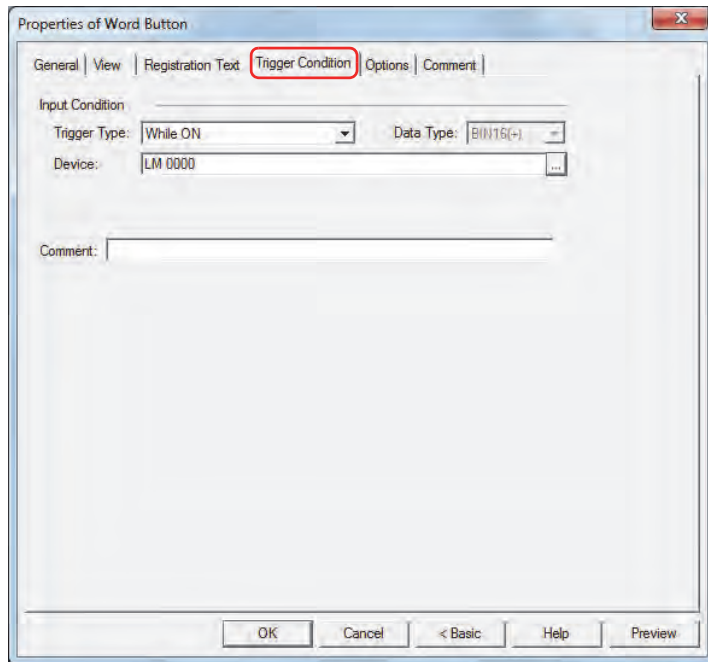

■ **Input Condition**

The Button is enabled and operational while the condition is satisfied. The Button is disabled and not operational while the condition is not satisfied.

Example: When **Trigger Type** is **While ON** and **Device** is LM0

While LM0 is 0, the condition is not satisfied and the Button is not operational.

While LM0 is 1, the condition is satisfied and the Button is operational.

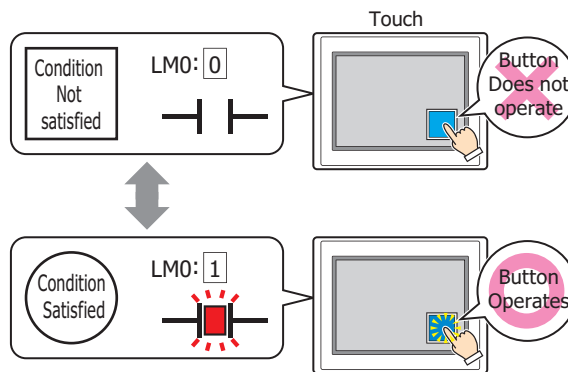

Trigger Type: Selects the condition to enable the Button from the following.

Always Enabled: The Button is always enabled.



While ON: Enables the Button when the value of device is 1.

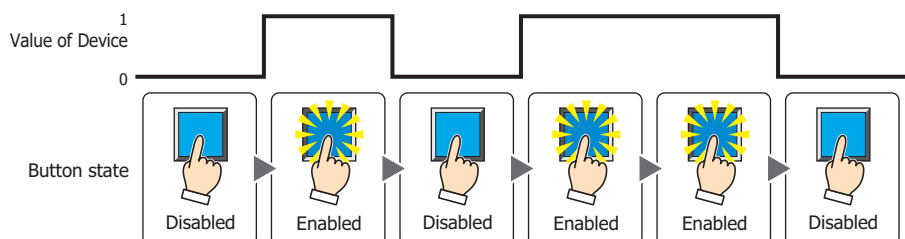

While OFF: Enables the Button when the value of device is 0.

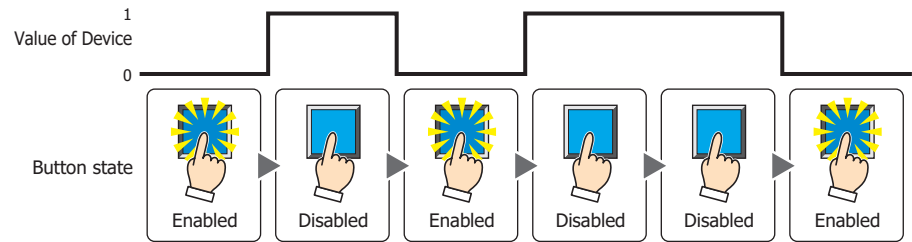

While satisfying the condition:

Enables the Button when the condition is satisfied.

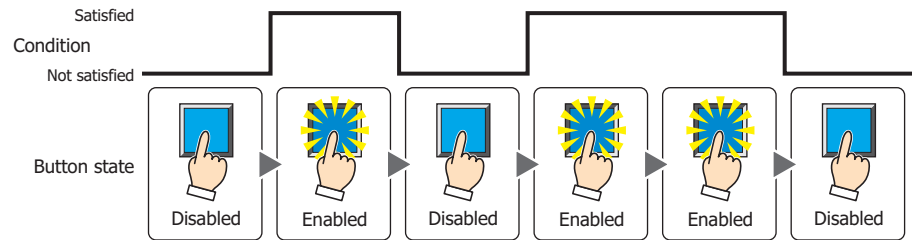

- Data Type:** Selects the type of data handled by the conditional expression for the input condition. This option can only be configured if **While satisfying the condition** is selected for **Trigger Type**. For details, refer to Chapter 2 “1.1 Available Data” on page 2-1.
- Device:** Specifies the bit device or bit of the word device to serve as the input condition. This option can only be configured when **While ON** or **While OFF** is selected for **Trigger Type**. Click to display the Device Address Settings dialog box. For the device address configuration procedure, refer to Chapter 2 “5.1 Device Address Settings” on page 2-61.
- Condition:** Specifies the conditional expression for the input condition. This option can only be configured when **While satisfying the condition** is selected for **Trigger Type**. Click to display the Trigger Condition Settings dialog box. For the conditional expression configuration procedure, refer to Chapter 2 “5.2 Setting Conditional Expressions” on page 2-63.
- Comment:** Enter a comment for the input condition. The maximum number is 80 characters.

● Options Tab

The **Options** tab is displayed in Advanced mode.

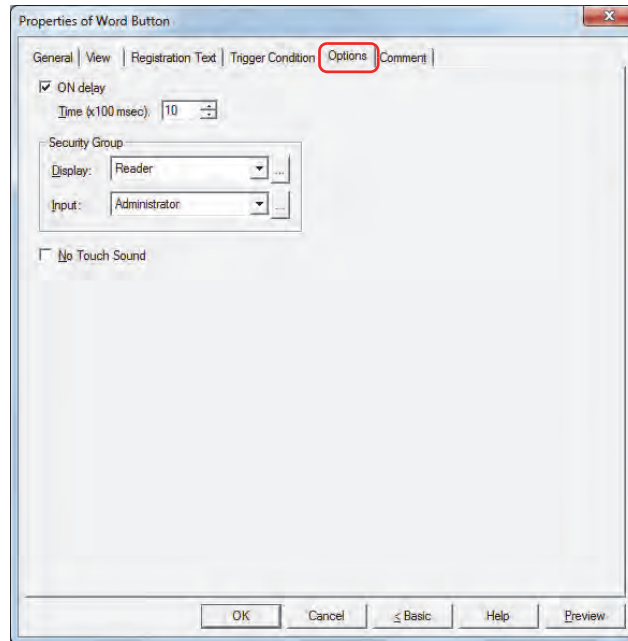

■ ON delay

Select this check box to use the ON delay function.

Time (x100 msec): Specify the length of time that the button must be held down before activation by selecting a value from 0 to 600 (units of 10 milliseconds).

The button activates after it is held down for a specified period of time.

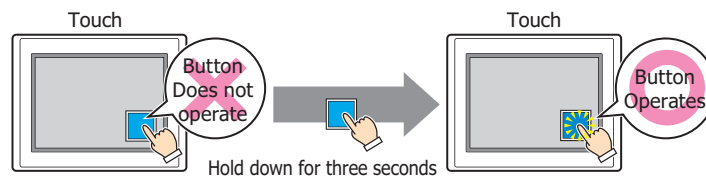

This feature protects against mistaken operation by ensuring that the button will not be activated if touched accidentally.

■ Security Group

Security groups are a security function for restricting the display and operation of parts.

Display: Selects the security group for which display of parts is restricted. (Default: None)

None: No security function is used.

Administrator, Operator, Reader: Three security groups are set up by default.

Click to display the Security Group Settings dialog box. If you create a security group on the Security Group Settings dialog box, you can select that created group. For details, refer to Chapter 21 "2.2 Adding and Editing Security Groups" on page 21-15.

Input: Selects the security group for which operation of parts is restricted. (Default: None)

None: No security function is used.



Administrator, Operator, Reader: Three security groups are set up by default.

Click to display the Security Group Settings dialog box. If you create a security group on the Security Group Settings dialog box, you can select that created group. For details, refer to Chapter 21 "2.2 Adding and Editing Security Groups" on page 21-15.



For details about security functions, refer to Chapter 21 "User Accounts and the Security Function" on page 21-1.

Example: If the user and security group for a part are set as follows:

User Name	 User1	 User2	 User3
Security Group	None	Group A	Group A, Group B

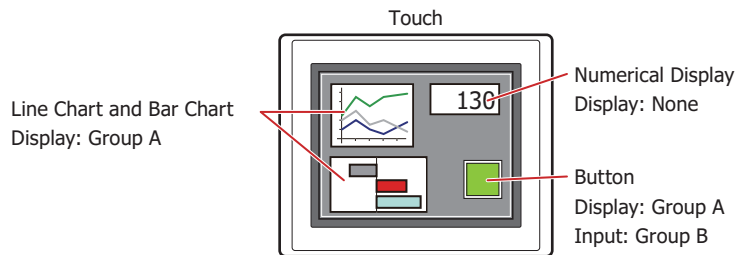

For User1, who is not included in the specified security group, Group A parts are not displayed. If the Password Screen is now opened and User2 logs in, Group A parts are displayed.

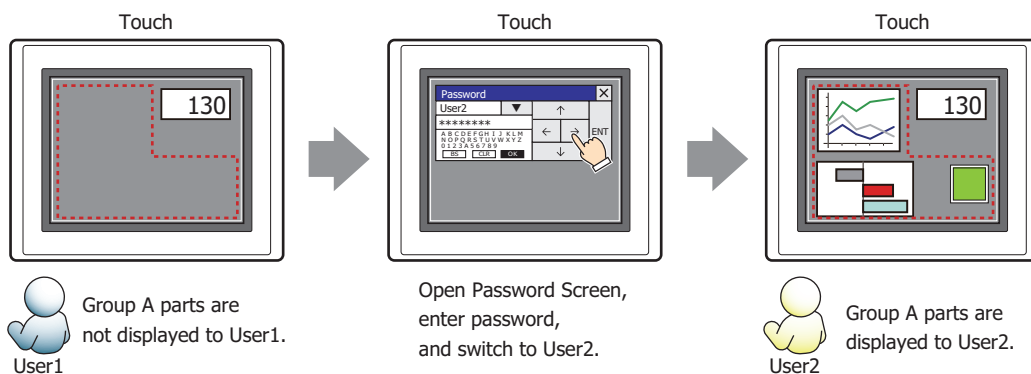

Since the display security group is Group A, User2 can view the buttons. But since the input security group is Group B, User2 cannot operate the buttons.

Suppose that the Password Screen is now opened and User3 logs in to the system. Group A buttons can be displayed, and Group B buttons can be operated.

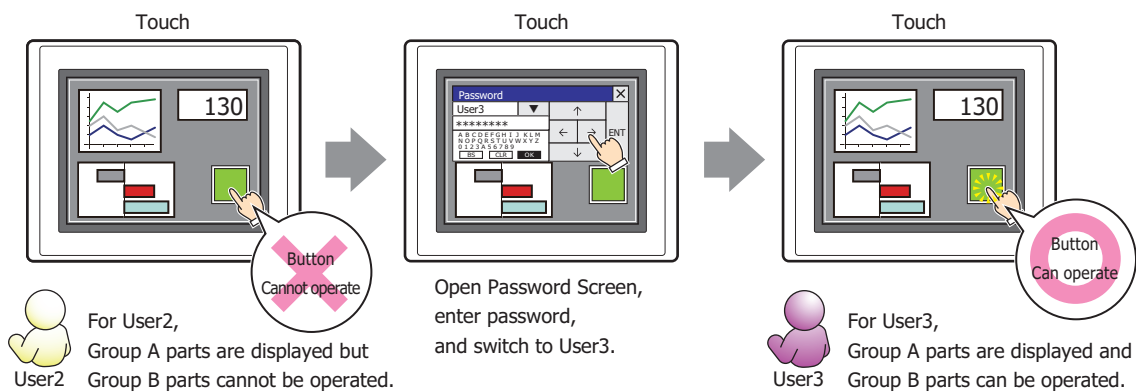

■ **No Touch Sound**

This function is to disable touch sounds only for specified parts when the Touch makes touch sounds. Select this check box to display disable touch sounds for this part.



To enable touch sounds on the Touch, select the **Enable Touch Sound** check box under the **System** tab of the Project Settings dialog box.

● Comment Tab

The **Comment** tab is used to specify the parts arranged on the editing screen, and the popup text displayed when the mouse pointer is placed close to **No.**, **Name**, or **Type** in the object list.



When there are multiple parts of the same shape on the screen, this feature makes it possible to distinguish between the parts without displaying the Properties dialog box for each part, by just mousing over the part.

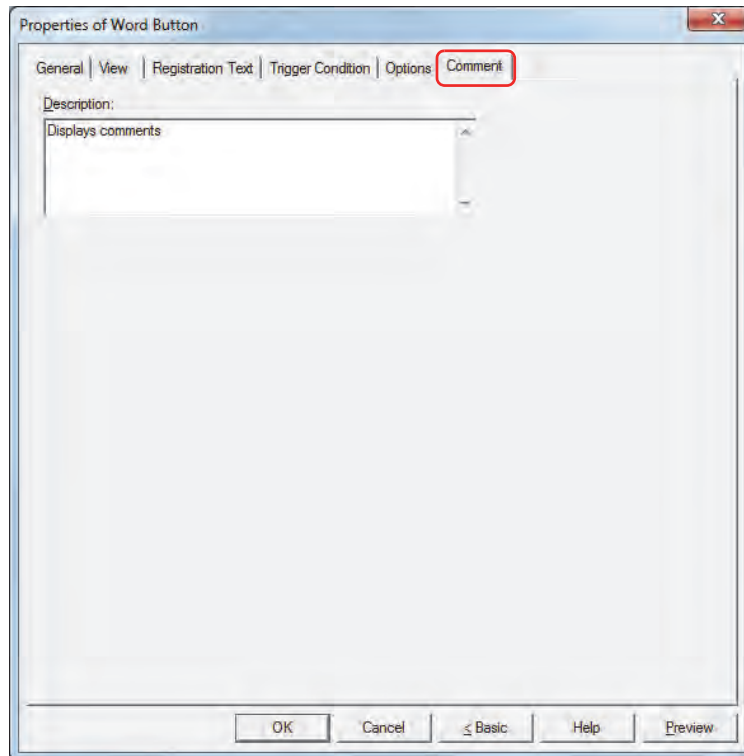

■ Description

Enter a comment about parts. The maximum number is 80 characters.

Example: When mousing over the Button on the editing screen

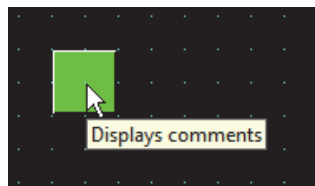

3 Goto Screen Button

3.1 How the Goto Screen Button is Used

Switches to another screen or displays a window.

- Pressing the button switches between Base Screens.

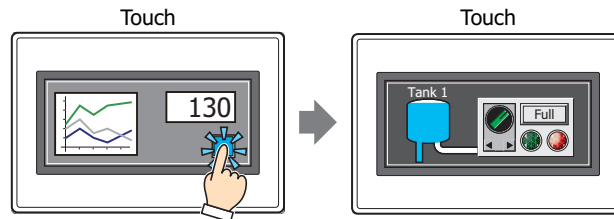

- Pressing the button opens and closes other windows (such as the Popup Screen, Device Monitor, Ladder Monitor, Password Screen, and Adjust Contrast Screen).

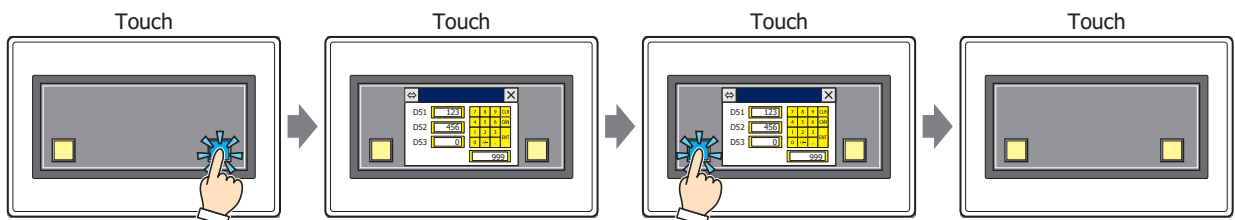

- Pressing the button switches to the System Mode.

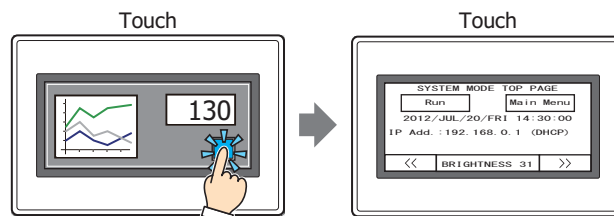

- Pressing the button resets the current screen.

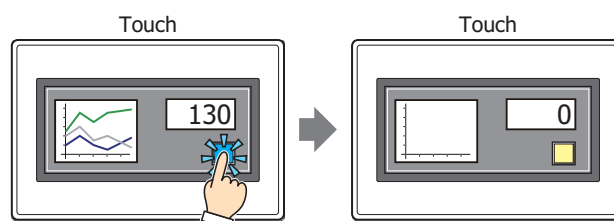

3.2 Goto Screen Button Configuration Procedure

This section describes the configuration procedure for Goto Screen Buttons.

- 1 On the **Home** tab, in the **Parts** group, click **Buttons**, and then click **Goto Screen Button**.

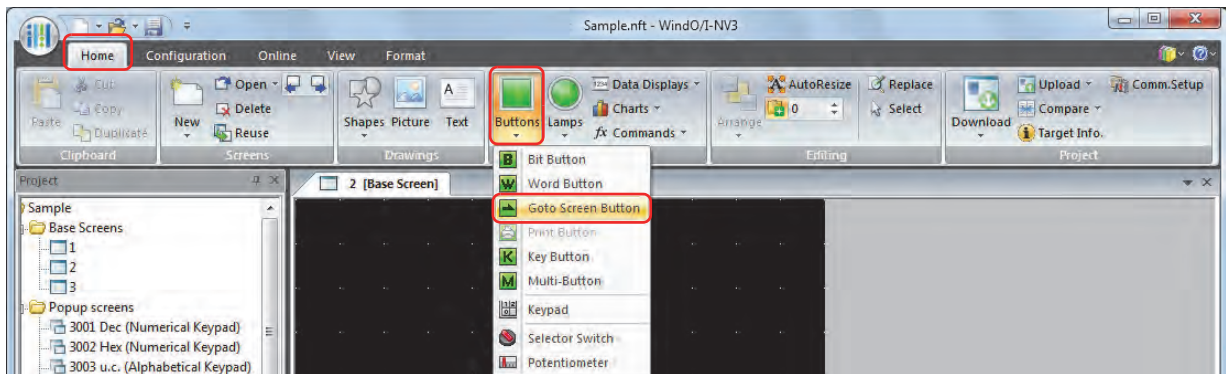

- 2 Click a point on the edit screen where you want to place the Goto Screen Button.
- 3 Double-click the dropped Goto Screen Button and a Properties dialog box will be displayed.
- 4 Change the settings on each tab as necessary.

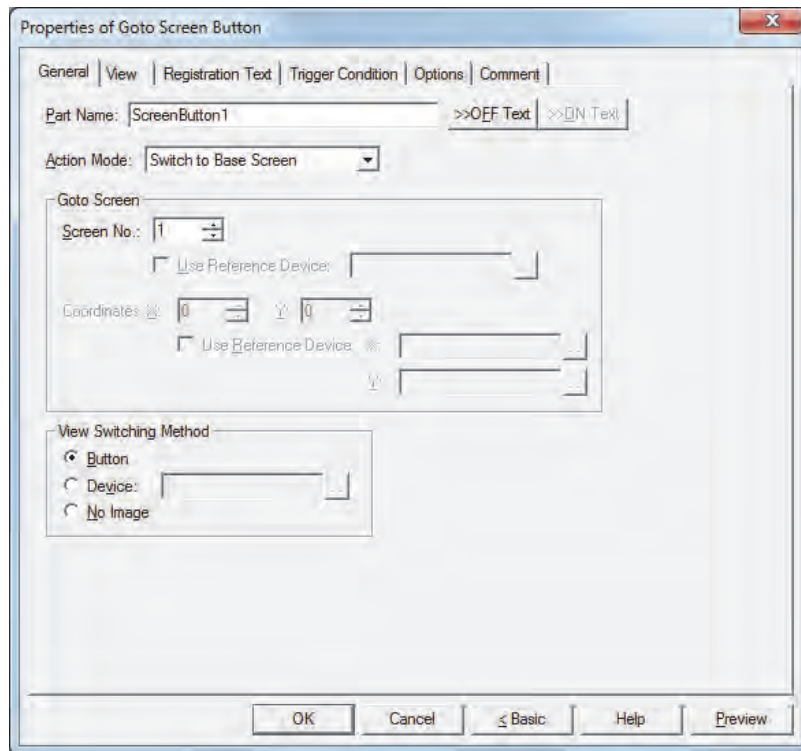

The **Trigger Condition** tab and **Options** tab only appear in Advanced mode.
To switch to Advanced mode, click **Advanced**.

3.3 Properties of Goto Screen Button Dialog Box

This section describes items and buttons in the Properties dialog box.

● General Tab

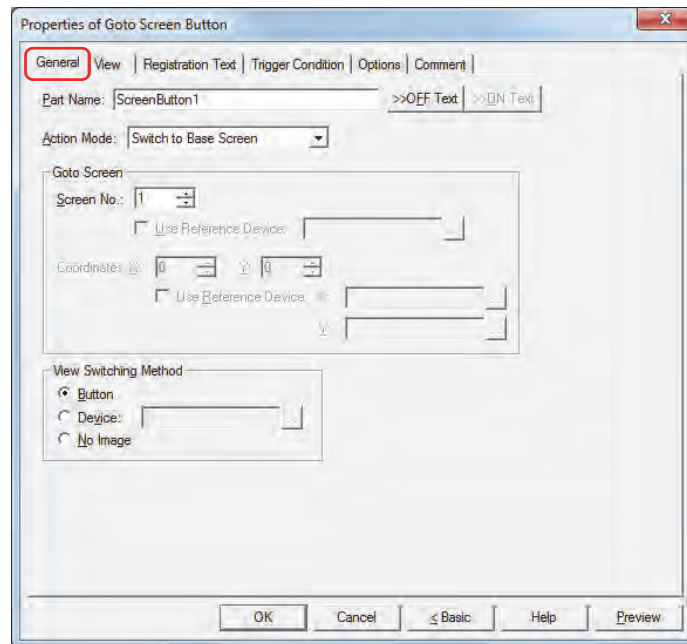

■ Part Name

Enter a name for the part. The maximum number is 20 characters.

■ >>OFF Text, >>ON Text

Applies the text entered in the **Part Name** field to the **Text** field under the **OFF** or **ON** fields on the **Registration Text** tab. This is used as the Registration Text when the button is OFF or ON.



To specify the Registration Text to use when the button is ON, select the **Set by State** check box on the **Registration Text** tab. If left unchecked, the same Registration Text assigned for the OFF state is displayed for the ON state as well.

■ Action Mode

Select the behavior of the button from the following:

Back to previous Screen:	Switches to the previous screen. Returns to up to 16 earlier screens.
Switch to Base Screen:	Switches between Base Screen. For details, refer to Chapter 4 "3 Base Screen" on page 4-14.
Open Popup Screen:	Opens a Popup Screen. For details, refer to Chapter 4 "4 Popup Screen" on page 4-22.
Close Popup Screen:	Closes a Popup Screen. For details, refer to Chapter 4 "4 Popup Screen" on page 4-22.
Open Device Monitor Screen:	Opens the Device Monitor Screen. For details, refer to Chapter 24 "2.2 Device Monitor" on page 24-19.
Close Device Monitor Screen:	Closes the Device Monitor Screen. For details, refer to Chapter 24 "2.2 Device Monitor" on page 24-19.
Open Ladder Monitor:	Opens the Ladder Monitor. For details, refer to Chapter 24 "2.3 Ladder Monitor" on page 24-23.
Close Ladder Monitor:	Closes the Ladder Monitor. For details, refer to Chapter 24 "2.3 Ladder Monitor" on page 24-23.
Open Password Screen:	Opens the Password Screen. For details, refer to Chapter 21 "4.1 Entering the Password on the Touch" on page 21-36.
Close Password Screen:	Closes the Password Screen. For details, refer to Chapter 21 "4.1 Entering the Password on the Touch" on page 21-36.
Open Adjust contrast Screen:	Opens the Adjust contrast Screen. For details, refer to Chapter 28 "1.3 Adjusting Screen Brightness" on page 28-2.
Close Adjust contrast Screen:	Closes the Adjust contrast Screen. For details, refer to Chapter 28 "1.3 Adjusting Screen Brightness" on page 28-2.
Switch to System Mode:	Switches to the Top Page in the System Mode. For details, refer to Chapter 28 "2 System Mode Overview" on page 28-3.
Reset current screen:	Resets the current Base Screen.



- **Open Ladder Monitor** and **Close Ladder Monitor** can only operate when ladder program is selected as the programming language in control function.
- When the current Base Screen is reset using the **Reset current screen** function, the window and internal devices restart as if the Base Screens were switched.

■ Goto Screen

Screen No.: If **Action Mode** is set to **Switch to Base Screen**, specify the Base Screen number to switch to (from 1 to 3,000). If **Action Mode** is set to **Open Popup Screen** or **Close Popup Screen**, specify the number of the Popup Screen to open or close (from 1 to 3,015). This setting is enabled only if **Action Mode** is set to **Switch to Base Screen**, **Open Popup Screen**, or **Close Popup Screen**.

Use Reference Device^{*1}: Select this check box and specify a device to specify the screen number using the value of the specified device.

Click to display the Device Address Settings dialog box. For the device address configuration procedure, refer to Chapter 2 "5.1 Device Address Settings" on page 2-61.

This setting is enabled only if **Action Mode** is set to **Open Popup Screen** or **Close Popup Screen**.

Coordinates X, Y: Specify the coordinates on the Base Screen for displaying a window. X and Y specify the upper left corner of the window using the upper left corner of the screen as the origin.

This setting is enabled only if **Action Mode** is set to **Open Popup Screen**, **Open Device Monitor Screen**, **Open Password Screen**, **Open Adjust contrast Screen**, or **Open Movie File Screen**.

Use Reference Device^{*1}: Select this check box and specify a device to specify the coordinates using the value of the specified device.

Click to display the Device Address Settings dialog box. For the device address configuration procedure, refer to Chapter 2 "5.1 Device Address Settings" on page 2-61.

This setting is enabled only if **Action Mode** is set to **Open Popup Screen**.

■ View Switching Method^{*1}

Select how to display the ON/OFF status of the button.

Button: Pressing the button changes the drawing object displayed.

Device: The drawing objects assigned to the OFF and ON states are displayed when the value of device is 0 and 1, respectively. Specifies the device used to switch the drawing object display.

Click to display the Device Address Settings dialog box. For the device address configuration procedure, refer to Chapter 2 "5.1 Device Address Settings" on page 2-61.

No Image: The button is not displayed on the screen. The button appears as a dashed line frame on the edit screen. Pressing the corresponding area on the Touch activates the assigned function. If **No Image** is selected, the settings for **View** and **Registration Text** are disabled.



Selecting **Device** in **View Switching Method** allows you to create an illuminated pushbutton.

The illuminated pushbutton switches state (or image) according to ON or OFF state of the device address, allowing you to display the state of a device that is being operated.

Example: When you set an external device address M0 as **Device** in **View Switching Method**, if the value of M0 changes, the display image will switched according to the value of M0 even if the button is not pressed.

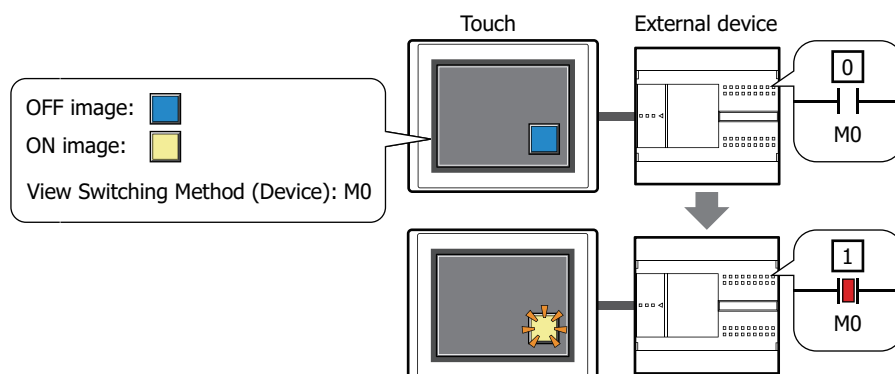

*1 Advanced mode only

● View Tab

Only **Coordinates** and **Size** can be configured when **No Image** is selected for **View Switching Method** on the **General** tab.

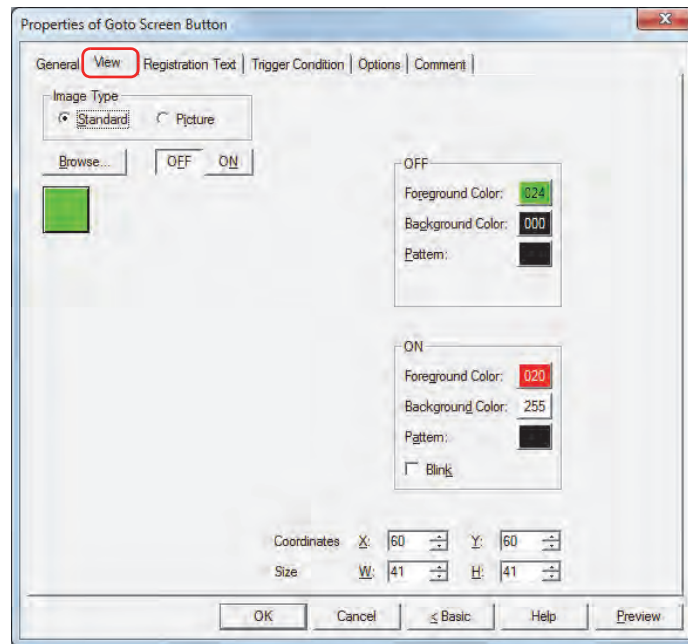

■ Image Type

Select the type of graphic to be used to represent the part.

Standard: Uses the default graphics contained within WindO/I-NV3.

Picture: Uses an image file saved in Picture Manager.

For details about image file restrictions, refer to Chapter 2 “1.4 Available Image Files” on page 2-18.

■ Browse

Select the type of graphic to be used to represent the part from the list of graphics. Click this button to display the View Browser or Picture Manager, depending on the setting for **Image Type**.

■ OFF button, ON button

Displays the graphic when ON or OFF. Clicking the **ON** button or **OFF** button switches the image displayed on the **View** tab.

■ OFF, ON

Selects the color and pattern of the standard graphic when ON and OFF.

Foreground Color, Background Color:

Selects the foreground and background colors of the standard graphic (color: 256 colors, monochrome: 8 shades).

Click the **Color** button to display the Color Palette. Select a color from the Color Palette.

Pattern: Selects a pattern for the standard graphic.

Click the **Pattern** button to display the Pattern Palette. Select a pattern from the Pattern Palette.

■ Blink

Select this check box if blinking is desired (alternating ON and OFF) when a part is ON.

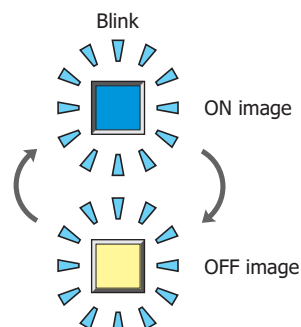

■ Coordinates

- X, Y: Sets the display position of parts using coordinates.
 The X and Y coordinates of parts are defined relative to an origin at the top-left corner of the screen.
- X: 0 to (Base Screen horizontal size - 1)
- Y: 0 to (Base Screen vertical size - 1)

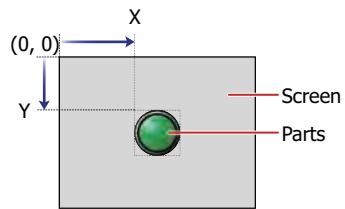

■ Size

- W, H: Sets width and height to define the size of parts.
- W: 20 to (Base Screen horizontal size)
- H: 20 to (Base Screen vertical size)

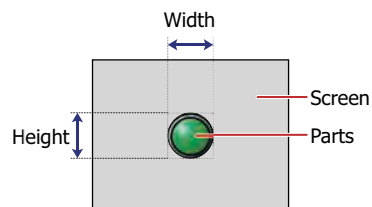

● Registration Text Tab

These options can only be configured when **Button** or **Device** is selected for **View Switching Method** on the **General** tab.

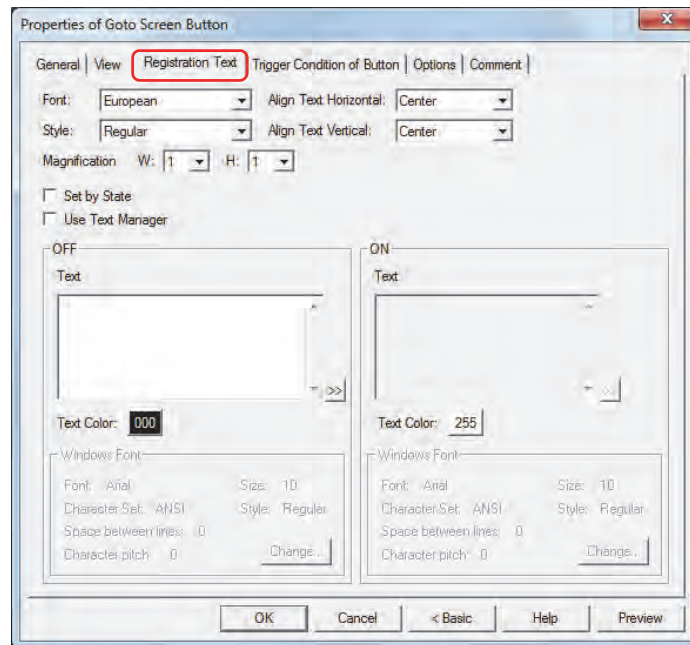

■ Font

Selects the font used for displaying text from the following.

Japanese, European, Chinese, Taiwanese, Korean, Central European, Baltic, Cyrillic, Windows

Can only be set when the **Use Text Manager** check box is cleared.

The characters that can be displayed depend on the font. For details, refer to Chapter 2 “1.2 Available Text” on page 2-5.

■ Style

Selects **Regular** or **Bold** for text style.

Can only be set when **Font** is set to **Japanese, European, Chinese, Taiwanese, Korean, Central European, Baltic** or **Cyrillic**.

■ Magnification

W, H: Selects the magnification (0.5, 1 to 8) for text display.

Can only be set when **Font** is set to **Japanese, European, Chinese, Taiwanese, Korean, Central European, Baltic** or **Cyrillic**.

■ Align Text Vertical

Selects text alignment in the vertical direction.

Top, Center, Bottom

For details, refer to Appendix “5 Text Alignment” on page A-5.

■ Align Text Horizontal

Selects text alignment in the horizontal direction.

Left, Center, Right, Center-Left

For details, refer to Appendix “5 Text Alignment” on page A-5.

■ Set by State

Select this check box if displaying different text when ON and OFF.

■ Use Text Manager

Select this check box if using the text registered in Text Manager for text display.

■ OFF, ON

Text: Inputs characters to be displayed on parts. The maximum number is 3,750 characters.
The characters that can be entered depend on the font selected using **Font**. For details, refer to Chapter 2 "1.2 Available Text" on page 2-5.



When entering Unicode characters click  to display the Unicode Input dialog box. Enter the characters using the Unicode Input dialog box then click **OK**.

Text ID: Specifies the Text Manager ID No. (1 to 32000) when using the text registered in Text Manager.

Click  to display Text Manager.

Can only be set when the **Use Text Manager** check box is selected.

Text Color: Selects the color of the text displayed on the part (color: 256 colors, monochrome: 8 shades).

Click the **Color** button to display the Color Palette. Select a color from the Color Palette.

Windows Font: Sets the font to be used as the Windows Font.

Select **Windows** using **Font** to display the current setting. To change the setting, click **Change** to display the Font dialog box.

Can only be set when the **Use Text Manager** check box is cleared.

For details, refer to Chapter 2 "Windows Font" on page 2-12.

● **Trigger Condition Tab**

The **Trigger Condition** tab is displayed in Advanced mode.

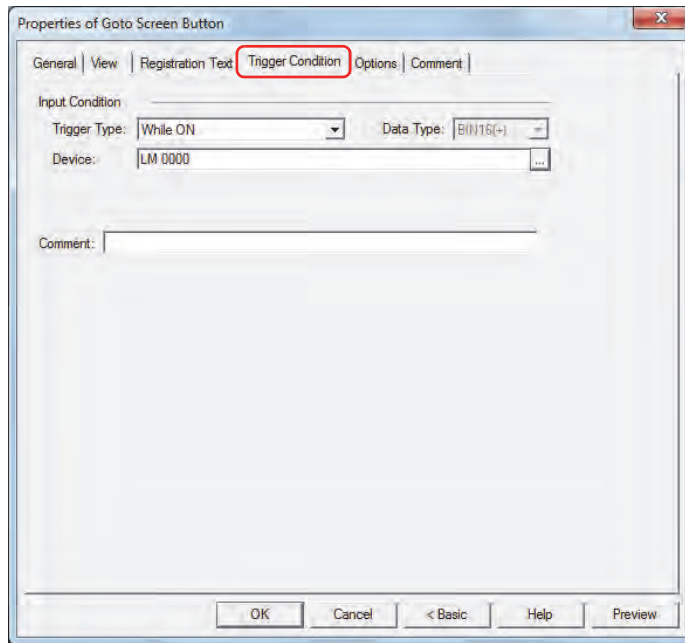

■ **Input Condition**

The Button is enabled and operational while the condition is satisfied. The Button is disabled and not operational while the condition is not satisfied.

Example: When **Trigger Type** is **While ON** and **Device** is LM0

While LM0 is 0, the condition is not satisfied and the Button is not operational.

While LM0 is 1, the condition is satisfied and the Button is operational.

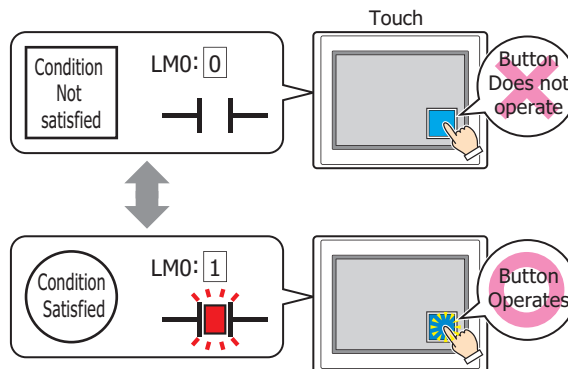

Trigger Type: Selects the condition to enable the Button from the following.

Always Enabled: The Button is always enabled.



While ON: Enables the Button when the value of device is 1.

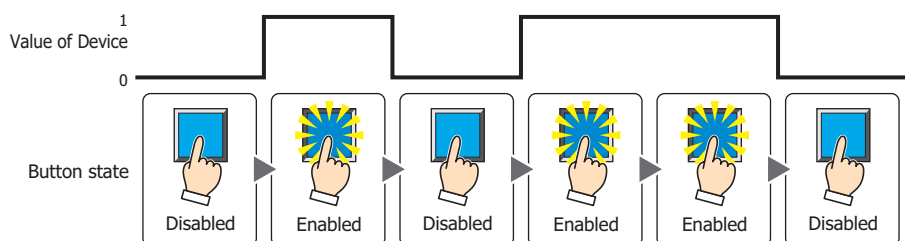

While OFF: Enables the Button when the value of device is 0.

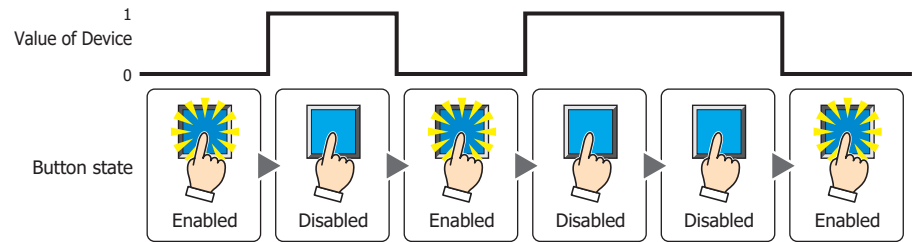

While satisfying the condition:

Enables the Button when the condition is satisfied.

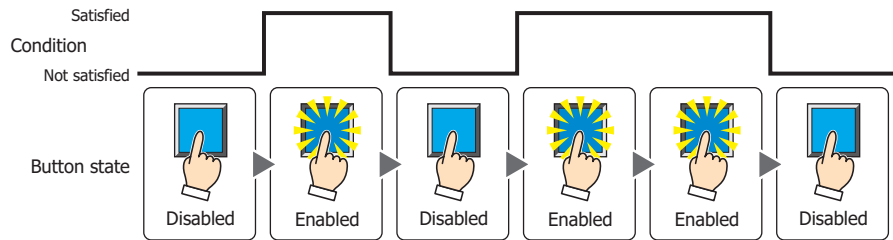

- Data Type:** Selects the type of data handled by the conditional expression for the input condition. This option can only be configured if **While satisfying the condition** is selected for **Trigger Type**. For details, refer to Chapter 2 "1.1 Available Data" on page 2-1.
- Device:** Specifies the bit device or bit of the word device to serve as the input condition. This option can only be configured when **While ON** or **While OFF** is selected for **Trigger Type**. Click to display the Device Address Settings dialog box. For the device address configuration procedure, refer to Chapter 2 "5.1 Device Address Settings" on page 2-61.
- Condition:** Specifies the conditional expression for the input condition. This option can only be configured when **While satisfying the condition** is selected for **Trigger Type**. Click to display the Trigger Condition Settings dialog box. For the conditional expression configuration procedure, refer to Chapter 2 "5.2 Setting Conditional Expressions" on page 2-63.
- Comment:** Enter a comment for the input condition. The maximum number is 80 characters.

● Options Tab

The **Options** tab is displayed in Advanced mode.

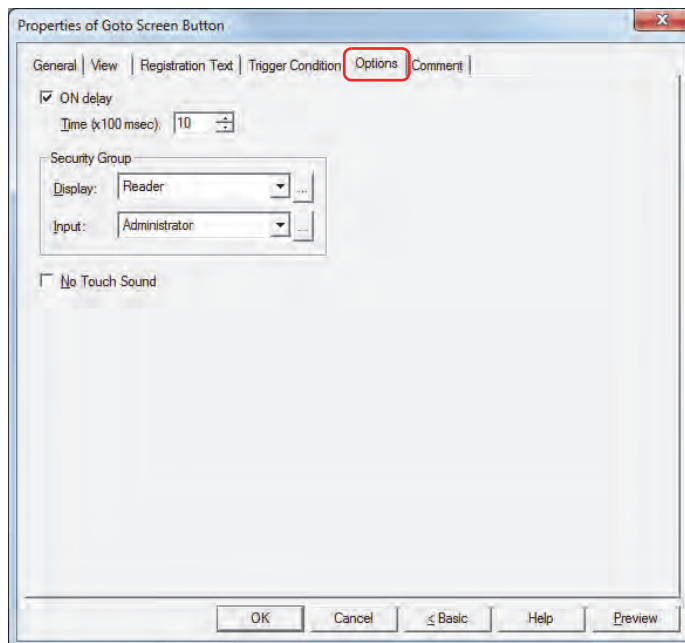

■ ON delay

Select this check box to use the ON delay function.

Time (x100 msec): Specify the length of time that the button must be held down before activation by selecting a value from 0 to 600 (units of 10 milliseconds).

The button activates after it is held down for a specified period of time.

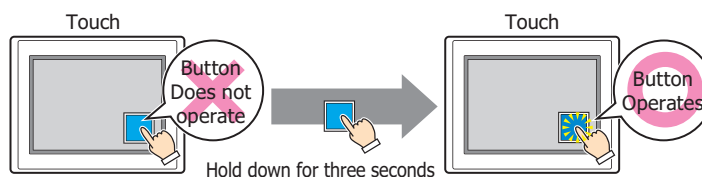

This feature protects against mistaken operation by ensuring that the button will not be activated if touched accidentally.

■ Security Group

Security groups are a security function for restricting the display and operation of parts.

Display: Selects the security group for which display of parts is restricted. (Default: None)

None: No security function is used.

Administrator, Operator, Reader: Three security groups are set up by default.

Click to display the Security Group Settings dialog box. If you create a security group on the Security Group Settings dialog box, you can select that created group. For details, refer to Chapter 21 "2.2 Adding and Editing Security Groups" on page 21-15.

Input: Selects the security group for which operation of parts is restricted. (Default: None)

None: No security function is used.



Administrator, Operator, Reader: Three security groups are set up by default.

Click to display the Security Group Settings dialog box. If you create a security group on the Security Group Settings dialog box, you can select that created group. For details, refer to Chapter 21 "2.2 Adding and Editing Security Groups" on page 21-15.



For details about security functions, refer to Chapter 21 "User Accounts and the Security Function" on page 21-1.

Example: If the user and security group for a part are set as follows:

User Name	 User1	 User2	 User3
Security Group	None	Group A	Group A, Group B

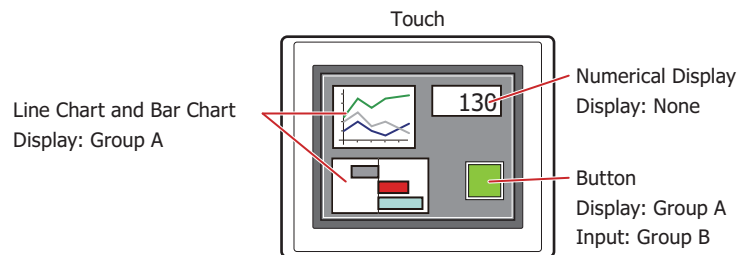

For User1, who is not included in the specified security group, Group A parts are not displayed. If the Password Screen is now opened and User2 logs in, Group A parts are displayed.

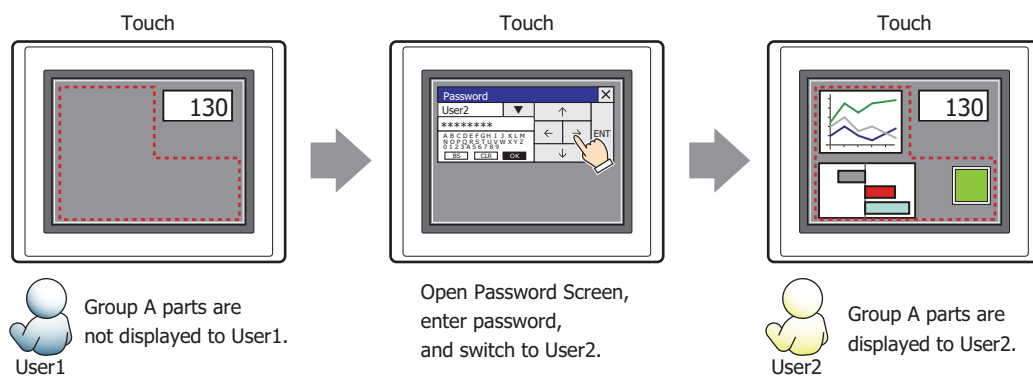

Since the display security group is Group A, User2 can view the buttons. But since the input security group is Group B, User2 cannot operate the buttons.

Suppose that the Password Screen is now opened and User3 logs in to the system. Group A buttons can be displayed, and Group B buttons can be operated.

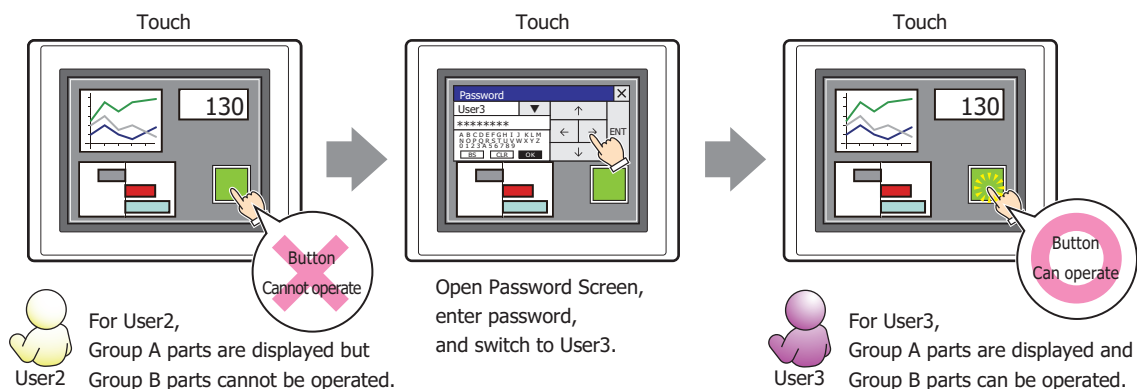

■ **No Touch Sound**

This function is to disable touch sounds only for specified parts when the Touch makes touch sounds.

Select this check box to display disable touch sounds for this part.



To enable touch sounds on the Touch, select the **Enable Touch Sound** check box under the **System** tab of the Project Settings dialog box.

● Comment Tab

The **Comment** tab is used to specify the parts arranged on the editing screen, and the popup text displayed when the mouse pointer is placed close to **No.**, **Name**, or **Type** in the object list.



When there are multiple parts of the same shape on the screen, this feature makes it possible to distinguish between the parts without displaying the Properties dialog box for each part, by just mousing over the part.

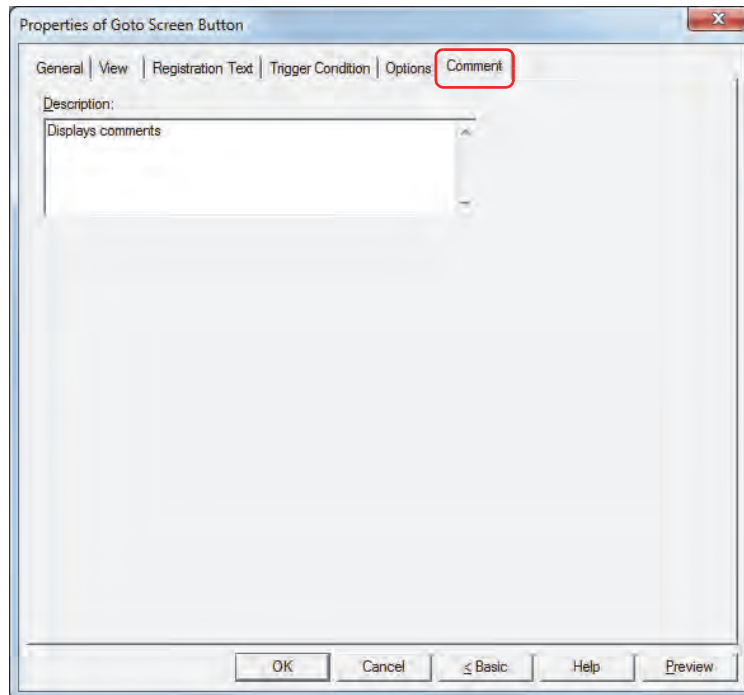

■ Description

Enter a comment about parts. The maximum number is 80 characters.

Example: When mousing over the Button on the editing screen

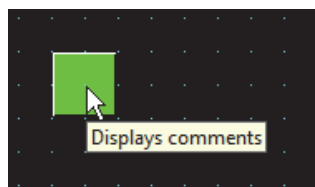

4 Key Button

4.1 How the Key Button is Used

Performs a variety of functions including uploading and downloading project files, and operating other parts.

- Entering numbers in the Numerical Input

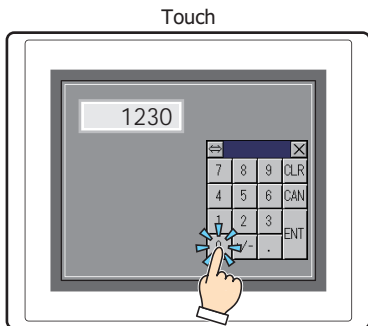

- Entering characters in the Character Input

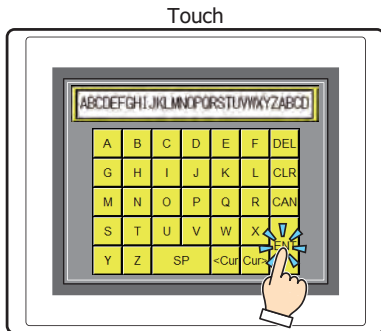

- Operating the Alarm List Display or Alarm Log Display

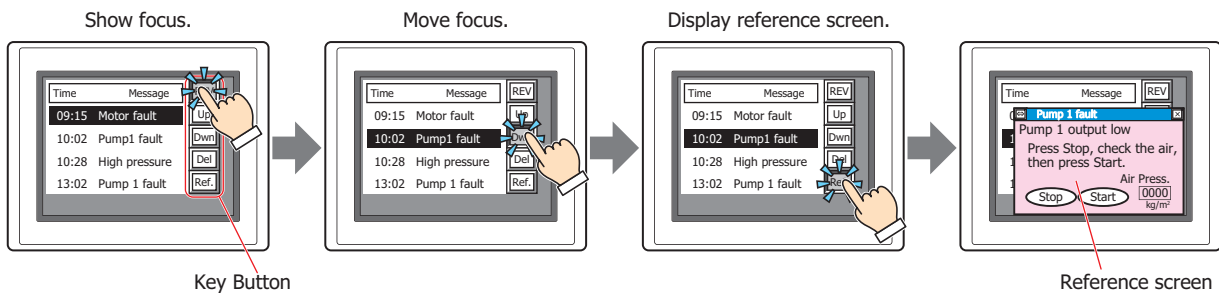

4.2 Key Button Configuration Procedure

This section describes the configuration procedure for Key Buttons.

- 1 On the **Home** tab, in the **Parts** group, click **Buttons**, and then click **Key Button**.

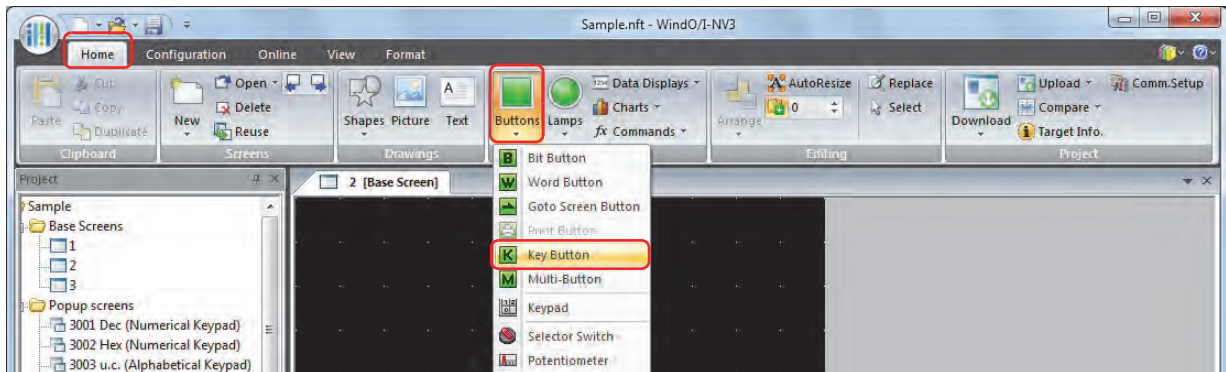

- 2 Click a point on the edit screen where you want to place the Key Button.
- 3 Double-click the dropped Key Button and a Properties dialog box will be displayed.
- 4 Change the settings on each tab as necessary.

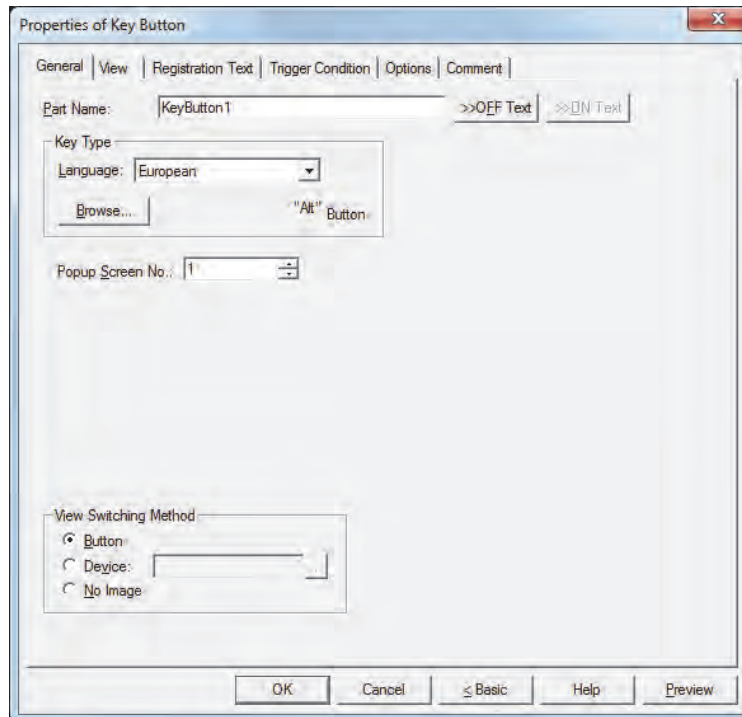

The **Trigger Condition** tab and **Options** tab only appear in Advanced mode. To switch to Advanced mode, click **Advanced**.

4.3 Properties of Key Button Dialog Box

This section describes items and buttons on the properties dialog box.

● General Tab

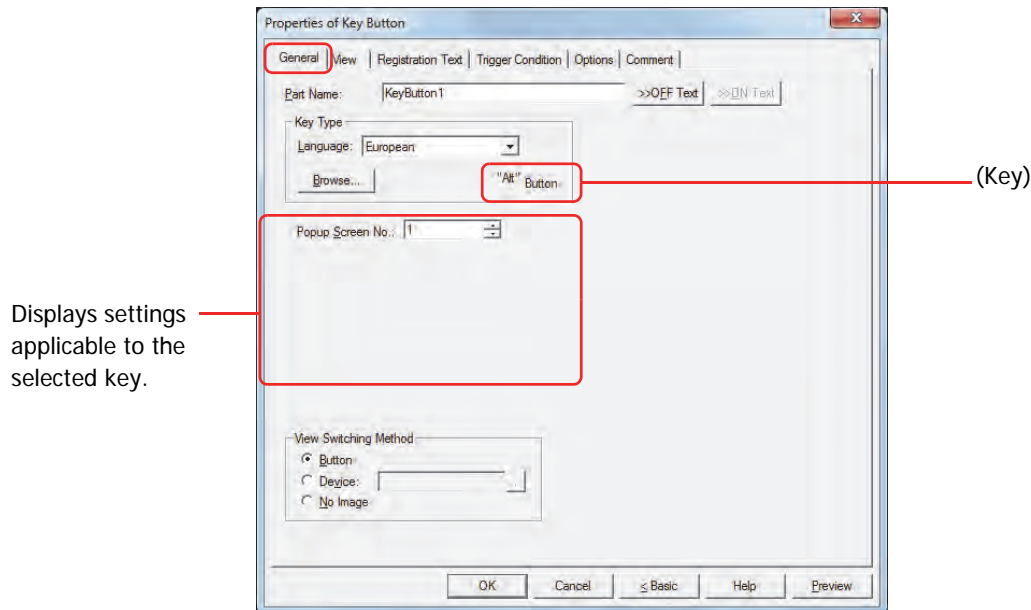

■ Part Name

Enter a name for the part. The maximum number is 20 characters.

■ >>OFF Text, >>ON Text

Applies the text entered in the **Part Name** field to the **Text** field under the **OFF** or **ON** fields on the **Registration Text** tab. This is used as the Registration Text when the button is OFF or ON.



To specify the Registration Text to use when the button is ON, select the **Set by State** check box on the **Registration Text** tab. If left unchecked, the same Registration Text assigned for the OFF state is displayed for the ON state as well.

■ Key Type

Select the function for the Key Button.

Language: Switches the display of the key that is displayed when **Keypad** is selected in Key Browser. These languages are available:

Japanese, European, Central European, Baltic, Cyrillic.

Browse: Opens the Key Browser when clicked. Select a key.
For details, refer to "4.5 Key Browser" on page 7-66.

(Key): Displays the name of the key selected using the Key Browser.



- When you select a key, the label for that key is assigned as the Registration Text.
- The function of Key button will affect on the next scan when the trigger condition is satisfied.

The settings explained below appear depending on the type of key selected.

■ Popup Screen No.

The **Alt** key switches the current Popup Screen used as a Keypad when this button is pressed.

Specify the Popup Screen number to open a Keypad for.

This setting is enabled only if **Alt** was selected using the Key Browser.

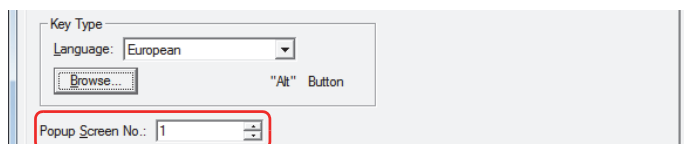

■ Scroll Size

Key Buttons **Pg. Up** and **Pg. Dwn** scroll the list up and down, respectively. Key Buttons **Fcs. Up** and **Fcs. Dwn** move the focus up and down, respectively. This settings specifies the number of pages or lines (1 to 1023 lines) to scroll or move the focus per each press of the button.

This setting is enabled only if **Pg. Up**, **Pg. Dwn**, **Fcs. Up**, and **Fcs. Dwn** are selected using the Key Browser.

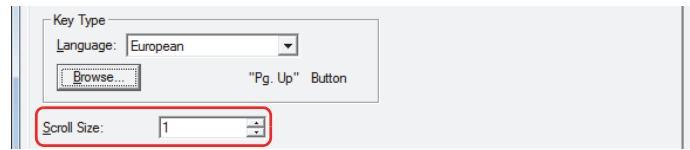

■ Transfer Setting

Key Buttons **Download Project** and **Upload Project** perform the data transfer function specified by their names. These settings specify the source, data to be transferred, and destination.

This setting is enabled only if one of these keys is selected after clicking **Data Transfer** in the Key Browser.

If **Download Project** is selected.

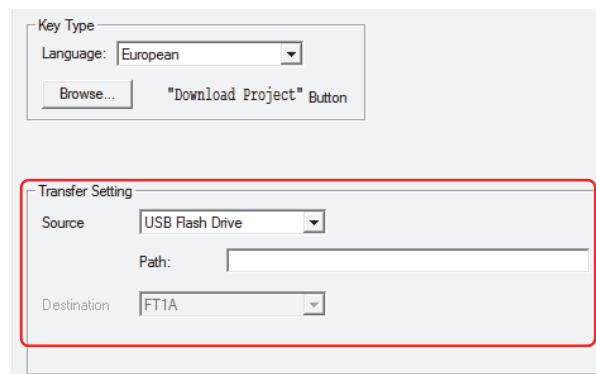

Source: This is set to the USB flash drive on which the project file to transfer (.ZNV) was saved.

File Path: Specify the path to the project file (.ZNV) to transfer. The maximum number is 247 characters.

Example: Where "FT_DEMO_1.ZNV" is a project file saved on the root directory of a USB flash drive:
FT_DEMO_1.ZNV

If **Upload Project** is selected.

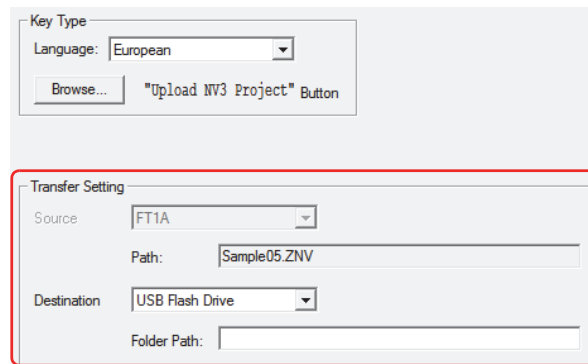

Destination: Specify where to save the project uploaded from Touch. The location is the USB flash drive.

Folder Path: Specify the path to the folder where the uploaded project file will be saved. The maximum number is 247 characters.

Example: To save it to the folder "Uploaded_Project" on a USB flash drive:
Uploaded_Project

■ View Switching Method*1

Select how to display the ON/OFF status of the button.

Button: Pressing the button changes the drawing object displayed.

Device: The drawing objects assigned to the OFF and ON states are displayed when the value of device is 0 and 1, respectively. Specifies the device used to switch the drawing object display.

Click  to display the Device Address Settings dialog box. For the device address configuration procedure, refer to Chapter 2 "5.1 Device Address Settings" on page 2-61.

No Image: The button is not displayed on the screen. The button appears as a dashed line frame on the edit screen. Pressing the corresponding area on the Touch activates the assigned function. If **No Image** is selected, the settings for **View** and **Registration Text** are disabled.



Selecting **Device** in **View Switching Method** allows you to create an illuminated pushbutton.

The illuminated pushbutton switches state (or image) according to ON or OFF state of the device address, allowing you to display the state of a device that is being operated.

Example: When you set an external device address M0 as **Device** in **View Switching Method**, if the value of M0 changes, the display image will be switched according to the value of M0 even if the button is not pressed.

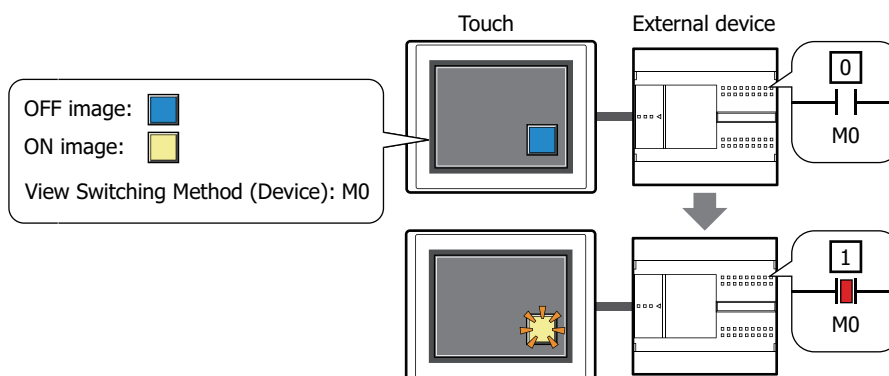

*1 Advanced mode only

● View Tab

Only **Coordinates** and **Size** can be configured when **No Image** is selected for **View Switching Method** on the **General** tab.

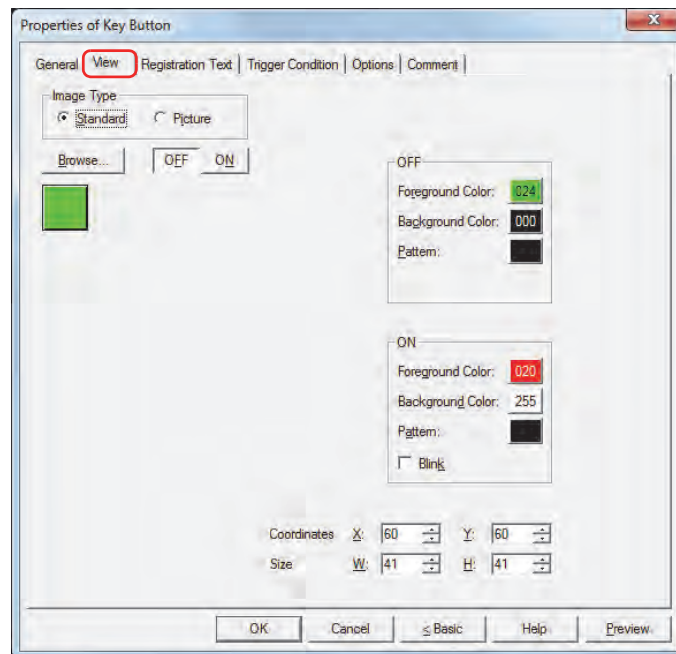

■ Image Type

Select the type of graphic to be used to represent the part.

Standard: Uses the default graphic for WindO/I-NV3.

Picture: Uses an image file saved using Picture Manager.

For details about image file restrictions, refer to Chapter 2 "1.4 Available Image Files" on page 2-18.

■ Browse

Select the type of graphic to be used to represent the part from the list of graphics. Click this button to display the View Browser or Picture Manager, depending on the setting for **Image Type**.

■ OFF button, ON button

Displays the graphic when ON or OFF. Clicking the **ON** button or **OFF** button switches the image displayed on the **View** tab.

■ OFF, ON

Selects the color and pattern of the standard graphic when ON and OFF.

Foreground Color, Background Color:

Selects the foreground and background colors of the standard graphic (color: 256 colors, monochrome: 8 shades).

Click the **Color** button to display the Color Palette. Select a color from the Color Palette.

Pattern: Selects a pattern for the standard graphic.

Click the **Pattern** button to display the Pattern Palette. Select a pattern from the Pattern Palette.

■ Blink

Select this check box if blinking is desired (alternating ON and OFF) when a part is ON.

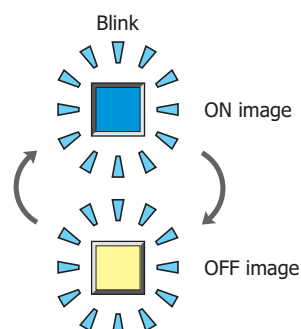

■ Coordinates

- X, Y: Sets the display position of parts using coordinates.
The X and Y coordinates of parts are defined relative to an origin at the top-left corner of the screen.
- X: 0 to (Base Screen horizontal size - 1)
- Y: 0 to (Base Screen vertical size - 1)

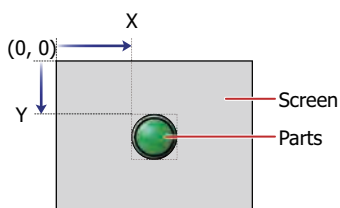

■ Size

- W, H: Sets width and height to define the size of parts.
- W: 20 to (Base Screen horizontal size)
- H: 20 to (Base Screen vertical size)

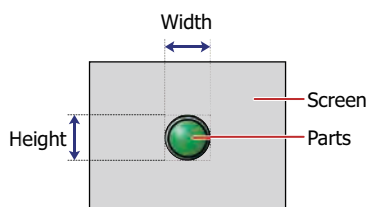

● Registration Text Tab

These options can only be configured when **Button** or **Device** is selected for **View Switching Method** on the **General** tab.

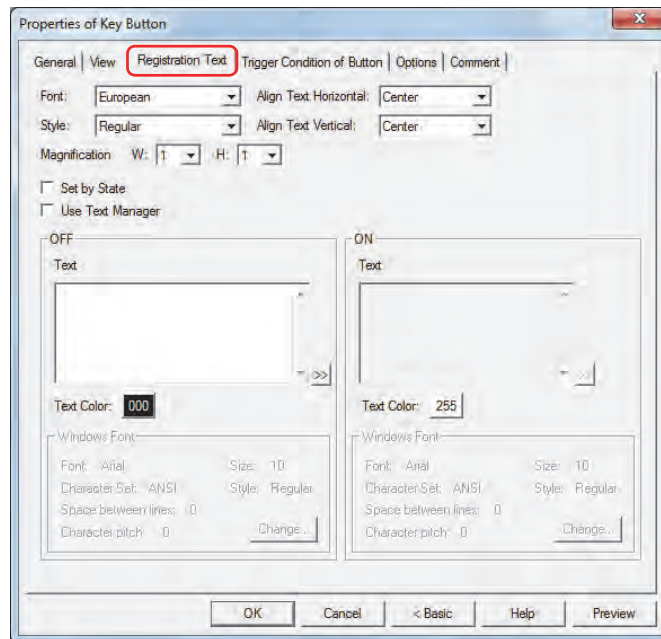

■ Font

Selects the font used for displaying text from the following.

Japanese, European, Chinese, Taiwanese, Korean, Central European, Baltic, Cyrillic, Windows

Can only be set when the **Use Text Manager** check box is cleared.

The characters that can be displayed depend on the font. For details, refer to Chapter 2 "1.2 Available Text" on page 2-5.

■ Style

Selects **Regular** or **Bold** for text style.

Can only be set when **Font** is set to **Japanese, European, Chinese, Taiwanese, Korean, Central European, Baltic** or **Cyrillic**.

■ Magnification

W, H: Selects the magnification (0.5, 1 to 8) for text display.

Can only be set when **Font** is set to **Japanese, European, Chinese, Taiwanese, Korean, Central European, Baltic** or **Cyrillic**.

■ Align Text Vertical

Selects text alignment in the vertical direction.

Top, Center, Bottom

For details, refer to Appendix "5 Text Alignment" on page A-5.

■ Align Text Horizontal

Selects text alignment in the horizontal direction.

Left, Center, Right, Center-Left

For details, refer to Appendix "5 Text Alignment" on page A-5.

■ Set by State

Select this check box if displaying different text when ON and OFF.

■ Use Text Manager

Select this check box if using the text registered in Text Manager for text display.

■ OFF, ON

Text: Inputs characters to be displayed on parts. The maximum number is 3,750 characters.
The characters that can be entered depend on the font selected using **Font**. For details, refer to Chapter 2 "1.2 Available Text" on page 2-5.



When entering Unicode characters click  to display the Unicode Input dialog box. Enter the characters using the Unicode Input dialog box then click **OK**.

Text ID: Specifies the Text Manager ID No. (1 to 32000) when using the text registered in Text Manager.

Click  to display Text Manager.

Can only be set when the **Use Text Manager** check box is selected.

Text Color: Selects the color of the text displayed on the part (color: 256 colors, monochrome: 8 shades).

Click the **Color** button to display the Color Palette. Select a color from the Color Palette.

Windows Font: Sets the font to be used as the Windows Font.

Select **Windows** using **Font** to display the current setting. To change the setting, click **Change** to display the Font dialog box.

Can only be set when the **Use Text Manager** check box is cleared.

For details, refer to Chapter 2 "Windows Font" on page 2-12.

● **Trigger Condition Tab**

The **Trigger Condition** tab is displayed in Advanced mode.

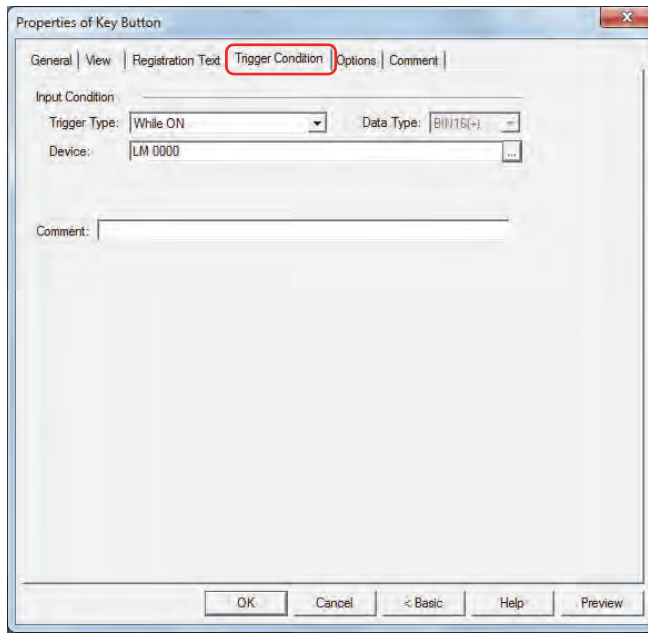

■ **Input Condition**

The Button is enabled and operational while the condition is satisfied. The Button is disabled and not operational while the condition is not satisfied.

Example: When **Trigger Type** is **While ON** and **Device** is LM0

While LM0 is 0, the condition is not satisfied and the Button is not operational.

While LM0 is 1, the condition is satisfied and the Button is operational.

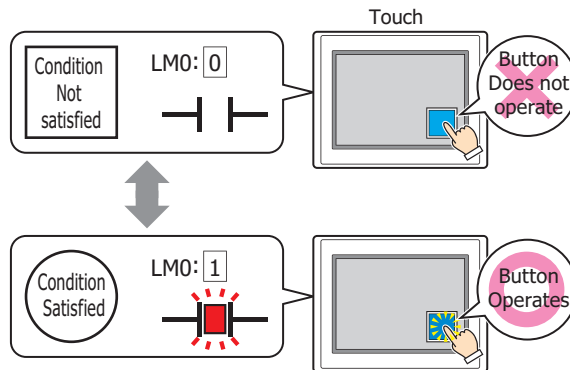

Trigger Type: Selects the condition to enable the Button from the following.

Always Enabled: The Button is always enabled.



While ON: Enables the Button when the value of device is 1.

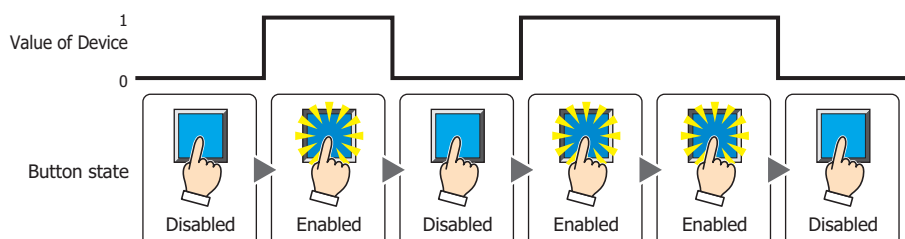

While OFF: Enables the Button when the value of device is 0.

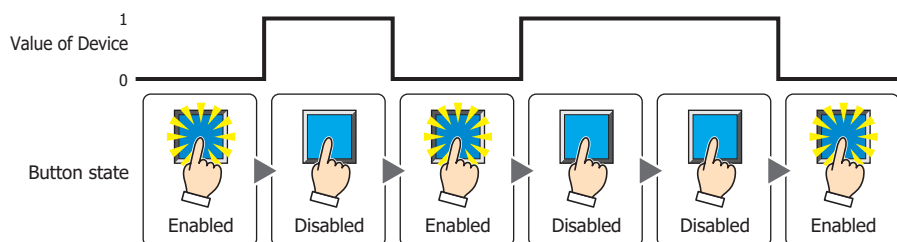

While satisfying the condition:

Enables the Button when the condition is satisfied.

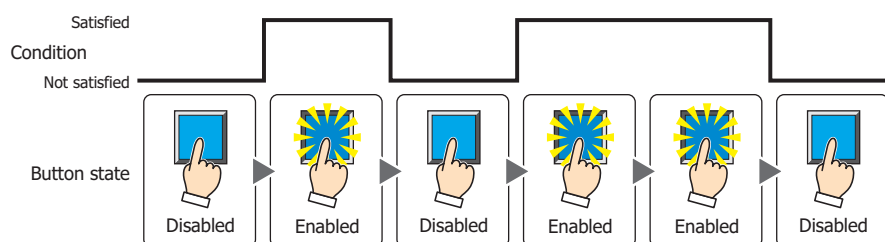

- Data Type:** Selects the type of data handled by the conditional expression for the input condition. This option can only be configured if **While satisfying the condition** is selected for **Trigger Type**. For details, refer to Chapter 2 "1.1 Available Data" on page 2-1.
- Device:** Specifies the bit device or bit of the word device to serve as the input condition. This option can only be configured when **While ON** or **While OFF** is selected for **Trigger Type**. Click to display the Device Address Settings dialog box. For the device address configuration procedure, refer to Chapter 2 "5.1 Device Address Settings" on page 2-61.
- Condition:** Specifies the conditional expression for the input condition. This option can only be configured when **While satisfying the condition** is selected for **Trigger Type**. Click to display the Trigger Condition Settings dialog box. For the conditional expression configuration procedure, refer to Chapter 2 "5.2 Setting Conditional Expressions" on page 2-63.
- Comment:** Enter a comment for the input condition. The maximum number is 80 characters.

● Options Tab

The **Options** tab is displayed in Advanced mode.

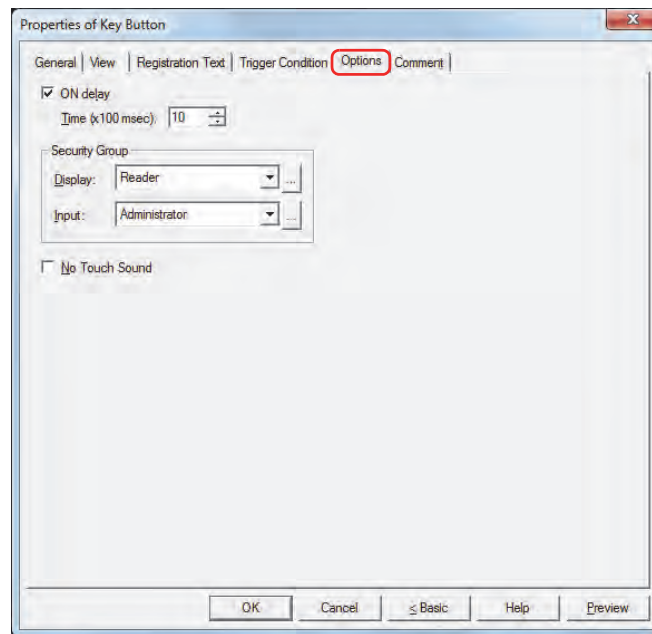

■ ON delay

Select this check box to use the ON delay function.

Time (x100 msec): Specify the length of time that the button must be held down before activation by selecting a value from 0 to 600 (units of 10 milliseconds).

The button activates after it is held down for a specified period of time.

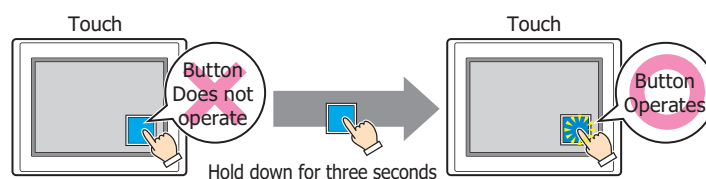

This feature protects against mistaken operation by ensuring that the button will not be activated if touched accidentally.

■ Security Group

Security groups are a security function for restricting the display and operation of parts.

Display: Selects the security group for which display of parts is restricted. (Default: None)

None: No security function is used.

Administrator, Operator, Reader: Three security groups are set up by default.

Click to display the Security Group Settings dialog box. If you create a security group on the Security Group Settings dialog box, you can select that created group. For details, refer to Chapter 21 "2.2 Adding and Editing Security Groups" on page 21-15.

Input: Selects the security group for which operation of parts is restricted. (Default: None)

None: No security function is used.



Administrator, Operator, Reader: Three security groups are set up by default.

Click to display the Security Group Settings dialog box. If you create a security group on the Security Group Settings dialog box, you can select that created group. For details, refer to Chapter 21 "2.2 Adding and Editing Security Groups" on page 21-15.



For details about security functions, refer to Chapter 21 "User Accounts and the Security Function" on page 21-1.

Example: If the user and security group for a part are set as follows:

User Name	 User1	 User2	 User3
Security Group	None	Group A	Group A, Group B

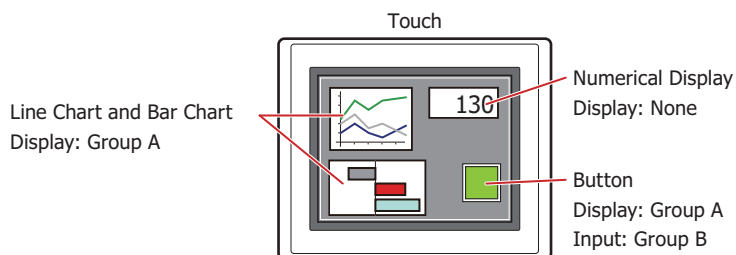

For User1, who is not included in the specified security group, Group A parts are not displayed. If the Password Screen is now opened and User2 logs in, Group A parts are displayed.

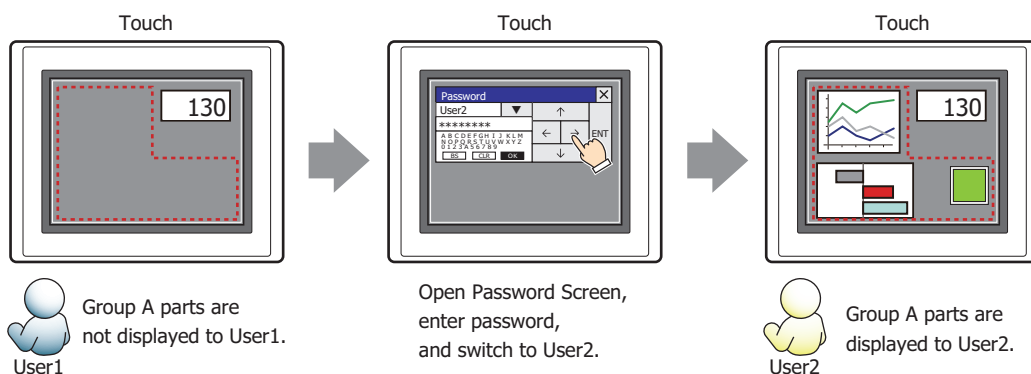

Since the display security group is Group A, User2 can view the buttons. But since the input security group is Group B, User2 cannot operate the buttons.

Suppose that the Password Screen is now opened and User3 logs in to the system. Group A buttons can be displayed, and Group B buttons can be operated.

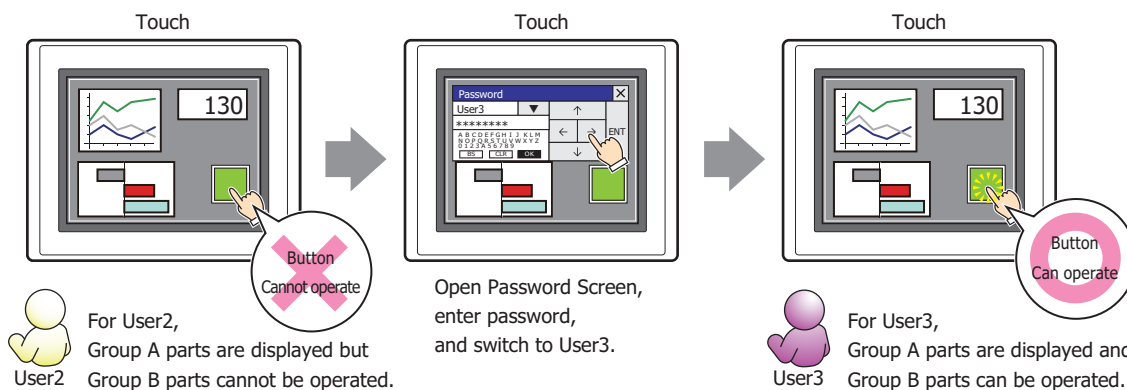

■ **No Touch Sound**

This function is to disable touch sounds only for specified parts when the Touch makes touch sounds. Select this check box to display disable touch sounds for this part.



To enable touch sounds on the Touch, select the **Enable Touch Sound** check box under the **System** tab of the Project Settings dialog box.

● Comment Tab

The **Comment** tab is used to specify the parts arranged on the editing screen, and the popup text displayed when the mouse pointer is placed close to **No.**, **Name**, or **Type** in the object list.



When there are multiple parts of the same shape on the screen, this feature makes it possible to distinguish between the parts without displaying the Properties dialog box for each part, by just mousing over the part.

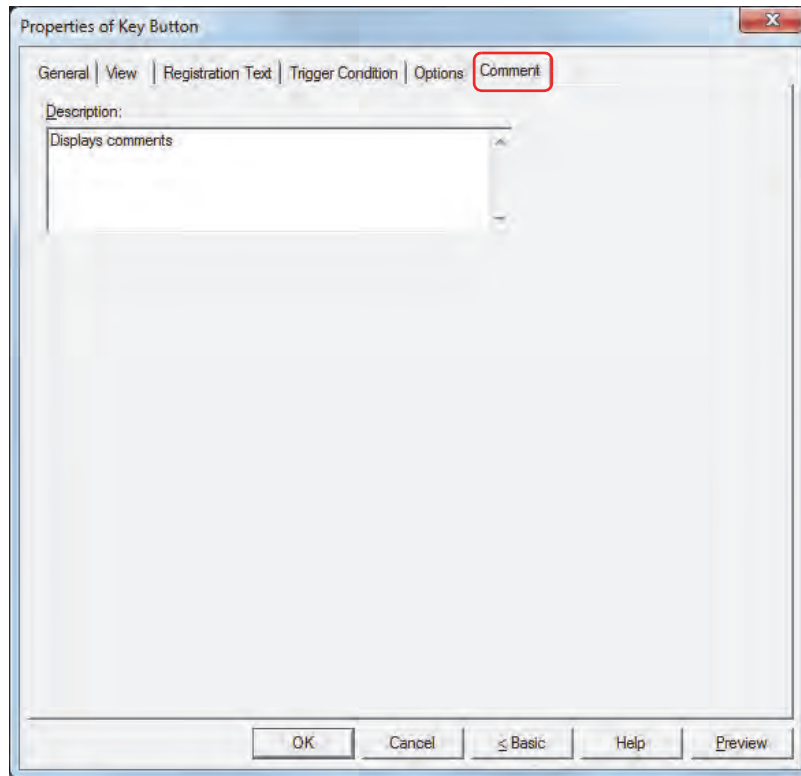

■ Description

Enter a comment about parts. The maximum number is 80 characters.

Example: When mousing over the Button on the editing screen

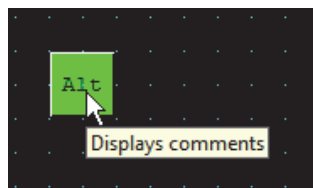

4.4 Key Buttons

● For Keypad

These keys can be used for Numerical Input and Character Input:

■ Numerical Input Keypad

Key	Operation
.	Inputs a decimal point.
0 to 9	Inputs a number from 0 to 9.
A to F	Inputs a character from A to F.
+/-	Toggles the sign.
CAN	Clears the data input thus far and cancels the input. Closes the Popup Screen that is opened as the Keypad, if this key is placed on it.
CLR	Clears the data input thus far and stands by for further input.
BS	Deletes the character to the left of the character at the cursor position.
ENT	Writes the characters input as a numeric value to a device. After the data is written, the focus can be moved according to the Focus Order setting. Focus Order can be set on the Options tab of the Screen Properties dialog box.
< Fcs.	Moves the focus one item before the current one as per the Focus Order setting. Focus Order can be set on the Options tab of the Screen Properties dialog box.
Fcs. >	Moves the focus one item after the current one as per the Focus Order setting. Focus Order can be set on the Options tab of the Screen Properties dialog box.
Alt	The Alt key switches the Popup Screen opened as a Keypad. Closes the Popup Screen that is opened as the Keypad and opens another Popup Screen as the Keypad.



The **Alt** key can be used, for instance, to switch between a decimal and a hexadecimal Keypad.

■ Character Input Keypad

Key	Operation
!	Inputs a !.
"	Inputs a ".
#	Inputs a #.
\$	Inputs a \$.
%	Inputs a %.
&	Inputs a &.
'	Inputs a '.
(Inputs a (.
)	Inputs a).
*	Inputs a *.
+	Inputs a +.
,	Inputs a ,.
-	Inputs a -.
.	Inputs a .
/	Inputs a /.
0 to 9	Inputs a number from 0 to 9.
:	Inputs a :.
;	Inputs a ;.
<	Inputs a <.
=	Inputs a =.

Key	Operation
>	Inputs a >.
?	Inputs a ?.
@	Inputs a @.
A to Z	Inputs a character from A to Z.
[Inputs a [.
¥	Inputs a ¥.
]	Inputs a].
^	Inputs a ^.
_	Inputs a _.
'	Inputs a '.
a to z	Inputs a character from a to z.
{	Inputs a {.
	Inputs a .
}	Inputs a }.
~	Inputs a ~.
(Keys dependent on Language setting)	Inputs the text displayed according to the language selected in the Language setting. For a list of the characters input using these keys, refer to Chapter 2 "1.2 Available Text" on page 2-5.
CAN	Clears the data input thus far and cancels the input. Closes the Popup Screen if it is opened as a Keypad.
CLR	Clears the data input thus far and stands by for further input.
DEL	Deletes the character at the cursor.
BS	Deletes the character to the left the cursor.
ENT	Writes the text input in ASCII code form to a device. After the data is written, the focus can be moved according to the Focus Order setting. Focus Order can be set on the Options tab of the Screen Properties dialog box.
SP	Inputs a space.
Cur. >	Moves the cursor right.
< Cur.	Moves the cursor left.
< Fcs.	Moves the focus one item before the current one as per the Focus Order setting. Focus Order can be set on the Options tab of the Screen Properties dialog box.
Fcs. >	Moves the focus one item after the current one as per the Focus Order setting. Focus Order can be set on the Options tab of the Screen Properties dialog box.
Alt	The Alt key switches the Popup Screen opened as a Keypad. Closes the Popup Screen that is opened as the Keypad and opens another Popup Screen as the Keypad.



Press and hold the **< Cur.** and **Cur. >** keys for more than one second to cause it to move repeatedly.



The **Alt** key can be used, for instance, to switch between Keypads for lower case and upper case letters.

- For Data Transfer Keys

These keys can be used to execute Data Transfer functions.

Key	Operation
Download Project	Downloads a project file (ZNV format) saved on an external memory to the Touch.
Upload Project	Uploads the project used for operation on the Touch and saves the project file (ZNV format) to an external memory.

For details about Data Transfer functions, refer to Chapter 25 "Data Transfer Function" on page 25-1.

- For Alarm Displays

These keys can be used for the Alarm List Display and Alarm Log Display parts.

- Alarm List Display

Key	Operation
Pg. Up	Scrolls up the number of lines (1 to 1023) specified in Scroll Size .
Pg. Dwn	Scrolls down the number of lines (1 to 1023) specified in Scroll Size .
Fcs. Up	Moves the focus the number of lines (1 to 1023) specified in Scroll Size . The current point of focus can be shown by pressing REVERSE .
Fcs. Dwn	Moves the focus the number of lines (1 to 1023) specified in Scroll Size . The current point of focus can be shown by pressing REVERSE .
REVERSE	Toggles the focus between show and hide.
Ref.	The reference screen appears.



Press and hold the **Pg. Up**, **Pg. Dwn**, **< Cur.**, and **Cur. >** keys for more than one second to move the focus repeatedly.

- Alarm Log Display

Key	Operation
Fcs. Up	Moves the focus the number of lines (1 to 1023) specified in Scroll Size . The current point of focus can be shown by pressing REVERSE .
Fcs. Dwn	Moves the focus the number of lines (1 to 1023) specified in Scroll Size . The current point of focus can be shown by pressing REVERSE .
REVERSE	Toggles the focus between show and hide.
CHECK	Shows the date and time the alarm that has focus was confirmed.
All Chk.	Shows the date and time that all alarms were confirmed.
Del.	Clears the alarm that has focus.
Del. All	Clears all alarms.
Ref.	Shows the reference screen for the alarm that has focus.
Stop Buzzer and Screen Flashing	Stops the sound of the buzzer and screen flashing when an alarm occurs.



Press and hold the **Fcs. Up** and **Fcs. Dwn** keys for more than one second to move the focus repeatedly.

4.5 Key Browser

Select the key using the Key Browser. The Key Browser closes when a key is selected. The name of the key is shown in **Key Type**. Settings that apply to the selected key are displayed.



When you select a key, the label for that key is assigned as the Registration Text.

Select the key type from the following uses:

Keypad, Data Transfer, Alarm Display

■ Keypad

These buttons are used for Numerical Input and Character Input:

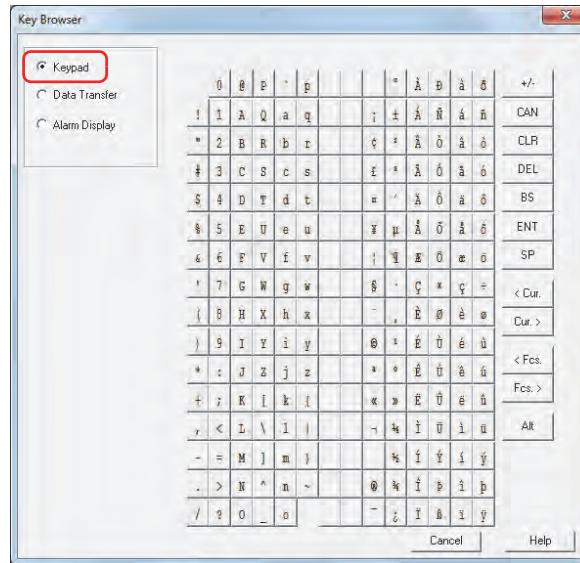

■ Data Transfer

These buttons are used to execute Data Transfer functions.

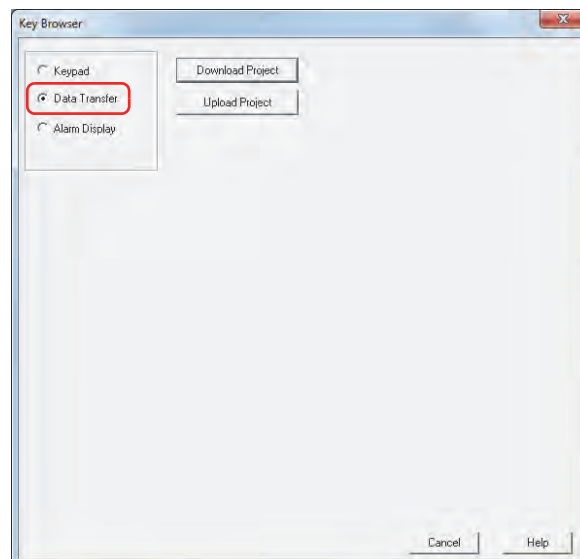

■ Alarm Display

These buttons are used to manipulate the Alarm List Display and Alarm Log Display parts.

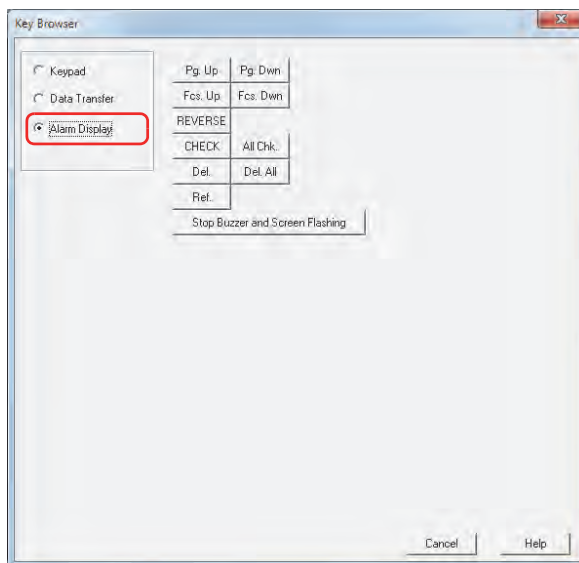

5 Multi-Button

5.1 How the Multi-Button is Used

Executes multiple commands at once.

These commands can be assigned to a Multi-Button.

Command	Description
Bit Write	Writes a 0 or 1 to the specified bit device when pressed.
Word Write	Writes a value to a word device when pressed. You can specify the destination address indirectly, and perform arithmetic on the value to be written.
Goto Screen	Switches screens or opens other windows when pressed.
Key	Performs downloads or uploads when pressed. Also used to manipulate other parts.
Script	Executes a script when pressed.

- Pressing the button writes a 1 to a bit device, and the value in a word device to another device.

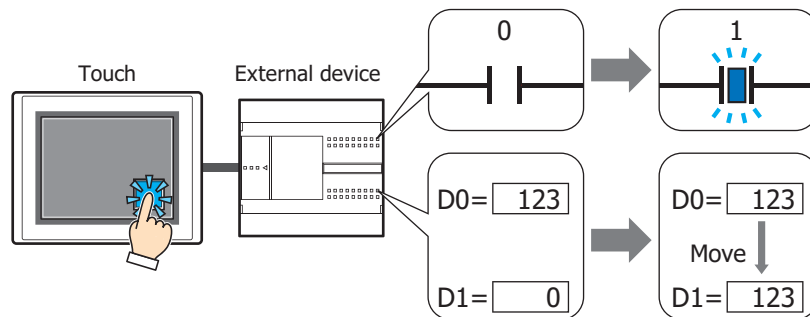

- When the button is pressed, executes the script and switches the Base Screen

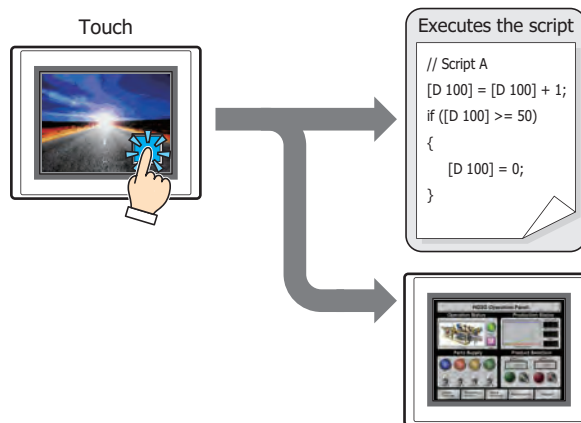

5.2 Multi-Button Configuration Procedure

This section describes the configuration procedure for Multi-Buttons.

- 1 On the **Home** tab, in the **Parts** group, click **Buttons**, and then click **Multi-Button**.

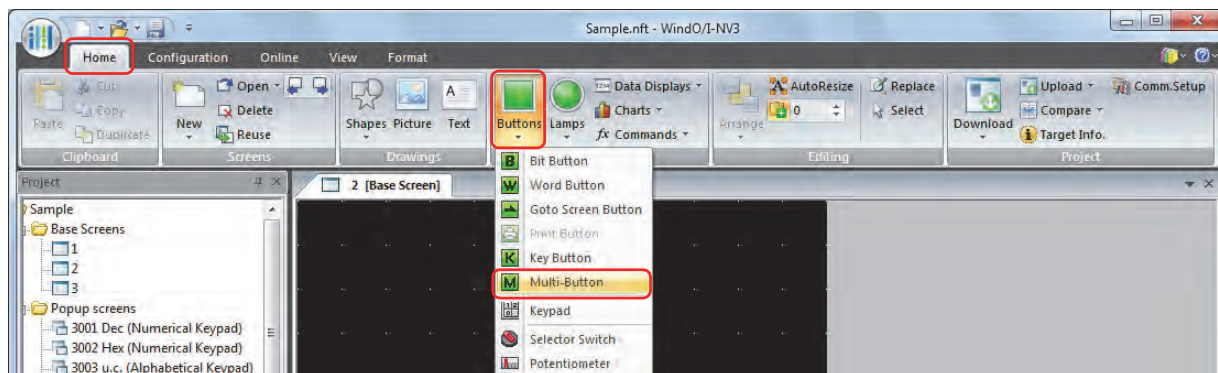

- 2 Click a point on the edit screen where you want to place the Multi-Button.
- 3 Double-click the dropped Multi-Button and a Properties dialog box will be displayed.
- 4 Change the settings on each tab as necessary.

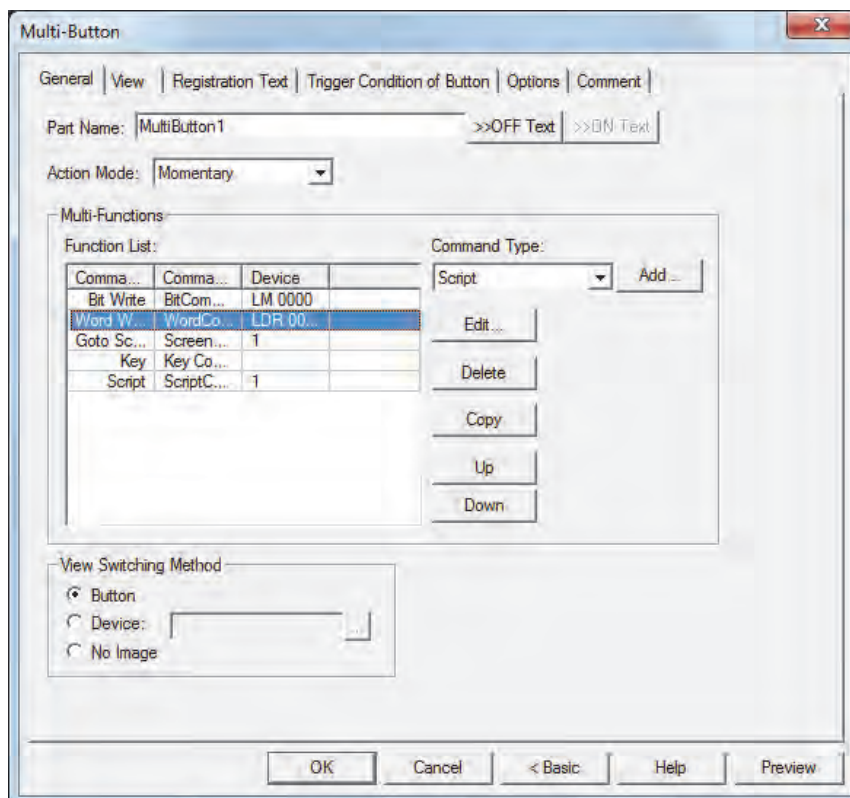

The **Trigger Condition** tab and **Options** tab only appear in Advanced mode.

To switch to Advanced mode, click **Advanced**.

5.3 Properties of Multi-Button Dialog Box

This section describes items and buttons in the Properties dialog box.

● General Tab

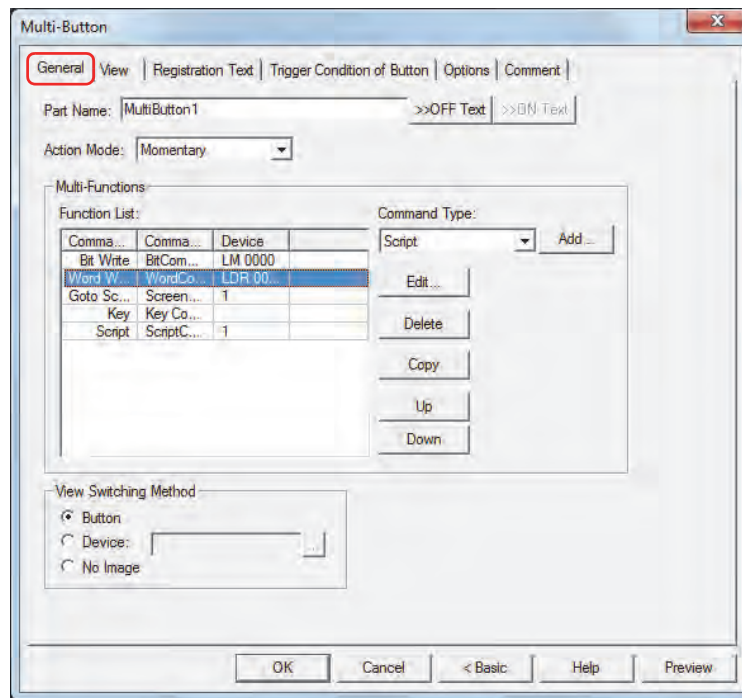

■ Part Name

Enter a name for the part. The maximum number is 20 characters.

■ >>OFF Text, >>ON Text

Applies the text entered in the **Part Name** field to the **Text** field under the **OFF** or **ON** fields on the **Registration Text** tab. This is used as the Registration Text when the button is OFF or ON.



To specify the Registration Text to use when the button is ON, select the **Set by State** check box on the **Registration Text** tab. If left unchecked, the same Registration Text assigned for the OFF state is displayed for the ON state as well.

■ Action Mode

Select the **Action Mode** for the Multi-Button: **Momentary** or **Alternate**.

Momentary: The button turns ON when pressed, and OFF when released.

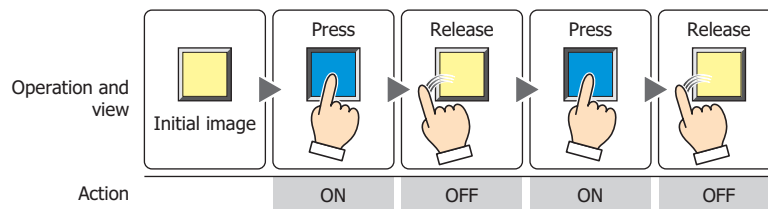

Alternate: The button switches between ON and OFF each time it is pressed.

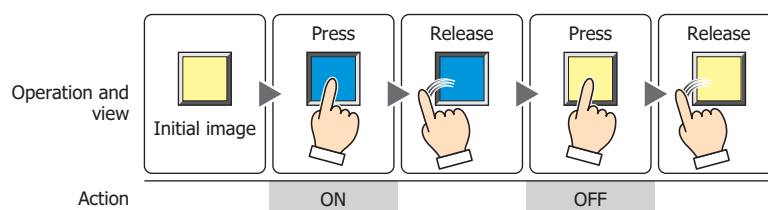

■ Multi-Function

Use this grid to add or edit commands to execute when the Multi-Button is pressed.

Function List:	Lists the commands to be executed.
Command Type:	Shows the command type.
Command Name:	Shows the command name.
Device:	Shows the setting when one of the following Command Type is selected. Shows the destination device for the Bit Write and Word Write commands. Shows the screen number when Goto Screen is set to Switch to Base Screen, Open Popup Screen, or Close Popup Screen . Shows the script ID for the Script command.



- Executes only the Goto Screen command at the end of the **Function List** when multiple **Switch to Base Screen** type commands are set for **Action Mode**.
- Goto Screen commands are not executed from top to bottom as they appear in the **Function List**. Rather, they are executed at the end of the scan of the Touch when the Multi-Button is pressed.
- If multiple Key commands are set, only the first and second Key commands in the **Function List** are executed. The third and following Key commands are not executed. Also, only the first Key command that specifies a Data Transfer function in the **Function List** is executed if multiple Key commands are set.
- The function of Key command will affect on the next scan when the trigger condition is satisfied.

Command Type: Select the command to add.

Bit Write:	Writes a 0 or 1 to the bit device or bit of the word device. For details, refer to "Properties of Bit Write for Multi-Functions dialog box" on page 7-73.
Word Write:	Writes a value to a word device. Can be used to indirectly specify the destination address or to perform operations on the written value. For details, refer to "Properties of Word Write for Multi-Functions dialog box" on page 7-74.
Goto Screen:	Switches to another screen or displays a window. For details, refer to "Properties of Goto Screen for Multi-Functions dialog box" on page 7-76.
Key:	Performs a variety of functions including uploading and downloading, copying files, and operating other parts. For details, refer to "Properties of Key for Multi-Functions dialog box" on page 7-78.
Script:	Executes the script. For details, refer to "Properties of Script for Multi-Functions dialog box" on page 7-80.

Add: Adds a command to the list. A maximum of 32 commands may be added.

Click this button to display the Properties dialog box for the command selected from **Command Type**.

Edit: Changes a command in the list.

Click this button to display the Properties dialog box for the command selected in **Function List**.

Delete: Deletes a command from the list.

Select the command in the list, and then click this button.

Copy: Copies a command in the list.

Select a command in the list, and then click this button. A copy of the selected command is added to the end of the list.

Up: Shifts the selected command upward in the list.

Down: Shifts the selected command downward in the list.

■ View Switching Method*1

Select how to display the ON/OFF status of the button.

Button: Pressing the button changes the drawing object displayed.

Device: The drawing objects assigned to the OFF and ON states are displayed when the value of device is 0 and 1, respectively. Specifies the device used to switch the drawing object display.

Click  to display the Device Address Settings dialog box. For the device address configuration procedure, refer to Chapter 2 "5.1 Device Address Settings" on page 2-61.

No Image: The button is not displayed on the screen. The button appears as a dashed line frame on the edit screen. Pressing the corresponding area on the Touch activates the assigned function. If **No Image** is selected, the settings for View and Registration Text are disabled.



Selecting **Device** in **View Switching Method** allows you to create an illuminated pushbutton.

The illuminated pushbutton switches state (or image) according to ON or OFF state of the device address, allowing you to display the state of a device that is being operated.

Example: When you set an external device address M0 as **Device** in **View Switching Method**, if the value of M0 changes, the display image will be switched according to the value of M0 even if the button is not pressed.

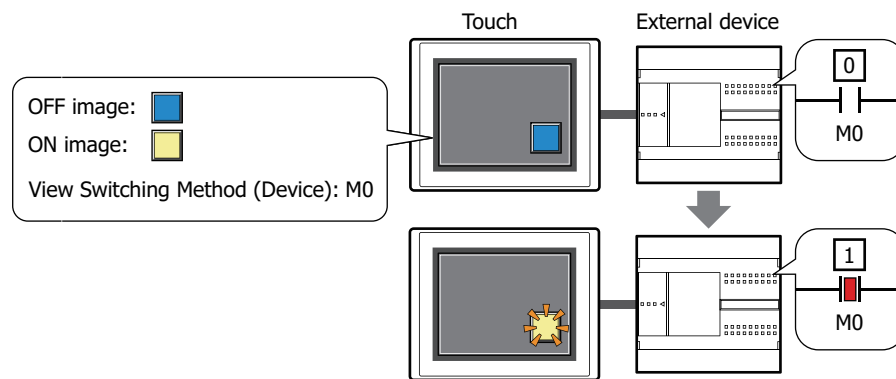

*1 Advanced mode only

Properties of Bit Write for Multi-Functions dialog box

Sets the Bit Write command for the Multi-Button.

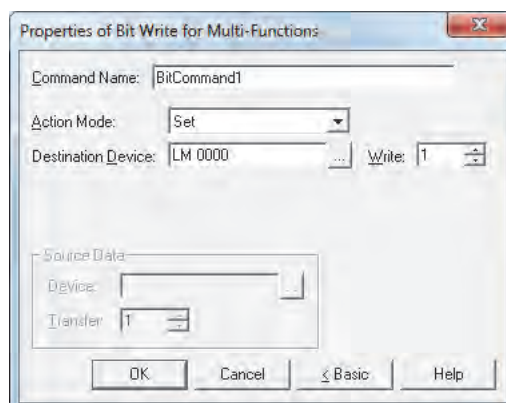

■ Command Name

Enter a name for the command. The maximum number is 20 characters.

■ Action Mode

Select the behavior of the Multi-Button from the following:

- Set: Pressing the button writes a 1 to the bit device.
- Reset: Pressing the button writes a 0 to the bit device.
- Set & Reset: Pressing the button writes a 1 to the bit device.
Releasing the button writes a 0 to the bit device.
- Toggle: Pressing the button inverts the value of the bit device.
If the value of the bit device is 0 it changes to 1, and vice versa.
- Move: Pressing the button writes the value in the source bit device to the value in the destination bit device.



For details about the **Action Mode**, refer to “Action Mode” on page 7-4. However, **Set & Reset** for the Multi-Button has the same function as **Momentary** for the Bit Button.

■ Destination Device

Specify the destination bit device.

Click to display the Device Address Settings dialog box. For the device address configuration procedure, refer to Chapter 2 “5.1 Device Address Settings” on page 2-61.

■ Write*1

Specify the number of bit devices (1 to 64) at the destination.

This setting is enabled only if **Action Mode** is set to **Set** or **Reset**. For details, refer to “Write” on page 7-6.

■ Source Data

Specifies the device that stores the data to be written.

This setting is enabled only if **Action Mode** is set to **Move**. For details, refer to “Source Data” on page 7-6.

Device: Specify the source bit device.

Click to display the Device Address Settings dialog box. For the device address configuration procedure, refer to Chapter 2 “5.1 Device Address Settings” on page 2-61.

Transfer: Specify the number of bit devices (1 to 64) to transfer.

*1 Advanced mode only

Properties of Word Write for Multi-Functions dialog box

Sets the Word Write command for the Multi-Button.

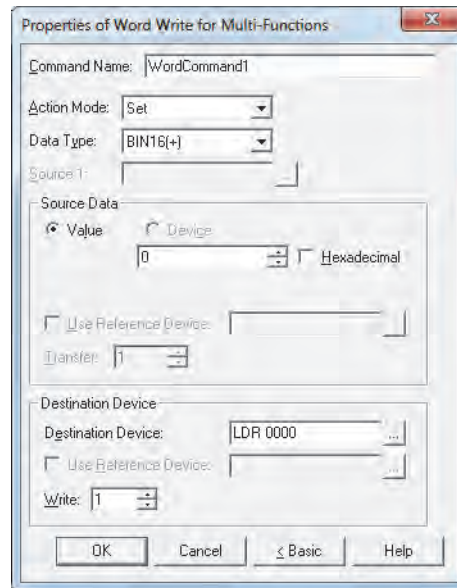

■ Command Name

Enter a name for the command. The maximum number is 20 characters.

■ Action Mode

Select the behavior of the Multi-Button from the following:

- Set: Pressing the button writes a constant value to a word device.
- Move: Pressing the button writes the value in the source device to the destination word device.
- Set ON & OFF Data: Pressing the button writes the constant value of ON data to a word device.
Releasing the button writes the constant value of OFF data to a word device.
- Add, Sub, Multi, Div, Mod, OR, AND, XOR:
Pressing the button performs arithmetic on the value in a reference device and a constant value or the value in a device address and writes the result to a word device.



For details about the **Action Mode**, refer to "Action Mode" on page 7-21. However, **Set ON & OFF Data** for the Multi-Button has the same function as **Momentary** for the Word Button.

■ Data Type

Select the data type handled by the operation selected for **Action Mode**.

For details, refer to Chapter 2 "1.1 Available Data" on page 2-1.

BIN16(+) and **BIN32(+)** can only be set if **Action Mode** is set to **OR**, **AND**, or **XOR**.



BIN16(+) and **BIN32(+)** can only be set if **Action Mode** is set to **Move**. Because the number of devices to transfer is specified in Advanced mode, you do not need to set Data Type.



If **BCD4**, **BCD8** or **float32** is selected and the arithmetic data contains a value inexpressible in BCD, a 1 is written to System Area 2 Arithmetic error bit (address+2, bit 5) and an error message is displayed.
For details, refer to Chapter 3 "Arithmetic error" on page 3-25.

■ Source 1

Specify the source word device.

Click  to display the Device Address Settings dialog box. For the device address configuration procedure, refer to Chapter 2 "5.1 Device Address Settings" on page 2-61.

This setting is enabled only if **Action Mode** is set to **Add**, **Sub**, **Multi**, **Div**, **Mod**, **OR**, **AND**, or **XOR**.

■ Source Data

Select the data handled by the operation selected for **Action Mode**.

Value: Use a constant.

Only a **Value** can be handled if **Action Mode** is set to **Set** or **Set ON & OFF Data**.

If **Action Mode** is set to **Set ON & OFF Data**, the value in the **ON Data** is written when the button is ON, and the value in the **OFF Data** is written when the button is OFF.

Hexadecimal: Select this check box to enter the **ON Data** and **OFF Data** values in hexadecimal.

Device: Use a word device.

Specify the device.

Click to display the Device Address Settings dialog box. For the device address configuration procedure, refer to Chapter 2 "5.1 Device Address Settings" on page 2-61.

Use Reference Device^{*1}: Select this check box and specify a device to change the source word device according to the value of the specified device.

This setting is enabled only if **Action Mode** is set to **Move**.

For details, refer to Chapter 2 "Indirect Read and Indirect Write Settings" on page 2-4.

Transfer^{*1}: Specify the number of word devices (1 to 64) to transfer.

This setting is enabled only if **Action Mode** is set to **Move**.

For details, refer to "Transfer" on page 7-23.

■ Destination Device

Destination Device: Specify the destination word device.

Click to display the Device Address Settings dialog box. For the device address configuration procedure, refer to Chapter 2 "5.1 Device Address Settings" on page 2-61.

Use Reference Device^{*1}: Select this check box and specify a device to change the destination word device according to the value of the specified device.

This setting is enabled only if **Action Mode** is set to **Move**.

For details, refer to Chapter 2 "Indirect Read and Indirect Write Settings" on page 2-4.

Write^{*1}: Specify the number of word devices (1 to 64) at the destination.

For **Move**, specify how many times to write.

This setting is enabled only if **Action Mode** is set to **Set**, **Move**, or **Set ON & OFF Data**.

For details, refer to "Write" on page 7-24.

*1 Advanced mode only

Properties of Goto Screen for Multi-Functions dialog box

Sets the Goto Screen command for the Multi-Button.

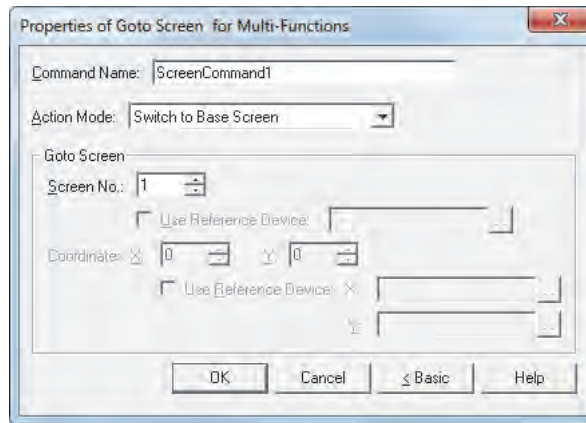

■ Command Name

Enter a name for the command. The maximum number is 20 characters.

■ Action Mode

Select the behavior of the Multi-Button from the following:

Back to previous Screen:	Switches to the previous screen. Returns to up to 16 earlier screens.
Switch to Base Screen:	Switches between Base Screen.
Open Popup Screen:	Opens a Popup Screen.
Close Popup Screen:	Closes a Popup Screen.
Open Device Monitor Screen:	Opens the Device Monitor Screen.
Close Device Monitor Screen:	Closes the Device Monitor Screen.
Open Ladder Monitor:	Opens the Ladder Monitor.
Close Ladder Monitor:	Closes the Ladder Monitor.
Open Password Screen:	Opens the Password Screen.
Close Password Screen:	Closes the Password Screen.
Open Adjust contrast Screen:	Opens the Adjust contrast Screen.
Close Adjust contrast Screen:	Closes the Adjust contrast Screen.
Switch to System Mode:	Switches to the Top Page in the System Mode.
Reset current screen:	Resets the current Base Screen.



- **Open Ladder Monitor** and **Close Ladder Monitor** can only operate when ladder program is selected as the programming language in control function.
- When the current Base Screen is reset using the **Reset current screen** function, the window and internal devices restart as if the Base Screens were switched.

■ Goto Screen

Screen No.: If **Action Mode** is set to **Switch to Base Screen**, specify the Base Screen number to switch to (from 1 to 3,000). If **Action Mode** is set to **Open Popup Screen** or **Close Popup Screen**, specify the number of the Popup Screen to open or close (from 1 to 3,015).

This setting is enabled only if **Action Mode** is set to **Switch to Base Screen**, **Open Popup Screen**, or **Close Popup Screen**.

Use Reference Device^{*1}: Select this check box and specify a device to specify the screen number using the value of the specified device.

Click  to display the Device Address Settings dialog box. For the device address configuration procedure, refer to Chapter 2 "5.1 Device Address Settings" on page 2-61.

This setting is enabled only if **Action Mode** is set to **Open Popup Screen** or **Close Popup Screen**.

Coordinates X, Y: Specify the coordinates on the Base Screen for displaying a window.

X and Y specify the upper left corner of the window using the upper left corner of the screen as the origin.

This setting is enabled only if **Action Mode** is set to **Open Popup Screen**, **Open Device Monitor Screen**, **Open Password Screen**, **Open Adjust contrast Screen**, or **Open Movie File Screen**.

Use Reference Device^{*1}: Select this check box and specify a device to specify the coordinates using the value of the specified device.

Click  to display the Device Address Settings dialog box. For the device address configuration procedure, refer to Chapter 2 "5.1 Device Address Settings" on page 2-61.

This setting is enabled only if **Action Mode** is set to **Open Popup Screen**.



With the HG2F/2S/3F/4F, window display coordinates are automatically adjusted to a position in multiples of 20 dots.

*1 Advanced mode only

Properties of Key for Multi-Functions dialog box

Sets the Key command for the Multi-Button.

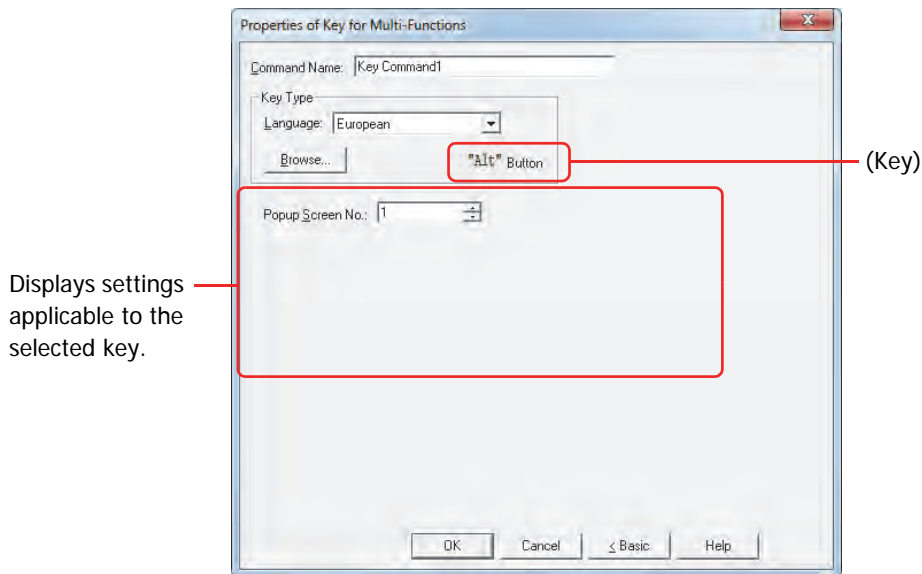

■ Command Name

Enter a name for the command. The maximum number is 20 characters.

■ Key Type

Select the function for the Key command.

Language: Switches the display of the key that is displayed when **Keypad** is selected in Key Browser. These languages are available:

Japanese, European, Central European, Baltic, Cyrillic.

Browse: Opens the Key Browser when clicked. Select a key.
For details, refer to "4.5 Key Browser" on page 7-66.

(Key): Displays the name of the key selected using the Key Browser.



- When you select a key, the label for that key is assigned as the Registration Text.
- The function of Key command will affect on the next scan when the trigger condition is satisfied.

The settings explained below appear depending on the type of key selected.

■ Popup Screen No.

The **Alt** key switches the current Popup Screen used as a Keypad when this button is pressed.

Specify the Popup Screen number to open a Keypad for.

This setting is enabled only if **Alt** was selected using the Key Browser.

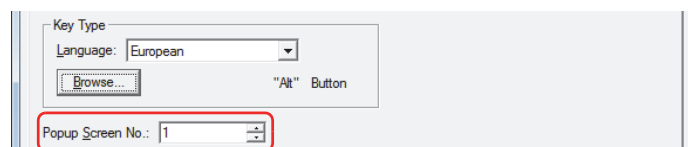

■ Scroll Size

Key Buttons **Pg. Up** and **Pg. Dwn** scroll the list up and down, respectively. Key Buttons **Fcs. Up** and **Fcs. Dwn** move the focus up and down, respectively. This settings specifies the number of pages or lines (1 to 1023 lines) to scroll or move the focus per each press of the button.

This setting is enabled only if **Pg. Up, Pg. Dwn, Fcs. Up, and Fcs. Dwn** are selected using the Key Browser.

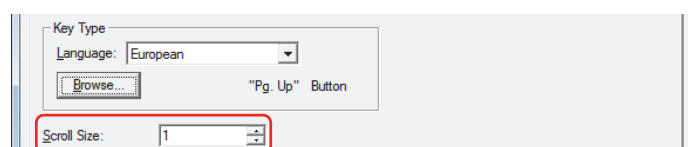

■ Transfer Setting

Key commands **Download Project** and **Upload Project** perform the data transfer function specified by their names.

These settings specify the source, data to be transferred, and destination.

This setting is enabled only if one of these keys is selected after clicking **Data Transfer** in the Key Browser.

If **Download Project** is selected.

The screenshot shows a dialog box for the 'Download Project' button. At the top, there is a 'Key Type' section with a 'Language' dropdown set to 'European' and a 'Browse...' button. Below this is the 'Transfer Setting' section, which is highlighted with a red border. It contains three fields: 'Source' (dropdown menu set to 'USB Flash Drive'), 'Path' (text input field), and 'Destination' (dropdown menu set to 'FT1A').

Source: This is set to the USB flash drive on which the project file to transfer (.ZNV) was saved.

File Path: Specify the path to the project file (.ZNV) to transfer. The maximum number is 247 characters.

Example: Where "FT_DEMO_1.ZNV" is a project file saved on the root directory of a USB flash drive:

FT_DEMO_1.ZNV

If **Upload Project** is selected.

The screenshot shows a dialog box for the 'Upload Project' button. At the top, there is a 'Key Type' section with a 'Language' dropdown set to 'European' and a 'Browse...' button. Below this is the 'Transfer Setting' section, which is highlighted with a red border. It contains four fields: 'Source' (dropdown menu set to 'FT1A'), 'Path' (text input field containing 'Sample05.ZNV'), 'Destination' (dropdown menu set to 'USB Flash Drive'), and 'Folder Path' (text input field).

Source: Specify where to save the project uploaded from Touch. The location is the USB flash drive.

File Path: Specify the path to the folder where the uploaded project file will be saved. The maximum number is 247 characters.

Example: To save it to the folder "Uploaded_Project" on a USB flash drive:

Uploaded_Project

Properties of Script for Multi-Functions dialog box

Sets the script command for the Multi-Button.

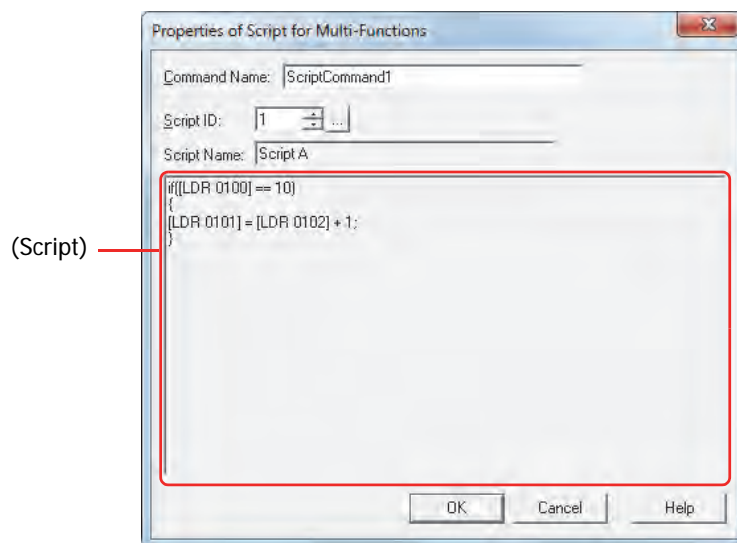

- **Command Name**

Enter a name for the command. The maximum number is 20 characters.

- **Script ID**

Specify the script ID (1 to 32,000) of the script to operate.

Script Manager will open when is clicked. Select a script from the script list.

For details, refer to Chapter 20 "2.2 Script Manager" on page 20-7.

- **Script Name**

Displays the name of the script selected in Script Manager.

- **(Script)**

Displays the contents of the script selected in Script Manager.

Once this area is double clicked, the Script Editor will open and editing can be done.

For details, refer to Chapter 20 "2.3 Script Editor" on page 20-8.

● View Tab

Only **Coordinates** and **Size** can be configured when **No Image** is selected for **View Switching Method** on the **General** tab.

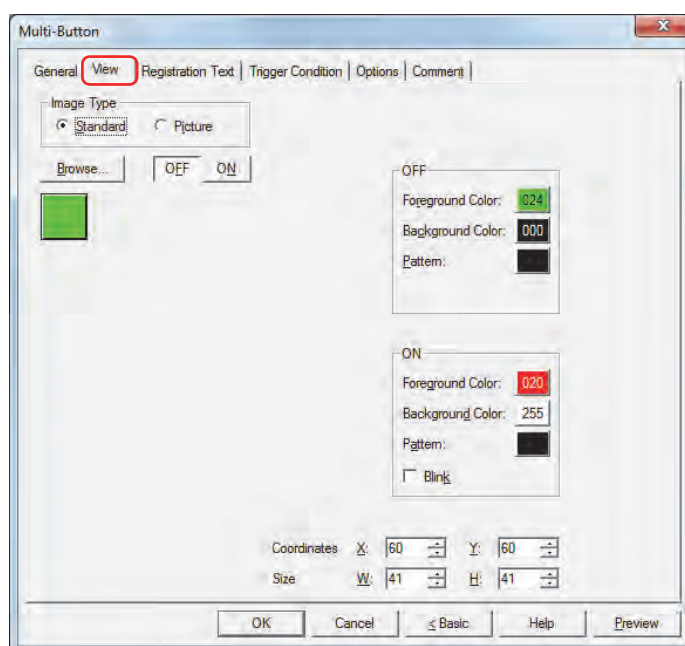

■ Image Type

Select the type of graphic to be used to represent the part.

Standard: Uses the default graphics contained within WindO/I-NV3.

Picture: Uses an image file saved in Picture Manager.

For details about image file restrictions, refer to Chapter 2 "1.4 Available Image Files" on page 2-18.

■ Browse

Select the type of graphic to be used to represent the part from the list of graphics. Click this button to display the View Browser or Picture Manager, depending on the setting for **Image Type**.

■ OFF button, ON button

Displays the graphic when ON or OFF. Clicking the **ON** button or **OFF** button switches the image displayed on the **View** tab.

■ OFF, ON

Selects the color and pattern of the standard graphic when ON and OFF.

Foreground Color, Background Color:

Selects the foreground and background colors of the standard graphic (color: 256 colors, monochrome: 8 shades).

Click the **Color** button to display the Color Palette. Select a color from the Color Palette.

Pattern: Selects a pattern for the standard graphic.

Click the **Pattern** button to display the Pattern Palette. Select a pattern from the Pattern Palette.

■ Blink

Select this check box if blinking is desired (alternating ON and OFF) when a part is ON.

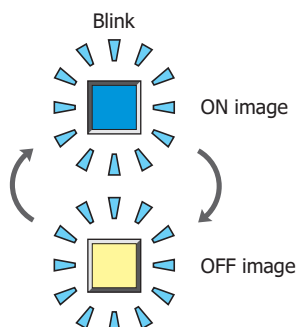

■ Coordinates

X, Y: Sets the display position of parts using coordinates.

The X and Y coordinates of parts are defined relative to an origin at the top-left corner of the screen.

X: 0 to (Base Screen horizontal size - 1)

Y: 0 to (Base Screen vertical size - 1)

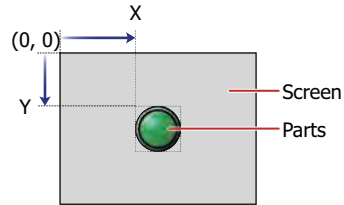

■ Size

W, H: Sets width and height to define the size of parts.

W: 20 to (Base Screen horizontal size)

H: 20 to (Base Screen vertical size)

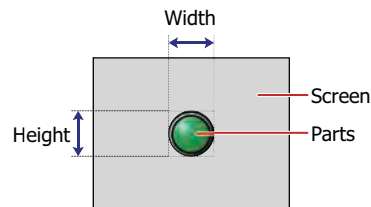

● Registration Text Tab

These options can only be configured when **Button** or **Device** is selected for **View Switching Method** on the **General** tab.

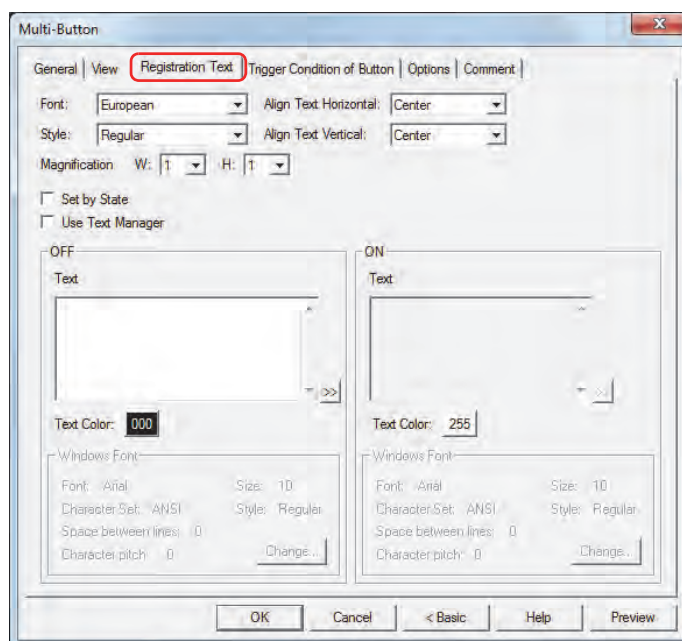

■ Font

Selects the font used for displaying text from the following.

Japanese, European, Chinese, Taiwanese, Korean, Central European, Baltic, Cyrillic, Windows

Can only be set when the **Use Text Manager** check box is cleared.

The characters that can be displayed depend on the font. For details, refer to Chapter 2 "1.2 Available Text" on page 2-5.

■ Style

Selects **Regular** or **Bold** for text style.

Can only be set when **Font** is set to **Japanese, European, Chinese, Taiwanese, Korean, Central European, Baltic** or **Cyrillic**.

■ Magnification

W, H: Selects the magnification (0.5, 1 to 8) for text display.

Can only be set when **Font** is set to **Japanese, European, Chinese, Taiwanese, Korean, Central European, Baltic** or **Cyrillic**.

■ Align Text Vertical

Selects text alignment in the vertical direction.

Top, Center, Bottom

For details, refer to Appendix "5 Text Alignment" on page A-5.

■ Align Text Horizontal

Selects text alignment in the horizontal direction.

Left, Center, Right, Center-Left

For details, refer to Appendix "5 Text Alignment" on page A-5.

■ Set by State

Select this check box if displaying different text when ON and OFF.

■ Use Text Manager

Select this check box if using the text registered in Text Manager for text display.

■ OFF, ON

Text: Inputs characters to be displayed on parts. The maximum number is 3,750 characters.
The characters that can be entered depend on the font selected using **Font**. For details, refer to Chapter 2 "1.2 Available Text" on page 2-5.



When entering Unicode characters click  to display the Unicode Input dialog box. Enter the characters using the Unicode Input dialog box then click **OK**.

Text ID: Specifies the Text Manager ID No. (1 to 32000) when using the text registered in Text Manager.
Click  to display Text Manager.
Can only be set when the **Use Text Manager** check box is selected.

Text Color: Selects the color of the text displayed on the part (color: 256 colors, monochrome: 8 shades).
Click the **Color** button to display the Color Palette. Select a color from the Color Palette.

Windows Font: Sets the font to be used as the Windows Font.
Select **Windows** using **Font** to display the current setting. To change the setting, click **Change** to display the Font dialog box.
Can only be set when the **Use Text Manager** check box is cleared.
For details, refer to Chapter 2 "Windows Font" on page 2-12.

● Trigger Condition Tab

The **Trigger Condition** tab is displayed in Advanced mode.

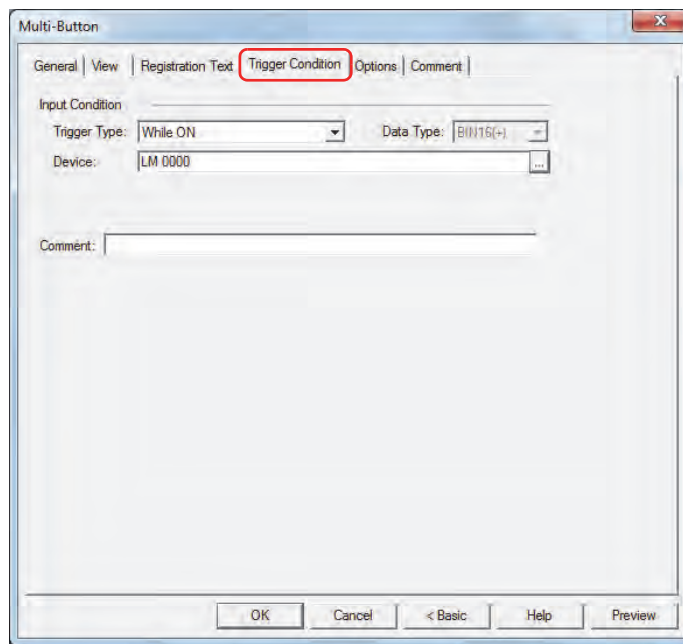

■ Input Condition

The Button is enabled and operational while the condition is satisfied. The Button is disabled and not operational while the condition is not satisfied.

Example: When **Trigger Type** is **While ON** and **Device** is LM0

While LM0 is 0, the condition is not satisfied and the Button is not operational.

While LM0 is 1, the condition is satisfied and the Button is operational.

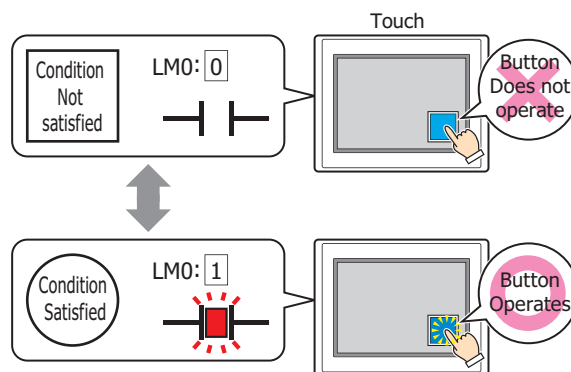

Trigger Type: Selects the condition to enable the Button from the following.

Always Enabled: The Button is always enabled.



While ON: Enables the Button when the value of device is 1.

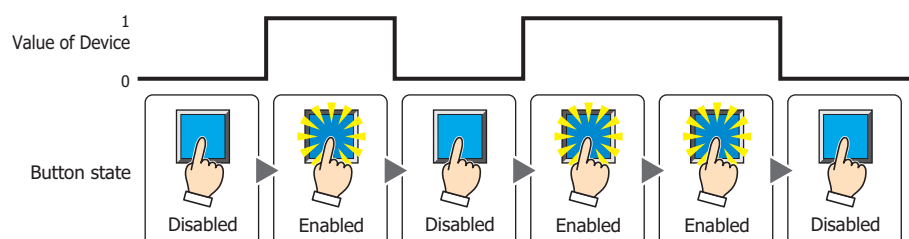

While OFF: Enables the Button when the value of device is 0.

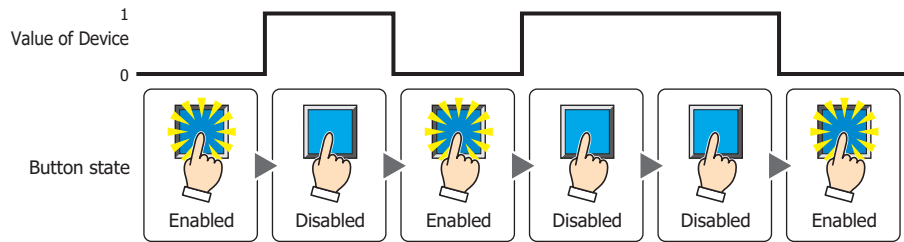

While satisfying the condition:

Enables the Button when the condition is satisfied.

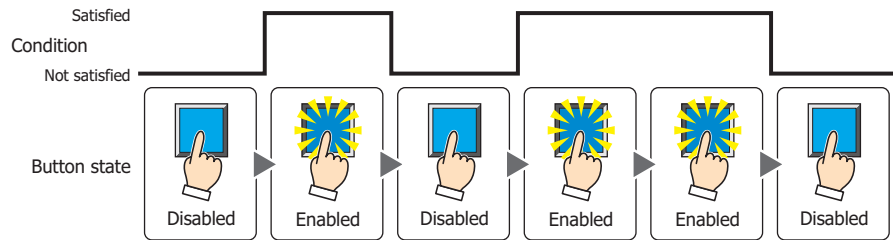

Data Type: Selects the type of data handled by the conditional expression for the input condition. This option can only be configured if **While satisfying the condition** is selected for **Trigger Type**. For details, refer to Chapter 2 “1.1 Available Data” on page 2-1.

Device: Specifies the bit device or bit of the word device to serve as the input condition. This option can only be configured when **While ON** or **While OFF** is selected for **Trigger Type**.

Click to display the Device Address Settings dialog box. For the device address configuration procedure, refer to Chapter 2 “5.1 Device Address Settings” on page 2-61.

Condition: Specifies the conditional expression for the input condition. This option can only be configured when **While satisfying the condition** is selected for **Trigger Type**.

Click to display the Trigger Condition Settings dialog box. For the conditional expression configuration procedure, refer to Chapter 2 “5.2 Setting Conditional Expressions” on page 2-63.

Comment: Enter a comment for the input condition. The maximum number is 80 characters.

● Options Tab

The **Options** tab is displayed in Advanced mode.

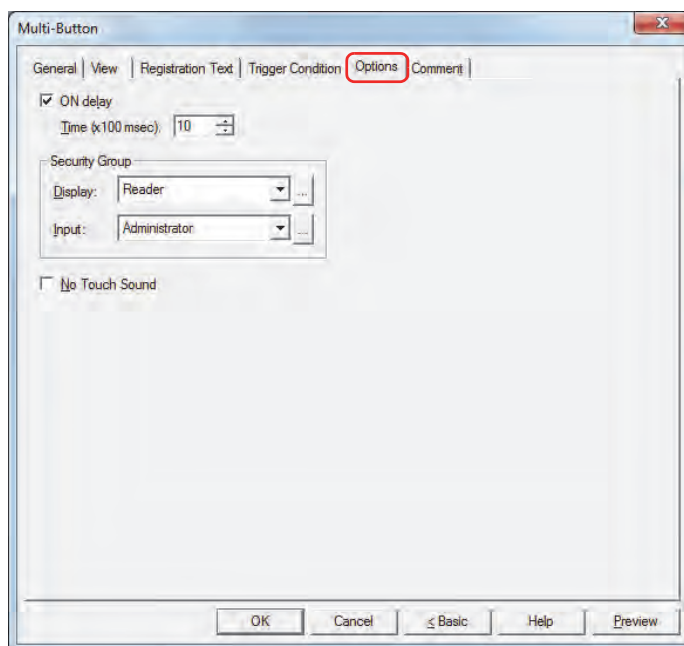

■ ON delay

Select this check box to use the ON delay function.

Time (x100 msec): Specify the length of time that the button must be held down before activation by selecting a value from 0 to 600 (units of 10 milliseconds).

The button activates after it is held down for a specified period of time.

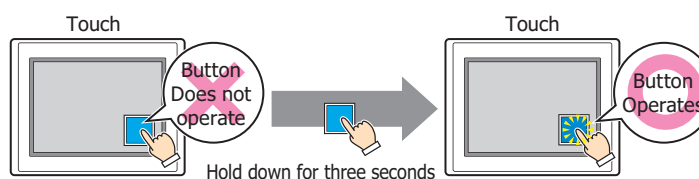

This feature protects against mistaken operation by ensuring that the button will not be activated if touched accidentally.

■ Security Group

Security groups are a security function for restricting the display and operation of parts.

Display: Selects the security group for which display of parts is restricted. (Default: None)

None: No security function is used.

Administrator, Operator, Reader: Three security groups are set up by default.

Click  to display the Security Group Settings dialog box. If you create a security group on the Security Group Settings dialog box, you can select that created group. For details, refer to Chapter 21 “2.2 Adding and Editing Security Groups” on page 21-15.

Input: Selects the security group for which operation of parts is restricted. (Default: None)

None: No security function is used.

Administrator, Operator, Reader: Three security groups are set up by default.

Click  to display the Security Group Settings dialog box. If you create a security group on the Security Group Settings dialog box, you can select that created group. For details, refer to Chapter 21 “2.2 Adding and Editing Security Groups” on page 21-15.



For details about security functions, refer to Chapter 21 “User Accounts and the Security Function” on page 21-1.

Example: If the user and security group for a part are set as follows:

User Name	 User1	 User2	 User3
Security Group	None	Group A	Group A, Group B

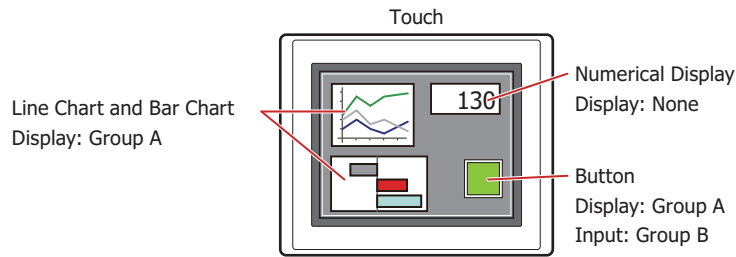

For User1, who is not included in the specified security group, Group A parts are not displayed. If the Password Screen is now opened and User2 logs in, Group A parts are displayed.

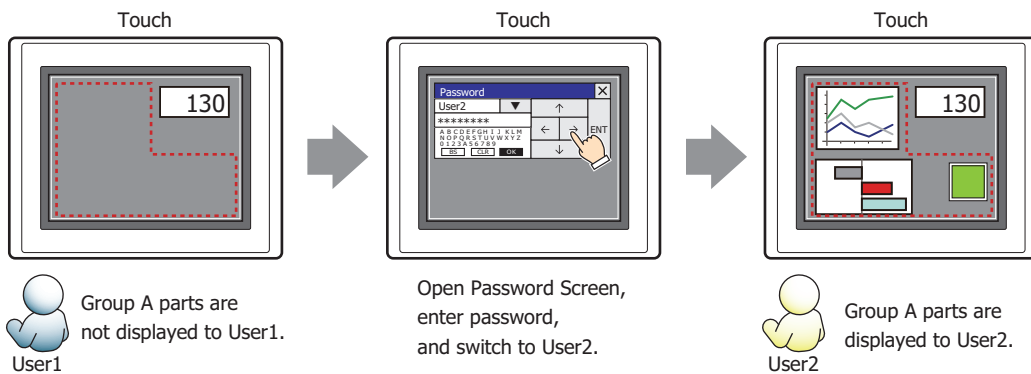

Since the display security group is Group A, User2 can view the buttons. But since the input security group is Group B, User2 cannot operate the buttons.

Suppose that the Password Screen is now opened and User3 logs in to the system. Group A buttons can be displayed, and Group B buttons can be operated.

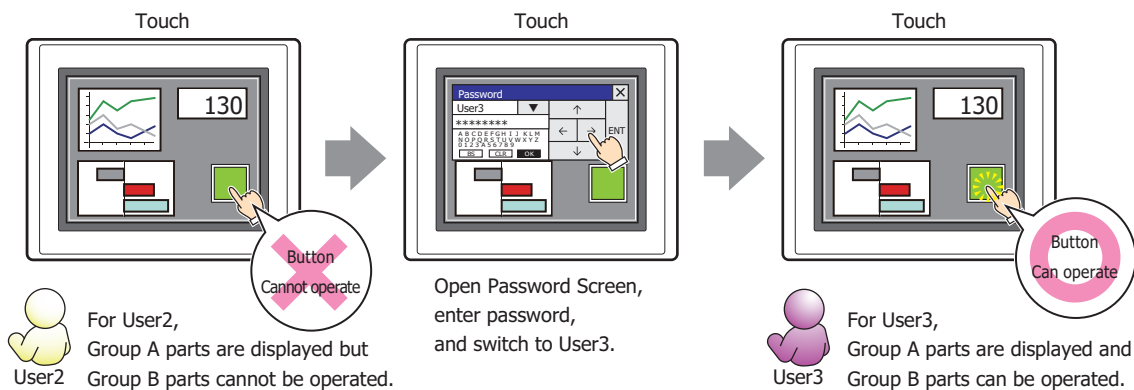

No Touch Sound

This function is to disable touch sounds only for specified parts when the Touch makes touch sounds. Select this check box to display disable touch sounds for this part.



To enable touch sounds on the Touch, select the **Enable Touch Sound** check box under the **System** tab of the Project Settings dialog box.

● Comment Tab

The **Comment** tab is used to specify the parts arranged on the editing screen, and the popup text displayed when the mouse pointer is placed close to **No.**, **Name**, or **Type** in the object list.



When there are multiple parts of the same shape on the screen, this features makes it possible to distinguish between the parts without displaying the Properties dialog box for each part, by just mousing over the part.

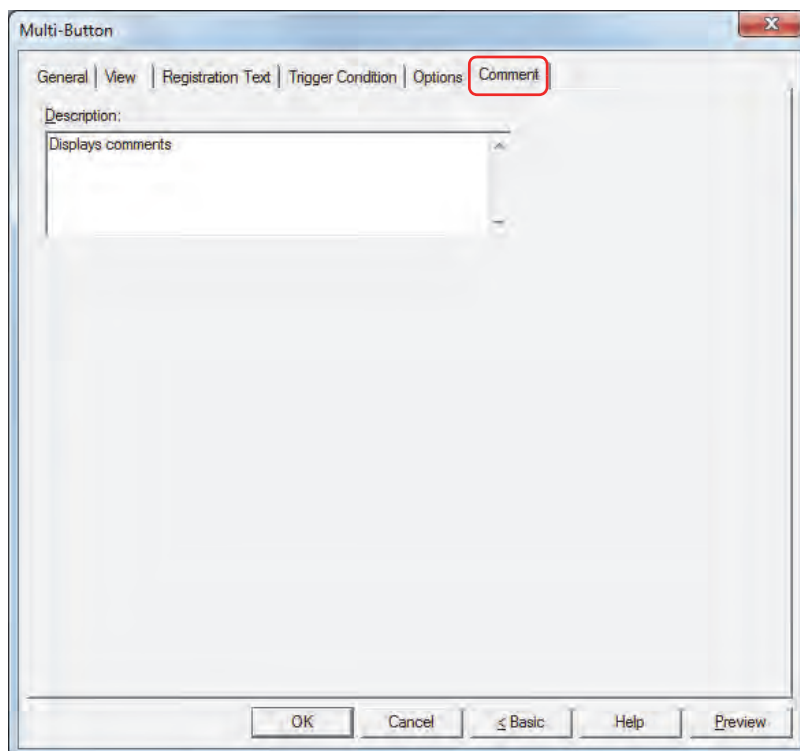

■ Description

Enter a comment about parts. The maximum number is 80 characters.

Example: When mousing over the Button on the editing screen

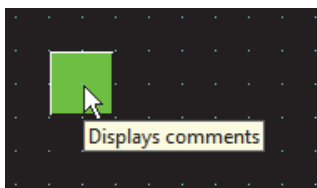

6 Keypad

6.1 How the Keypad is Used

A part comprised of Key Buttons. Enters numbers and characters into Numerical or Character Input parts.

- Entering numbers in the Numerical Input

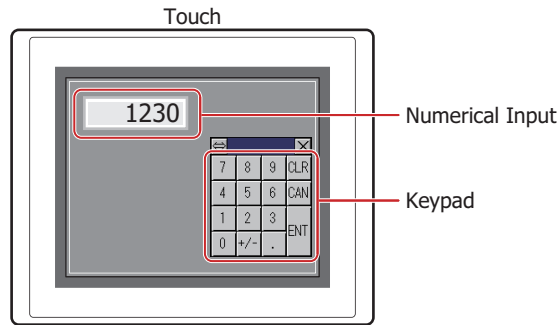

- Entering characters in the Character Input

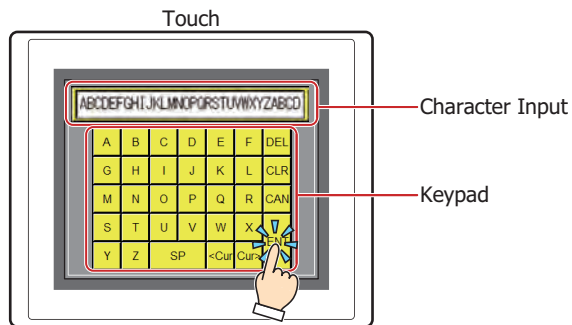

Do not use the Keypad part with the Goto Screen Button or a combination of Goto Screen Commands. For details, refer to "4 Key Button" on page 7-49.

6.2 Keypad Configuration Procedure

This section describes the configuration procedure for Keypads.

- 1 On the **Home** tab, in the **Parts** group, click **Buttons**, and then click **Keypad**.

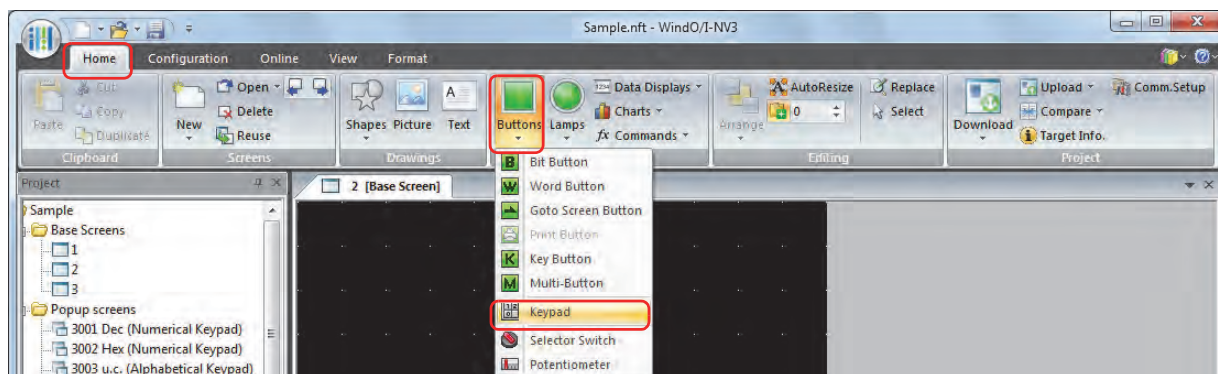

- 2 Click a point on the edit screen where you want to place the Keypad.
- 3 Double-click the dropped Keypad and a Properties dialog box will be displayed.
- 4 Change the settings on each tab as necessary.

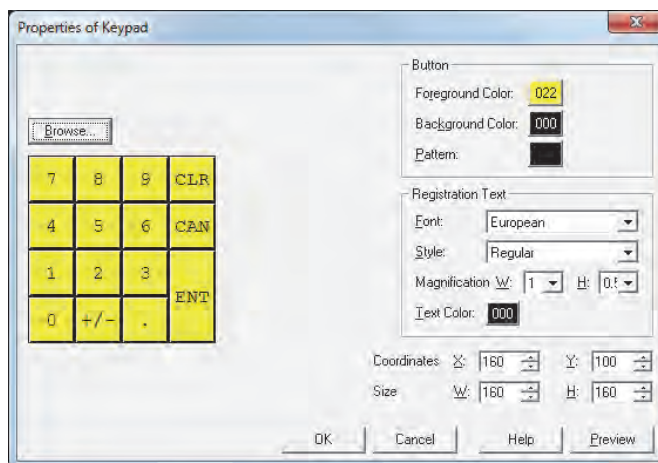

The Keypad Properties dialog box is displayed until **OK** is clicked.

☞ Refer to “6.3 Properties of Keypad Dialog Box” on page 7-92.



After **OK** on the Keypad Properties dialog box is clicked, double clicking the Keypad thereafter displays the Properties dialog box for the Key Buttons as a group.

This allows editing of settings common to each button.

- View: “View Tab” on page 7-54
- Registration Text: “Registration Text Tab” on page 7-56
- Options: “Options Tab” on page 7-60

The **Options** tab only appears in Advanced mode. To switch to Advanced mode, click **Advanced**.

6.3 Properties of Keypad Dialog Box

This section describes items and buttons in the Properties dialog box.

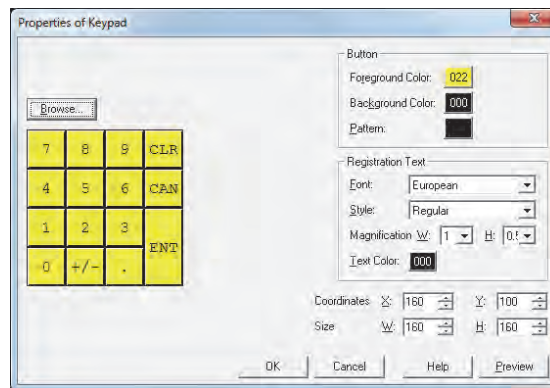

■ Browse

Select a prebuilt Keypad within WindO/I-NV3.

Displays the Standard Browser when clicked. Select numeric keys or character keys registered in the Standard Browser.

■ Button

Foreground Color, Background Color:

Select the foreground and background color to use for the Keypad (color: 256 colors, monochrome: 8 shades).

Displays the Color Palette when the **Color** button is clicked. Select a color from the Color Palette.

Pattern:

Select a pattern to use for the Keypad.

Displays the Pattern Palette when the **Pattern** button is clicked. Select a pattern from the Pattern Palette.

■ Registration Text

Font:

Select one of the following fonts to use for the text on the buttons.

Japanese, European, Chinese, Taiwanese, Korean, Central European, Baltic, Cyrillic.

The characters that can be displayed depend on the font. For details, refer to Chapter 2 "1.2 Available Text" on page 2-5.

Style:

Select a character style: **Regular** or **Bold**.

Magnification W, H: Select the zoom factor (0.5, 1 to 8) to use on the text.

This setting is only enabled when **Font** is set to **Japanese, European, Chinese, Taiwanese, Korean, Central European, Baltic** or **Cyrillic**.

Text Color:

Select the text color (color: 256 colors, monochrome: 8 shades).

Displays the Color Palette when the **Color** button is clicked. Select a color from the Color Palette.

■ Coordinates

X, Y:

Specify the display coordinates of the Keypad.

X and Y specify the upper left corner of the Keypad using the upper left corner of the screen as the origin.

X: 0 to (Base Screen horizontal size - 1)

Y: 0 to (Base Screen vertical size - 1)

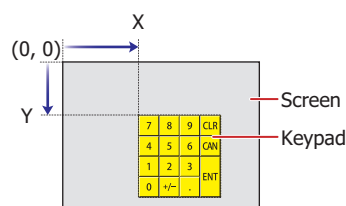

■ Size

W, H: Specify the size of the Keypad by specifying width and height.

W: 20 to (Base Screen horizontal size)

H: 20 to (Base Screen vertical size)

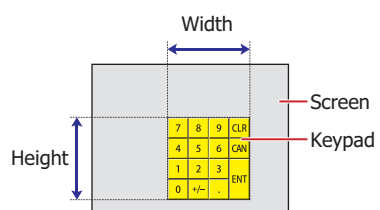

7 Selector Switch

7.1 How the Selector Switch is Used

Writes a 0 or 1 to a bit device. This is an exclusive control that only writes a single value as 1 and all other values as 0.

- Switching between two Run Modes (Manual and Auto)

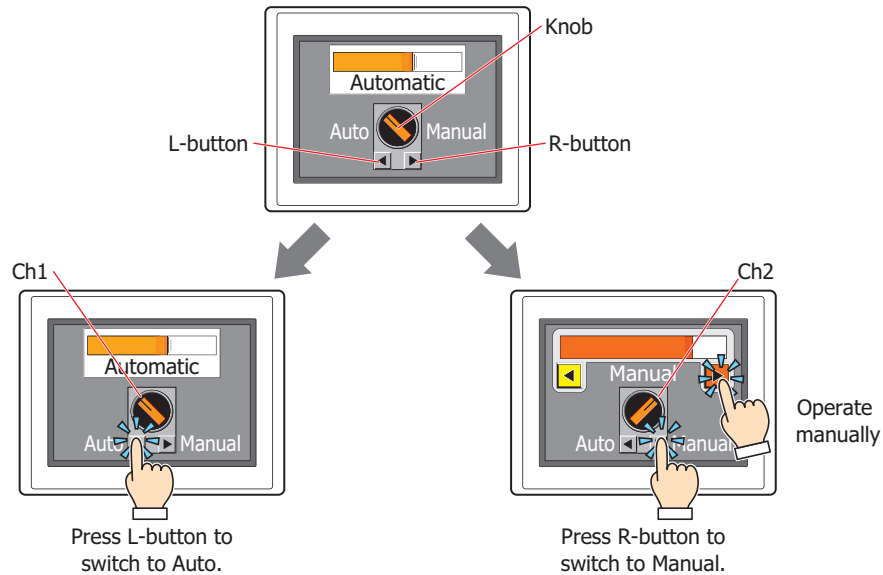

- Switching between three Run Modes (Filling - Stop - Discharge)

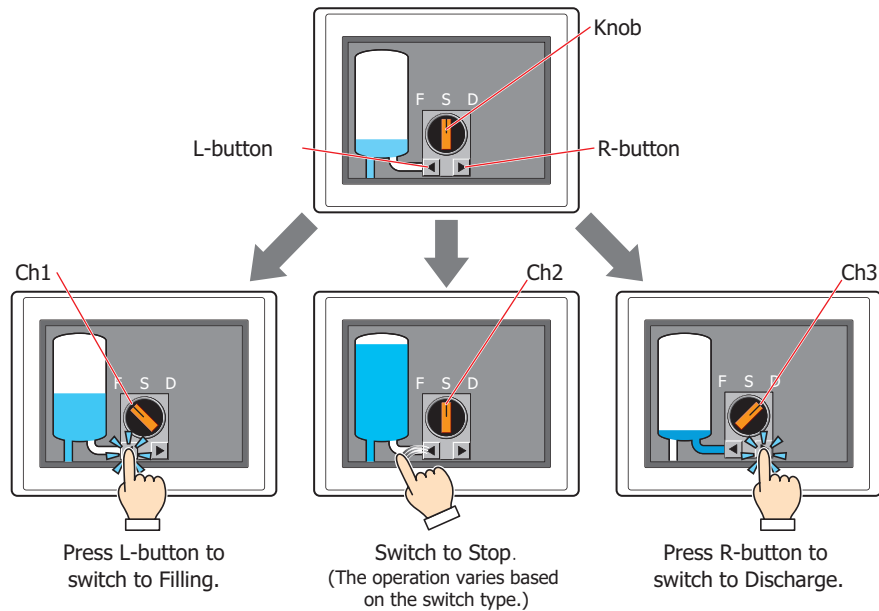

7.2 Selector Switch Configuration Procedure

This section describes the configuration procedure for Selector Switch buttons.

- 1 On the **Home** tab, in the **Parts** group, click **Buttons**, and then click **Selector Switch**.

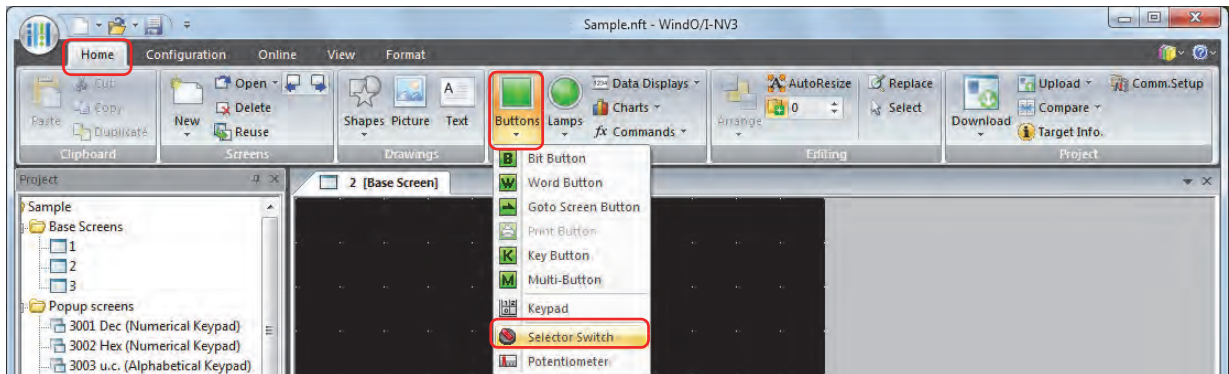

- 2 Click a point on the edit screen where you want to place the Selector Switch.
- 3 Double-click the dropped Selector Switch and a Properties dialog box will be displayed.
- 4 Change the settings on each tab as necessary.

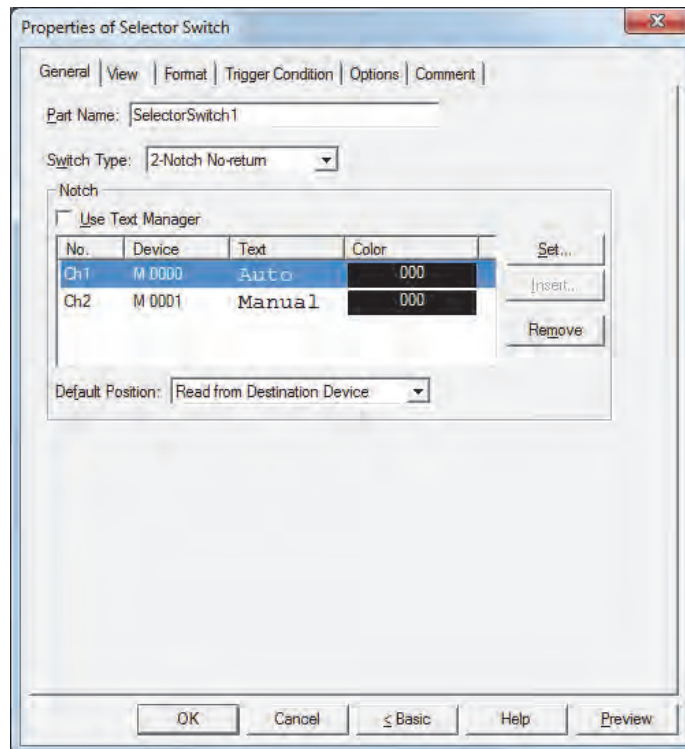

The **Trigger Condition** tab and **Options** tab only appear in **Advanced mode**. To switch to **Advanced mode**, click **Advanced**.

7.3 Properties of Selector Switch Dialog Box

This section describes items and buttons in the Properties dialog box.

● General Tab

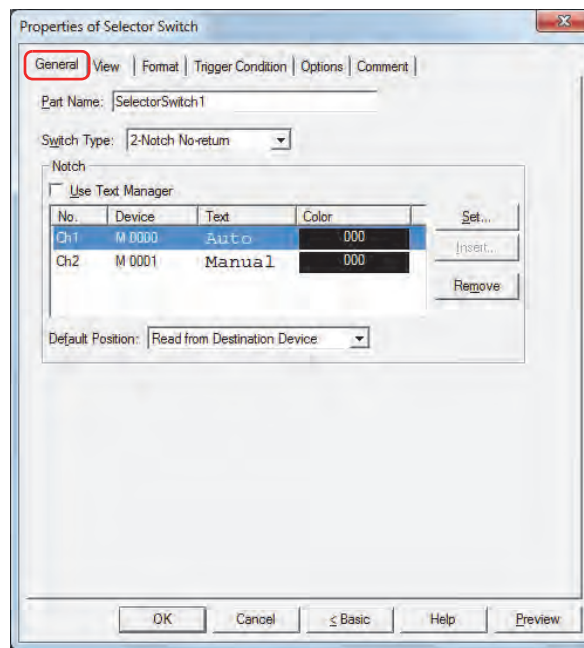

■ Part Name

Enter a name for the part. The maximum number is 20 characters.

■ Switch Type

The 2-notch action is as follows.

- When the knob is at Ch1 (left), pressing the right button switches the selector knob to Ch2 (right). During this action, the device for Ch1 is set to 0 and Ch2 is set to 1.
- When the knob is at Ch2 (right), pressing the left button switches the selector knob to Ch1 (left). During this action, the device for Ch1 is set to 1 and Ch2 is set to 0.

The 3-notch action is as follows.

- The knob behaves as follows for **3-Notch No-return**, **3-Notch R-return**, and **3-Notch L-return** button:
 - Press R-button: knob switches from Ch1 (left) -> Ch2 (middle) -> Ch3 (right), in that order.
 - Press L-button: knob switches from Ch3 (right) -> Ch2 (middle) -> Ch1 (left), in that order.
- Switching the knob writes 1 to the device for the new knob position, and 0 to the devices for the other two channels.

Whether the knob returns and the direction it returns depends on the switch type.

Select the switch type from the following.

2-Notch No-return: The knob does not return when the operator's finger is released.

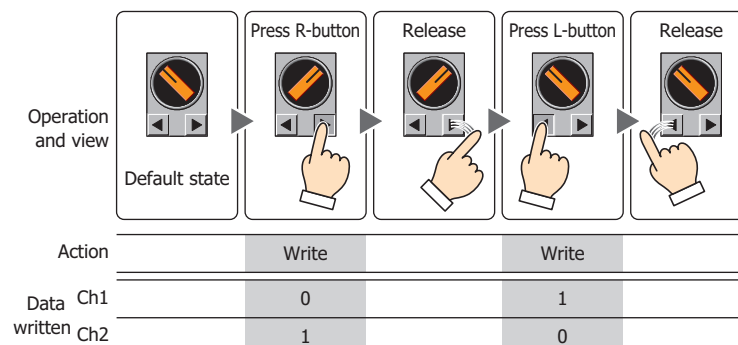

2-Notch R-return: After the knob switches from Ch1 to Ch2, it returns to Ch1 when the R-button is released.

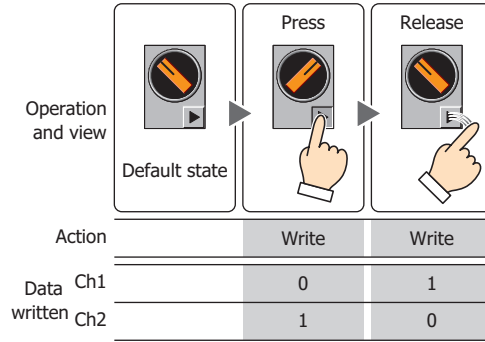

2-Notch L-return: After the knob switches from Ch2 to Ch1, it returns to Ch2 when the L-button is released.

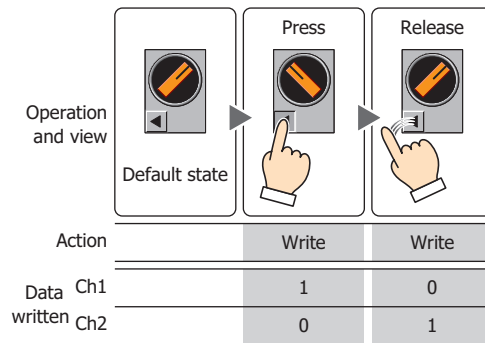

3-Notch No-return: The knob does not return when the operator's finger is released.

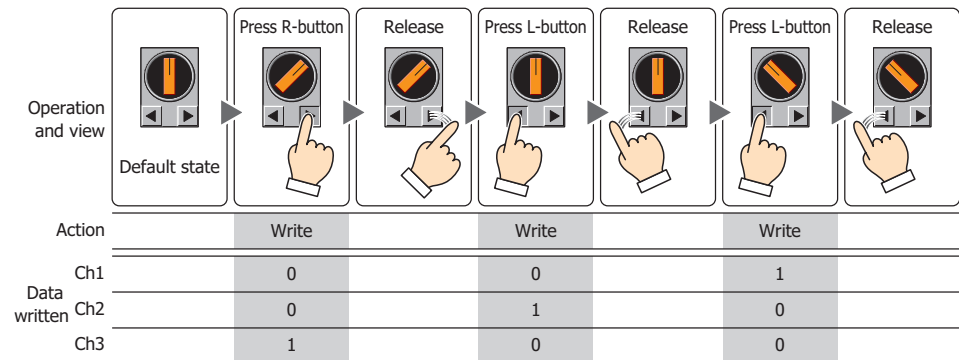

3-Notch R-return:
 • If the knob is switched to Ch3, it returns to Ch2 when the button is released.
 • If the knob is switched to Ch1, or from Ch1 to Ch2, it stays where it is even if the button is released.

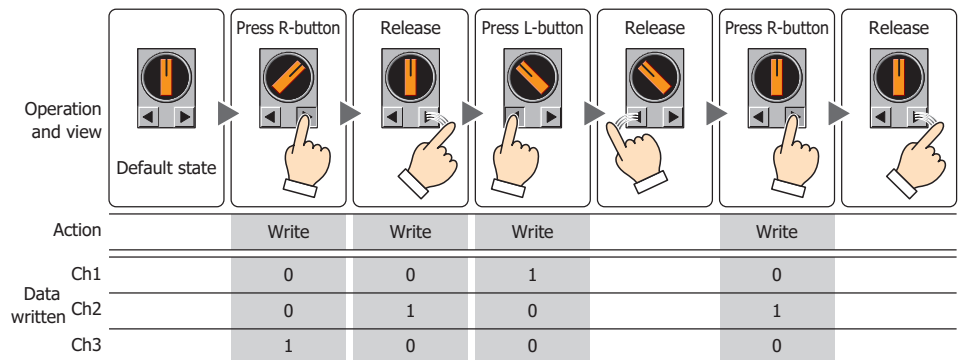

- 3-Notch L-return:
- If the knob is switched to Ch1, it returns to Ch2 when the button is released.
 - If the knob is switched to Ch2, or from Ch3 to Ch2, it stays where it is even if the button is released.

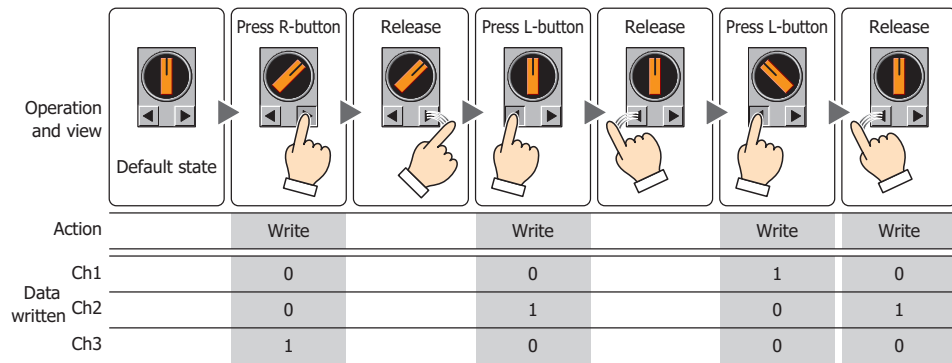

3-Notch Both-return: If the knob is switched to Ch1 or Ch3, it returns to Ch2 when the button is released.

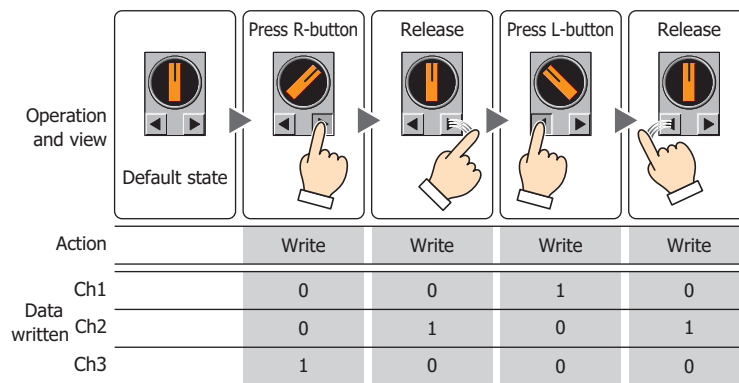

■ **Notch**

Register and edit the settings for each notch to each channel.

Use Text Manager: Select this check box to use the text registered in Text Manager as the Registration Text for each channel.

(List of Notch settings): This list shows the notch settings for each channel.

- No.: Shows the channel to be output. The number of notches selected in the **Switch Type** determines the number of channels. Double clicking the cell displays the Notch Settings dialog box where you can edit the notch settings. For details, refer to "Notch Settings dialog box" on page 7-100.
- Device: Shows the destination bit device or bit in the destination word device. Double clicking the cell displays the Device Address Settings dialog box where you can edit the device address. For the device address configuration procedure, refer to Chapter 2 "5.1 Device Address Settings" on page 2-61.
- Text: Shows the Registration Text for the channel. Double clicking the cell displays the Unicode Input dialog box where you can edit the Registration Text. If you select the **Use Text Manager** check box, the text ID is shown. Double clicking the cell displays Text Manager where you can edit the text.
- Color: Shows the color of the Registration Text for the channel. Double clicking the cell displays Color Palette. Select a color from the Color Palette.
- Set: Registers or changes the notch settings. Selecting a number that has already been registered changes the existing notch settings. Clicking **Set** displays the Notch Settings dialog box where you can configure the notch. For details, refer to "Notch Settings dialog box" on page 7-100. Notches are always registered from Ch1.

Insert:	Inserts a notch setting entry above the currently selected position. Select the channel number from the list where you want to insert the notch setting, and then click Insert . This displays the Notch Settings dialog box where you can configure the notch. The notch settings at the point of insertion shift down one line. Notch settings cannot be inserted if all channel numbers have a notch setting.
Remove:	Deletes the registered notch setting from the list. Select the channel number in the list, and then click Remove .
Default Position:	Selects the default position of the knob when the Touch starts operation and the Selector Switch is first displayed on the screen.
Ch1:	Makes Ch1 the default knob position. Writes 1 to the device configured for Ch1, writes 0 to the devices configured for the other channels.
Ch2:	Makes Ch2 the default knob position. Writes 1 to the device configured for Ch2, writes 0 to the devices configured for the other channels.
Ch3:	Makes Ch3 the default knob position. Writes 1 to the device configured for Ch3, writes 0 to the devices configured for the other channels.
Read from Destination Device:	The position of the knob is determined by the value of device.



The default knob position is fixed for these two switch types because of the return functionality.

2- Notch R-return: Ch1

2-Notch L-return, 3-Notch Both-return: Ch2



- If **Default Position** is **Ch1**, **Ch2**, or **Ch3**, the position of the knob does not change even if the value in the device configured for the channel changes, unless the change is caused by the buttons on the Selector Switch. If **Default Position** is **Read from Destination Device**, the position of the knob changes according to the value of device configured for the channel.
- When a Selector Switch is redisplayed immediately after switching the screen or when a hidden Selector Switch is redisplayed, values are not written to the destination devices for the channels.
- If the value in the device used to determine the default knob position contains an illegal value, the knob will be shown as follows:
 - 2- Notch No-return: Ch1
 - 3-Notch: Ch2

Notch Settings dialog box

This dialog configures a notch for a channel. If the channel has already been set with a notch, the setting is overwritten.

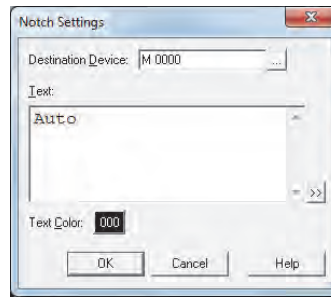

■ Destination Device

Specify the destination bit device or bit in the destination word device.

Click to display the Device Address Settings dialog box. For the device address configuration procedure, refer to Chapter 2 "5.1 Device Address Settings" on page 2-61.

■ Text

Enter the Registration Text for the channel.

The characters that can be entered depends on the font selected for **Font** on the **Format** tab. For details, refer to Chapter 2 "1.2 Available Text" on page 2-5.



To enter Unicode characters, click to display the Unicode Input dialog box. Enter the characters in the Unicode Input dialog box, and then click **OK**.

■ Text ID

To use the text registered in Text Manager as the Registration Text for the channel, specify the ID number from 1 to 32,000.

Click to display Text Manager.

This setting is only enabled if you select the **Use Text Manager** check box.

■ Text Color

Select the Registration Text color for the channel (color: 256 colors, monochrome: 8 shades).

Displays the Color Palette when the **Color** button is clicked. Select a color from the Color Palette.

● View Tab

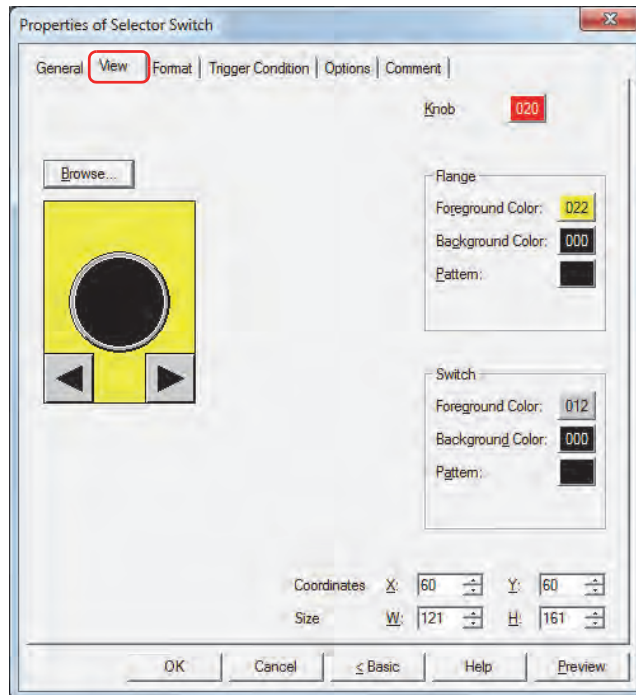

■ Browse

Select the type of graphic to be used to represent the part from the list of graphics. Click this button to display the View Browser.

■ Knob

Selects the knob color of the Selector Switch (color: 256 colors, monochrome: 8 shades). Click the **Color** button to display the Color Palette. Select a color from the Color Palette.



■ Flange

Foreground Color, Background Color: Selects the foreground and background colors of the flange (color: 256 colors, monochrome: 8 shades). Click the **Color** button to display the Color Palette. Select a color from the Color Palette.

Pattern: Selects a pattern for the flange. Click the **Pattern** button to display the Pattern Palette. Select a pattern from the Pattern Palette.



■ Switch

Foreground Color, Background Color: Selects the foreground and background colors of the buttons (color: 256 colors, monochrome: 8 shades). Click the **Color** button to display the Color Palette. Select a color from the Color Palette.

Pattern: Selects a pattern for the button. Click the **Pattern** button to display the Pattern Palette. Select a pattern from the Pattern Palette.



■ Coordinates

X, Y: Sets the display position of parts using coordinates.

The X and Y coordinates of parts are defined relative to an origin at the top-left corner of the screen.

X: 0 to (Base Screen horizontal size - 1)

Y: 0 to (Base Screen vertical size - 1)

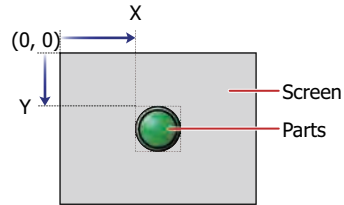

■ Size

W, H: Sets width and height to define the size of parts.

W: 20 to (Base Screen horizontal size)

H: 20 to (Base Screen vertical size)

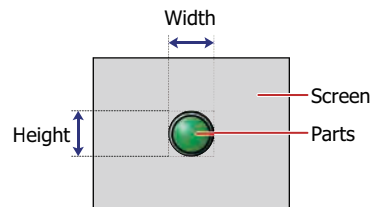

● Format Tab

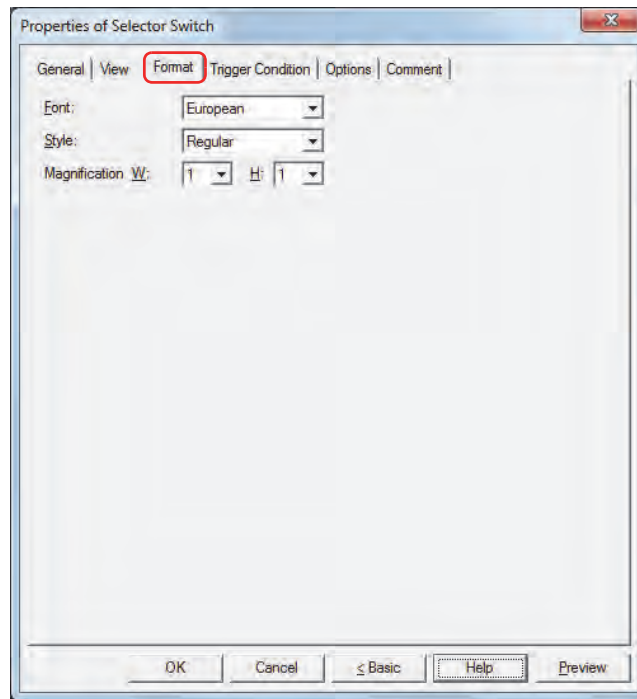

■ Font

Selects the font used for displaying text from the following.

Japanese, European, Chinese, Taiwanese, Korean, Central European, Baltic, Cyrillic

The characters that can be displayed depend on the font. For details, refer to Chapter 2 "1.2 Available Text" on page 2-5.

■ Style

Selects **Regular** or **Bold** for text style.

■ Magnification

W, H: Selects the magnification (0.5, 1 to 8) for text display.

● **Trigger Condition Tab**

The **Trigger Condition** tab is displayed in Advanced mode.

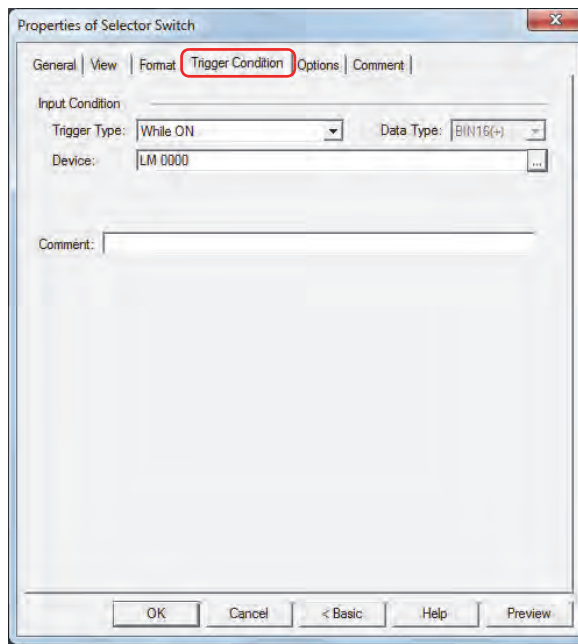

■ **Input Condition**

The Selector Switch is enabled and operational while the condition is satisfied. The Selector Switch is disabled and not operational while the condition is not satisfied.

Example: When **Trigger Type** is **While ON** and **Device** is LM0

While LM0 is 0, the condition is not satisfied and the Selector Switch is not operational.

While LM0 is 1, the condition is satisfied and the Selector Switch is operational.

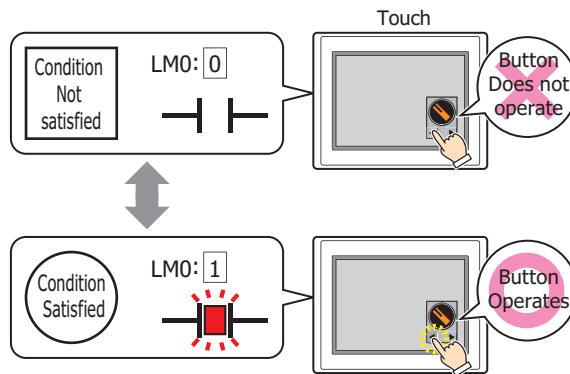

Trigger Type: Selects the condition to enable the Selector Switch from the following.

Always Enabled: The Selector Switch is always enabled.

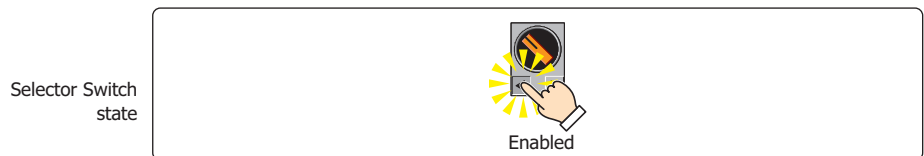

While ON: Enables the Selector Switch when the value of device is 1.

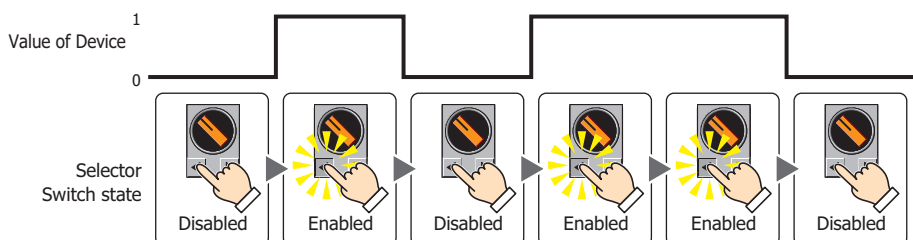

While OFF: Enables the Selector Switch when the value of device is 0.

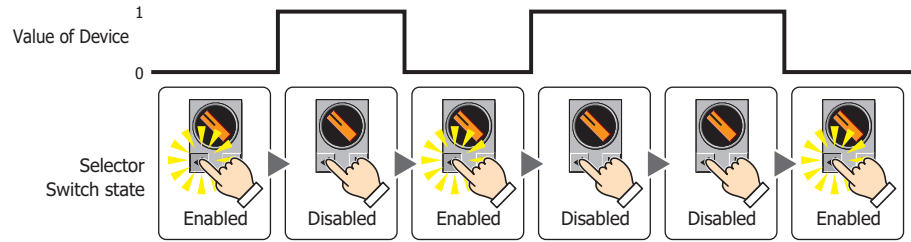

While satisfying the condition:

Enables the Selector Switch when the condition is satisfied.

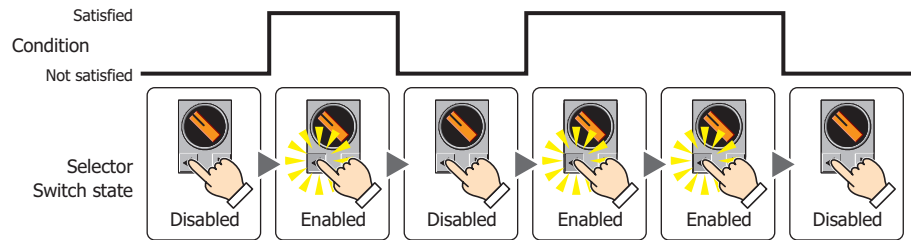

- Data Type:** Selects the type of data handled by the conditional expression for the input condition. This option can only be configured if **While satisfying the condition** is selected for **Trigger Type**. For details, refer to Chapter 2 “1.1 Available Data” on page 2-1.
- Device:** Specifies the bit device or bit of the word device to serve as the input condition. This option can only be configured when **While ON** or **While OFF** is selected for **Trigger Type**. Click to display the Device Address Settings dialog box. For the device address configuration procedure, refer to Chapter 2 “5.1 Device Address Settings” on page 2-61.
- Condition:** Specifies the conditional expression for the input condition. This option can only be configured when **While satisfying the condition** is selected for **Trigger Type**. Click to display the Trigger Condition Settings dialog box. For the conditional expression configuration procedure, refer to Chapter 2 “5.2 Setting Conditional Expressions” on page 2-63.
- Comment:** Enter a comment for the input condition. The maximum number is 80 characters.

● Options Tab

The **Options** tab is displayed in Advanced mode.

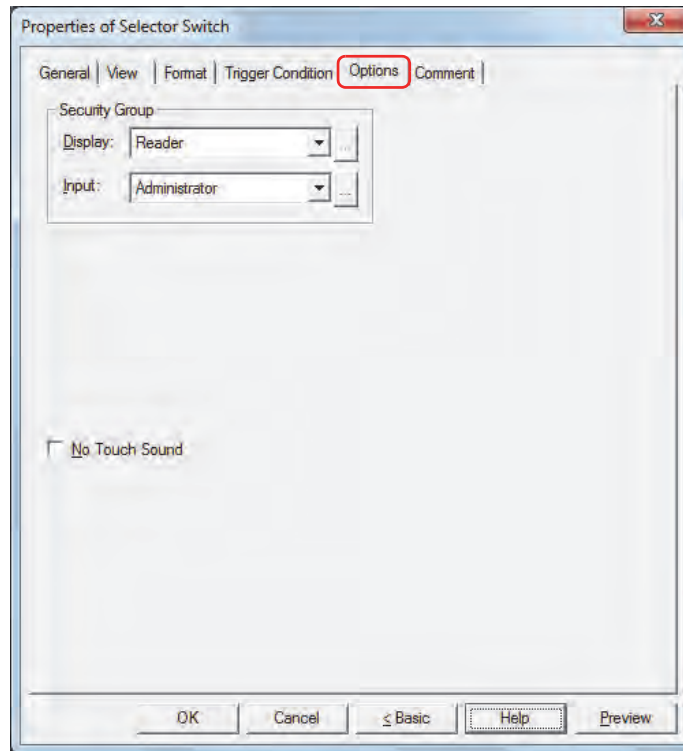

■ Security Group

Security groups are a security function for restricting the display and operation of parts.

Display: Selects the security group for which display of parts is restricted. (Default: None)

None: No security function is used.

Administrator, Operator, Reader: Three security groups are set up by default.

Click  to display the Security Group Settings dialog box. If you create a security group on the Security Group Settings dialog box, you can select that created group. For details, refer to Chapter 21 "2.2 Adding and Editing Security Groups" on page 21-15.

Input: Selects the security group for which operation of parts is restricted. (Default: None)

None: No security function is used.



Administrator, Operator, Reader: Three security groups are set up by default.

Click  to display the Security Group Settings dialog box. If you create a security group on the Security Group Settings dialog box, you can select that created group. For details, refer to Chapter 21 "2.2 Adding and Editing Security Groups" on page 21-15.



For details about security functions, refer to Chapter 21 "User Accounts and the Security Function" on page 21-1.

Example: If the user and security group for a part are set as follows:

User Name	 User1	 User2	 User3
Security Group	None	Group A	Group A, Group B

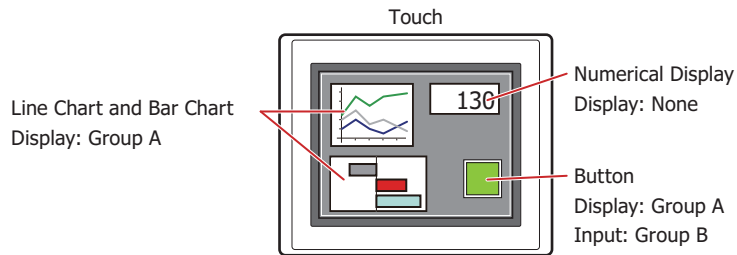

For User1, who is not included in the specified security group, Group A parts are not displayed. If the Password Screen is now opened and User2 logs in, Group A parts are displayed.

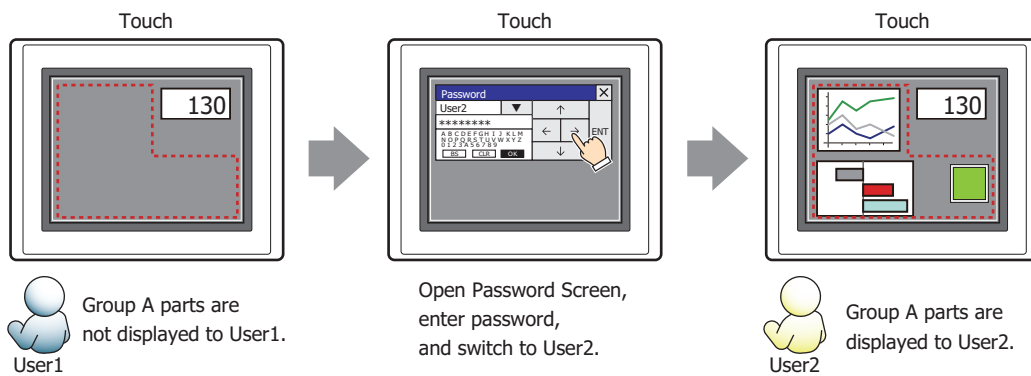

Since the display security group is Group A, User2 can view the buttons. But since the input security group is Group B, User2 cannot operate the buttons.

Suppose that the Password Screen is now opened and User3 logs in to the system. Group A buttons can be displayed, and Group B buttons can be operated.

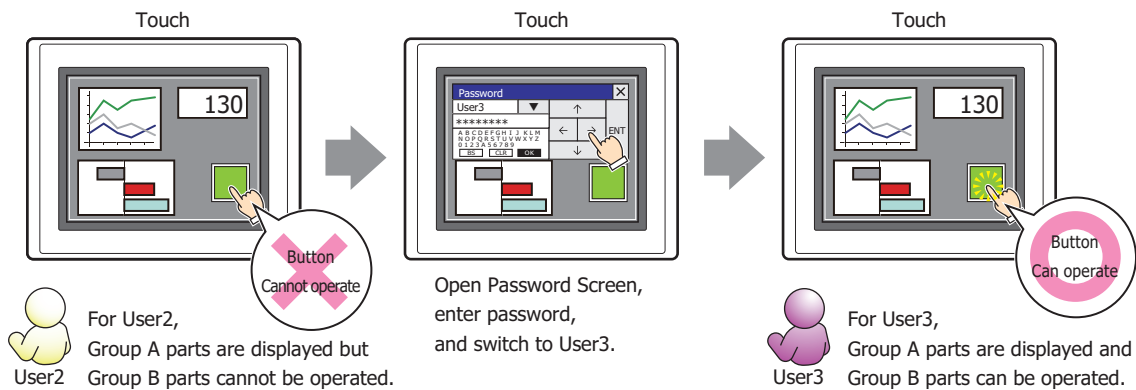

No Touch Sound

This function is to disable touch sounds only for specified parts when the Touch makes touch sounds. Select this check box to display disable touch sounds for this part.



To enable touch sounds on the Touch, select the Enable Touch Sound check box under the **System** tab of the Project Settings dialog box.

● Comment Tab

The **Comment** tab is used to specify the parts arranged on the editing screen, and the popup text displayed when the mouse pointer is placed close to **No.**, **Name**, or **Type** in the object list.



When there are multiple parts of the same shape on the screen, this feature makes it possible to distinguish between the parts without displaying the Properties dialog box for each part, by just mousing over the part.

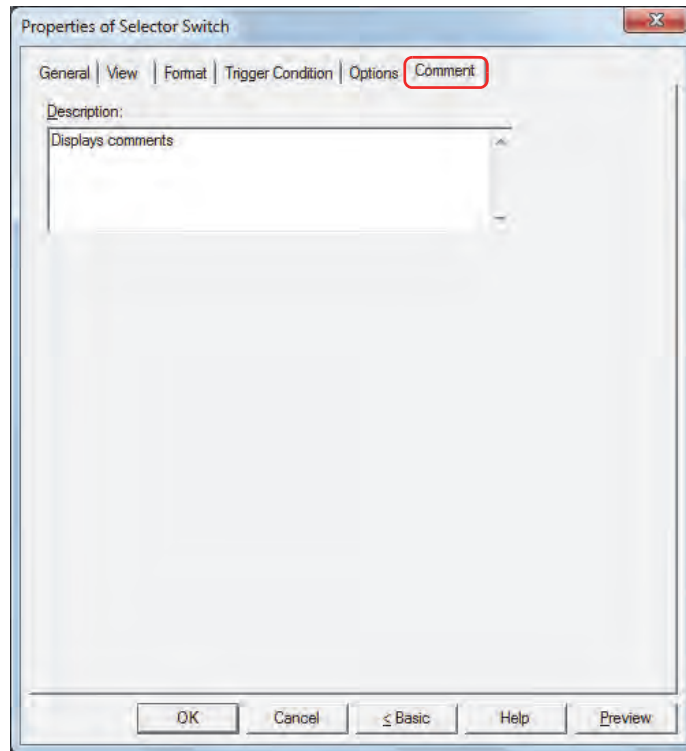

■ Description

Enter a comment about parts. The maximum number is 80 characters.

Example: When mousing over the Selector Switch on the editing screen

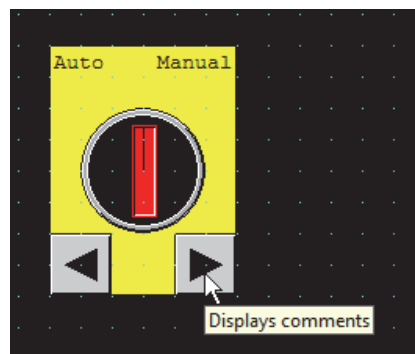

8 Potentiometer

8.1 How the Potentiometer is Used

Writes a value to a word device by pressing a slider button.

- The slider display position increases and decreases while the button is depressed. The value of the slider at the displayed position is written to the device when the button is released.

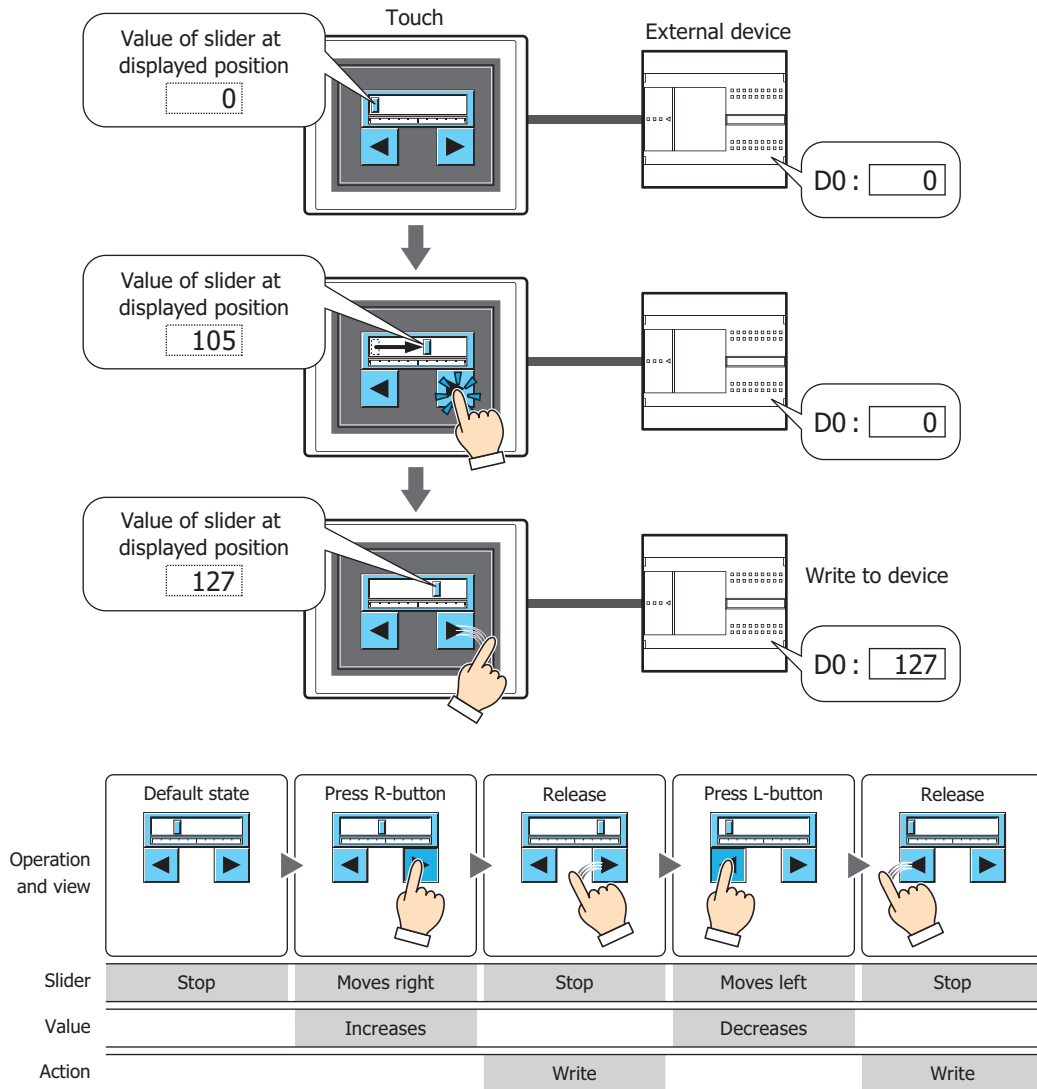

The slider indicates the value written to the device. When the value is increased or decreased, the slider display position also changes.

The slider moves between a user-defined minimum and maximum value.

The input value increases and decreases while the button is depressed. The value of the slider at the displayed position is written to the device when the button is released.



The slider display position does not change when the value of Destination Device changes unless it was changed by the Potentiometer buttons. However, immediately after the screen is switched and immediately after the part is displayed on the screen, the slider is displayed at the position specified by the value of Destination Device.

8.2 Potentiometer Configuration Procedure

This section describes the configuration procedure for Potentiometer parts.

- 1 On the **Home** tab, in the **Parts** group, click **Buttons**, and then click **Potentiometer**.

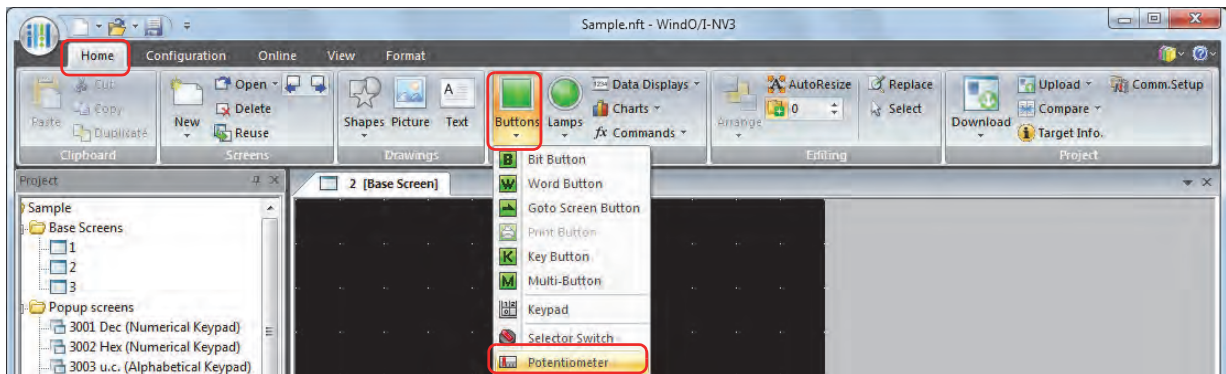

- 2 Click a point on the edit screen where you want to place the Potentiometer.
- 3 Double-click the dropped Potentiometer and a Properties dialog box will be displayed.
- 4 Change the settings on each tab as necessary.

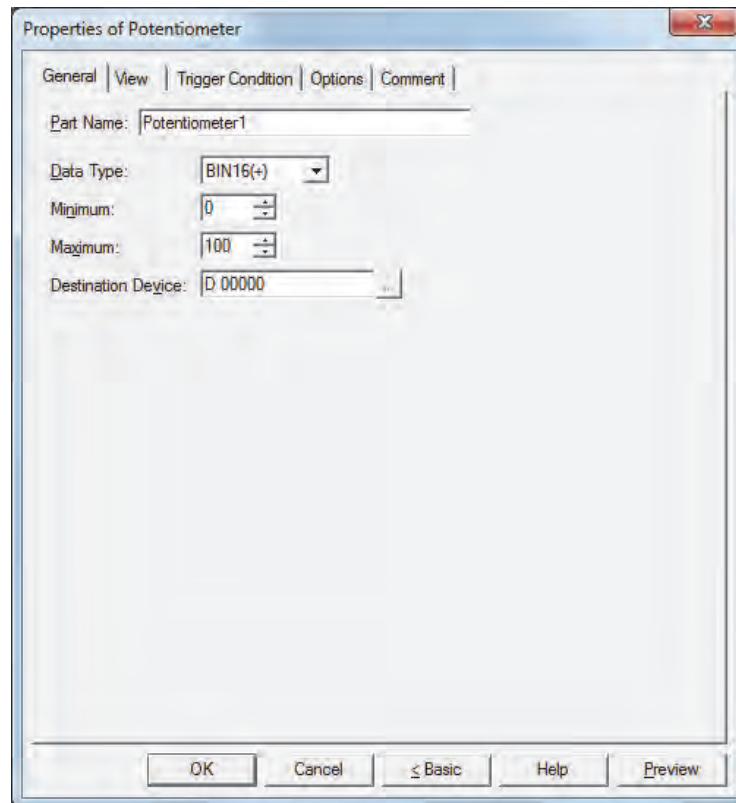

The **Trigger Condition** tab and **Options** tab only appear in Advanced mode. To switch to Advanced mode, click **Advanced**.

8.3 Properties of Potentiometer Dialog Box

This section describes items and buttons in the Properties dialog box.

● General Tab

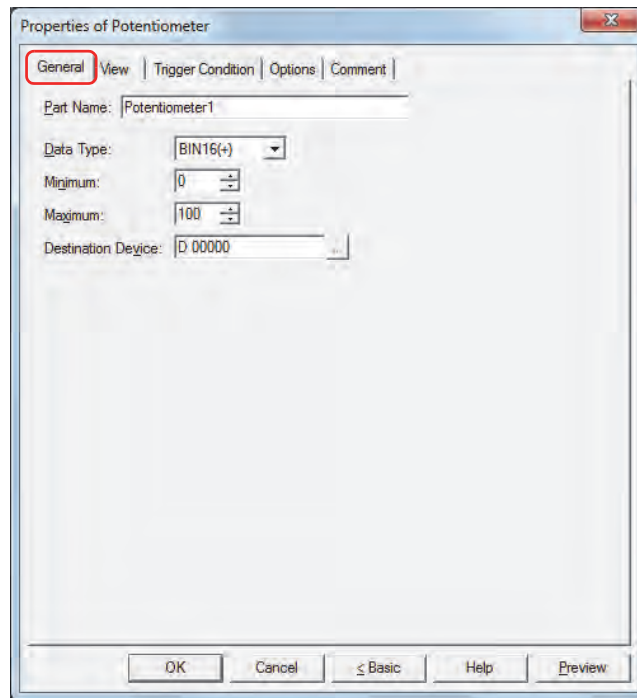

■ Part Name

Enter a name for the part. The maximum number is 20 characters.

■ Data Type

Select the data type handled by the Potentiometer.

For details, refer to Chapter 2 “1.1 Available Data” on page 2-1.

■ Minimum

Specify the minimum value that can be entered. The minimum value varies based on the data type.

■ Maximum

Specify the maximum value that can be entered. The maximum value varies based on the data type.

■ Destination Device

Specify the destination word device.

Click to display the Device Address Settings dialog box. For the device address configuration procedure, refer to Chapter 2 “5.1 Device Address Settings” on page 2-61.

● View Tab

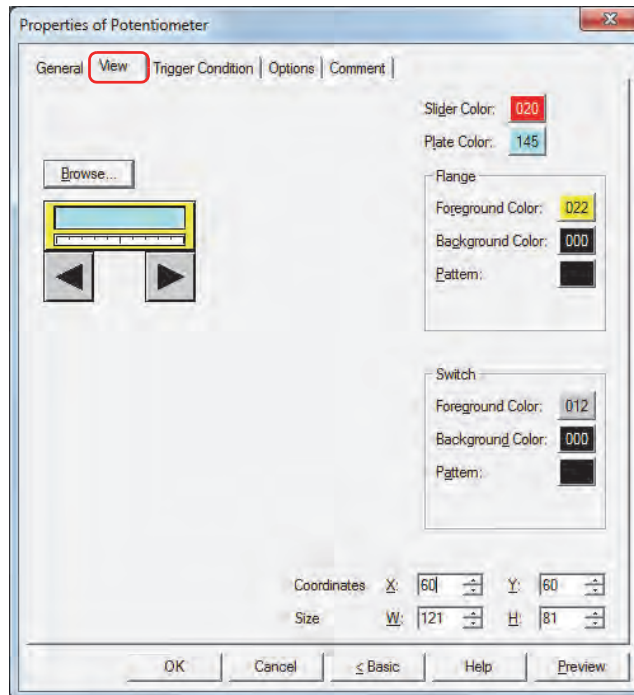

■ Browse

Select the type of graphic to be used to represent the part from the list of graphics. Click this button to display the View Browser.

■ Slider Color

Selects the slider color of the Potentiometer (color: 256 colors, monochrome: 8 shades). Click the **Color** button to display the Color Palette. Select a color from the Color Palette.

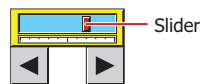

■ Plate Color

Selects the plate color (color: 256 colors, monochrome: 8 shades). Click the **Color** button to display the Color Palette. Select a color from the Color Palette.



■ Flange

Foreground Color, Background Color: Selects the foreground and background colors of the flange (color: 256 colors, monochrome: 8 shades). Click the **Color** button to display the Color Palette. Select a color from the Color Palette.

Pattern: Selects a pattern for the flange. Click the **Pattern** button to display the Pattern Palette. Select a pattern from the Pattern Palette.

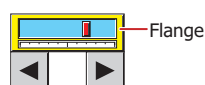

■ Switch

Foreground Color, Background Color: Selects the foreground and background colors of the buttons (color: 256 colors, monochrome: 8 shades).
Click the **Color** button to display the Color Palette. Select a color from the Color Palette.

Pattern: Selects a pattern for the button.
Click the **Pattern** button to display the Pattern Palette. Select a pattern from the Pattern Palette.



■ Coordinates

X, Y: Sets the display position of parts using coordinates.
The X and Y coordinates of parts are defined relative to an origin at the top-left corner of the screen.

X: 0 to (Base Screen horizontal size - 1)

Y: 0 to (Base Screen vertical size - 1)

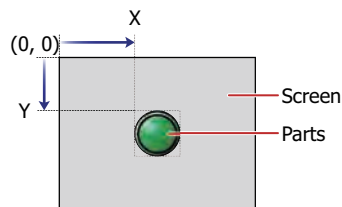

■ Size

W, H: Sets width and height to define the size of parts.

W: 20 to (Base Screen horizontal size)

H: 20 to (Base Screen vertical size)

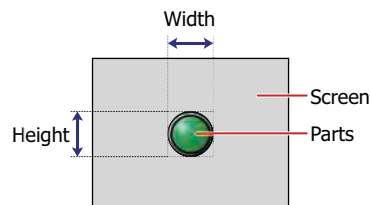

● **Trigger Condition Tab**

The **Trigger Condition** tab is displayed in Advanced mode.

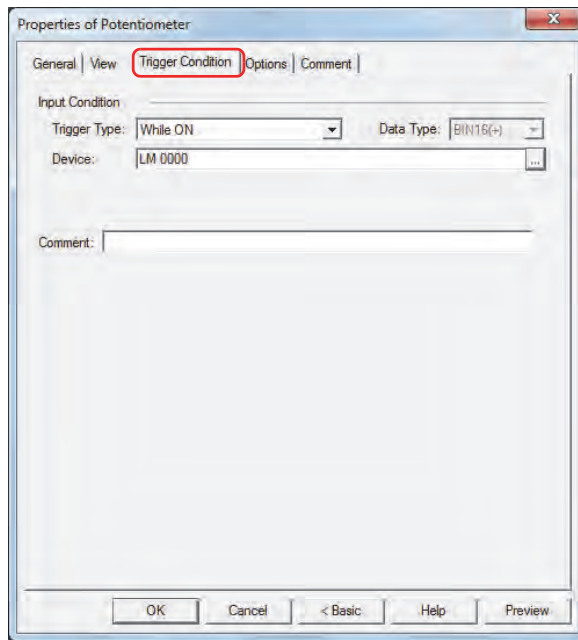

■ **Input Condition**

The Potentiometer is enabled and operational while the condition is satisfied. The Potentiometer is disabled and not operational while the condition is not satisfied.

Example: When **Trigger Type** is **While ON** and **Device** is LM0

While LM0 is 0, the condition is not satisfied and the Potentiometer is not operational.

While LM0 is 1, the condition is satisfied and the Potentiometer is operational.

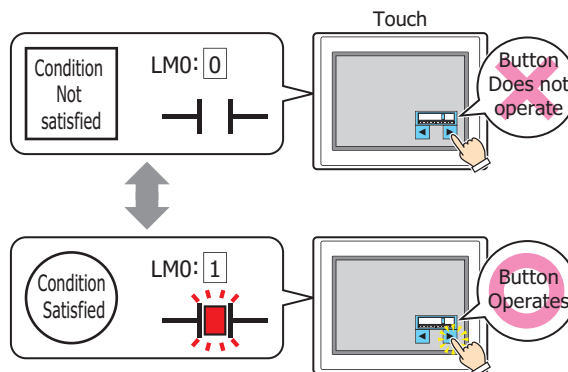

Trigger Type: Selects the condition to enable the Potentiometer from the following.

Always Enabled: The Potentiometer is always enabled.

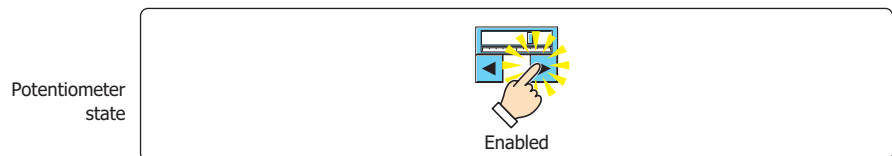

While ON: Enables the Potentiometer when the value of device is 1.

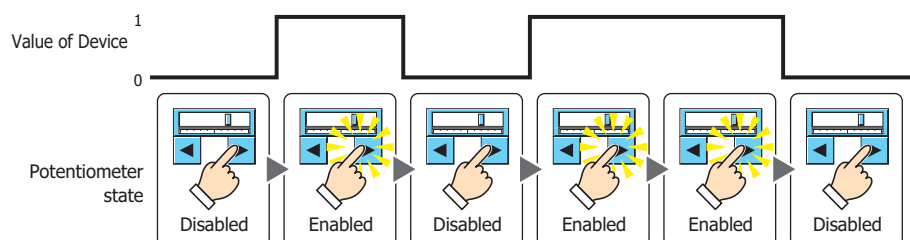

While OFF: Enables the Potentiometer when the value of device is 0.

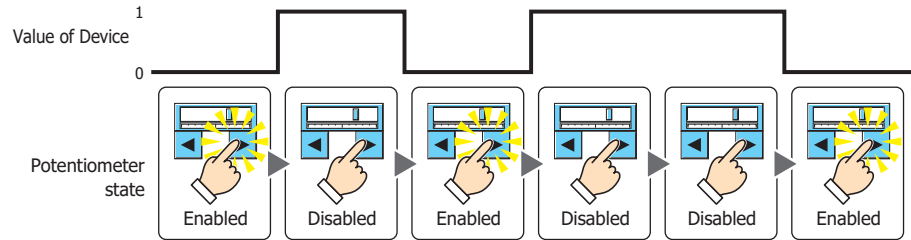

While satisfying the condition:

Enables the Potentiometer when the condition is satisfied.

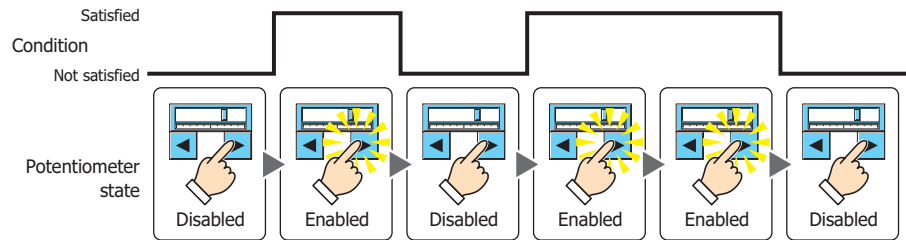

- Data Type:** Selects the type of data handled by the conditional expression for the input condition. This option can only be configured if **While satisfying the condition** is selected for **Trigger Type**. For details, refer to Chapter 2 “1.1 Available Data” on page 2-1.
- Device:** Specifies the bit device or bit of the word device to serve as the input condition. This option can only be configured when **While ON** or **While OFF** is selected for **Trigger Type**. Click to display the Device Address Settings dialog box. For the device address configuration procedure, refer to Chapter 2 “5.1 Device Address Settings” on page 2-61.
- Condition:** Specifies the conditional expression for the input condition. This option can only be configured when **While satisfying the condition** is selected for **Trigger Type**. Click to display the Trigger Condition Settings dialog box. For the conditional expression configuration procedure, refer to Chapter 2 “5.2 Setting Conditional Expressions” on page 2-63.
- Comment:** Enter a comment for the input condition. The maximum number is 80 characters.

● Options Tab

The **Options** tab is displayed in Advanced mode.

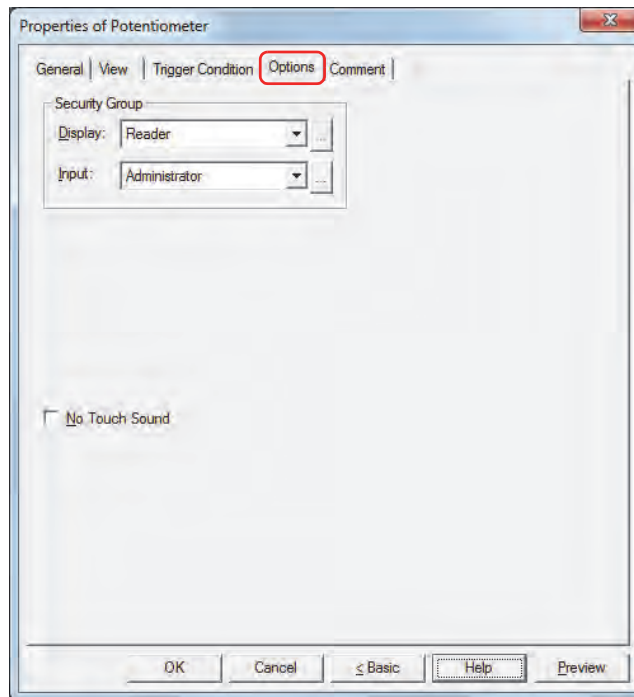

■ Security Group

Security groups are a security function for restricting the display and operation of parts.

Display: Selects the security group for which display of parts is restricted. (Default: None)

None: No security function is used.

Administrator, Operator, Reader: Three security groups are set up by default.

Click  to display the Security Group Settings dialog box. If you create a security group on the Security Group Settings dialog box, you can select that created group. For details, refer to Chapter 21 “2.2 Adding and Editing Security Groups” on page 21-15.

Input: Selects the security group for which operation of parts is restricted. (Default: None)

None: No security function is used.



Administrator, Operator, Reader: Three security groups are set up by default.

Click  to display the Security Group Settings dialog box. If you create a security group on the Security Group Settings dialog box, you can select that created group. For details, refer to Chapter 21 “2.2 Adding and Editing Security Groups” on page 21-15.



For details about security functions, refer to Chapter 21 “User Accounts and the Security Function” on page 21-1.

Example: If the user and security group for a part are set as follows:

User Name	 User1	 User2	 User3
Security Group	None	Group A	Group A, Group B

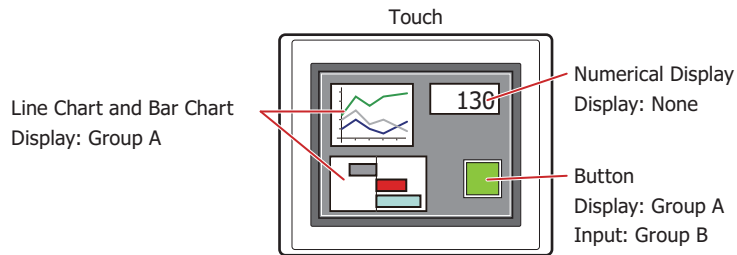

For User1, who is not included in the specified security group, Group A parts are not displayed. If the Password Screen is now opened and User2 logs in, Group A parts are displayed.

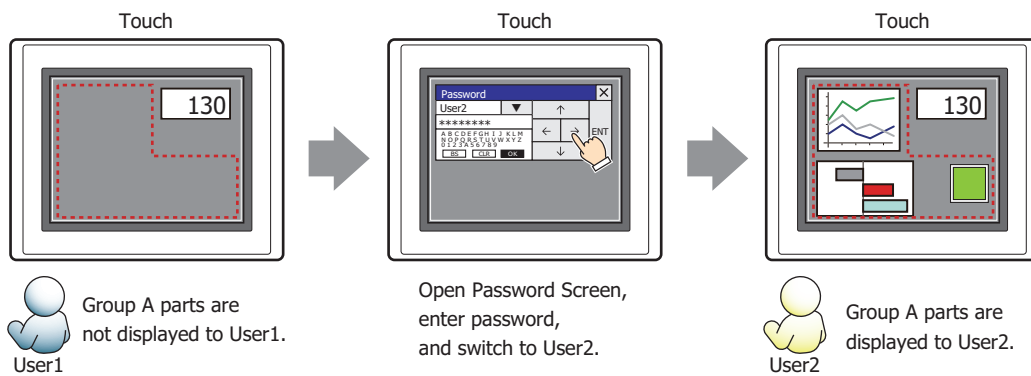

Since the display security group is Group A, User2 can view the buttons. But since the input security group is Group B, User2 cannot operate the buttons.

Suppose that the Password Screen is now opened and User3 logs in to the system. Group A buttons can be displayed, and Group B buttons can be operated.

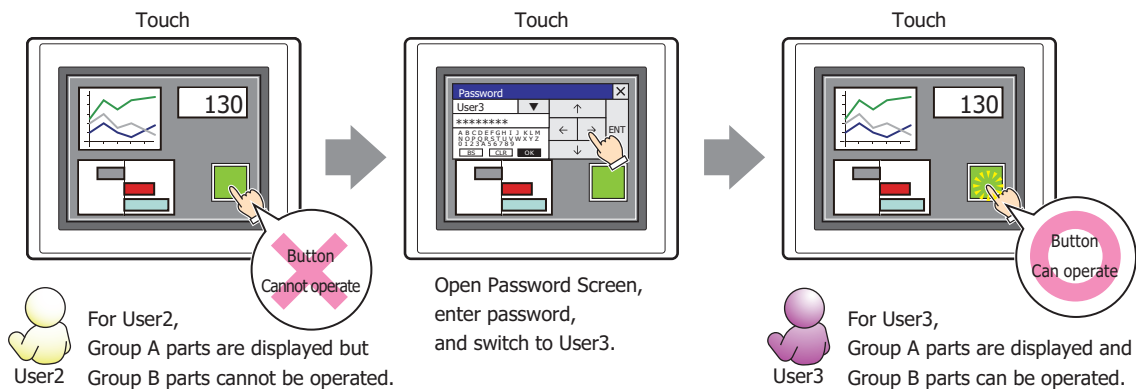

■ **No Touch Sound**

This function is to disable touch sounds only for specified parts when the Touch makes touch sounds. Select this check box to display disable touch sounds for this part.



To enable touch sounds on the Touch, select the **Enable Touch Sound** check box under the **System** tab of the **Project Settings** dialog box.

● Comment Tab

The **Comment** tab is used to specify the parts arranged on the editing screen, and the popup text displayed when the mouse pointer is placed close to **No.**, **Name**, or **Type** in the object list.



When there are multiple parts of the same shape on the screen, this features makes it possible to distinguish between the parts without displaying the Properties dialog box for each part, by just mousing over the part.

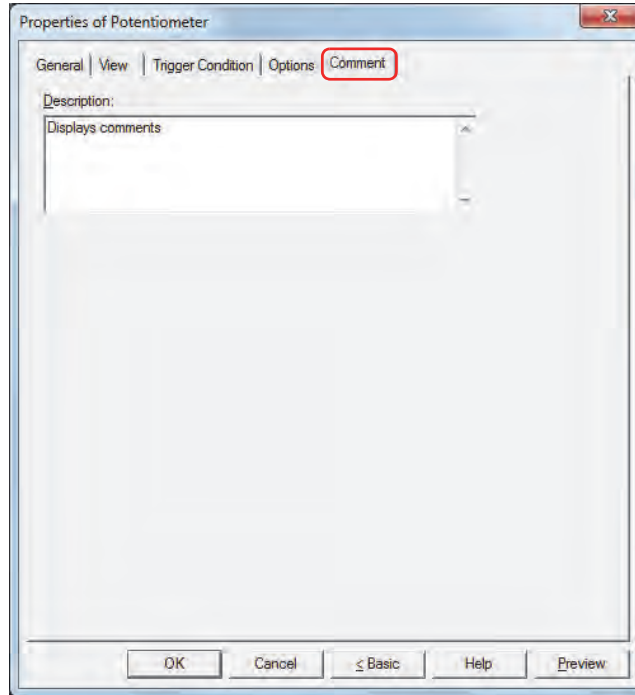

■ Description

Enter a comment about parts. The maximum number is 80 characters.

Example: When mousing over the Potentiometer on the editing screen

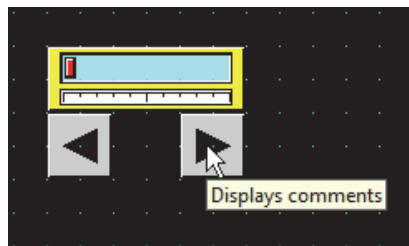

Chapter 8 Lamps

This chapter describes the setup for the lamp parts and related Touch operations.

1 Pilot Lamps

1.1 How the Pilot Lamp is Used

Pilot Lamp parts display drawing objects. The value of a bit device is used to switch the drawing object displayed.

- Switch and display pictures by the values of devices

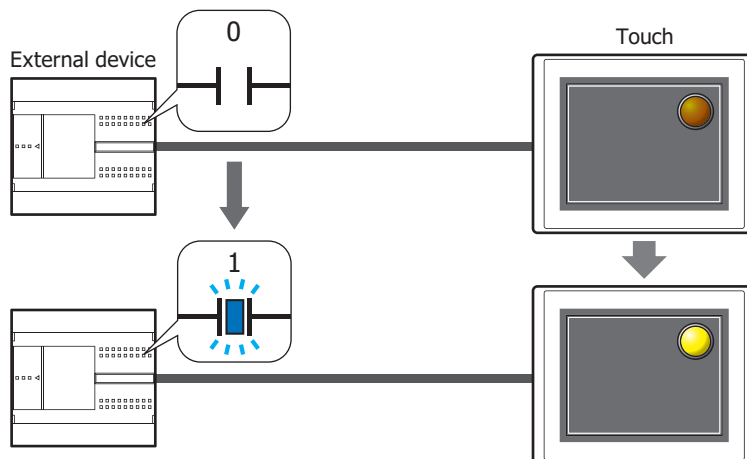

1.2 Pilot Lamp Configuration Procedure

This section describes the configuration procedure for Pilot Lamps.

- 1 On the **Home** tab, in the **Parts** group, click **Lamps**, and then click **Pilot Lamp**.

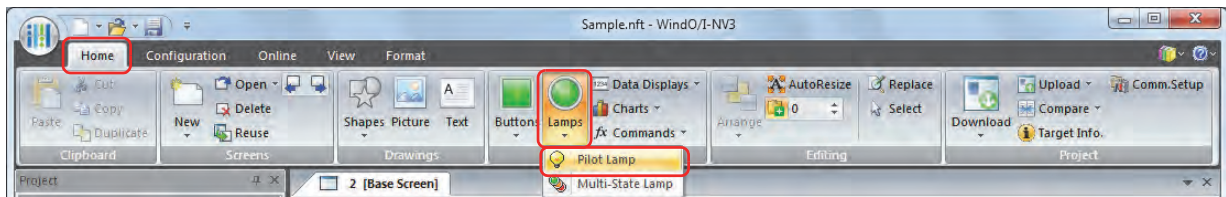

- 2 Click a point on the Edit screen where you want to place the Pilot Lamp.
- 3 Double-click the dropped Pilot Lamp and a Properties dialog box will be displayed.
- 4 Change the settings on each tab as necessary.

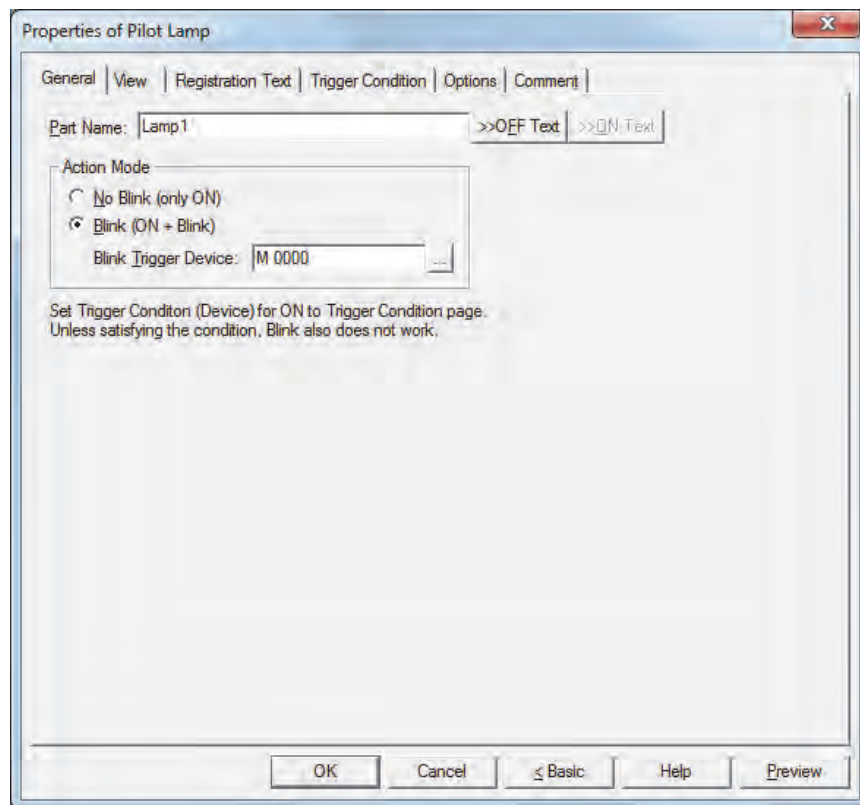

The **Options** tab only appears in Advanced mode.
To switch to Advanced mode, click **Advanced**.

1.3 Properties of Pilot Lamp Dialog Box

This section describes items and buttons on the properties dialog box.

● General Tab

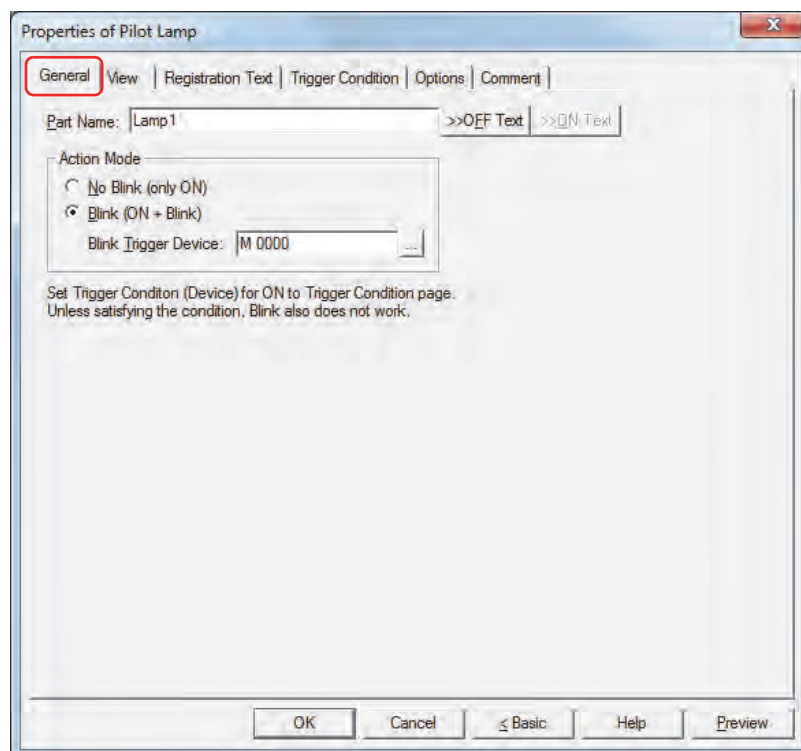

■ Part Name

Enter a name for the part. The maximum number is 20 characters.

■ >>OFF Text, >>ON Text

Applies the text entered in the **Part Name** field to the **Text** field under the **OFF** or **ON** fields on the **Registration Text** tab. This is used as the Registration Text when the lamp is OFF or ON.



To specify the Registration Text to use when the button is ON, select the **Set by State** check box on the **Registration Text** tab. If left unchecked, the same Registration Text assigned for the OFF state is displayed for the ON state as well.

■ Action Mode

Select the action when the part is ON.

No Blink (only ON): Displays the drawing object for the ON state when the trigger condition is satisfied.





Blink (ON + Blink): When the condition is satisfied and the value of the trigger device is 1, the object blinks (alternates between the drawing object for the ON and OFF states at fixed time interval). The blinking interval can be set with the **Blinking Cycle** setting on the **System** tab of the Project Settings dialog box.

Blink Trigger Device: Specify the bit device to cause the lamp to blink.

The lamp blinks when the value of device is 1. The action for **No Blink** applies when the value is 0.

Click  to display the Device Address Settings dialog box. For the device address configuration procedure, refer to Chapter 2 "5.1 Device Address Settings" on page 2-61.

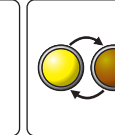
Example: When **Action Mode** is **Blink (ON + Blink)**, **Blink Trigger Device** is M0, and on the **Trigger Condition** tab, **Trigger Type** is **While ON**, **Device** is LMO

Trigger Condition: Device LMO value	0	1	1	0
Action Mode: Value in trigger device M0	0	0	1	1
Displayed drawing object				
Action	Displays OFF drawing object	Displays ON drawing object	Blinking	Displays OFF drawing object



The lamp will neither turn or blink if the trigger conditions are not met. Lamp trigger conditions are configured on the **Trigger Condition** tab.

● View Tab

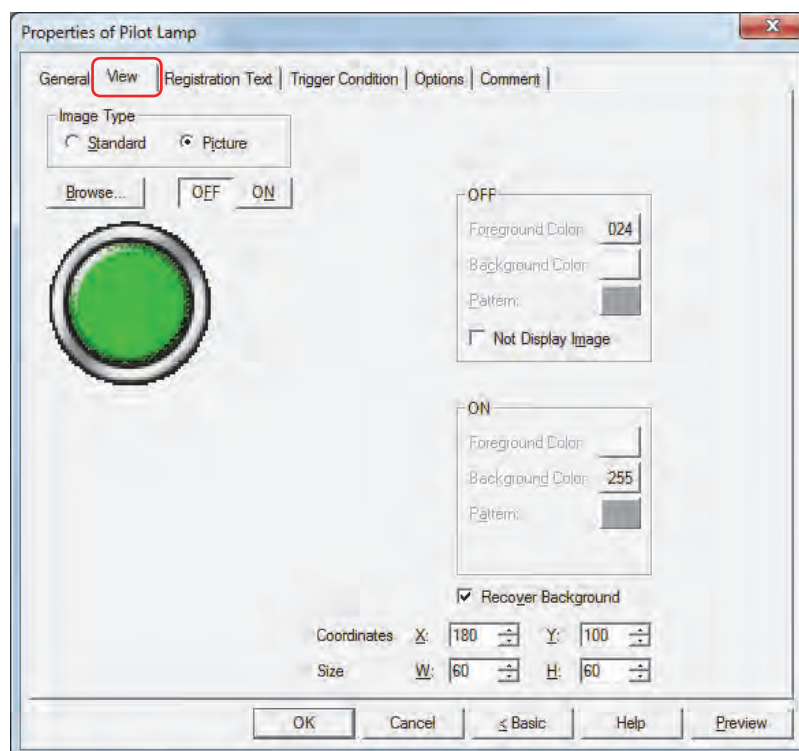

■ Image Type

Select the type of graphic to be used to represent the part.

Standard: Uses the default graphic for WindO/I-NV3.

Picture: Uses an image file saved using Picture Manager.

For details about image file restrictions, refer to Chapter 2 "1.4 Available Image Files" on page 2-18.

■ Browse

Select the type of graphic to be used to represent the part from the list of graphics. Click this button to display the View Browser or Picture Manager, depending on the setting for **Image Type**.

■ OFF button, ON button

Displays the graphic when ON or OFF. Clicking the **ON** button or **OFF** button switches the image displayed on the **View** tab.

■ OFF, ON

Selects the color and pattern of the standard graphic when ON and OFF.

Foreground Color, Background Color:

Selects the foreground and background colors of the standard graphic (color: 256 colors, monochrome: 8 shades).

Click the **Color** button to display the Color Palette. Select a color from the Color Palette.

Pattern: Selects a pattern for the standard graphic.

Click the **Pattern** button to display the Pattern Palette. Select a pattern from the Pattern Palette.

■ Not Display Image*1

Select this check box to display no drawing object in the OFF state.



If the **Not Display Image** check box is selected:

- The Recover Background function will always be enabled.
- Text set as registration text for the OFF state will be displayed.

*1 Advanced mode only

■ **Recover Background*1**

Select this check box to recover the background of the area where the picture had been displayed after the picture is switched. When this check box is cleared, the background is filled with the screen's **Background Color**.

When parts or drawings are arranged so they overlap the background of the Pilot Lamp (below), the background of parts and drawings is displayed as follows if the Pilot Lamp picture is hidden.

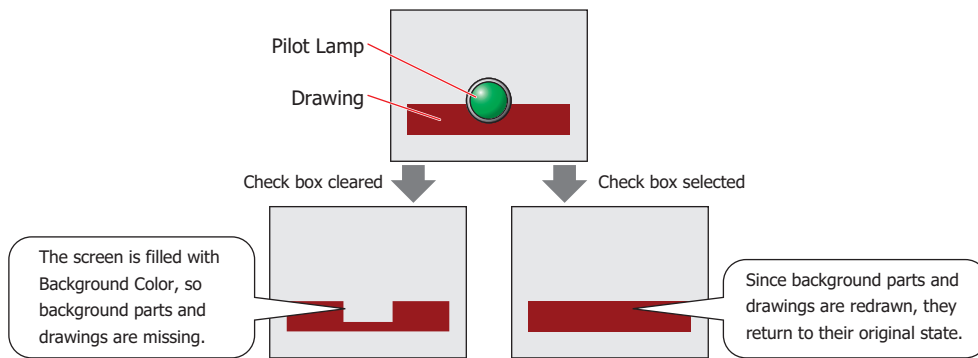

Can only be set when **Picture** is selected for **Image Type**.

However, when the background part is the Alarm List Display, Alarm Log Display, bar chart, line chart, or pie chart, the missing sections will remain.



If the **Recover Background** check box is selected, the number of parts that can be placed on a single screen decreases. If an error message appears when the Picture Display is displayed on the Touch, clear the **Recover Background** check box or reduce the number of parts.

■ **Coordinates**

X, Y: Sets the display position of parts using coordinates. The X and Y coordinates of parts is defined relative to an origin at the top-left corner of the screen.

X: 0 to (Base Screen horizontal size - 1)

Y: 0 to (Base Screen vertical size - 1)

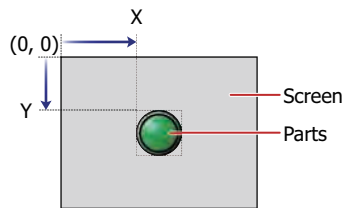

■ **Size**

W, H: Sets width and height to define the size of parts.

W: 5 to (Base Screen horizontal size)

H: 5 to (Base Screen vertical size)

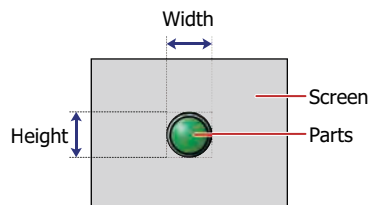

*1 Advanced mode only

● Registration Text Tab

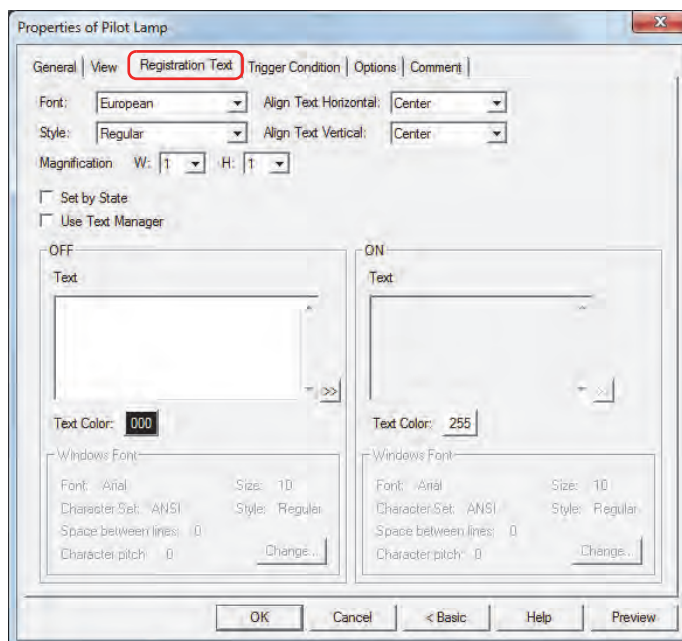

■ Font

Selects the font used for displaying text from the following.

Japanese, European, Chinese, Taiwanese, Korean, Central European, Baltic, Cyrillic, Windows

Can only be set when the **Use Text Manager** check box is cleared.

The characters that can be displayed depend on the font. For details, refer to Chapter 2 “1.2 Available Text” on page 2-5.

■ Style

Selects **Regular** or **Bold** for text style.

Can only be set when **Font** is set to **Japanese, European, Chinese, Taiwanese, Korean, Central European, Baltic** or **Cyrillic**.

■ Magnification

W, H: Selects the magnification (0.5, 1 to 8) for text display.

Can only be set when **Font** is set to **Japanese, European, Chinese, Taiwanese, Korean, Central European, Baltic** or **Cyrillic**.

■ Align Text Vertical

Selects text alignment in the vertical direction.

Top, Center, Bottom

For details, refer to Appendix “5 Text Alignment” on page A-5.

■ Align Text Horizontal

Selects text alignment in the horizontal direction.

Left, Center, Right, Center-Left

For details, refer to Appendix “5 Text Alignment” on page A-5.

■ Set by State

Select this check box if displaying different text when ON and OFF.

■ Use Text Manager

Select this check box if using the text registered in Text Manager for text display.

■ OFF, ON

Text: Inputs characters to be displayed on parts. The maximum number is 3,750 characters.
The characters that can be entered depend on the font selected using **Font**. For details, refer to Chapter 2 "1.2 Available Text" on page 2-5.



When entering Unicode characters click  to display the Unicode Input dialog box. Enter the characters using the Unicode Input dialog box then click **OK**.

Text ID: Specifies the Text Manager ID No. (1 to 32000) when using the text registered in Text Manager.
Click  to display Text Manager.
Can only be set when the **Use Text Manager** check box is selected.

Text Color: Selects the color of the text displayed on the part (color: 256 colors, monochrome: 8 shades).
Click the **Color** button to display the Color Palette. Select a color from the Color Palette.

Windows Font: Sets the font to be used as the Windows Font.
Select **Windows** using **Font** to display the current setting. To change the setting, click **Change** to display the Font dialog box.
Can only be set when the **Use Text Manager** check box is cleared.
For details, refer to Chapter 2 "Windows Font" on page 2-12.

● **Trigger Condition Tab**

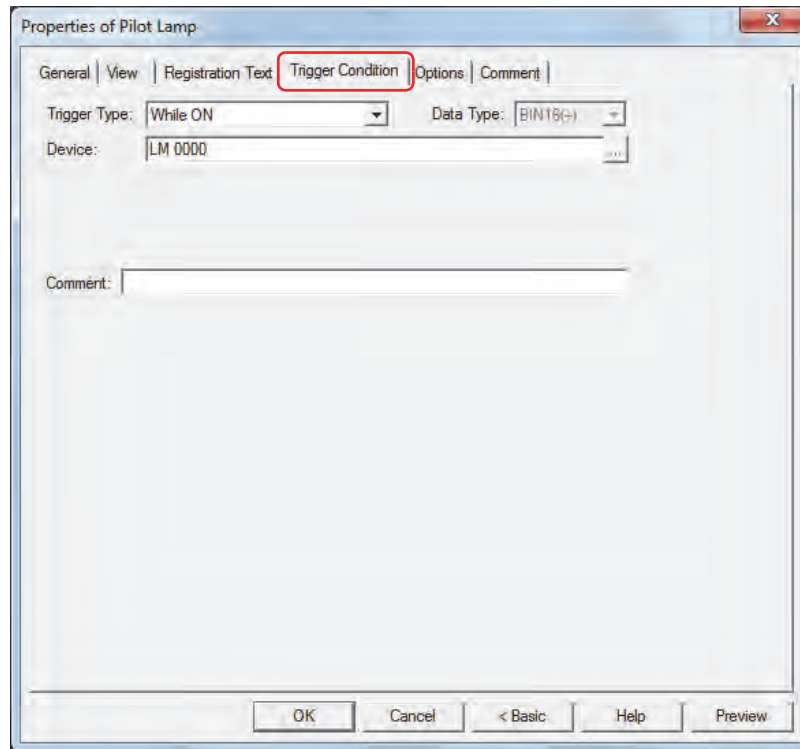

The Pilot Lamp is on while the condition is satisfied, and it is off while the condition is not satisfied. The Pilot Lamp displays the ON graphic when on and it displays the OFF graphic when off.

Example: When **Trigger Type** is **While ON** and **Device** is LM0

- When LM0 is 0, condition is not satisfied, so Lamp displays OFF graphic.
- When LM0 is 1, condition is satisfied, so Lamp displays ON graphic.

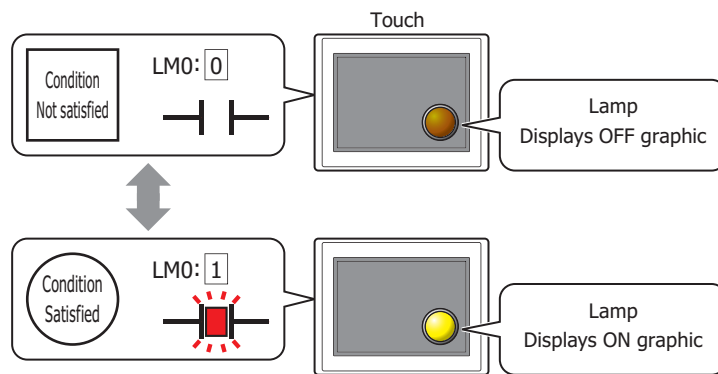

■ **Trigger Type**

Selects the condition to turn on the Pilot Lamp from the following.

While ON:

Turns on the Pilot Lamp when the value of device is 1.

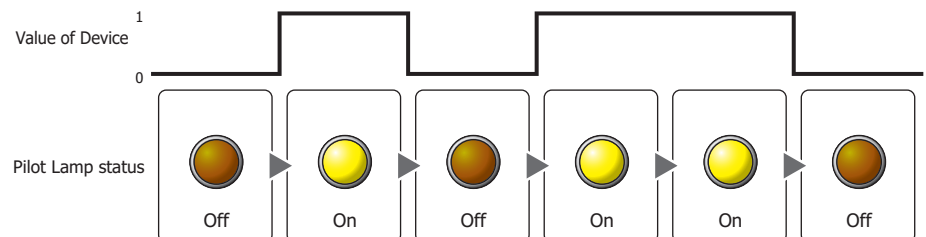

While OFF:

Turns on the Pilot Lamp when the value of device is 0.

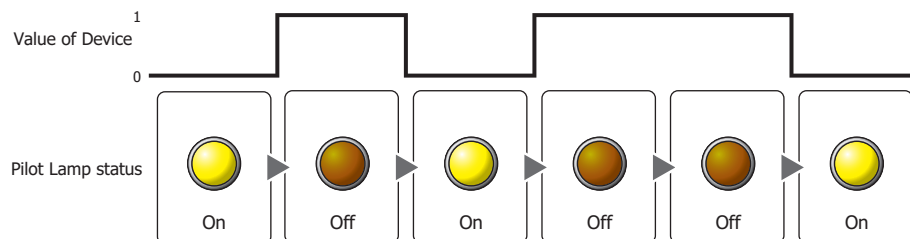

While satisfying the condition: Turns on the Pilot Lamp when the condition is satisfied.

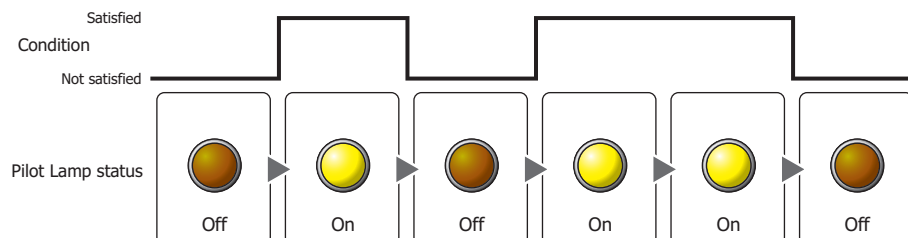

■ Data Type

Selects the type of data handled by the conditional expression for the on condition.

This option can only be configured if **While satisfying the condition** is selected for **Trigger Type**.

For details, refer to Chapter 2 "1.1 Available Data" on page 2-1.

■ Device

Specifies the bit device or bit of the word device to serve as the on condition.

This option can only be configured when **While ON** or **While OFF** is selected for **Trigger Type**.

Click to display the Device Address Settings dialog box. For the device address configuration procedure, refer to Chapter 2 "5.1 Device Address Settings" on page 2-61.

■ Condition

Specifies the conditional expression for the on condition.

This option can only be configured when **While satisfying the condition** is selected for **Trigger Type**.

Click to display the Trigger Condition Settings dialog box. For the conditional expression configuration procedure, refer to Chapter 2 "5.2 Setting Conditional Expressions" on page 2-63.

■ Comment

Enter a comment for the on condition. The maximum number is 80 characters.

● Options Tab

The **Options** tab is displayed in Advanced mode.

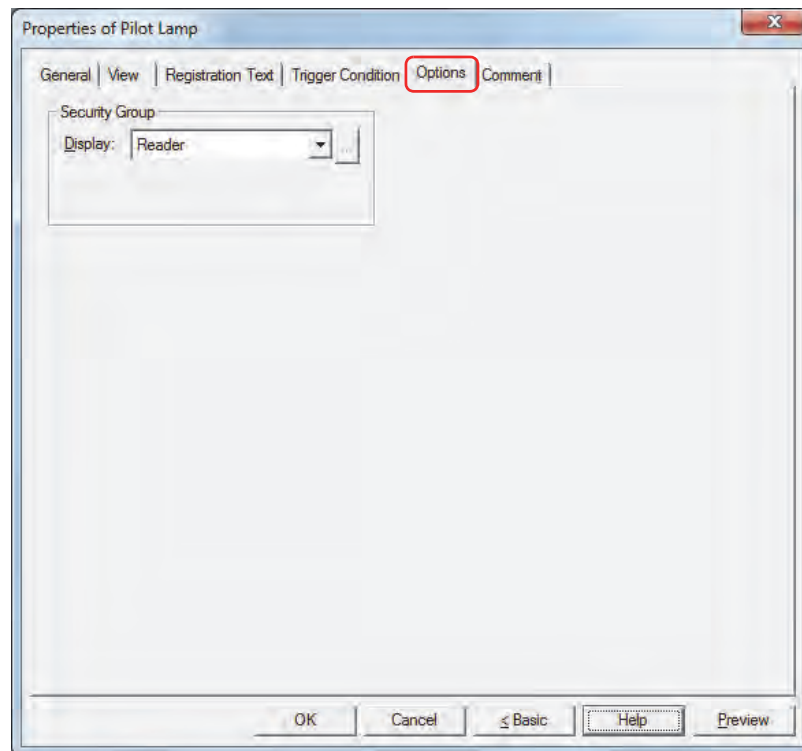

■ Security Group

Security groups are a security function for restricting the display and operation of parts.

Display: Selects the security group for which display of parts is restricted. (Default: None)

None: No security function is used.



Administrator, Operator, Reader: Three security groups are set up by default.

Click  to display the Security Group Settings dialog box. If you create a security group on the Security Group Settings dialog box, you can select that created group. For details, refer to Chapter 21 "2.2 Adding and Editing Security Groups" on page 21-15.



For details about security functions, refer to Chapter 21 "User Accounts and the Security Function" on page 21-1.

Example: If the user and security group for a part are set as follows:

User Name	 User1	 User2
Security Group	None	Group A

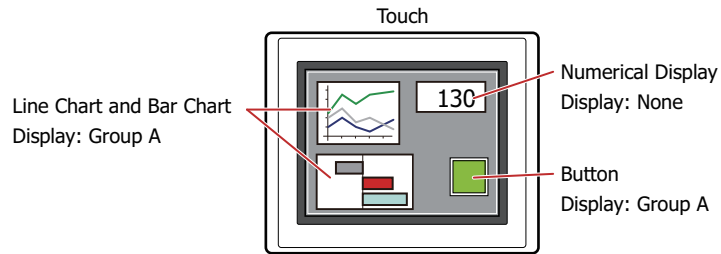

For User 1, who is not included in the specified security group, Group A parts are not displayed.

If the Password Screen is now opened and a switch is made to User 2 of Group A, Group A parts are displayed.

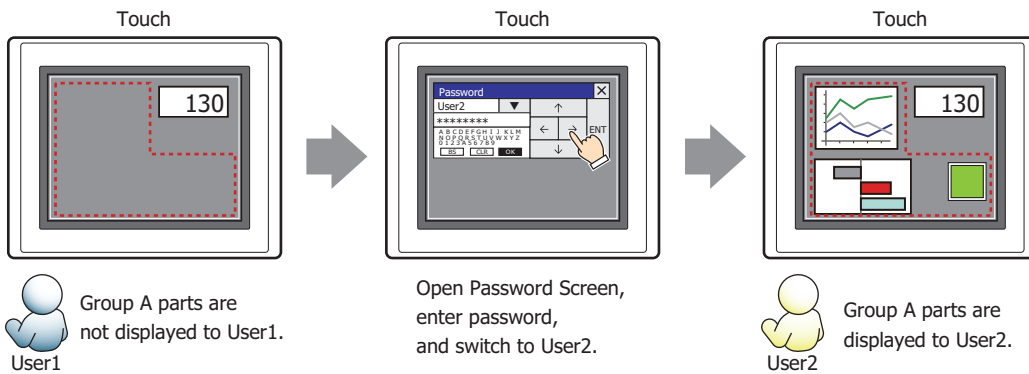

● Comment Tab

The **Comment** tab is used to specify the parts arranged on the editing screen, and the popup text displayed when the mouse pointer is placed close to **No.**, **Name**, or **Type** in the object list.



When there are multiple parts of the same shape on the screen, this feature makes it possible to distinguish between the parts without displaying the Properties dialog box for each part, by just mousing over the part.

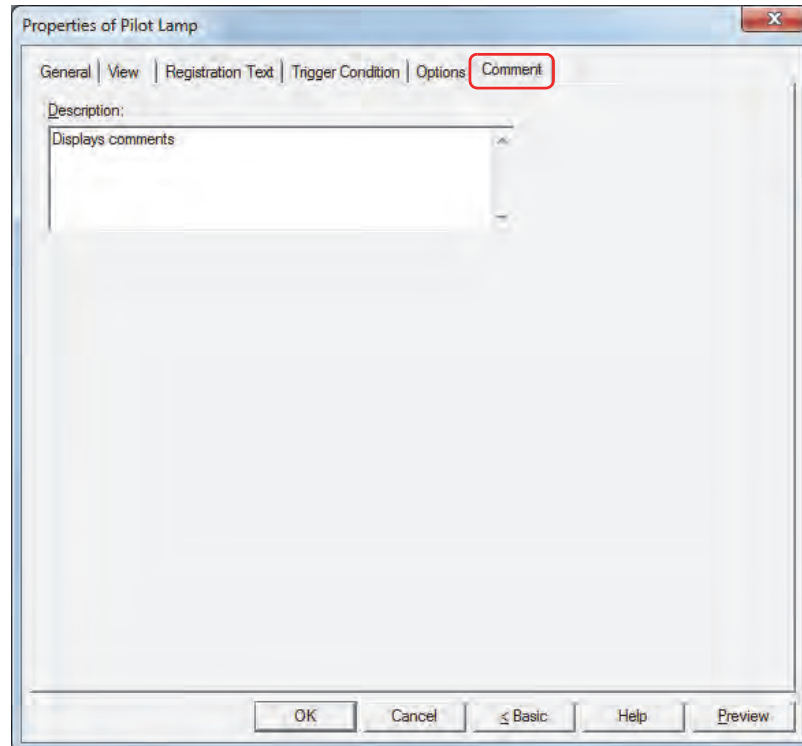

■ Description

Enter a comment about parts. The maximum number is 80 characters.

Example: When mousing over the Pilot Lamp on the editing screen



2 Multi-State Lamps

2.1 How the Multi-State Lamp is Used

Multi-state lamp parts display drawing objects. The value of a specified word device is used to switch the drawing object to be displayed.

- Switch and display pictures by the values of devices

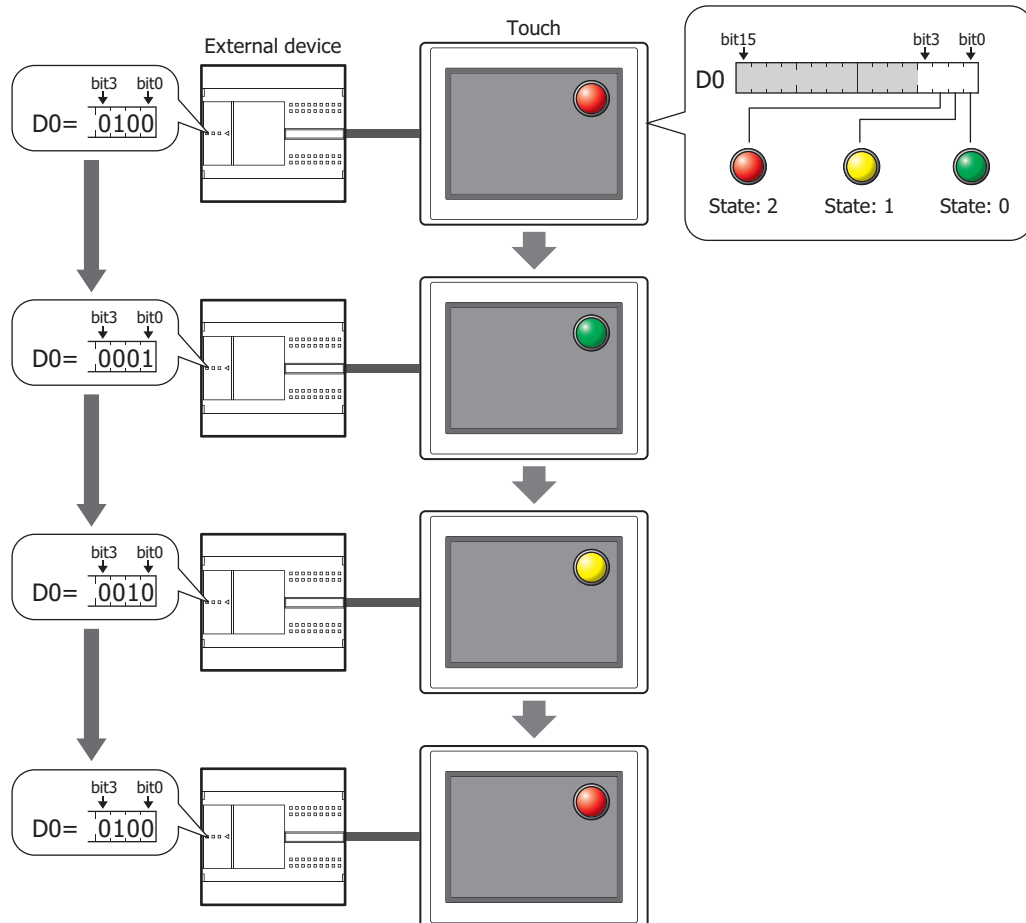

2.2 Multi-State Lamp Configuration Procedure

This section describes the configuration procedure for Multi-State Lamps.

- 1 On the **Home** tab, in the **Parts** group, click **Lamps**, and then click **Multi-State Lamp**.

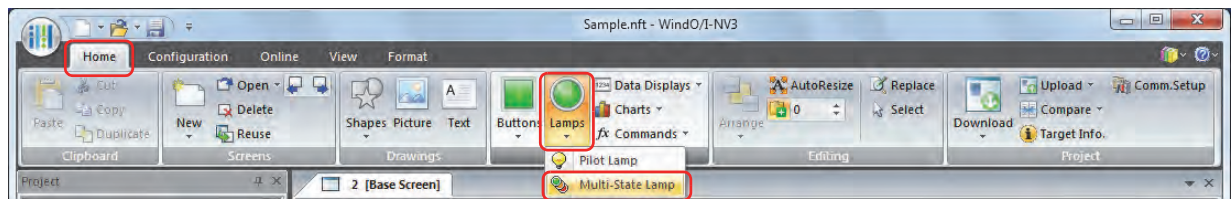

- 2 Click a point on the edit screen where you want to place the Multi-State Lamp.
- 3 Double-click the dropped Multi-State Lamp and a Properties dialog box will be displayed.
- 4 Change the settings on each tab as necessary.

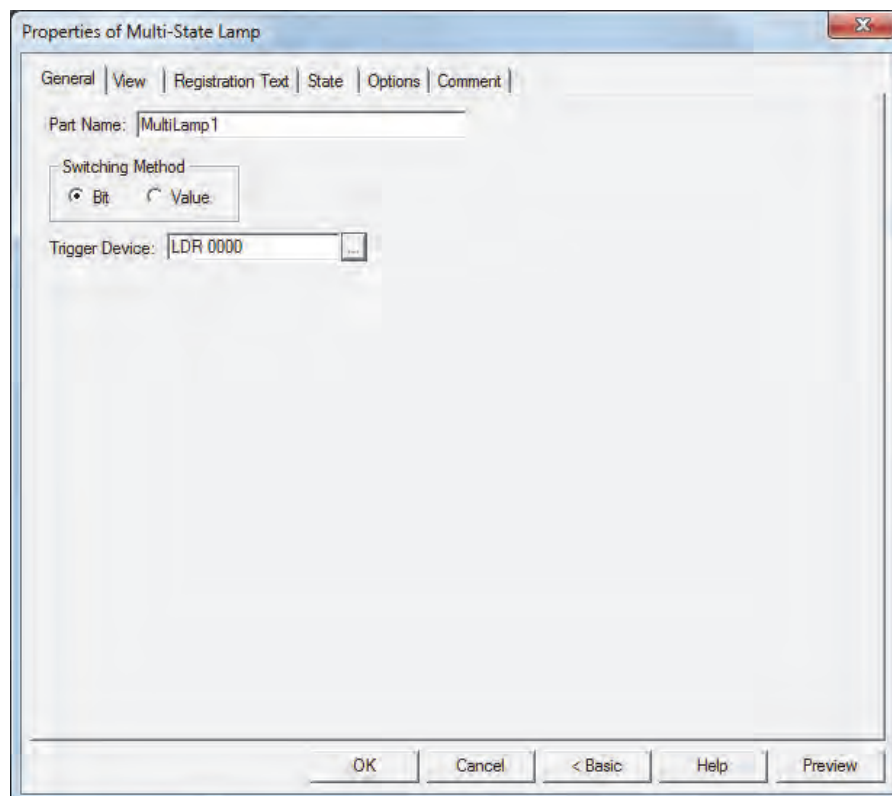

The **Options** tab only appears in Advanced mode.
To switch to Advanced mode, click **Advanced**.

2.3 Properties of Multi-State Lamp Dialog Box

This section describes items and buttons on the properties dialog box.

● General Tab

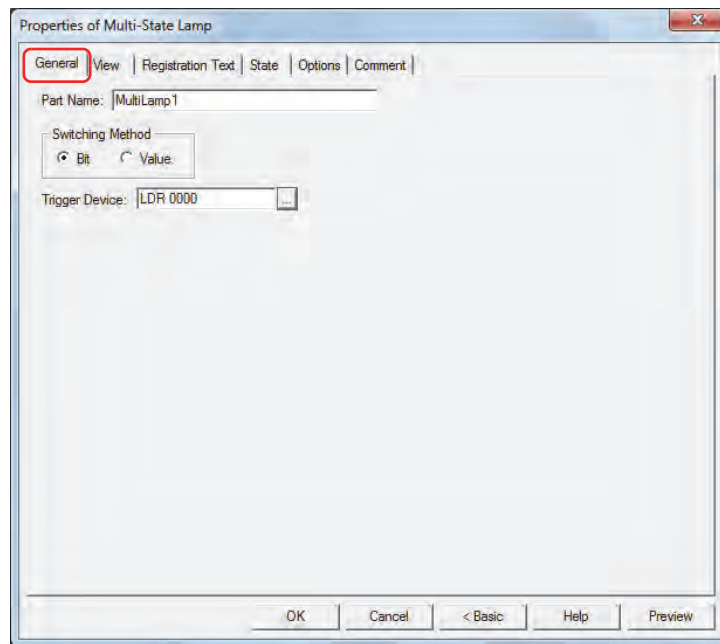

■ Part Name

Enter a name for the part. The maximum number is 20 characters.

■ Switching Method





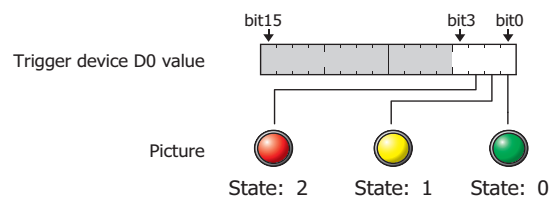

Specify the method to switch drawing objects from the following:

Bit: Switches the drawing object displayed, according to the status of the bits.

Example: When **Bit** is selected and the bits of trigger device D0 are allocated to the following pictures.



Switches the picture to display according to the status of the bits.



Trigger device D0 bit state	0001	0010	0100	1000	1110	1100
Picture to display	 State: 0	 State: 1	 State: 2		 State: 1	 State: 2
Action	Display picture for bit 0	Display picture for bit 1	Display picture for bit 2	No picture	Display picture for bit 1	Display picture for bit 2

If multiple bits are 1, display the picture for the lowest order bit.



If all bits in the device are 0 or if a bit with no associated picture becomes 1, display nothing.

Value: Switches the drawing object displayed, according to the value of the device.

Example: When **Value** is selected and the values of Trigger Device D0 are allocated to the following pictures.

Trigger device D0 value	0	1	2
Picture			
	State: 0	State: 1	State: 2

Switches the picture to display according to the value of the device.

Trigger device D0 value	0	1	2	3
Picture to display	 State: 0	 State: 1	 State: 2	
Action	Display picture for 0	Display picture for 1	Display picture for 2	No picture

If the value of device has no picture associated with it, display nothing.

■ Trigger Device

Specifies the word device to use as the condition for switching the drawing object.

Click  to display the Device Address Settings dialog box. For the device address configuration procedure, refer to Chapter 2 "5.1 Device Address Settings" on page 2-61.

● **View Tab**

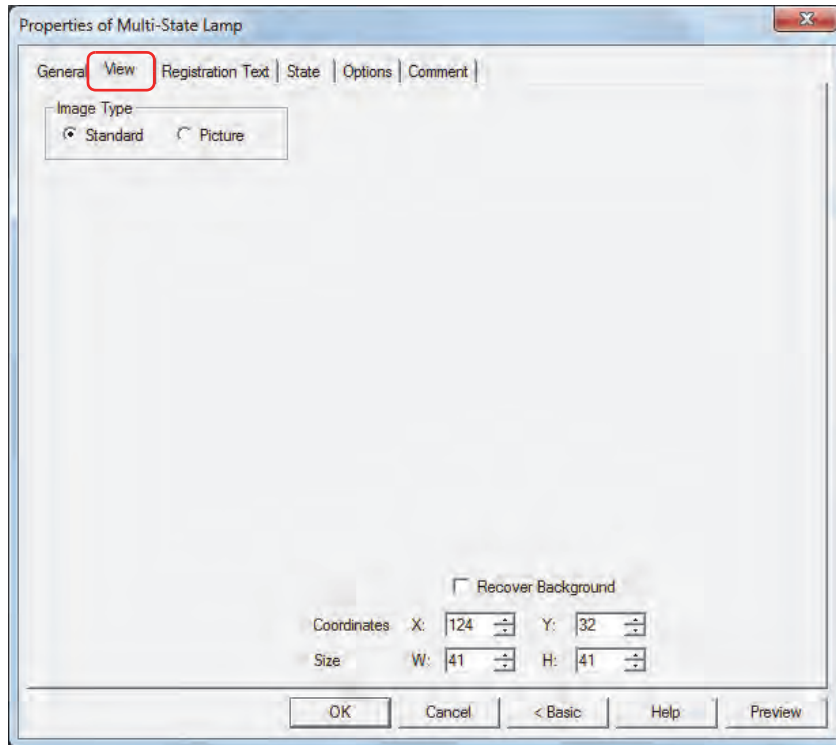

■ **Image Type**

Select the type of graphic to be used to represent the part.

Standard: Uses the default graphic for WindO/I-NV3.

Picture: Uses an image file saved using Picture Manager.

For details about image file restrictions, refer to Chapter 2 "1.4 Available Image Files" on page 2-18.

■ **Recover Background*1**

Select this check box to recover the background of the area where the picture had been displayed after the picture is switched. When this check box is cleared, the background is filled with the screen's **Background Color**.

When parts or drawings are arranged so they overlap the background of the Multi-State Lamp (below), the background of parts and drawings is displayed as follows if the Multi-State Lamp picture is hidden.

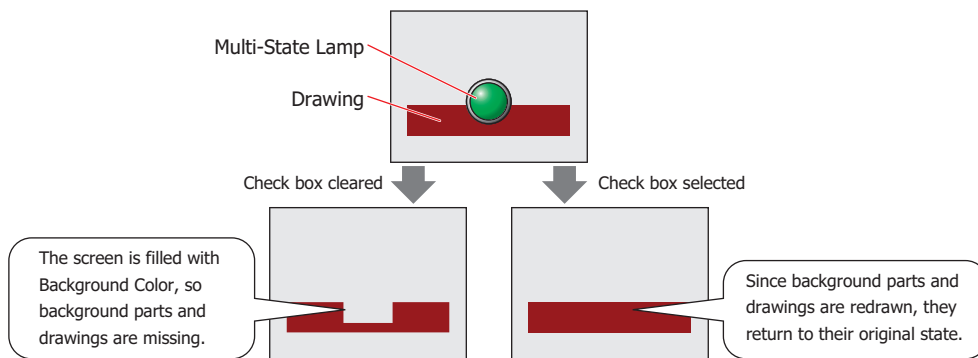

Can only be set when **Picture** is selected for **Image Type**.

However, when the background part is the Alarm List Display, Alarm Log Display, bar chart, line chart, or pie chart, the missing sections will remain.

 If the **Recover Background** check box is selected, the number of parts that can be placed on a single screen decreases. If an error message appears when the Multi-State Lamp is displayed on the Touch, clear the **Recover Background** check box or reduce the number of parts.

*1 Advanced mode only

■ Coordinates

- X, Y: Sets the display position of parts using coordinates.
 The X and Y coordinates of parts is defined relative to an origin at the top-left corner of the screen.
- X: 0 to (Base Screen horizontal size - 1)
- Y: 0 to (Base Screen vertical size - 1)

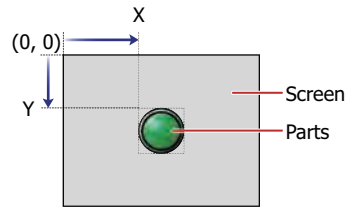

■ Size

- W, H: Sets width and height to define the size of parts.
- W: 5 to (Base Screen horizontal size)
- H: 5 to (Base Screen vertical size)

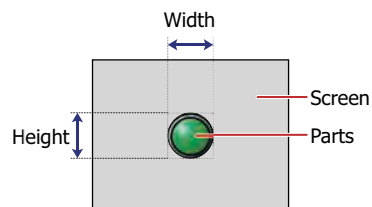

● Registration Text Tab

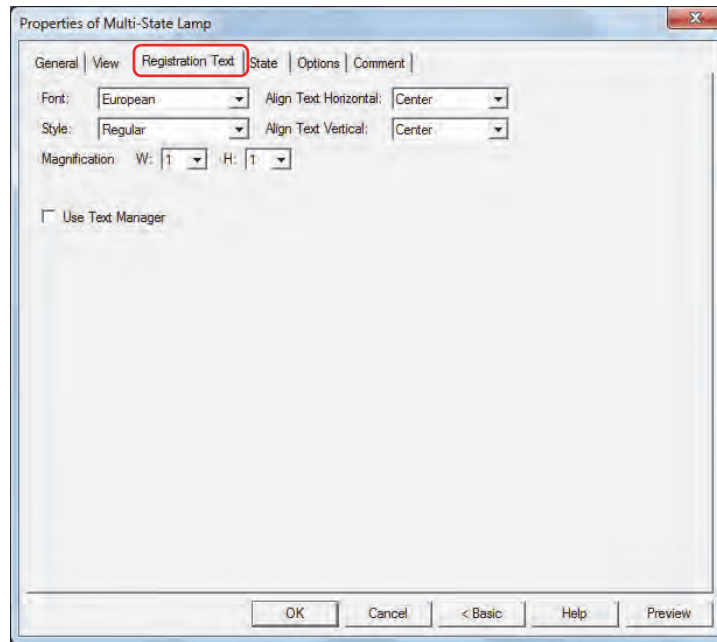

■ Font

Selects the font used for displaying text from the following.

Japanese, European, Chinese, Taiwanese, Korean, Central European, Baltic, Cyrillic, Windows

Can only be set when the **Use Text Manager** check box is cleared.

The characters that can be displayed depend on the font. For details, refer to Chapter 2 “1.2 Available Text” on page 2-5.

■ Style

Selects **Regular** or **Bold** for text style.

Can only be set when **Font** is set to **Japanese, European, Chinese, Taiwanese, Korean, Central European, Baltic** or **Cyrillic**.

■ Magnification

W, H: Selects the magnification (0.5, 1 to 8) for text display.

Can only be set when **Font** is set to **Japanese, European, Chinese, Taiwanese, Korean, Central European, Baltic** or **Cyrillic**.

■ Align Text Vertical

Selects text alignment in the vertical direction.

Top, Center, Bottom

For details, refer to Appendix “5 Text Alignment” on page A-5.

■ Align Text Horizontal

Selects text alignment in the horizontal direction.

Left, Center, Right, Center-Left

For details, refer to Appendix “5 Text Alignment” on page A-5.

■ Set by State

Select this check box if displaying different text when ON and OFF.

■ Use Text Manager

Select this check box if using the text registered in Text Manager for text display.

● State Tab

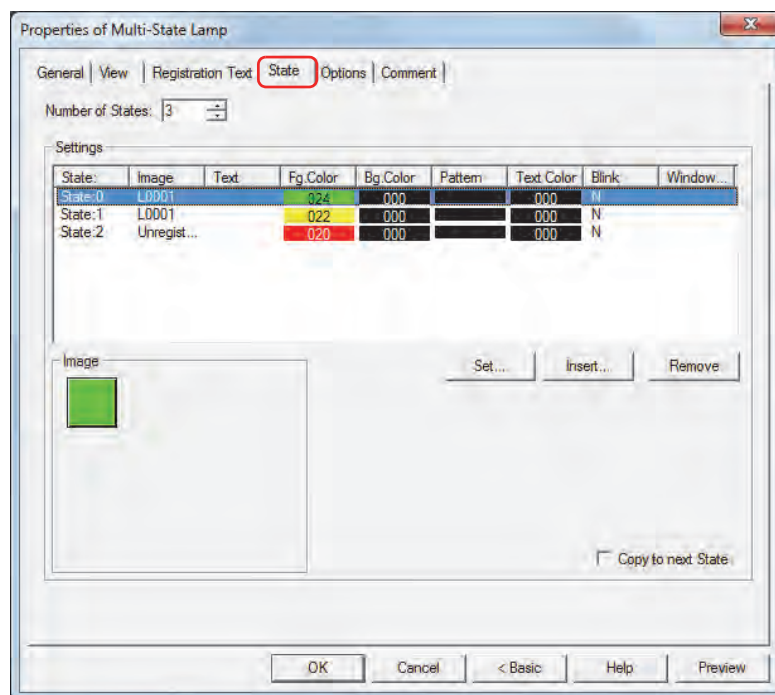

■ Number of States

Specify the number of drawing objects (1 to 16) to display by switching.

■ Settings

Lists the state settings. The list shows various settings such as the state number and file name for the drawing object.

- State:** Shows the state number. Double clicking the cell displays the State Settings dialog box where you can edit the state settings. For details, refer to “State Settings dialog box” on page 8-22.
- Image:** Shows the name or a file name for a drawing object. Double clicking the cell opens the View Browser if **Standard** is selected under Image Type on the **View** tab, or Picture Manager if **Picture** is selected. This allows you to change the drawing object to display.
- Text:** Shows the registration text. Double clicking the cell displays the Unicode Input dialog box. If you selected the **Use Text Manager** check box on the **Registration Text** tab, the Text Manager dialog box will appear. This allows you to change the registration text.
- Fg.Color, Bg.Color:** Shows the foreground and background colors (color: 256 colors, monochrome: 8 shades) for standard images. Double clicking the cell opens the Color Palette where you can change the foreground and background colors. This setting can only be changed if Image Type is set to **Standard** on the **View** tab.
- Pattern:** Shows the pattern for standard images. Double clicking the cell opens the Pattern Palette where you can change the pattern of the image. This setting can only be changed if Image Type is set to **Standard** on the **View** tab.
- Text Color** Shows the color of the registration text. Double clicking the cell opens the Color Palette where you can change the color of the text.
- Blink:** Indicates whether to display the drawing object blinking or constantly lit. Double clicking the cell toggles between **Y** for yes and **N** for no.
- Windows Font:** Shows the currently set Windows Font. Double clicking the cell displays the Font Settings dialog box where you can change the Windows Font. This setting can only be changed when **Windows** is selected for **Font** on the **Registration Text** tab.
- Set:** Registers the state settings to the list. If you select a state number that is already registered, that number is overwritten with the new settings. Click this button to display the State Settings dialog box. For details, refer to “State Settings dialog box” on page 8-22.
- Insert:** Inserts the settings in the position selected on the list. Select a state number in the list, and then click this button to display the State Settings dialog box. The settings at the insertion point shift down one line. Settings cannot be inserted if all state numbers are configured.
- Remove:** Deletes the registered settings from the list. Select a state number, and then click this button to delete the selected settings from the list.

■ Image

Shows the image for the state number selected in the **Settings** list.

■ Copy to next State

Select this check box to register or change all state settings at once.

This option copies the current settings to all state numbers after the selected state number when the settings are set or changed.

State Settings dialog box

This dialog box sets the drawing object and registration text to display.

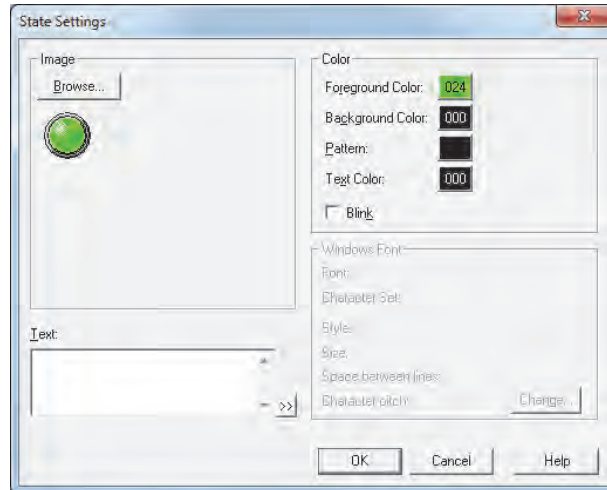

■ Image

Browse: Select the drawing object to use for the lamp part. Clicking this button opens the View Browser if **Standard** is selected under Image Type on the **View** tab, or Picture Manager if **Picture** is selected.

Image: Shows the selected drawing object.

■ Text

Enter the text to display. The maximum number is 3,750 characters.

The characters that can be entered depends on the font selected for **Font** on the **Registration Text** tab. For details, refer to Chapter 2 "1.2 Available Text" on page 2-5.

This setting is only enabled when the **Use Text Manager** check box is cleared on the **Registration Text** tab.

■ Text ID

To use the text registered in Text Manager, specify the ID number from 1 to 32000.

This setting is only enabled when the **Use Text Manager** check box is selected on the **Registration Text** tab.

■ Color

Foreground Color, Background Color:

Select the foreground and background color to use for standard images (color: 256 colors, monochrome: 8 shades).

Clicking either button opens the Color Palette. Select a color from the Color Palette.

Pattern:

Select the pattern for a standard image. Clicking this button opens the Pattern Palette. Select a pattern from the Pattern Palette.

Text Color:

Select the text color (color: 256 colors, monochrome: 8 shades) for the registration text. Clicking this button opens the Color Palette. Select a color from the Color Palette.

Blink:

Select this check box to cause the image to blink (alternately display the ON and OFF drawing object at fixed time interval).

The blinking interval can be set with the **Blinking Cycle** setting on the **System** tab of the Project Settings dialog box.

■ Windows Font

Specify the Windows Font to use.

The current settings are displayed by selecting **Windows** in the **Font** property on the **Registration Text** tab. To change the settings, click **Change** to display the Font Settings dialog box.

The text ID setting is only enabled if the **Use Text Manager** check box is cleared.

For details, refer to Chapter 2 "Windows Font" on page 2-12.

● Options Tab

The **Options** tab is displayed in Advanced mode.

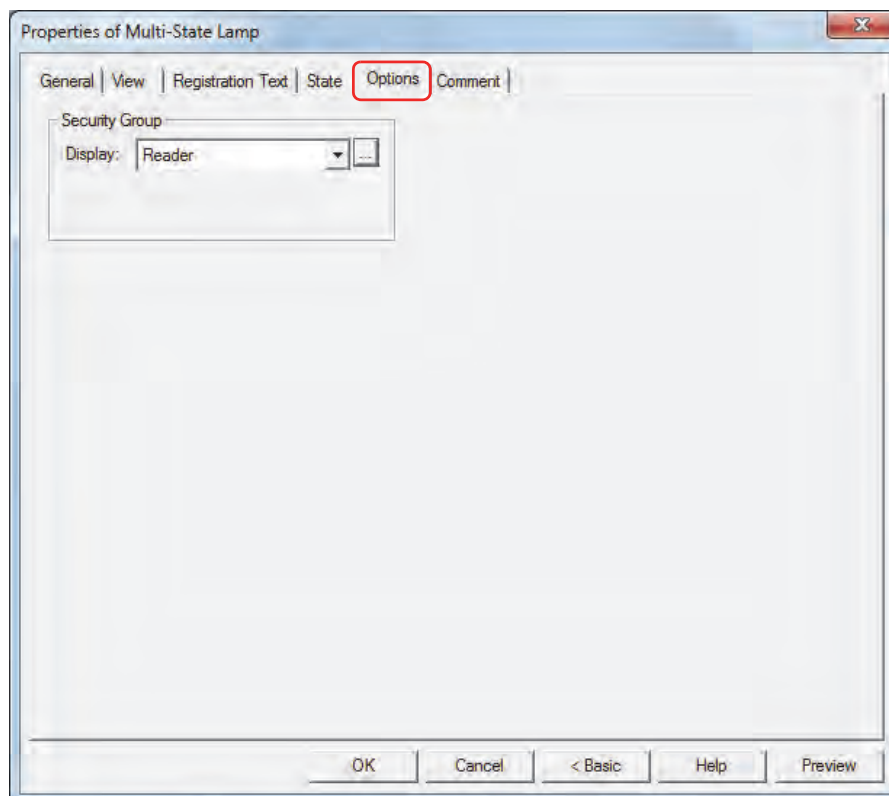

■ Security Group

Security groups are a security function for restricting the display and operation of parts.

Display: Selects the security group for which display of parts is restricted. (Default: None)

None: No security function is used.



Administrator, Operator, Reader: Three security groups are set up by default.

Click  to display the Security Group Settings dialog box. If you create a security group on the Security Group Settings dialog box, you can select that created group. For details, refer to Chapter 21 "2.2 Adding and Editing Security Groups" on page 21-15.



For details about security functions, refer to Chapter 21 "User Accounts and the Security Function" on page 21-1.

Example: If the user and security group for a part are set as follows:

User Name	 User1	 User2
Security Group	None	Group A

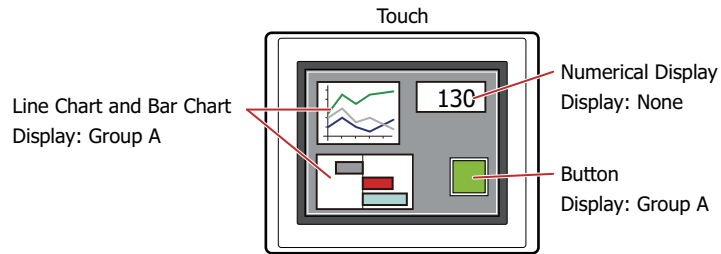

For User 1, who is not included in the specified security group, Group A parts are not displayed.

If the Password Screen is now opened and a switch is made to User 2 of Group A, Group A parts are displayed.

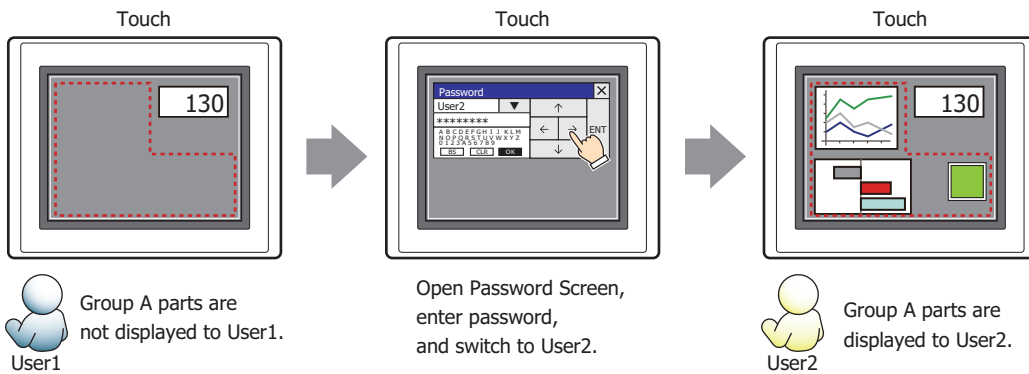

● Comment Tab

The **Comment** tab is used to specify the parts arranged on the editing screen, and the popup text displayed when the mouse pointer is placed close to **No.**, **Name**, or **Type** in the object list.



When there are multiple parts of the same shape on the screen, this feature makes it possible to distinguish between the parts without displaying the Properties dialog box for each part, by just mousing over the part.

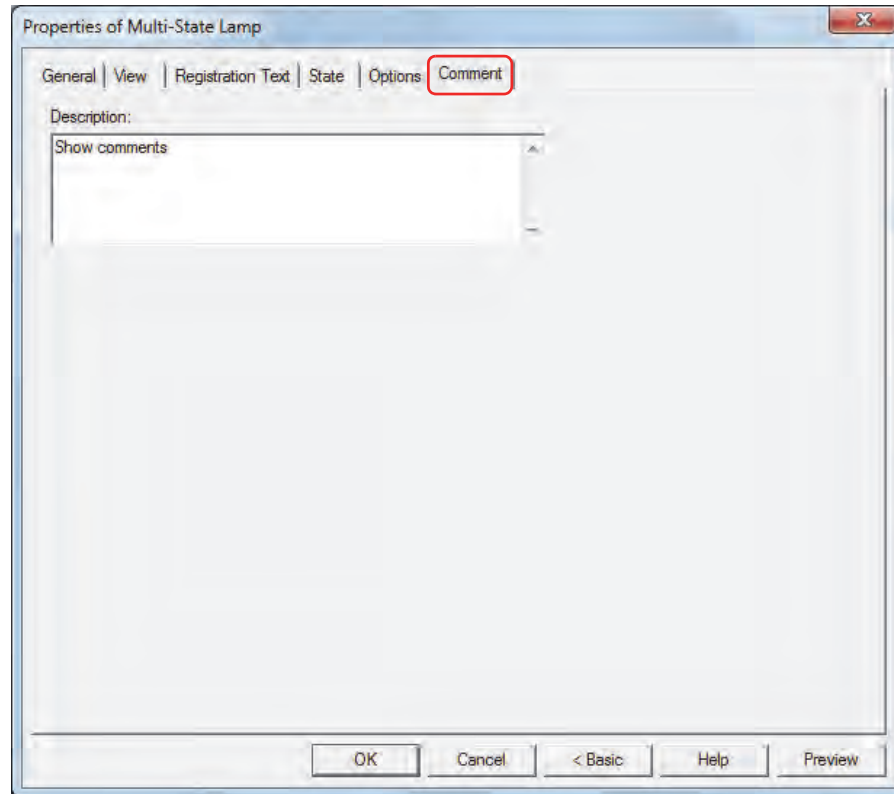

■ Description

Enter a comment about parts. The maximum number is 80 characters.

Example: When mousing over the Multi-State Lamp on the editing screen

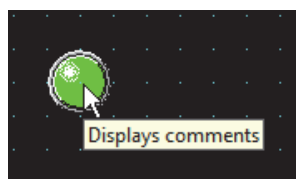

Chapter 9 Data Displays

This chapter describes how to configure the Data Display parts and their operation on the Touch.

1 Numerical Input

1.1 How the Numerical Input is Used

The Numerical Input features a display mode that displays the current value of device and an entry mode that enters a value using the keypad or key buttons and writes that value to a device. When the part is displayed on the screen, the Numerical Input is in display mode. To enter a value by pressing the keypad or key buttons, touch the Numerical Input to switch it to entry mode. In entry mode, the value of device is displayed until a value is entered.

The Numerical Input can perform the following functions.

- Write a value entered with the keypad or key buttons to a device

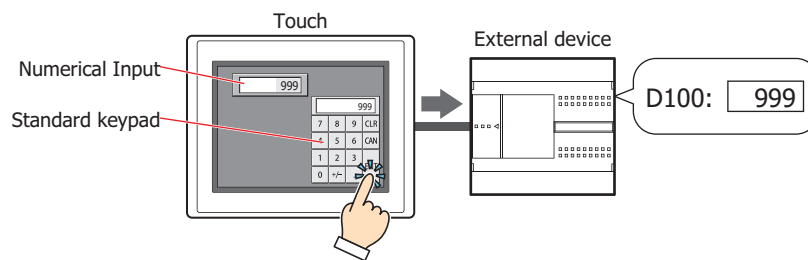

- Display the current value of device

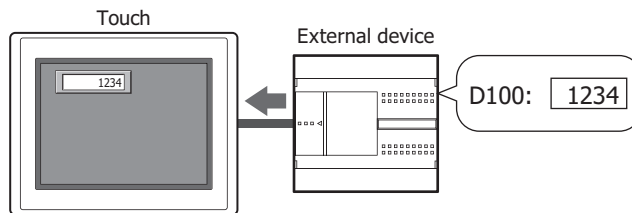

- Enter and display decimal numbers

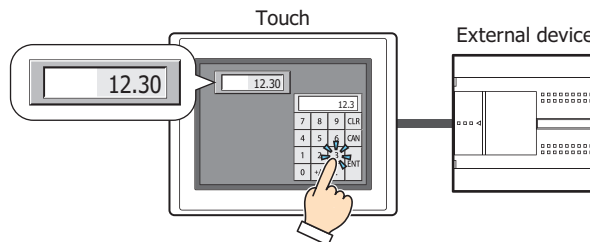

- Display the entered value as * (asterisk)

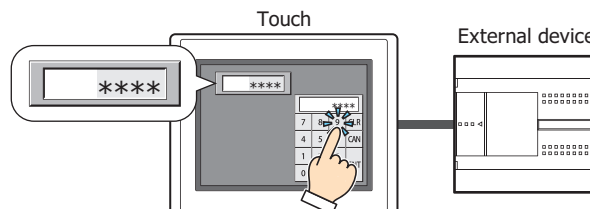

1.2 Numerical Input Configuration Procedure

This section describes the configuration procedure for Numerical Inputs.

- 1 On the **Home** tab, in the **Parts** group, click **Data Displays**, and then click **Numerical Input**.

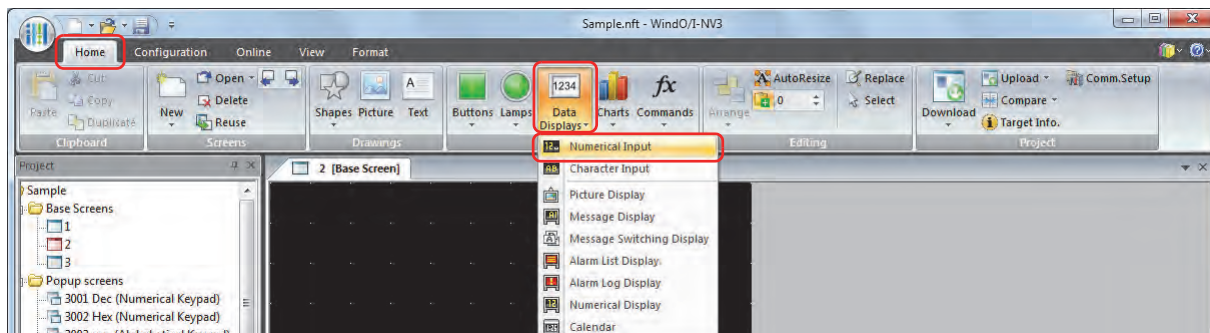

- 2 Click a point on the edit screen where you want to place the Numerical Input.
- 3 Double-click the dropped Numerical Input and a Properties dialog box will be displayed.
- 4 Change the settings on each tab as necessary.

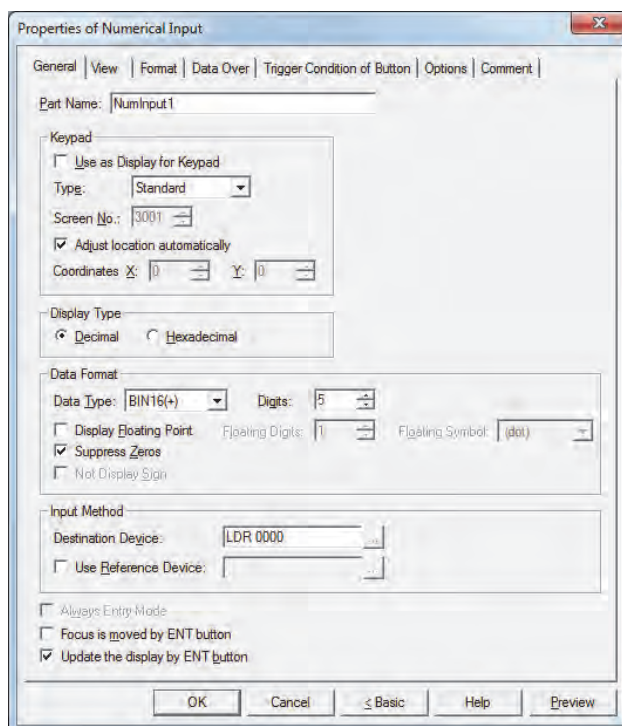

The **Data Over** tab, **Trigger Condition** tab and **Options** tab only appear in Advanced mode. To switch to Advanced mode, click **Advanced**.

1.3 Properties of Numerical Input Dialog Box

This section describes items and buttons on the properties dialog box.

● General Tab

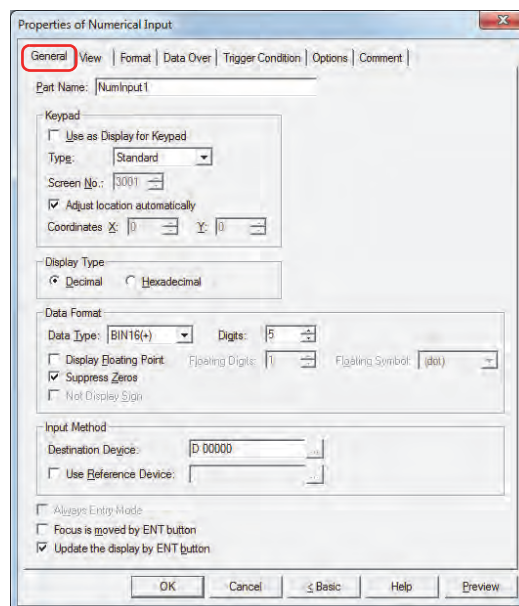

■ Part Name

Enter a name for the part. The maximum number is 20 characters.

■ Keypad

Configures the keypad for entering values in the Numerical Input.

Use as Display for Keypad^{*1}: Select this check box to only use the Numerical Input as a part to display the value entered with the keypad.

Type: According to the location where the keypad is configured, selects the type from the following.

Standard: Uses the standard keypad. The standard keypad is the keypad configured as the Popup Screen for the standard keypad (screen number 3000 to 3015). This is the keypad for the type configured by **Display Type**.

Popup: Uses a keypad configured as a Popup Screen.

Current Screen: Uses the keypad configured on the same screen as the Numerical Input.

Screen No.: Specifies the screen number of the Popup Screen configured as the keypad (1 to 3015). This option can only be configured if **Popup** is selected for **Type**.

Adjust location automatically: Select this check box to display the Popup Screen configured as the keypad in a location where it will not overlap the Numerical Input. This option can only be configured if **Standard** or **Popup** is selected for **Type**.

Coordinates X, Y: Specifies the display location of the Popup Screen configured as the keypad. With the upper-left corner of the screen as the origin, the X and Y coordinates are the upper-left corner of the Popup Screen. This option can only be configured when **Popup** is selected for **Type** and the **Adjust location automatically** check box is cleared. Specify the coordinates in 1 dot units.
X: 0 to (Base Screen horizontal size - 1)
Y: 0 to (Base Screen vertical size - 1)

*1 Advanced mode only

■ **Display Type**

Selects the display type for the value as **Decimal** or **Hexadecimal**.

■ **Data Format**

Data Type: Selects the type of data for the value.

The data type that can be configured differs according to **Display Type**. For the data types that can be configured, see the table for **Digits**.

For details, refer to Chapter 2 “1.1 Available Data” on page 2-1.

Digits: Specifies the digits to display. The range of digits that can be set varies based on the display type and data type. The digits that can be set are as follows.

Display Type	Data Type	Digits
Decimal display	BIN16 (+), BIN16 (+/-)	1 to 5
	BIN32 (+), BIN32 (+/-)	1 to 10
	BCD4	1 to 4
	BCD8	1 to 8
	float32	1 to 10
Hexadecimal display	BIN16 (+)	1 to 4
	BIN32 (+)	1 to 8

Display Floating Point: Select this check box to display the decimal point.



If **Data Type** is **BIN16(+)**, **BIN16(+/-)**, **BIN32(+)**, **BIN32(+/-)**, **BCD4**, or **BCD8** and the **Display Floating Point** check box is selected, a decimal value will be displayed on the Numerical Input when a decimal value is entered on the keypad in entry mode, but an integer is written to the device. In display mode, source data is an integer, but the value is displayed with a decimal point added at the number of floating digits configured for the Numerical Input.

However, if **float32** is selected for **Data Type**, both the destination data and the source data are decimal values.

Example: When **Display Type** is configured as **Decimal**, **Data Type** is **BIN16(+)**, the **Display Floating Point** check box is selected, **Digits** is 5, **Floating Digits** is 3, and **Destination Device** is D100

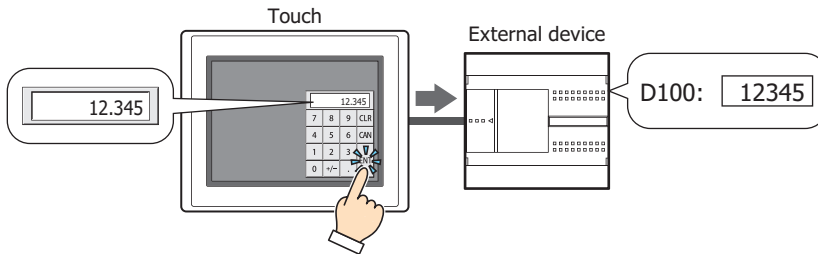

Floating Digits: Specifies the number of digits for the fractional part of the decimal value out of the number of digits specified by **Digits**.

This option can only be configured when the **Display Floating Point** check box is selected. The range of digits that can be set for the fractional part varies based on the display type and data type. The range of digits that can be set for the fractional part is as follows.

Display Type	Data Type	Floating Digits
Decimal display	BIN16 (+), BIN16 (+/-)	1 to Digits
	BIN32 (+), BIN32 (+/-)	1 to Digits
	BCD4	1 to Digits
	BCD8	1 to Digits
	float32	1 to 8
Hexadecimal display	BIN16 (+)	--
	BIN32 (+)	--

Floating Symbol*1: Selects the decimal point symbol from the following.
.(dot), :(colon), ;(semicolon), ,(comma), /(slash)
 This option can only be configured when the **Display Floating Point** check box is selected.
 Example: When **Digits** is 4 and **Floating Digits** is 2
 When **Floating Symbol** is **.(dot)** 12.34
 When **Floating Symbol** is **/(slash)** 12/34



Floating Symbol is not reflected on the standard keypad. To change the decimal point symbol on the standard keypad, please change the keypad button.

Suppress Zeros: Select this check box to hide "0" for the upper digits of the integer part.
 Example: **Suppress Zeros** selected: 1234
Suppress Zeros cleared: 00001234

Not Display Sign: Select this check box to hide the - (negative) symbol when displaying negative values.
 This option can only be configured when **Data Type** is **BCD4**, **BCD8**, or **float32**.

■ **Input Method**

These options specify the destination for entered values.

Destination Device: Specifies the word device to write the entered value to.
 Click to display the Device Address Settings dialog box. For the device address configuration procedure, refer to Chapter 2 "5.1 Device Address Settings" on page 2-61.

Use Reference Device*1: Select this check box and specify a device to change the destination word device by the value of this device.
 Click to display the Device Address Settings dialog box. For the device address configuration procedure, refer to Chapter 2 "5.1 Device Address Settings" on page 2-61. For details on indirect writing, refer to Chapter 2 "Indirect Read and Indirect Write Settings" on page 2-4.

■ **Always Entry Mode*1**

Select this check box to enter values by pressing the keypad and key buttons without touching the Numerical Input displayed on the screen.

To display 0 on the Numerical Input until a value is entered, select the **Start from 0 in Always Entry Mode of Numerical Input** check box on the **System** tab in the Project Settings dialog box. To display the value of device, clear the **Start from 0 in Always Entry Mode of Numerical Input** check box.

This option can only be configured if **Current Screen** is selected for **Type**.

Example: When the **Always Entry Mode** check box is selected and the **Start from 0 in Always Entry Mode of Numerical Input** check box is selected on the **System** tab in the Project Settings dialog box

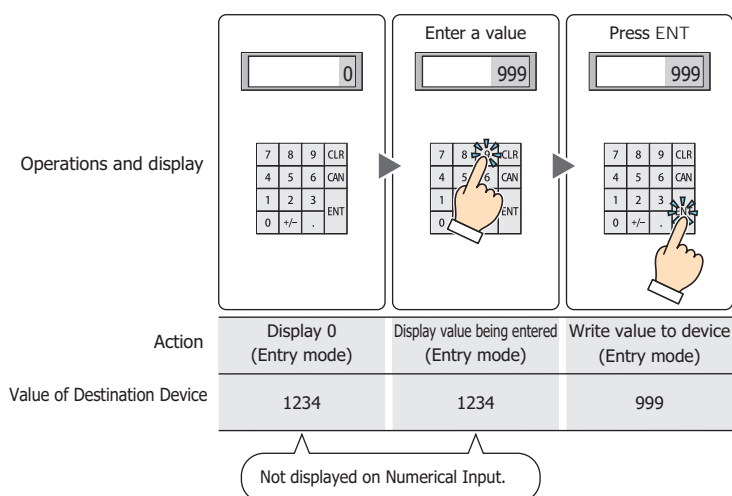

Only one Numerical Input or one Character Input set to **Always Entry Mode** can be configured on a single screen.

*1 Advanced mode only

Example: When the **Always Entry Mode** check box is cleared

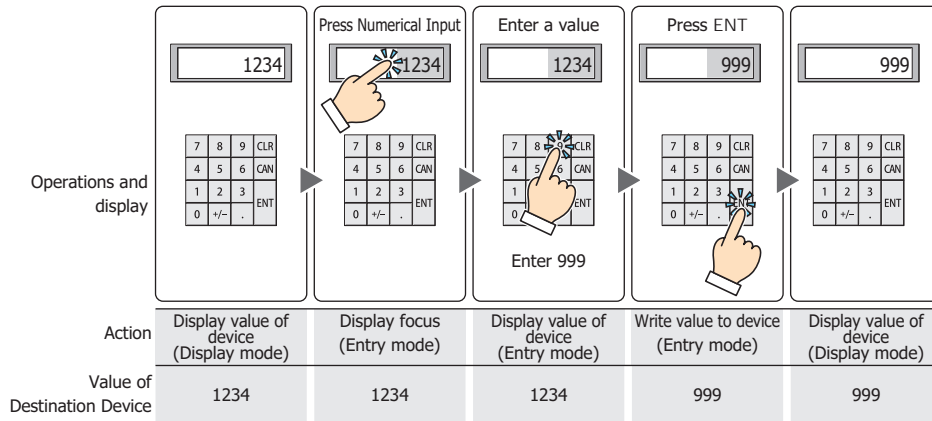

■ **Focus is moved by ENT button***1

When multiple Numerical Inputs are configured on the screen, select this check box to continue entering values on each of the Numerical Inputs.

Each time **ENT** is pressed, the focus moves between the Numerical Inputs according to **Focus Order**. On the **View** tab, in the **Screens** group, click **Focus Order**, and then click the Numerical Inputs in the order to move the focus.

Example: When Numerical Input A and B are configured and the **Focus is moved by ENT button** check box for Numerical Input A is selected and the **Focus is moved by ENT button** check box for Numerical Input B is cleared

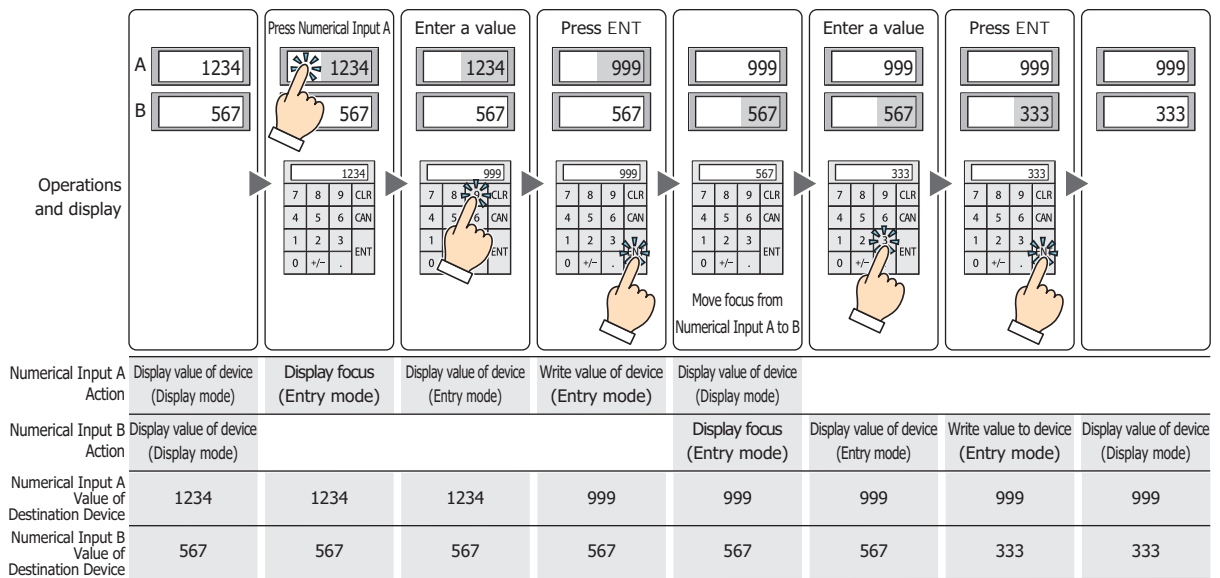

*1 Advanced mode only

■ **Update the display by ENT button *1**

Select this check box to display the current value unchanged and update the display when a value is entered and **ENT** is pressed.

When this check box is cleared, the display updates with each press of a number button to display the number being entered.

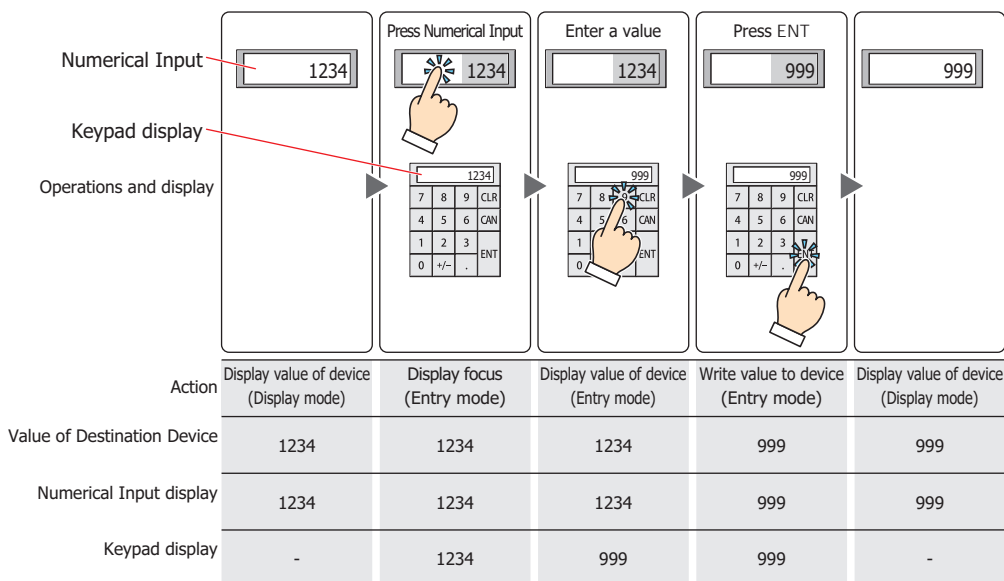

When a value outside the input range is entered and **ENT** is pressed, “?” is shown in the display. The value is not written to the device.

*1 Advanced mode only

● **View** Tab



■ **Browse**

Select the type of graphic to represent the part from the list of graphics. Click this button to display the View Browser.

■ **Plate Color**

Selects the plate color of the standard graphic (color: 256 colors, monochrome: 8 shades).

Click the **Color** button to display the Color Palette. Select a color from the Color Palette.

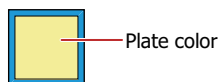

■ **Flange**

Foreground Color, Background Color:

Selects the foreground and background colors of the flange of the standard graphic (color: 256 colors, monochrome: 8 shades).

Click the **Color** button to display the Color Palette. Select a color from the Color Palette.

Pattern:

Selects a pattern for the flange of the standard graphic.

Click the **Pattern** button to display the Pattern Palette. Select a pattern from the Pattern Palette.

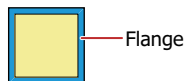

■ Coordinates

- X, Y: Sets the display position of parts using coordinates.
The X and Y coordinates of parts is defined relative to an origin at the top-left corner of the screen.
- X: 0 to (Base Screen horizontal size - 1)
- Y: 0 to (Base Screen vertical size - 1)

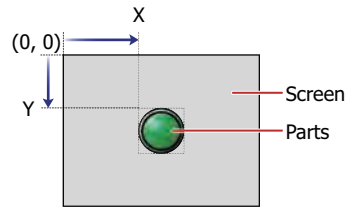

■ Size

- W, H: Sets width and height to define the size of parts.
- W: 20 to (Base Screen horizontal size)
- H: 20 to (Base Screen vertical size)

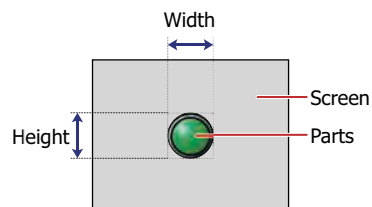

● Format Tab

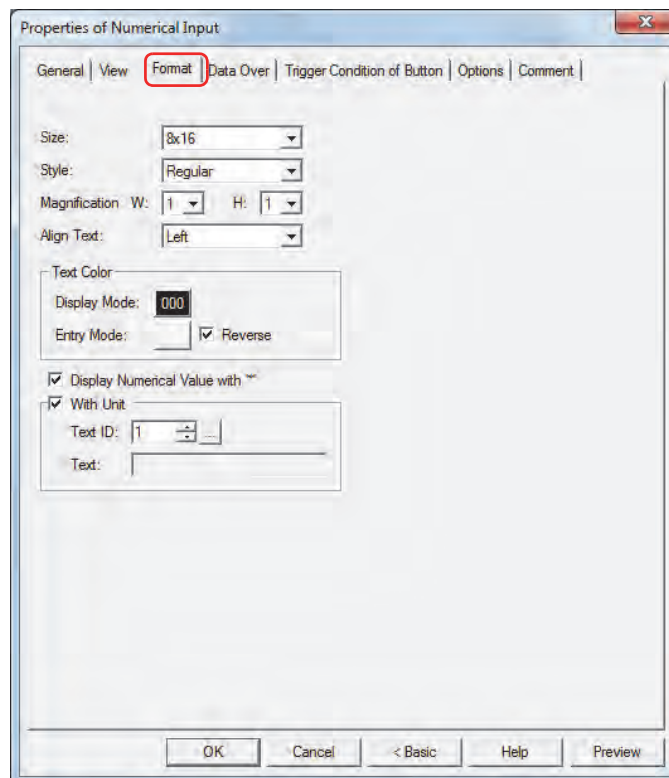

■ Size

Selects the text size as **8x16** or **16x16**.

■ Style

Selects **Regular** or **Bold** for text style.

■ Magnification

W, H: Selects text magnification (0.5, 1 to 8).

■ Align Text

Selects the text alignment in the horizontal direction from the following.

Left, Center, Right

For details, refer to Appendix "5 Text Alignment" on page A-5.

■ Text Color

Selects the color of displayed text (color: 256 colors, monochrome: 8 shades).

Click the **Color** button to display the Color Palette. Select a color from the Color Palette.

This option can configure the text color in display mode and in entry mode. However, for **Entry Mode** text color can be set only when the **Reverse** check box is cleared.

■ Reverse

Select this check box to reverse the text color and plate color during display mode when in entry mode.

■ Display Numerical Value with "*" *1

Select this check box to display the entered value as * (asterisks).

Nothing is displayed if the value of device is 0 when this check box is selected and the **Suppress Zeros** check box is selected on the **General** tab. When this check box is selected in entry mode, nothing is displayed until a value is entered from the key buttons or keypad. If **ENT** is pressed with nothing displayed, 0 is written to the destination device.

■ With Unit*1

Select this check box to display units or other characters at the end of a number. Displayed characters must be registered in Text Manager. The displayed text color will be as set for **Text Color** under the **Format** tab.

Text ID: Specifies the Text Manager ID No. (1 to 32000).

Click to display Text Manager.

Text: Displays the characters of the specified Text ID.



- The maximum number that can be displayed with this function is 4 characters. The fifth and subsequent characters of a character string are not displayed. However, if Windows Font is set for the specified Text ID characters all the characters are displayed.
- If a carriage return (CR) is included the characters after the CR are not displayed.

*1 Advanced mode only

● Data Over Tab

The **Data Over** tab is displayed in Advanced mode.

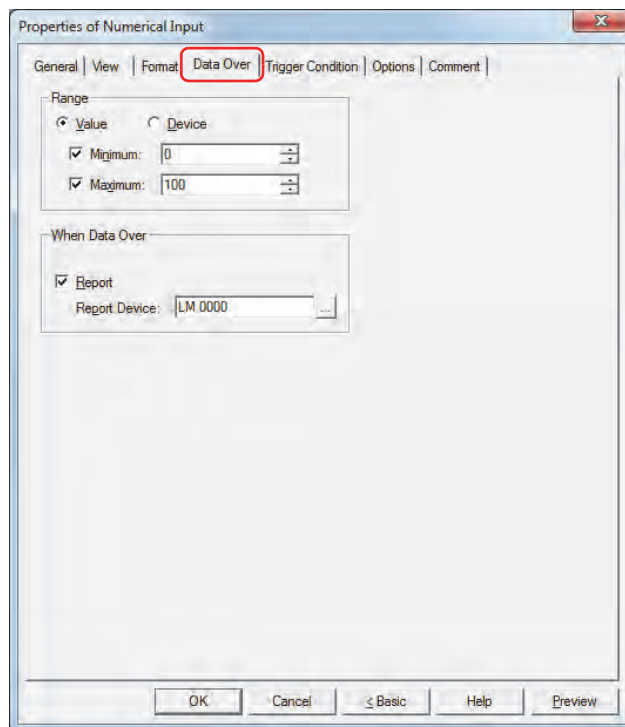

■ Range

Select data type.

Value: Specifies the minimum and/or the maximum as a constant.

Device: Specifies the minimum and/or the maximum as a value of word device.

Specifies the allowable range of values to enter or display.

Minimum, Maximum: Select these check boxes to specify the minimum and/or maximum.

The minimum and maximum that can be specified when **Value** is selected vary based on the data type selected with **Data Format** on the **General** tab. For details on data types, refer to Chapter 2 "1.1 Available Data" on page 2-1.

When **Device** is selected, these options specify the source word devices.

Click  to display the Device Address Settings dialog box. For the device address configuration procedure, refer to Chapter 2 "5.1 Device Address Settings" on page 2-61.



- Select **BIN16(+)**, **BIN16(+/-)**, **BIN32(+)**, **BIN32(+/-)**, **BCD4** or **BCD8** for **Data Type** under the **General** tab, and to display a fractional number specify the values of **Minimum** and **Maximum** as an integer.
Example: To set a value of "1.25" for the upper limit, enter "125".
- If the value of device to display exceeds the data range that can be processed for the data type selected under **Data Format** on the **General** tab, "?" is displayed.
- If the entered value exceeds the allowable range or if it exceeds the data range that can be processed for the data type selected under **Data Format** on the **General** tab, "?" is displayed and the value is not written to the device.

■ When Data Over

These options configure the operation of the part when the value entered with the keypad exceeds the allowable range.

These options can only be configured when the **Minimum** or **Maximum** check boxes are selected under **Range**.

Report: Select this check box and specify the report device to write 1 in this device when the entered data or the value of device to display exceeds the allowable range.

Click  to display the Device Address Settings dialog box. For the device address configuration procedure, refer to Chapter 2 "5.1 Device Address Settings" on page 2-61.

Example: If you attempt to enter "140", which is higher than the maximum of "100", or "-10", which is lower than the minimum of "0", the value is not written and "?" is displayed. 1 is written to **When Data Over** report device LMO.

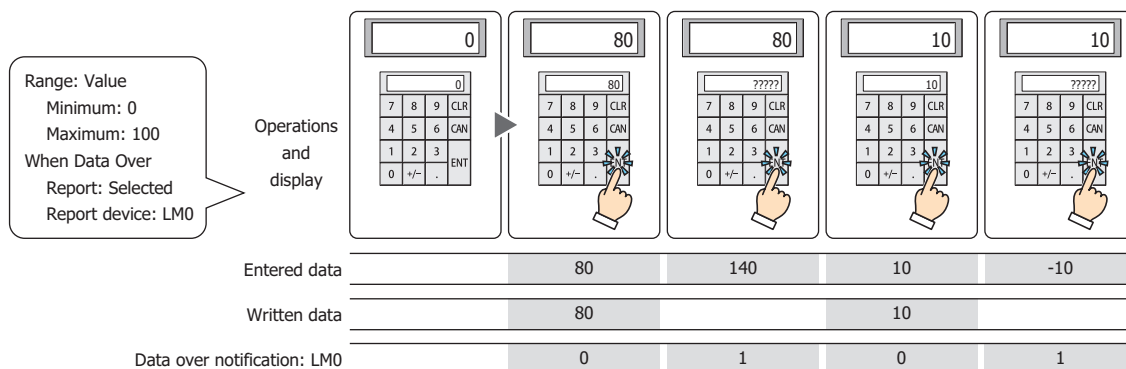

● **Trigger Condition** Tab

The **Trigger Condition** tab is displayed in Advanced mode.

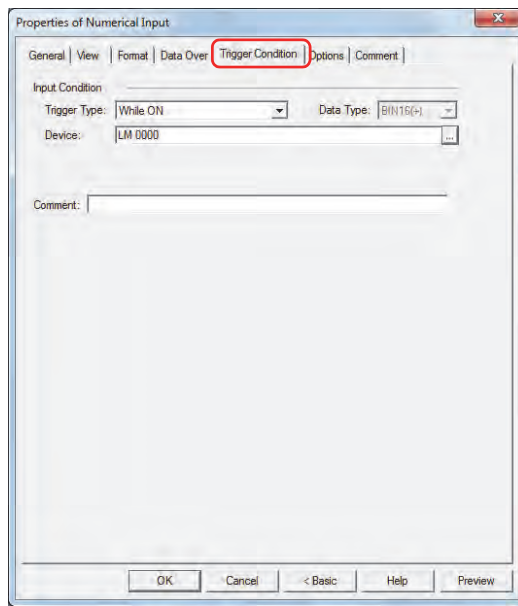

■ **Input Condition**

The Numerical Input is enabled and operational while the condition is satisfied. The Numerical Input is disabled and not operational while the condition is not satisfied.

Example: When **Trigger Type** is **While ON**, **Device** is LM0

While LM0 is 0, the condition is not satisfied and the Numerical Input is not operational.

While LM0 is 1, the condition is satisfied and the Numerical Input is operational.

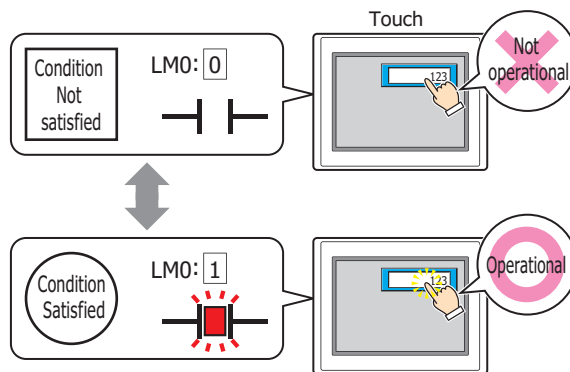

Trigger Type: Selects the condition to enable the Numerical Input from the following.

Always Enabled: The Numerical Input is always enabled.

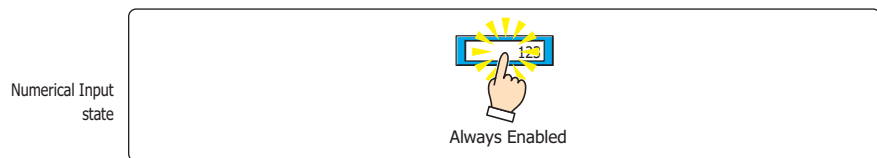

While ON: Enables the Numerical Input when the value of device is 1.

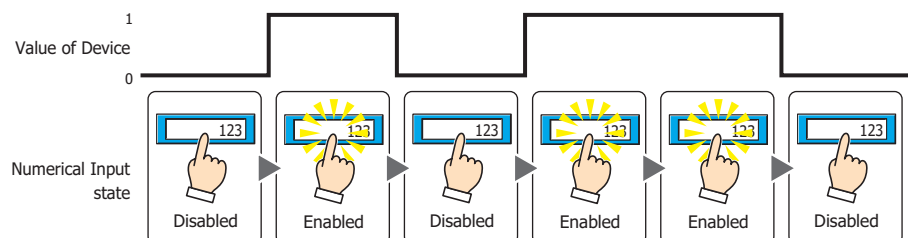

While OFF: Enables the Numerical Input when the value of device is 0.

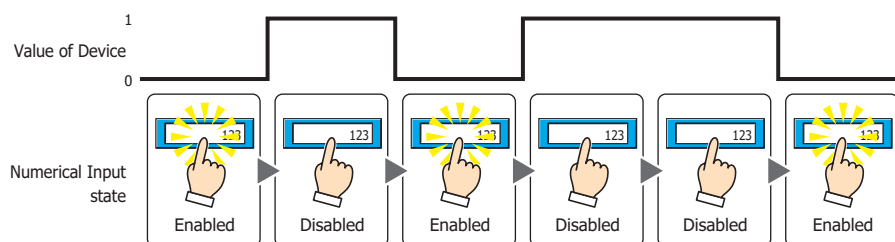

While satisfying the condition:

Enables the Numerical Input when the condition is satisfied.

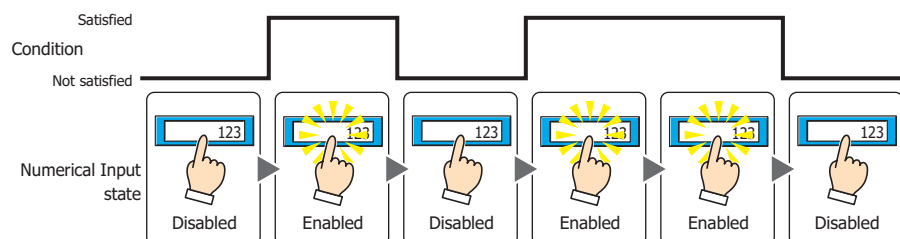

Data Type: Selects the type of data handled by the conditional expression for the input condition. This option can only be configured if **While satisfying the condition** is selected for **Trigger Type**. For details, refer to Chapter 2 “1.1 Available Data” on page 2-1.

Device: Specifies the bit device or bit of the word device to serve as the input condition. This option can only be configured when **While ON** or **While OFF** is selected for **Trigger Type**.

Click to display the Device Address Settings dialog box. For the device address configuration procedure, refer to Chapter 2 “5.1 Device Address Settings” on page 2-61.

Condition: Specifies the conditional expression for the input condition. This option can only be configured when **While satisfying the condition** is selected for **Trigger Type**.

Click to display the Trigger Condition Settings dialog box. For the conditional expression configuration procedure, refer to Chapter 2 “5.2 Setting Conditional Expressions” on page 2-63.

Comment: Enter a comment for the input condition. The maximum number is 80 characters.

● Options Tab

The **Options** tab is displayed in Advanced mode.

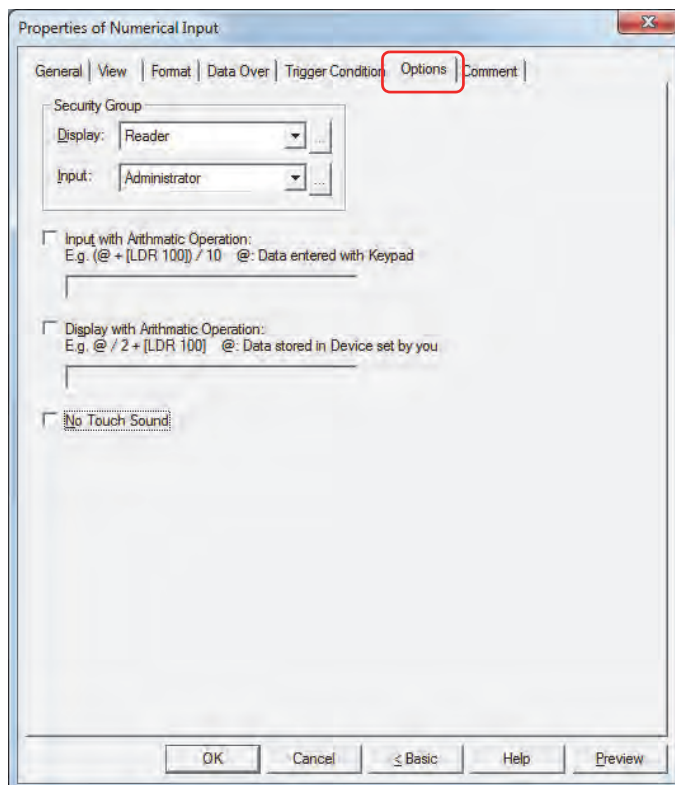

■ Security Groups

Security groups are a security function for restricting the display and operation of parts.

Display: Selects the security group for which display of parts is restricted. (Default: None)

None: No security function is used.

Administrator, Operator, Reader: Three security groups are set up by default.

Click  to display the Security Group Settings dialog box. If you create a security group on the Security Group Settings dialog box, you can select that created group. For details, refer to Chapter 21 "2.2 Adding and Editing Security Groups" on page 21-15.

Input: Selects the security group for which operation of parts is restricted. (Default: None)

None: No security function is used.



Administrator, Operator, Reader: Three security groups are set up by default.

Click  to display the Security Group Settings dialog box. If you create a security group on the Security Group Settings dialog box, you can select that created group. For details, refer to Chapter 21 "2.2 Adding and Editing Security Groups" on page 21-15.



For details about security functions, refer to Chapter 21 "User Accounts and the Security Function" on page 21-1.

Example: If the user and security group for a part are set as follows:

User Name	 User1	 User2	 User3
Security Group	None	Group A	Group A, Group B

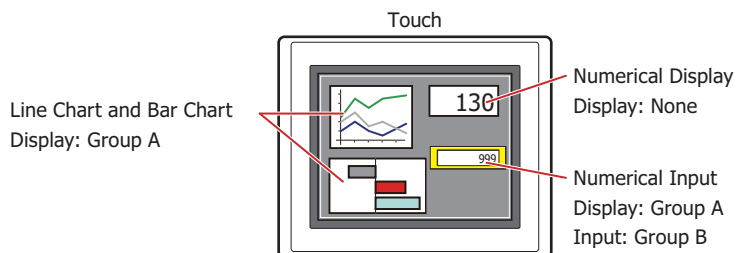

For User 1, who is not included in the specified security group, Group A parts are not displayed. If the Password Screen is now opened and a switch is made to User 2 of Group A, Group A parts are displayed.

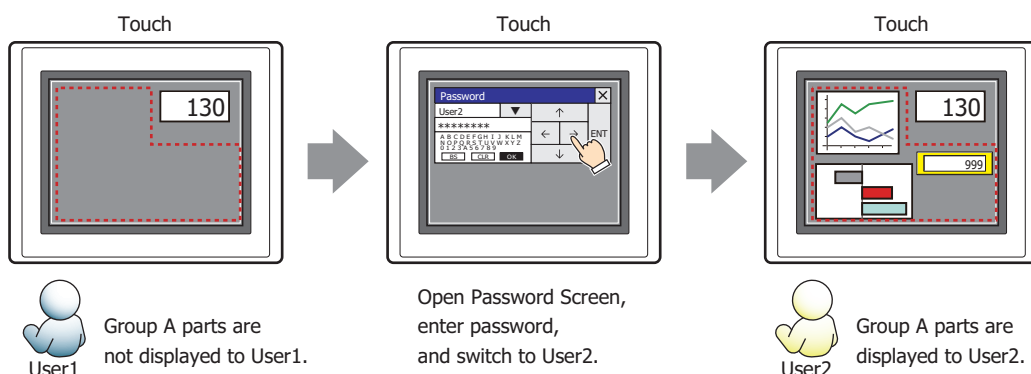

Since the display security group is Group A, User 2 (of Group A) can view the buttons. But since the input security group is Group B, User 2 cannot operate the buttons.

Suppose that the Password Screen is now opened and a switch is made to User 3, who is part of both Group A and Group B. Group A buttons can be displayed, and Group B buttons can be operated.

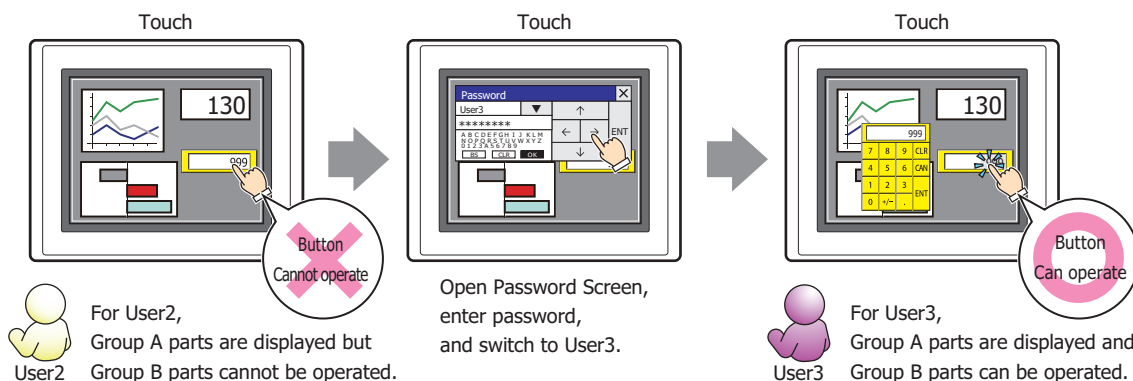

Input with Arithmetic Operation

To apply arithmetic operations to values entered using a keypad and writing the results, select this check box and input the arithmetic formula.

Example: To divide the value of device when entered by 60

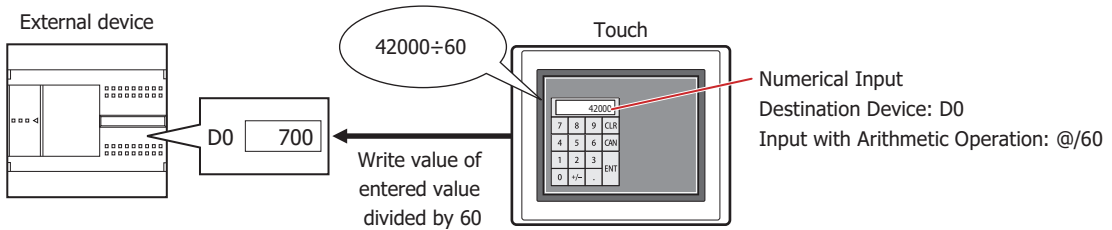

Display with Arithmetic Operation

To apply arithmetic operations to values of devices and writing the results, select this check box and input the arithmetic formula.

Example: To multiply the value of device when displayed by 60

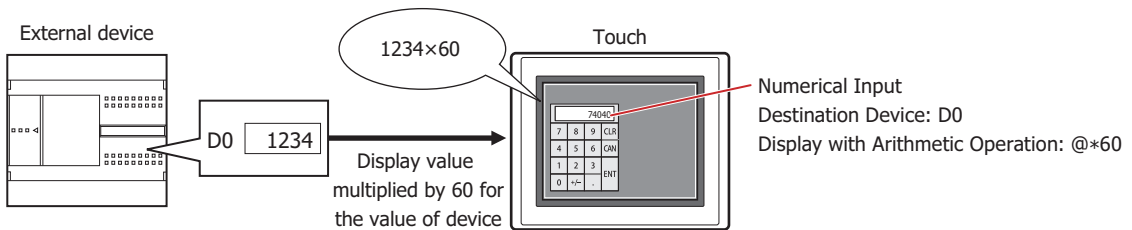

Arithmetic Formulas

Arithmetic formulas can be specified by freely combining multiple kinds of data and operators in the following format.



- There is no limit on the number of data items or number of operators. However, the maximum number is 120 characters.
- Round brackets can be used.

Data

Item	Description
@	The device on which the arithmetic operation is performed is specified in the arithmetic formula. Only 1 device can be set for an arithmetic operation. The device is as specified for Destination Device under the General tab.
Value	Sets the constant values for the arithmetic formula. The values that can be set depend on the data type selected using Data Format under the General tab. For details, refer to Chapter 2 "1.1 Available Data" on page 2-1.
Device	Specifies the bit device or word device for the arithmetic formula.

Operators

Specify the type of arithmetic operation to be performed on the data. The operator priority is the same as for scripts. For details, refer to Chapter 20 "6.4 About the Priority of the Operator" on page 20-53.

Item	Description		
Arithmetic operators	Sets the arithmetic operators.		
	+	Addition	Adds a and b .
	-	Subtraction	Subtracts b from a .
	*	Multiplication	Multiplies a and b .
	/	Division	Divides a by b .
%	Modulo	Calculates remainder after dividing a by b .	

Item	Description		
Bit operator	Sets the bit operator.		
	&	Logical AND	Calculates the logical product (AND) of each bit of <input type="text" value="a"/> and <input type="text" value="b"/> .
		Logical OR	Calculates the logical sum (OR) of each bit of <input type="text" value="a"/> and <input type="text" value="b"/> .
	^	Logical XOR (exclusive OR)	Calculates the exclusive logical sum (XOR) of each bit of <input type="text" value="a"/> and <input type="text" value="b"/> .
	<<	Left shift	Shifts each bit of <input type="text" value="a"/> to left by <input type="text" value="b"/> bit(s).
	>>	Right shift	Shifts each bit of <input type="text" value="a"/> to right by <input type="text" value="b"/> bit(s).

Examples of Arithmetic Formula Input

Input Examples	Description
@ + 1	To perform the arithmetic operation and input the result, add 1 to the value entered using the Keypad and write the result to the device.
	To perform the arithmetic operation and display the result, add 1 to the value of device and display the result.
[LDR 0] + @ + 100	To perform the arithmetic operation and input the result, add the value of LDR0 to the value entered using the Keypad and add 100, and write the result to the device.
	To perform the arithmetic operation and display the result, add the value of LDR0 to the value of device and add 100, then display the result.
@ & 3	To perform the arithmetic operation and input the result, write the logical AND operation of the value entered using the Keypad and 3 to the device.
	To perform the arithmetic operation and display the result, a logical AND operation of the value of device and 3 is displayed.

■ No Touch Sound

This function is to disable touch sounds only for specified parts when the Touch makes touch sounds. Select this check box to display disable touch sounds for this part.



To enable touch sounds on the Touch, select the **Enable Touch Sound** check box on the **System** tab in the Project Settings dialog box.

● Comment Tab

The **Comment** tab is used to specify the parts arranged on the editing screen, and the popup text displayed when the mouse pointer is placed close to **No.**, **Name**, or **Type** in the object list.



When there are multiple parts of the same shape on the screen, this feature makes it possible to distinguish between the parts without displaying the Properties dialog box for each part, by just mousing over the part.

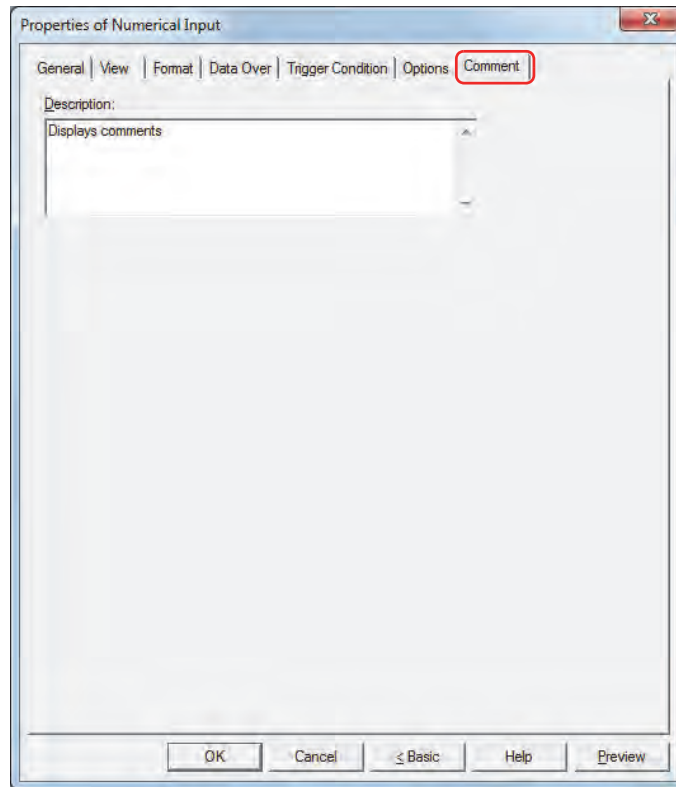

■ Description

Enter a comment about parts. The maximum number is 80 characters.

Example: When mousing over the Numerical Input on the editing screen



1.4 How to Enter Values

Use the keypad or key buttons to write a value to a device with the Numerical Input. The input methods are as follows.

■ Pressing the Numerical Input and Entering Values from the Standard Keypad

Arrange a Numerical Input on the screen and in its properties dialog box, on the **General** tab, under **Keypad**, select **Standard** for **Type**.

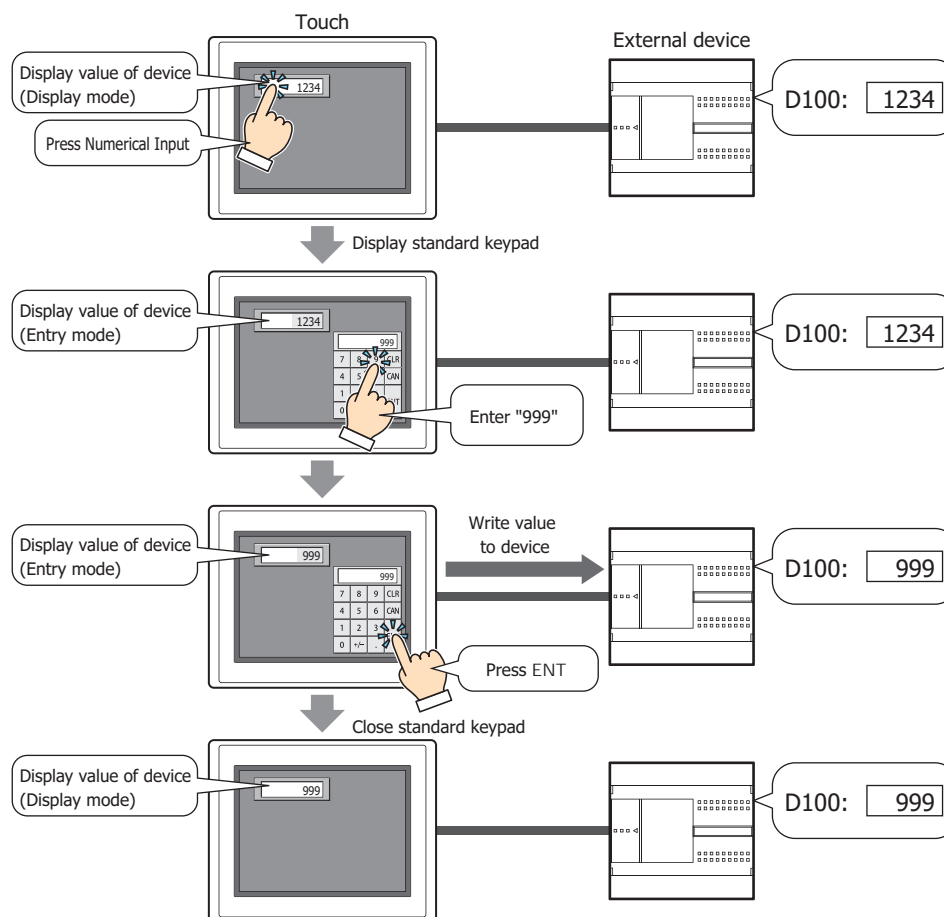

When the following operations are performed, entry mode is canceled and the current value of device is displayed in the Numerical Input. To enter a value, press the Numerical Input again to set it to entry mode.

- **CAN** is pressed.
- When the **Focus is moved by ENT button** check box on the **General** tab is cleared, a value was written to the device by pressing **ENT**.

■ Without Pressing the Numerical Input, Directly Entering Values from a Keypad on the Same Screen

Arrange a Numerical Input and a keypad on the same screen. In the properties dialog box for the Numerical Input, on the **General** tab, under **Keypad**, select **Current Screen** for **Type** and select the **Always Entry Mode** check box.

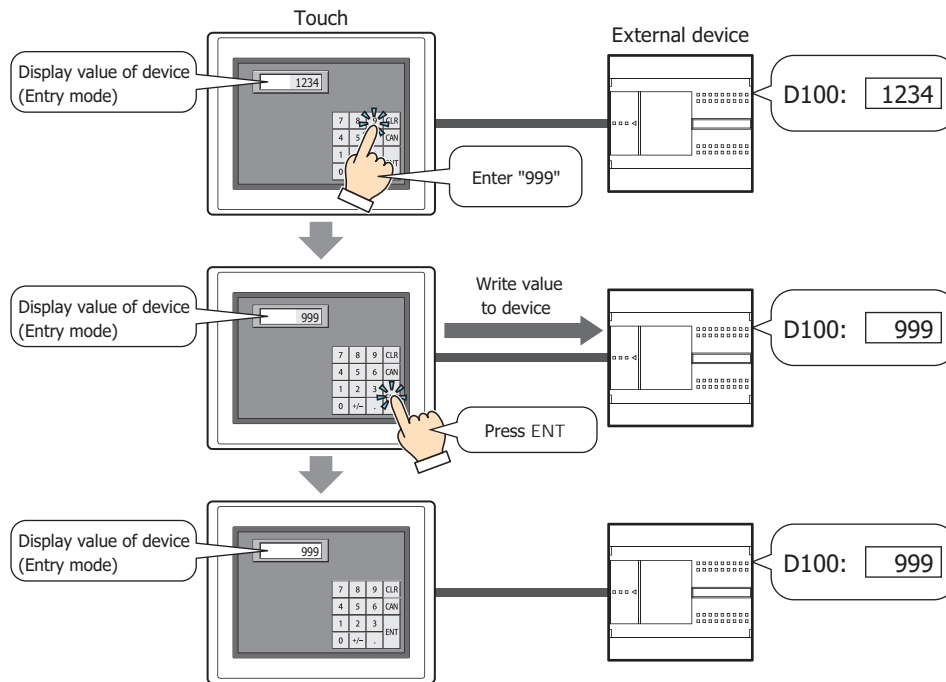

1.5 Advanced Usage

● Using the System Area

- When finished entering a value by pressing **ENT**, 1 is written to the System Area 2 Numerical Input setting complete bit (address+3, bit 0).



If the System Area 2 Numerical Input setting complete bit (address+3, bit 0) is set to another function's execution condition, that function can be executed when **ENT** is pressed.

Example: To simultaneously close a Popup Screen when **ENT** is pressed

In the Properties of Goto Screen Command dialog box, on the **General** tab, select **Close Popup Screen** for **Action Mode**. On the **Trigger Condition** tab, select **Rising-edge** for **Trigger Type**, and configure **Device** as the System Area 2 Numerical Input setting complete bit (address+3, bit 0).

- When **CAN** is pressed, entry mode is canceled and 1 is written to the System Area 2 Numerical Input setting cancel bit (address+3, bit 1). However, if the keypad is closed by pressing **✕** (close) on the Popup Screen's title bar or another Numerical Input is pressed before finished entering the value by pressing **ENT**, entry mode is canceled and 1 is not written to the System Area 2 Numerical Input setting cancel bit (address+3, bit 1).
- To clear the System Area 2 Numerical Input setting complete bit or the Numerical Input setting cancel bit, write 1 to System Area 1 Numerical Input setting clear bit (address+1, bit 10). To automatically clear these bits when the Numerical Input keypad is pressed in entry mode, select the **Clear Keypad bit in System Area automatically** check box on the **System** tab in the Project Settings dialog box.

2 Character Input

2.1 How the Character Input is Used

The Character Input features a display mode that displays the character codes in current values of devices as text and an entry mode that enters text using the keypad or key buttons and writes the character codes for the entered text to devices. When the part is displayed on the screen, the Character Input is in display mode. To enter text by pressing the keypad or key buttons, touch the Character Input to switch it to entry mode.

The Character Input can perform the following functions.

- Write the character codes for text entered with the keypad or key buttons to devices

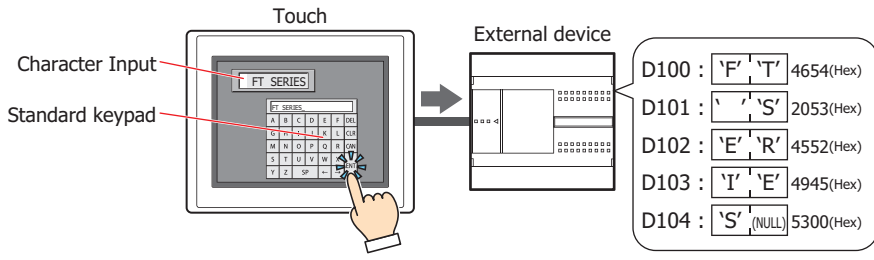

- Display the character codes in current values of devices as text

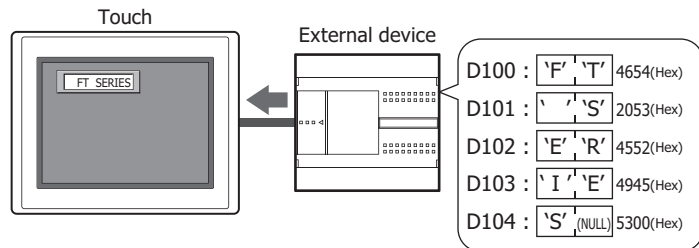

- Display entered text as * (asterisk)

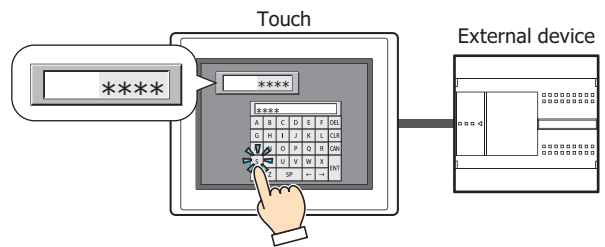

2.2 Character Input Configuration Procedure

This section describes the configuration procedure for Character Inputs.

- 1 On the **Home** tab, in the **Parts** group, click **Data Displays**, and then click **Character Input**.

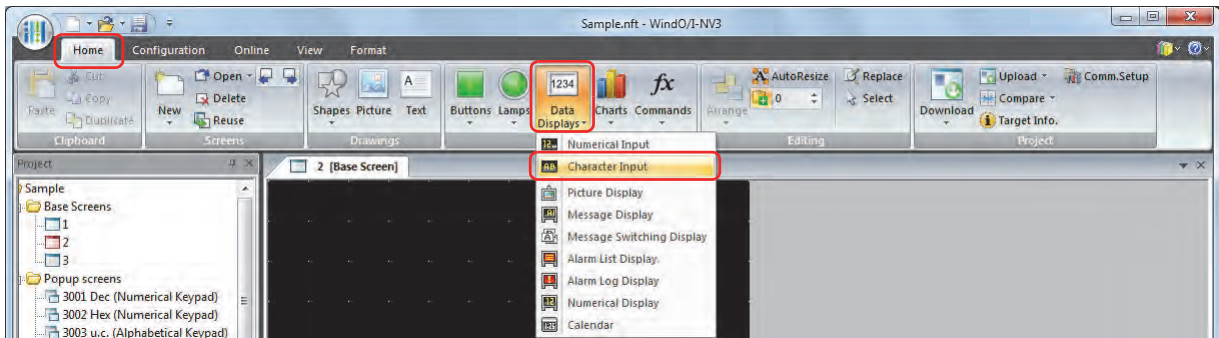

- 2 Click a point on the edit screen where you want to place the Character Input.
- 3 Double-click the dropped Character Input and a Properties dialog box will be displayed.
- 4 Change the settings on each tab as necessary.

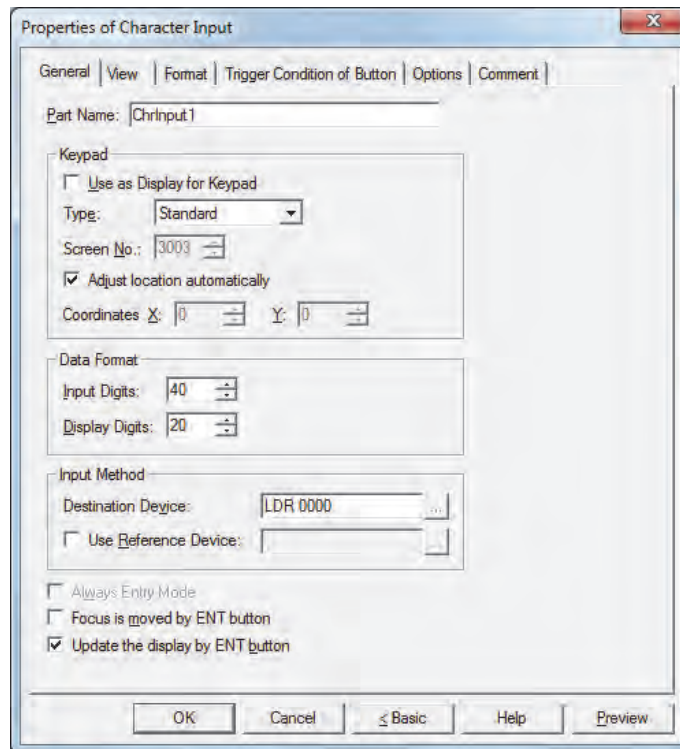

The **Trigger Condition** tab and **Options** tab only appear in Advanced mode. To switch to Advanced mode, click **Advanced**.

2.3 Properties of Character Input Dialog Box

This section describes items and buttons on the properties dialog box.

● General Tab

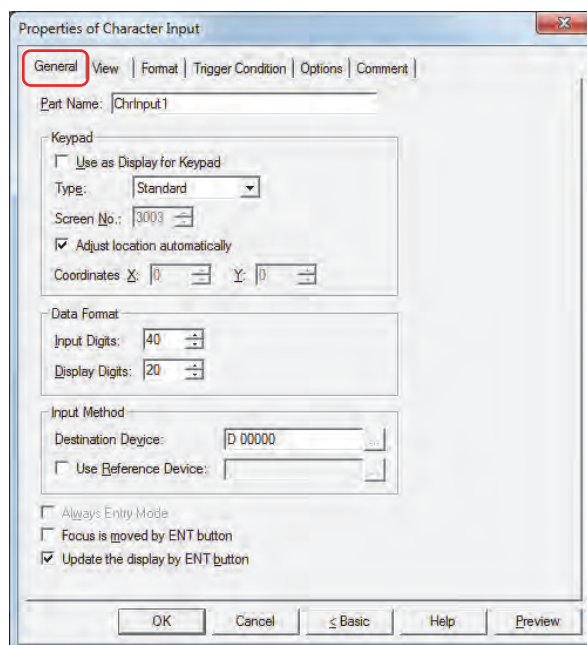

■ Part Name

Enter a name for the part. The maximum number is 20 characters.

■ Keypad

Configures the keypad for entering text in the Character Input.

- Use as Display for Keypad^{*1}: Select this check box to only use the Character Input as a part to display the text entered with the keypad.
- Type: According to the location where the keypad is configured, selects the type from the following.
- Standard: Uses the standard keypad. The standard keypad is the keypad configured as the Popup Screen for the standard keypad (screen number 3000 to 3015).
 - Popup: Uses a keypad configured as a Popup Screen.
 - Current Screen: Uses the keypad configured on the same screen as the Character Input.
- Screen No.: Specifies the screen number of the Popup Screen configured as the keypad (1 to 3015). This option can only be configured if **Popup** is selected for **Type**.
- Adjust location automatically: Select this check box to display the Popup Screen configured as the keypad in a location where it will not overlap the Character Input. This option can only be configured if **Standard** or **Popup** is selected for **Type**.
- Coordinates X, Y: Specifies the display location of the Popup Screen configured as the keypad. With the upper-left corner of the screen as the origin, the X and Y coordinates are the upper-left corner of the Popup Screen. This option can only be configured when **Popup** is selected for **Type** and the **Adjust location automatically** check box is cleared. Specify the coordinates in 1 dot units.
- X: 0 to (Base Screen horizontal size - 1)
 - Y: 0 to (Base Screen vertical size - 1)

*1 Advanced mode only

Data Format

Specifies the digits to display.

Input Digits: Specifies the number of digits that can be entered with the Character Input (1 to 127).

Display Digits: Specifies the number of digits that can be displayed in the Character Input display (1 to 100).

Input Method

These options configure the destination for the character codes for the entered text.

Destination Device: Specifies the destination word device for the character codes for the entered text.

Click to display the Device Address Settings dialog box. For the device address configuration procedure, refer to Chapter 2 “5.1 Device Address Settings” on page 2-61.

Use Reference Device *1: Select this check box and specify a device to change the destination word device by the value of this device.

Click to display the Device Address Settings dialog box. For the device address configuration procedure, refer to Chapter 2 “5.1 Device Address Settings” on page 2-61. For details on indirect writing, refer to Chapter 2 “Indirect Read and Indirect Write Settings” on page 2-4.

Always Entry Mode*1

Select this check box to enter text by directly pressing the keypad and key buttons without touching the Character Input displayed on the screen.

This option can only be configured if **Current Screen** is selected for **Type**.

Example: When the **Always Entry mode** check box is selected

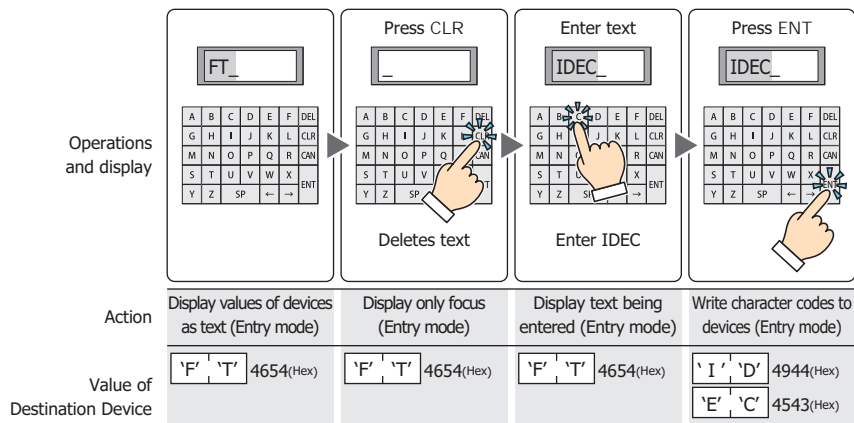

Only one Numerical Input or one Character Input set to **Always Entry Mode** can be configured on a single screen.

Example: When the **Always Entry Mode** check box is cleared

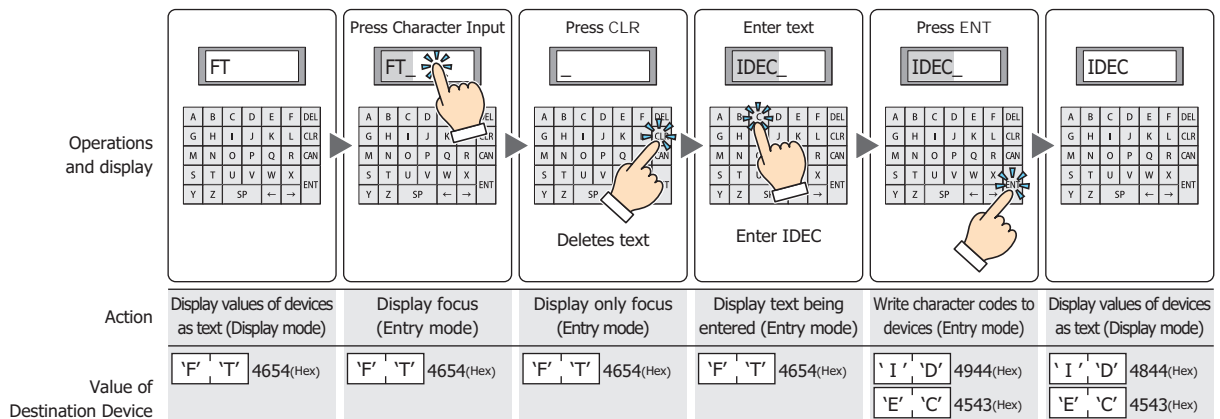

*1 Advanced mode only

■ **Focus is moved by ENT button*1**

When multiple Character Inputs are configured on the screen, select this check box to continue entering text on each of the Character Inputs.

Each time **ENT** is pressed, the focus moves between the Character Inputs according to **Focus Order**. On the **View** tab, in the **Screens** group, click **Focus Order**, and then click the Character Inputs in the order to move the focus.

Example: When Character Input A and B are configured and the **Focus is moved by ENT button** check box for Character Input A is selected and the **Focus is moved by ENT button** check box for Character Input B is cleared

Operations and display										
	Character Input A Action	Display values of devices as text (Display mode)	Display focus (Entry mode)	Display text being entered (Entry mode)	Write character codes to devices (Entry mode)	Display values of devices as text (Display mode)	Display focus (Entry mode)	Display text being entered (Entry mode)	Write character codes to devices (Entry mode)	Display values of devices as text (Display mode)
Character Input B Action	Display values of devices as text (Display mode)				Display focus (Entry mode)	Display text being entered (Entry mode)	Write character codes to devices (Entry mode)	Display values of devices as text (Display mode)		
Character Input A Value of Destination Device	'F','T' 4654(Hex)	'F','T' 4654(Hex)	'F','T' 4654(Hex)	'F','T' 4654(Hex) 'S',' ' 2053(Hex) 'E','R' 4552(Hex) 'I','E' 4945(Hex) 'S', (NULL) 5300(Hex)	'F','T' 4654(Hex) 'S',' ' 2053(Hex) 'E','R' 4552(Hex) 'I','E' 4945(Hex) 'S', (NULL) 5300(Hex)	'F','T' 4654(Hex) 'S',' ' 2053(Hex) 'E','R' 4552(Hex) 'I','E' 4945(Hex) 'S', (NULL) 5300(Hex)	'F','T' 4654(Hex) 'S',' ' 2053(Hex) 'E','R' 4552(Hex) 'I','E' 4945(Hex) 'S', (NULL) 5300(Hex)	'F','T' 4654(Hex) 'S',' ' 2053(Hex) 'E','R' 4552(Hex) 'I','E' 4945(Hex) 'S', (NULL) 5300(Hex)	'F','T' 4654(Hex) 'S',' ' 2053(Hex) 'E','R' 4552(Hex) 'I','E' 4945(Hex) 'S', (NULL) 5300(Hex)	'F','T' 4654(Hex) 'S',' ' 2053(Hex) 'E','R' 4552(Hex) 'I','E' 4945(Hex) 'S', (NULL) 5300(Hex)
Character Input B Value of Destination Device	'M','I' 4D49(Hex) 'C','R' 4352(Hex) 'O', (NULL) 4100(Hex)	'M','I' 4D49(Hex) 'C','R' 4352(Hex) 'O', (NULL) 4100(Hex)	'M','I' 4D49(Hex) 'C','R' 4352(Hex) 'O', (NULL) 4100(Hex)	'M','I' 4D49(Hex) 'C','R' 4352(Hex) 'O', (NULL) 4100(Hex)	'M','I' 4D49(Hex) 'C','R' 4352(Hex) 'O', (NULL) 4100(Hex)	'M','I' 4D49(Hex) 'C','R' 4352(Hex) 'O', (NULL) 4100(Hex)	'M','I' 4D49(Hex) 'C','R' 4352(Hex) 'O', (NULL) 4100(Hex)	'M','I' 4D49(Hex) 'C','R' 4352(Hex) 'O', (NULL) 4100(Hex)	'M','I' 4D49(Hex) 'C','R' 4352(Hex) 'O', (NULL) 4100(Hex)	'M','I' 4D49(Hex) 'C','R' 4352(Hex) 'O', (NULL) 4100(Hex)

■ **Update the display by ENT button*1**

Select this check box to display the current text unchanged and update the display when text is entered and **ENT** is pressed.

When this check box is cleared, the display updates with each press of a character button to display the character being entered.

Operations and display					
	Action	Display values of devices as text (Display mode)	Display focus (Entry mode)	Display text being entered (Entry mode)	Write character codes to devices (Entry mode)
Value of Destination Device	'F','T' 4654(Hex)	'F','T' 4654(Hex)	'F','T' 4654(Hex)	'F','T' 4654(Hex) 'S',' ' 2053(Hex) 'E','R' 4552(Hex) 'I','E' 4943(Hex) 'S', (NULL) 5300(Hex)	'F','T' 4654(Hex) 'S',' ' 2053(Hex) 'E','R' 4552(Hex) 'I','E' 4943(Hex) 'S', (NULL) 5300(Hex)
Character Input display	FT	FT	FT	FT SERIES	FT SERIES
Keypad display	Hide	FT	FT SERIES	FT SERIES	Hide

*1 Advanced mode only

● View Tab

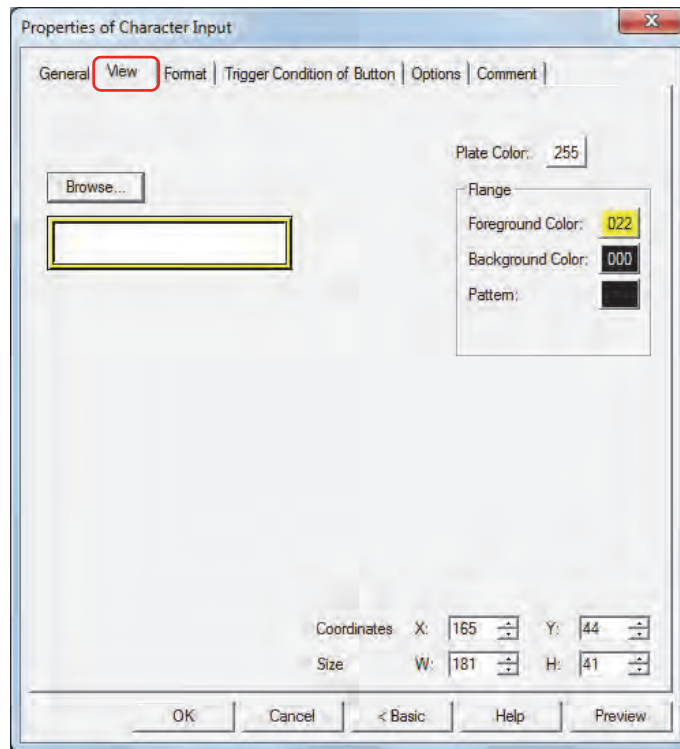

■ Browse

Select the type of graphic to represent the part from the list of graphics. Click this button to display the View Browser.

■ Plate Color

Selects the plate color of the standard graphic (color: 256 colors, monochrome: 8 shades).

Click the **Color** button to display the Color Palette. Select a color from the Color Palette.



■ Flange

Foreground Color, Background Color:

Selects the foreground and background colors of the flange of the standard graphic (color: 256 colors, monochrome: 8 shades).

Click the **Color** button to display the Color Palette. Select a color from the Color Palette.

Pattern:

Selects a pattern for the flange of the standard graphic.

Click the **Pattern** button to display the Pattern Palette. Select a pattern from the Pattern Palette.

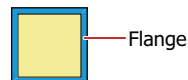

■ Coordinates

- X, Y: Sets the display position of parts using coordinates.
 The X and Y coordinates of parts is defined relative to an origin at the top-left corner of the screen.
- X: 0 to (Base Screen horizontal size - 1)
- Y: 0 to (Base Screen vertical size - 1)

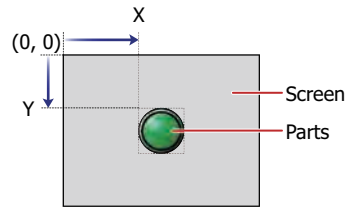

■ Size

- W, H: Sets width and height to define the size of parts.
- W: 20 to (Base Screen horizontal size)
- H: 20 to (Base Screen vertical size)

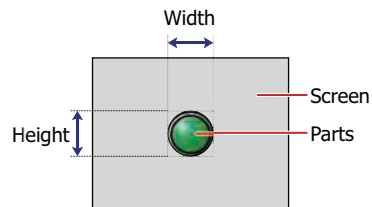

● Format Tab

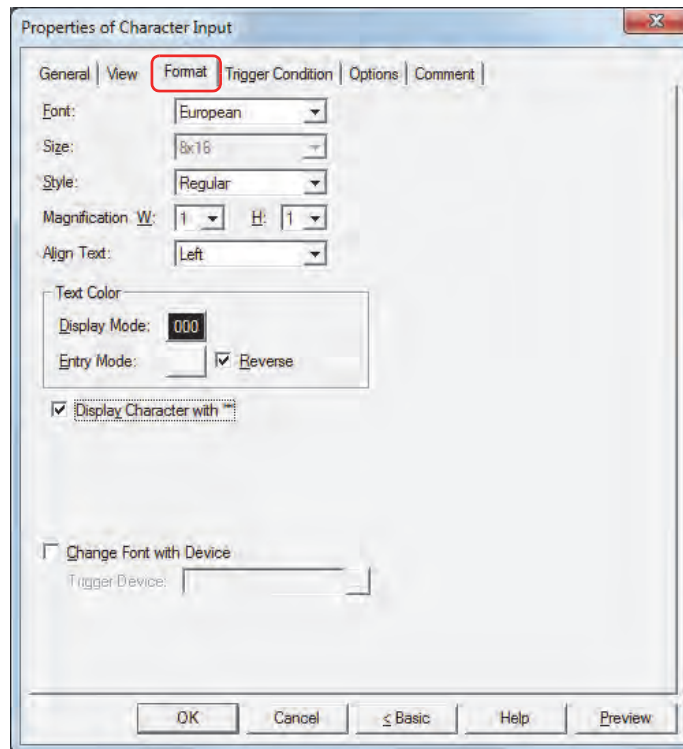

■ Font

Selects the font for displaying text from the following.

Japanese, European, Central European, Baltic, Cyrillic

The characters that can be displayed depend on the font. For details, refer to Chapter 2 “1.2 Available Text” on page 2-5.

■ Size

Selects the text size as **8x16** or **16x16**.

■ Style

Selects **Regular** or **Bold** for text style.

■ Magnification

W, H: Selects text magnification (0.5, 1 to 8).

■ Align Text

Selects the text alignment in the horizontal direction from the following.

Left, Center, Right

For details, refer to Appendix “5 Text Alignment” on page A-5.

■ Text Color

Selects the color of displayed text (color: 256 colors, monochrome: 8 shades).

Click the **Color** button to display the Color Palette. Select a color from the Color Palette.

This option can configure the text color in display mode and in entry mode. However, for **Entry Mode** text color can be set only when the **Reverse** check box is cleared.

■ Reverse

Select this check box to reverse the text color and plate color during display mode when in entry mode.

■ **Display Character with "*" *1**

Select this check box to display the entered characters as * (asterisks).

If this check box is selected, nothing is displayed until a value is entered from the key buttons or keypad when the Character Input is in entry mode. If **ENT** is pressed with nothing displayed, 0 is written to the destination device.

■ **Change Font with Device *1**

Select this check box to change the font to display the text with a value of device.

The keypad (Popup Screen) can also be changed when **Standard** or **Popup** is selected for **Type** under **Keypad** on the **General** tab.

Trigger Device: Specifies the word device (2 words) to use as the condition to change the font.

Click to display the Device Address Settings dialog box. For the device address configuration procedure, refer to Chapter 2 "5.1 Device Address Settings" on page 2-61.

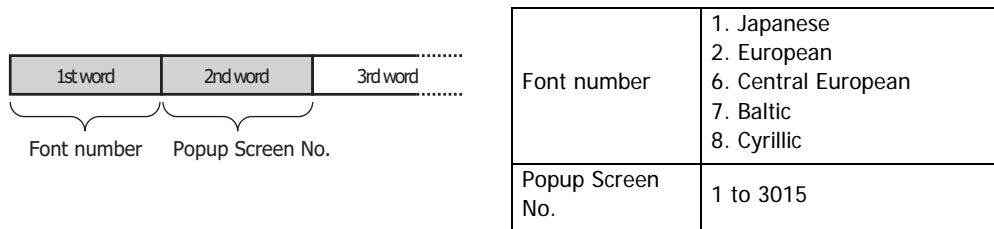

Example: With **Trigger Device** set to D100, to enter Central European text from Popup Screen 100 using a Character Input for entering European text from the standard keypad (Popup Screen 3003)
Write 6 to D100 and 100 to D101.

*1 Advanced mode only

● **Trigger Condition Tab**

The **Trigger Condition** tab is displayed in Advanced mode.

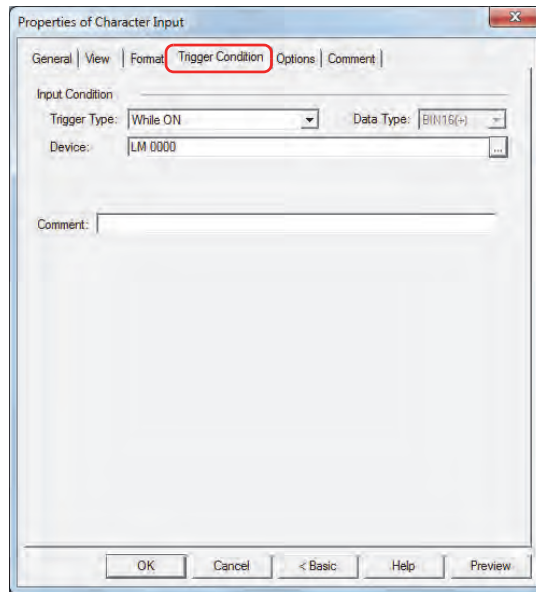

■ **Input Condition**

The Character Input is enabled and operational while the condition is satisfied. The Character Input is disabled and not operational while the condition is not satisfied.

Example: When **Trigger Type** is **While ON**, **Device** is LM0

While LM0 is 0, the condition is not satisfied and the Character Input is not operational.

While LM0 is 1, the condition is satisfied and the Character Input is operational.

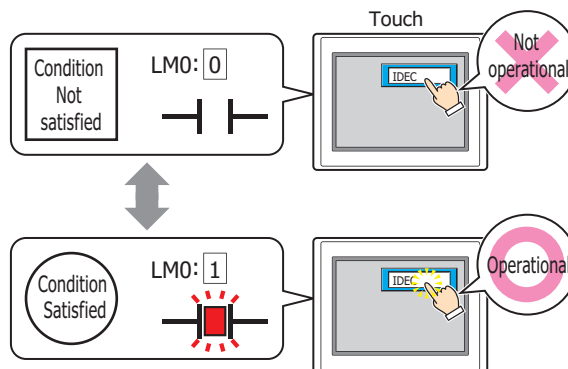

Trigger Type: Selects the condition to enable the Character Input from the following.

Always Enabled: The Character Input is always enabled.

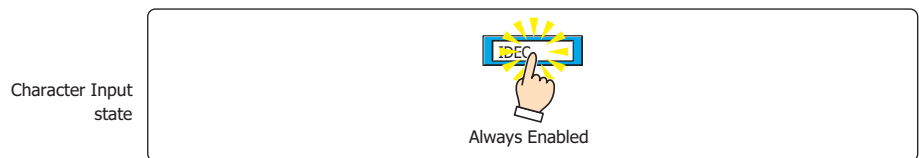

While ON: Enables the Character Input when the value of device is 1.

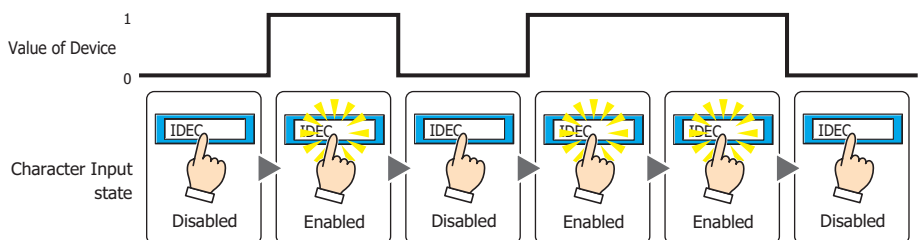

While OFF: Enables the Character Input when the value of device is 0.

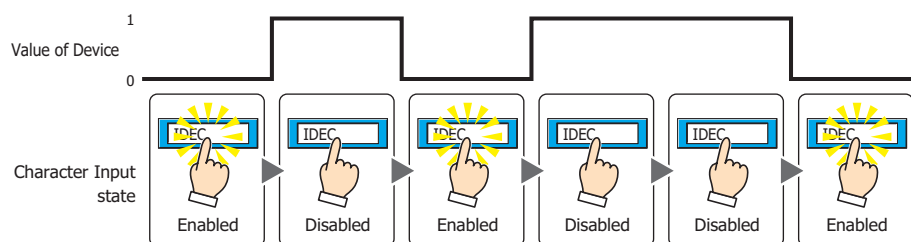

While satisfying the condition:

Enables the Character Input when the condition is satisfied.

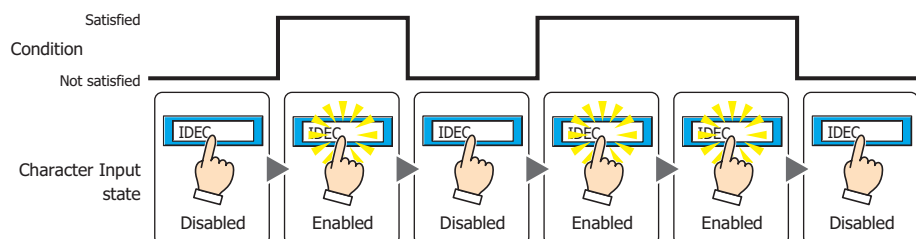

- Data Type:** Selects the type of data handled by the conditional expression for the input condition. This option can only be configured if **While satisfying the condition** is selected for **Trigger Type**. For details, refer to Chapter 2 “1.1 Available Data” on page 2-1.
- Device:** Specifies the bit device or bit of the word device to serve as the input condition. This option can only be configured when **While ON** or **While OFF** is selected for **Trigger Type**. Click to display the Device Address Settings dialog box. For the device address configuration procedure, refer to Chapter 2 “5.1 Device Address Settings” on page 2-61.
- Condition:** Specifies the conditional expression for the input condition. This option can only be configured when **While satisfying the condition** is selected for **Trigger Type**. Click to display the Trigger Condition Settings dialog box. For the conditional expression configuration procedure, refer to Chapter 2 “5.2 Setting Conditional Expressions” on page 2-63.
- Comment:** Enter a comment for the input condition. The maximum number is 80 characters.

● Options Tab

The **Options** tab is displayed in Advanced mode.

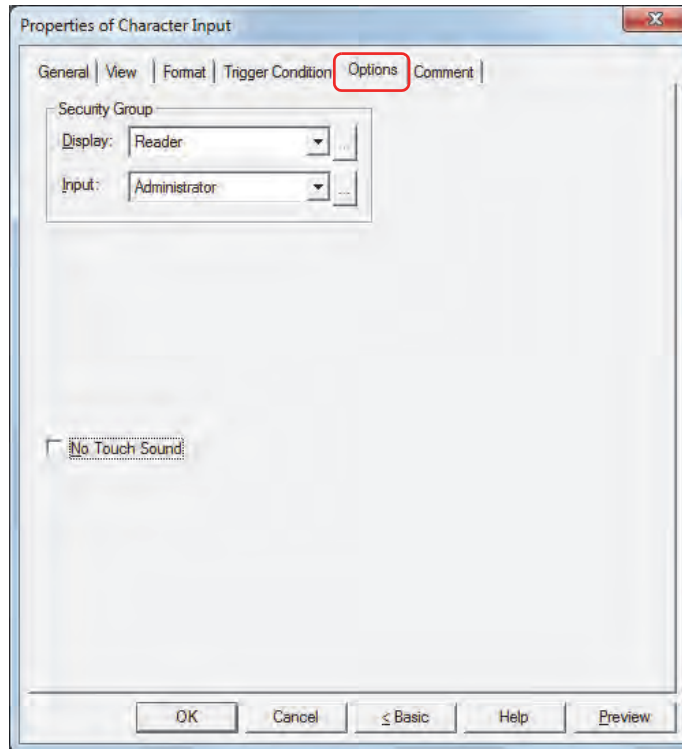

■ Security Groups

Security groups are a security function for restricting the display and operation of parts.

Display: Selects the security group for which display of parts is restricted. (Default: None)

None: No security function is used.

Administrator, Operator, Reader: Three security groups are set up by default.

Click  to display the Security Group Settings dialog box. If you create a security group on the Security Group Settings dialog box, you can select that created group. For details, refer to Chapter 21 “2.2 Adding and Editing Security Groups” on page 21-15.

Input: Selects the security group for which operation of parts is restricted. (Default: None)

None: No security function is used.



Administrator, Operator, Reader: Three security groups are set up by default.

Click  to display the Security Group Settings dialog box. If you create a security group on the Security Group Settings dialog box, you can select that created group. For details, refer to Chapter 21 “2.2 Adding and Editing Security Groups” on page 21-15.



For details about security functions, refer to Chapter 21 “User Accounts and the Security Function” on page 21-1.

Example: If the user and security group for a part are set as follows:

User Name	 User1	 User2	 User3
Security Group	None	Group A	Group A, Group B

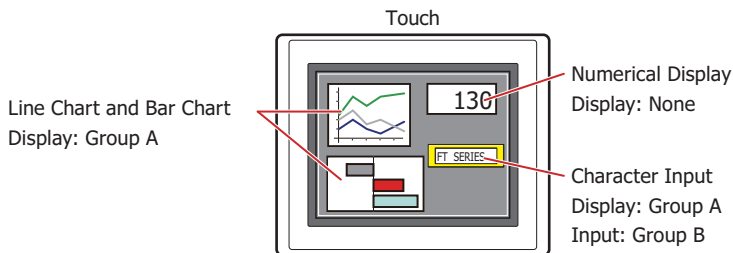

For User 1, who is not included in the specified security group, Group A parts are not displayed. If the Password Screen is now opened and a switch is made to User 2 of Group A, Group A parts are displayed.

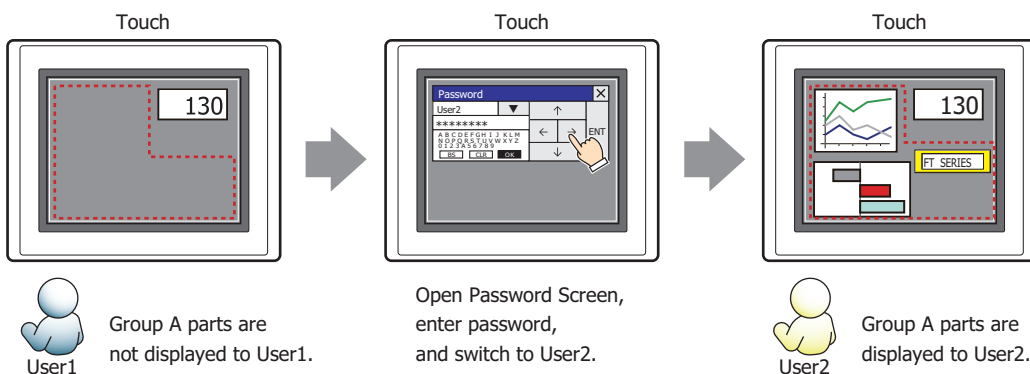

Since the display security group is Group A, User 2 (of Group A) can view the buttons. But since the input security group is Group B, User 2 cannot operate the buttons.

Suppose that the Password Screen is now opened and a switch is made to User 3, who is part of both Group A and Group B. Group A buttons can be displayed, and Group B buttons can be operated.

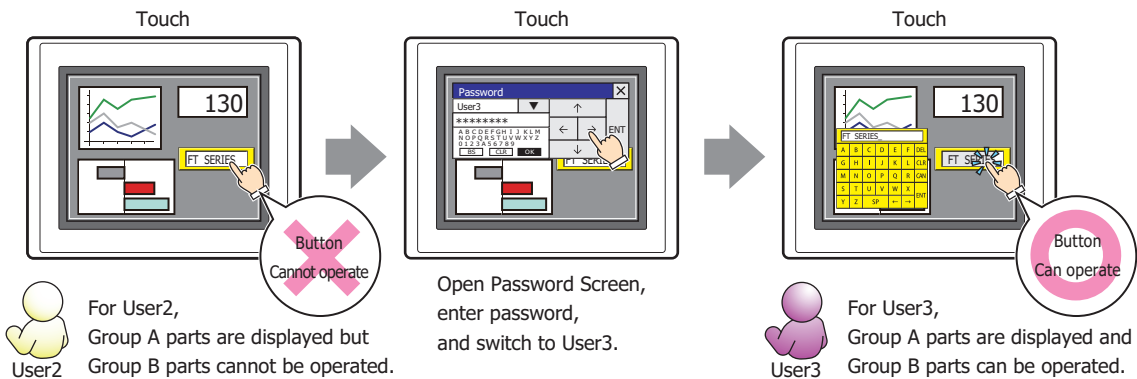

No Touch Sound

This function is to disable touch sounds only for specified parts when the Touch makes touch sounds. Select this check box to display disable touch sounds for this part.



To enable touch sounds on the Touch, select the **Enable Touch Sound** check box on the **System** tab in the Project Settings dialog box.

● Comment Tab

The **Comment** tab is used to specify the parts arranged on the editing screen, and the popup text displayed when the mouse pointer is placed close to **No.**, **Name**, or **Type** in the object list.



When there are multiple parts of the same shape on the screen, this feature makes it possible to distinguish between the parts without displaying the Properties dialog box for each part, by just mousing over the part.

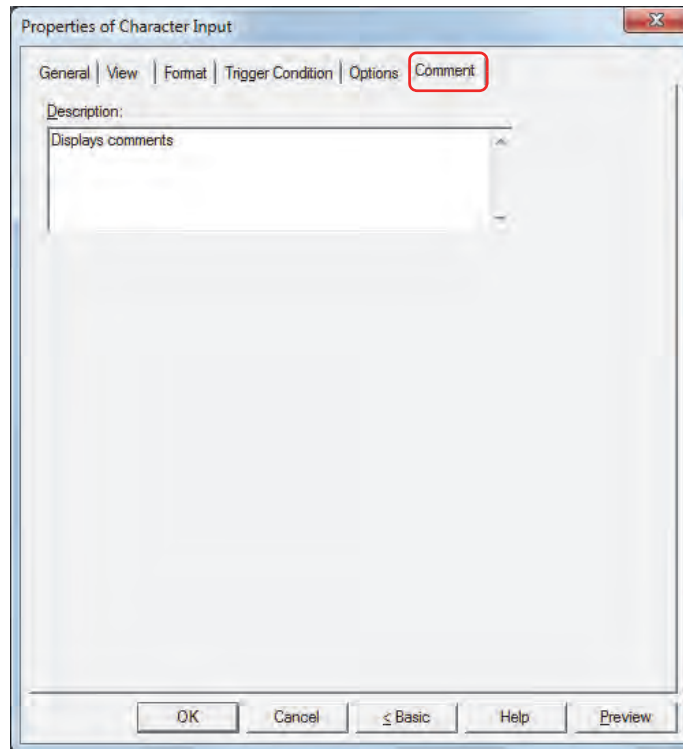

■ Description

Enter a comment about parts. The maximum number is 80 characters.

Example: When mousing over the Character Input on the editing screen



2.4 How to Enter Text

Use the keypad or key buttons to write character codes to devices with the Character Input. The input methods are as follows.

■ Pressing the Character Input and Entering Text from the Standard Keypad

Arrange a Character Input on the screen and in its properties dialog box, on the **General** tab, under **Keypad**, select **Standard** for **Type**.

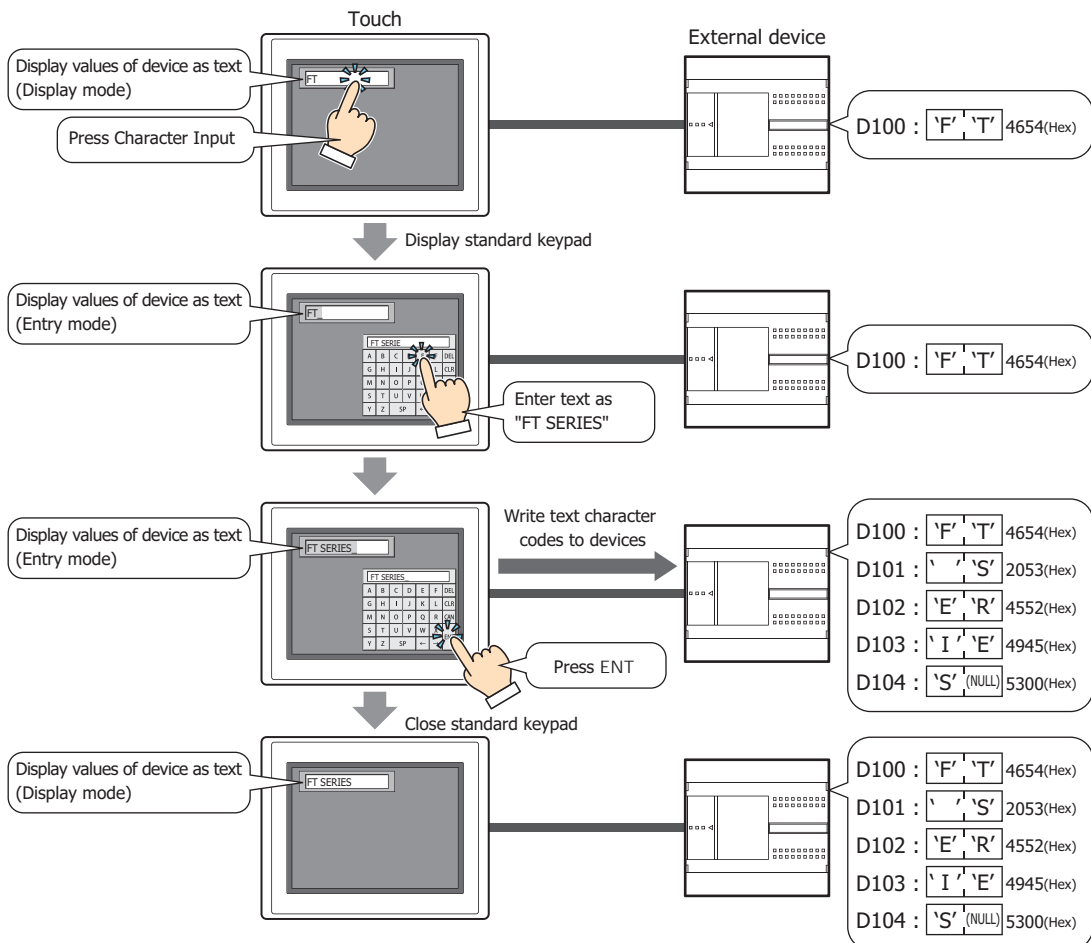

When the following operations are performed, entry mode is canceled and the current values of devices are displayed as character codes on the Character Input. To enter text, press the Character Input again to select it and set it to entry mode.

- **CAN** is pressed.
- When the **Focus is moved by ENT button** check box on the **General** tab is cleared, a value was written to the device by pressing **ENT**.

■ **Without Pressing the Character Input, Directly Entering Text from a Keypad on the Same Screen**

Arrange a Character Input and a keypad on the same screen. In the properties dialog box for the Character Input, on the **General** tab, under **Keypad**, select **Current Screen** for **Type** and select the **Always Entry Mode** check box.

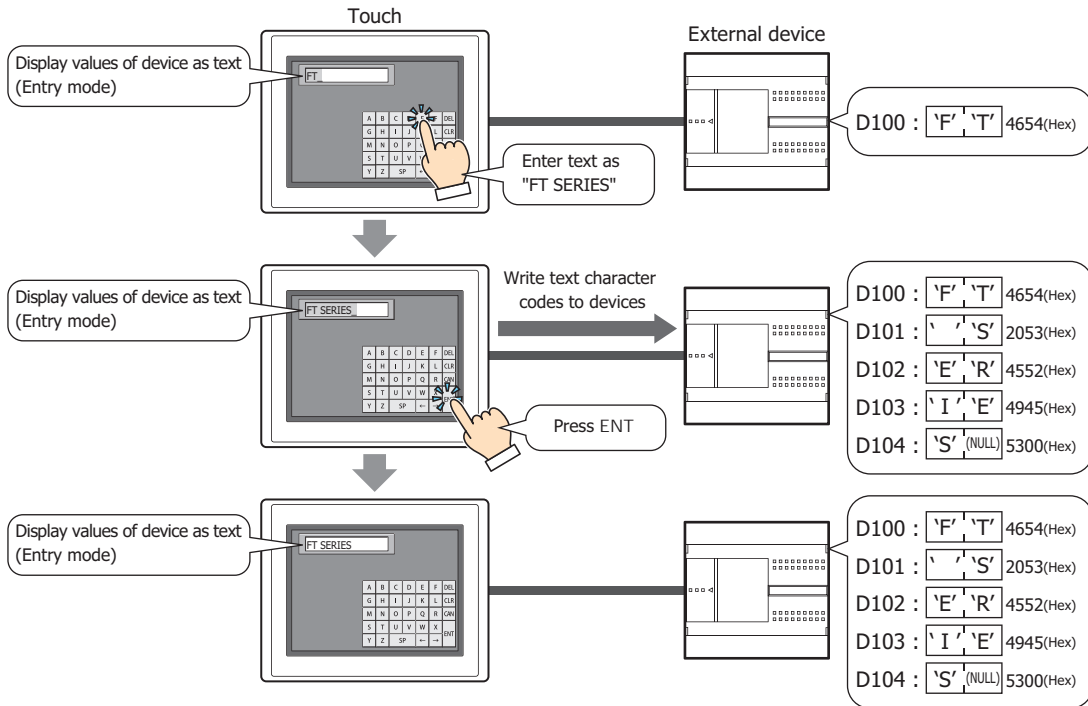

■ **Changing the Language and Entering Text**

Select the **Change Font with Device** check box on the **Format** tab in the properties dialog box.

It is convenient to use this setting together with the text group settings.

The font and Popup Screen with this setting will change simultaneously with the text group change and text can be entered with the same font as the text group.

Select the **Use Dynamic Text** check box in the Text Group Settings dialog box and specify the same device in **Trigger Device** as the **Trigger Device** for this setting.

2.5 String Data Storage Method

The entered text is stored in the upper byte and lower byte according to the **Storage Method of String Data** setting. **Storage Method of String Data** is configured on the **System** tab in the Project Settings dialog box. For details, refer to Chapter 3 "3.1 System Tab" on page 3-19.

Example: When the destination device is LDR100 and the entered text is ABCDE

- When **from Upper byte** is selected for **Storage Method of String Data**

Device	Stored value	
	Upper byte	Lower byte
LDR100	'A' = 41 (Hex)	'B' = 42 (Hex)
LDR101	'C' = 43 (Hex)	'D' = 44 (Hex)
LDR102	'E' = 45 (Hex)	0

NULL terminating character

- When **from Lower byte** is selected for **Storage Method of String Data**

Device	Stored value	
	Upper byte	Lower byte
LDR100	'B' = 42 (Hex)	'A' = 41 (Hex)
LDR101	'D' = 44 (Hex)	'C' = 43 (Hex)
LDR102	0	'E' = 45 (Hex)

NULL terminating character



When handling strings, 0 is written to the device as the NULL terminating character and treated as the end of the string.

2.6 Advanced Usage

● Using the System Area

- When finished entering text by pressing **ENT**, 1 is written to the System Area 2 Character Input setting complete bit (address+3, bit 5).
- When **CAN** is pressed, entry mode is canceled and 1 is written to the System Area 2 Character Input setting cancel bit (address+3, bit 6). However, if the keypad is closed by pressing  (close) on the Popup Screen's title bar or another Character Input is pressed and selected before finished entering the text by pressing **ENT**, entry mode is canceled and 1 is not written to the System Area 2 Character Input setting cancel bit (address+3, bit 5).
- To clear the System Area 2 Character Input setting complete bit or the Character Input setting cancel bit, write 1 to System Area 1 Character Input setting clear bit (address+1, bit 11). To automatically clear these bits when the Character Input keypad is pressed in entry mode, select the **Clear Keypad bit in System Area automatically** check box on the **System** tab in the Project Settings dialog box.

3 Picture Display

3.1 How the Picture Display is Used

The Picture Display displays pictures. It can change, move, or scale the displayed picture according to values of devices.

- Switch and display pictures by values of devices

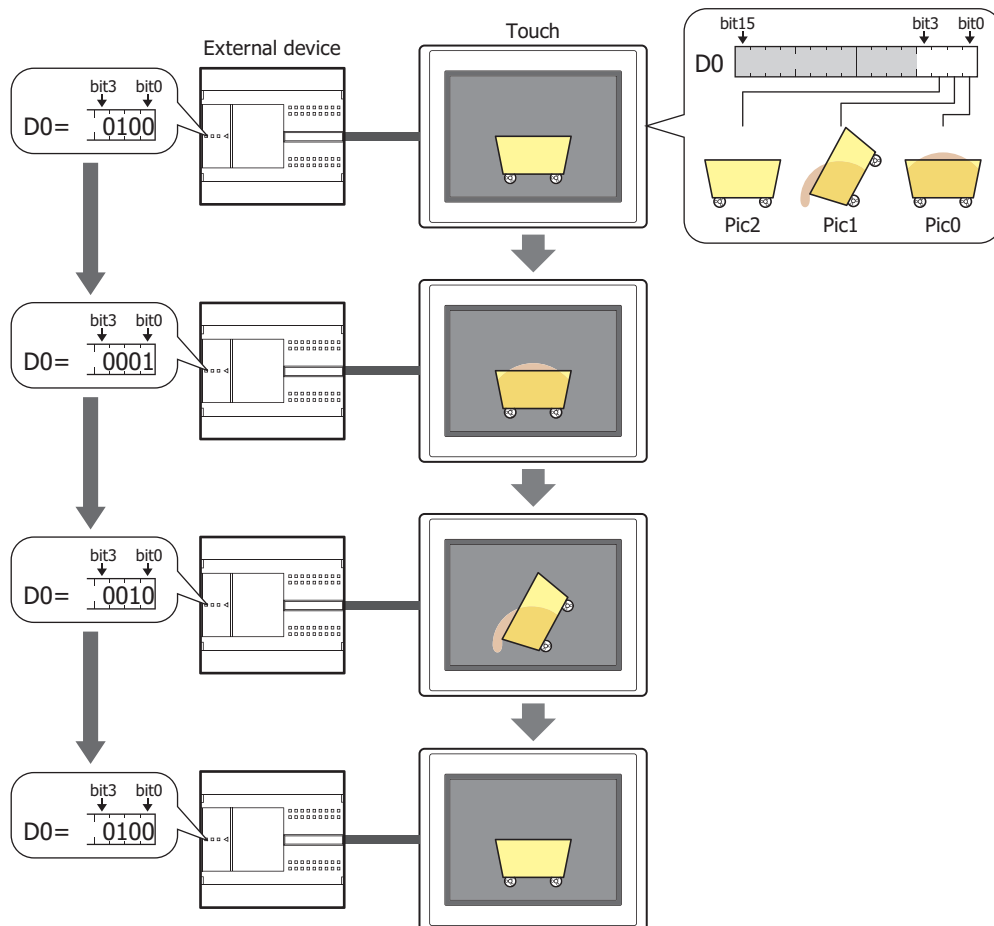

- Move the picture position by values of devices

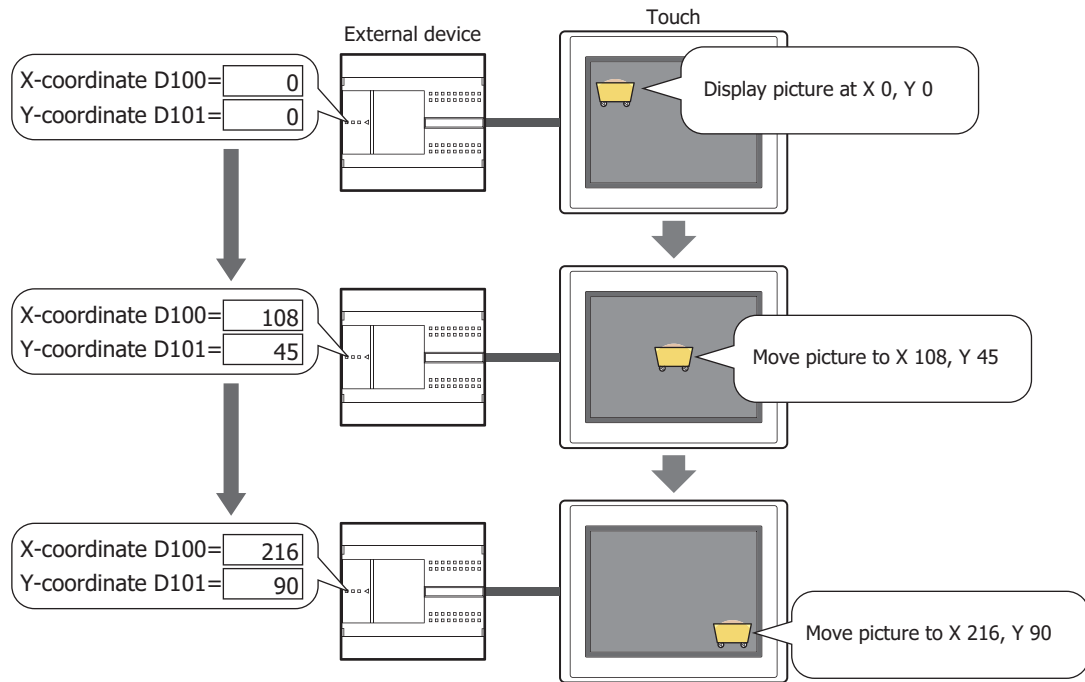

- Scale the size of the picture by values of devices and display it

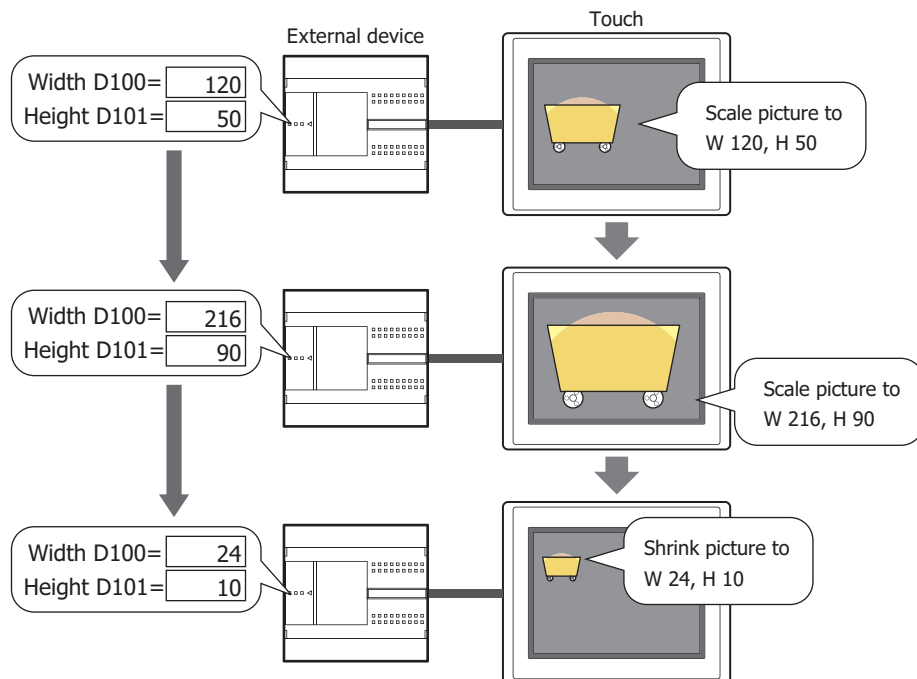

When the size of pictures to switch differs and the **Dynamic Size** check box is cleared, all the pictures are displayed with the same size as Pic0.

3.2 Picture Display Configuration Procedure

This section describes the configuration procedure for Picture Displays.

- 1 On the **Home** tab, in the **Parts** group, click **Data Displays**, and then click **Picture Display**.

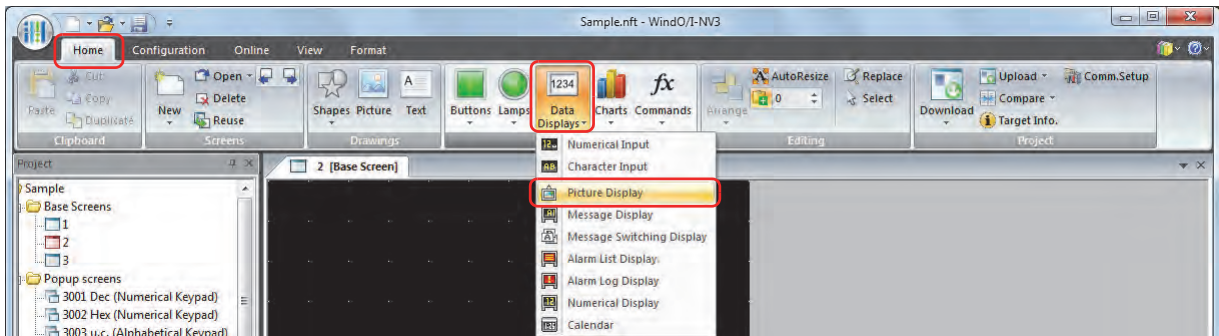

- 2 Click a point on the edit screen where you want to place the Picture Display.
- 3 Double-click the dropped Picture Display and a Properties dialog box will be displayed.
- 4 Change the settings on each tab as necessary.

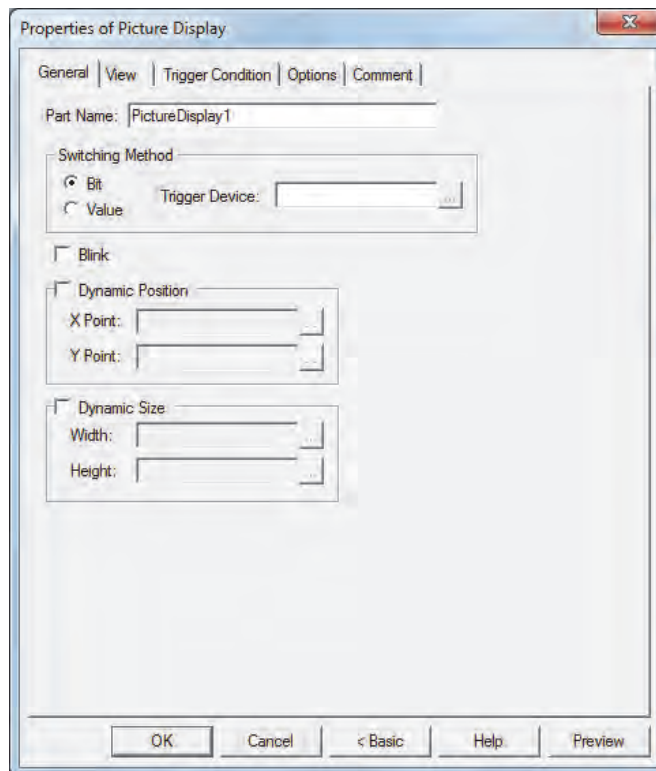

The **Trigger Condition** tab and **Options** tab only appear in **Advanced** mode. To switch to Advanced mode, click **Advanced**.

3.3 Properties of Picture Display Dialog Box

This section describes items and buttons on the properties dialog box.

● **General Tab**

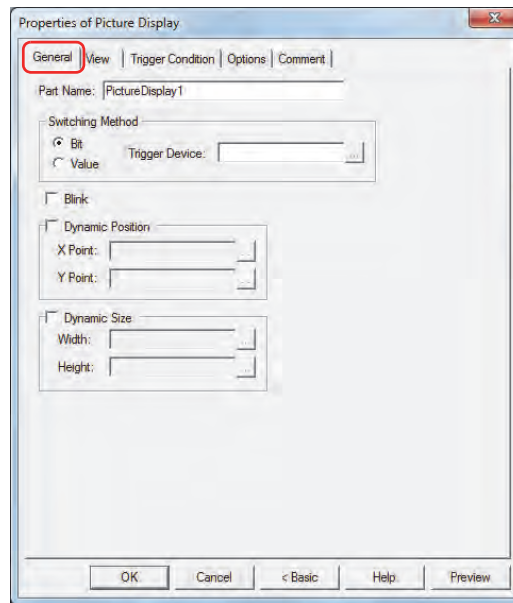

■ **Part Name**

Enter a name for the part. The maximum number is 20 characters.

■ **Switching Method**

Specifies the method for switching pictures to display from the following. Register pictures in **Picture List** on the **View** tab.

Bit: Switches the picture to display according to the status of bits in a device.

Example: When **Bit** is selected and the bits of trigger device D0 are allocated to the following pictures.

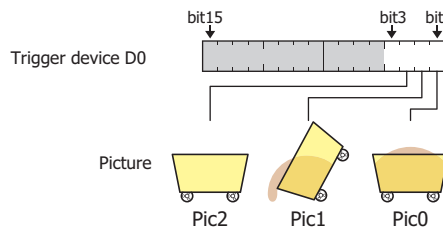

Switches the picture to display according to the status of the bits.

Trigger device D0 bit state	0001	0010	0100	1000	1110	1100
Picture to display						
Action	Display picture for bit 0	Display picture for bit 1	Display picture for bit 2	No picture	Display picture for bit 1	Display picture for bit 2

If multiple bits are 1, display the picture for the lowest order bit.

If all bits in the device are 0 or if a bit with no associated picture becomes 1, display nothing.

Value: Switches the picture to display according to the value of device.
 Example: When **Value** is selected and the values of **Trigger Device D0** are allocated to the following pictures.

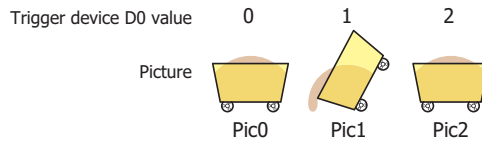

Switches the picture to display according to the value of device.

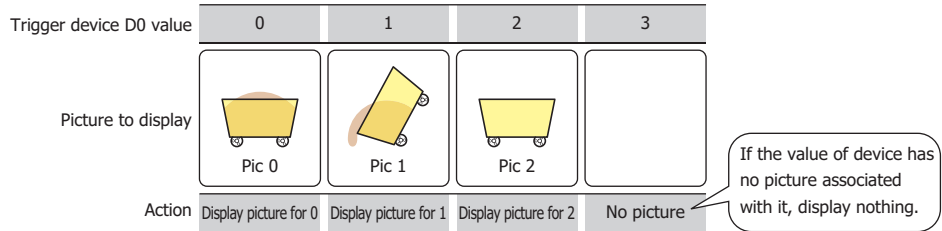

Trigger Device: Specifies the word device to use as the condition for switching pictures.

Click to display the Device Address Settings dialog box. For the device address configuration procedure, refer to Chapter 2 "5.1 Device Address Settings" on page 2-61.

This option can only be configured when **Bit** or **Value** is selected.



When the size of pictures to switch differs and the **Dynamic Size** check box is cleared, all the pictures are displayed with the same size as Pic0.

■ **Blink**

Select this check box to flash the displayed pictures.

■ **Dynamic Position *1**

Select this check box to move and display the picture by specifying the coordinates of the picture as values of devices.

X Point: Specifies the word device that is the X-coordinate of the picture.

Click to display the Device Address Settings dialog box. For the device address configuration procedure, refer to Chapter 2 "5.1 Device Address Settings" on page 2-61.

Y Point: Specifies the word device that is the Y-coordinate of the picture.

Click to display the Device Address Settings dialog box. For the device address configuration procedure, refer to Chapter 2 "5.1 Device Address Settings" on page 2-61.

Example: When the X-coordinate is D100 and the Y-coordinate is D101
 The picture is moved to the values of D100 and D101.

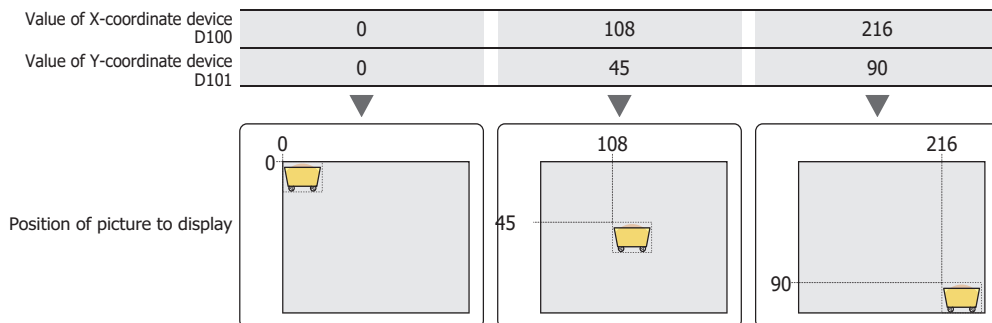

*1 Advanced mode only

■ Dynamic Size *1

Select this check box to scale the picture by specifying the size of the picture as values of devices.

Click to display the Device Address Settings dialog box. For the device address configuration procedure, refer to Chapter 2 "5.1 Device Address Settings" on page 2-61.

Width: Specifies the word device that is the width of the picture.

Click to display the Device Address Settings dialog box. For the device address configuration procedure, refer to Chapter 2 "5.1 Device Address Settings" on page 2-61.

Height: Specifies the word device that is the height of the picture.

Click to display the Device Address Settings dialog box. For the device address configuration procedure, refer to Chapter 2 "5.1 Device Address Settings" on page 2-61.

Example: When the width device is D100 and the height device is D101

The picture is displayed with its size scaled to the values of D100 and D101.

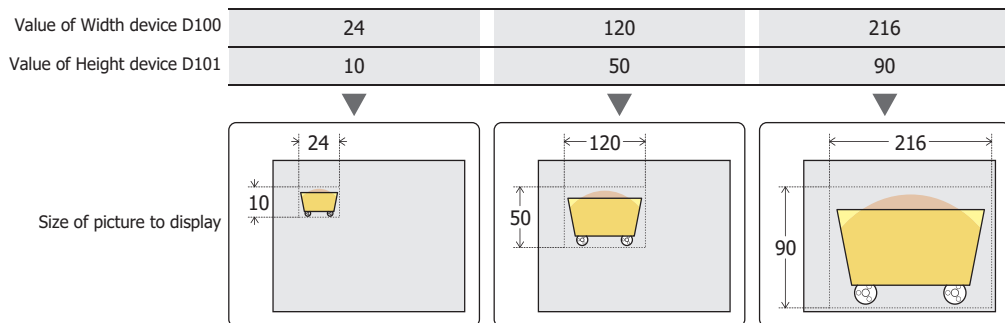

When the size of pictures to switch differs and the **Dynamic Size** check box is cleared, all the pictures are displayed with the same size as Pic0.



When moving and scaling pictures, set the values of devices so the picture is not moved or scaled outside the screen's display area.

*1 Advanced mode only

● View Tab

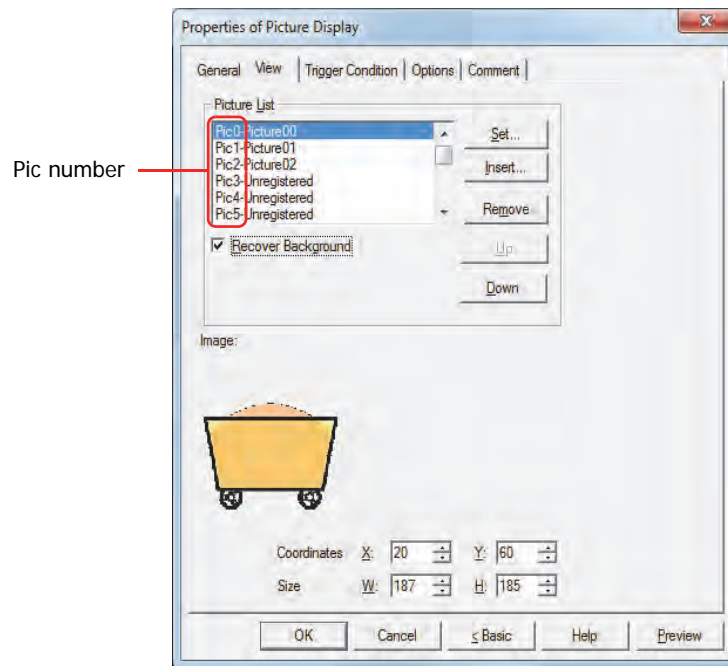

■ Picture List

Registers the pictures to display on the Picture Display. The picture number (Pic number) and the file name of the registered picture are displayed in the list.

- Set:** Registers a picture to the list. If you select a Pic number with a picture that is already registered, that number is overwritten with the new picture.
Select a Pic number on the list, and then click this button to display Picture Manager. Specify the picture to register with Picture Manager.
- Insert:** Inserts the picture in the position selected on the list.
Select the Pic number on the list at the position to insert the picture, and then click this button to display Picture Manager. Specify the picture to insert. The picture at the insertion point shifts one Pic number down. The picture cannot be inserted when pictures are registered to all the Pic numbers.
- Remove:** Deletes the registered picture from the list.
Select a Pic number on the list, and then click this button to delete the selected picture from the list.
- Up:** Shifts the selected settings upward in the list.
- Down:** Shifts the selected settings downward in the list.
- Recover Background*1:**

Select this check box to recover the background of the area where the picture had been displayed after the picture is switched. When this check box is cleared, the background is filled with the screen's **Background Color**.

When parts or drawings are arranged so they overlap the background of the Picture Display (below), the background of parts and drawings is displayed as follows if the Picture Display picture is hidden.

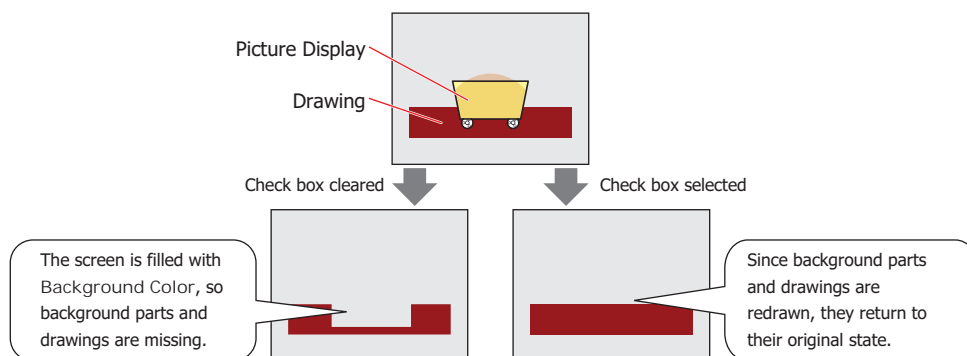

However, when the background part is the Alarm List Display, Alarm Log Display, bar chart, line chart, or pie chart, the missing sections will remain.

*1 Advanced mode only



If the **Recover Background** check box is selected, the number of parts that can be placed on a single screen decreases. If an error message appears when the Picture Display is displayed on the Touch screen, clear the **Recover Background** check box or reduce the number of parts.



- When the **Dynamic Position** check box or the **Dynamic Size** check box is selected on the **General** tab, the **Recover Background** check box cannot be selected.
- When the **Recover Background** check box and the **Blink** check box on the **General** tab are selected, the picture is repeatedly displayed and hidden.

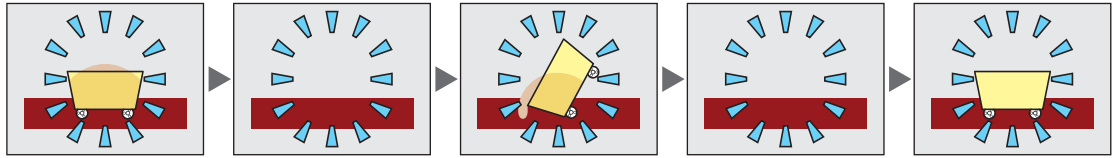

■ Image

Displays picture for the Pic number that has been selected in the **Picture List**.

■ Coordinates

X, Y: Sets the display position of parts using coordinates.
The X and Y coordinates of parts is defined relative to an origin at the top-left corner of the screen.

X: 0 to (Base Screen horizontal size - 1)

Y: 0 to (Base Screen vertical size - 1)

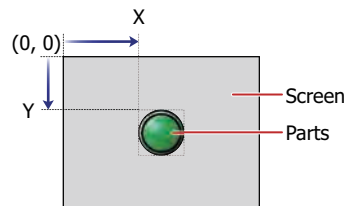

■ Size

W, H: Sets width and height to define the size of parts.

W: 2 to (Base Screen horizontal size)

H: 2 to (Base Screen vertical size)

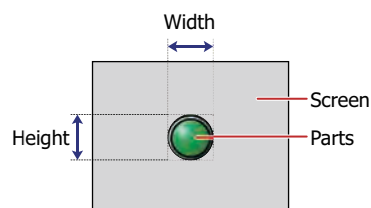

● **Trigger Condition Tab**

The **Trigger Condition** tab is displayed in Advanced mode.

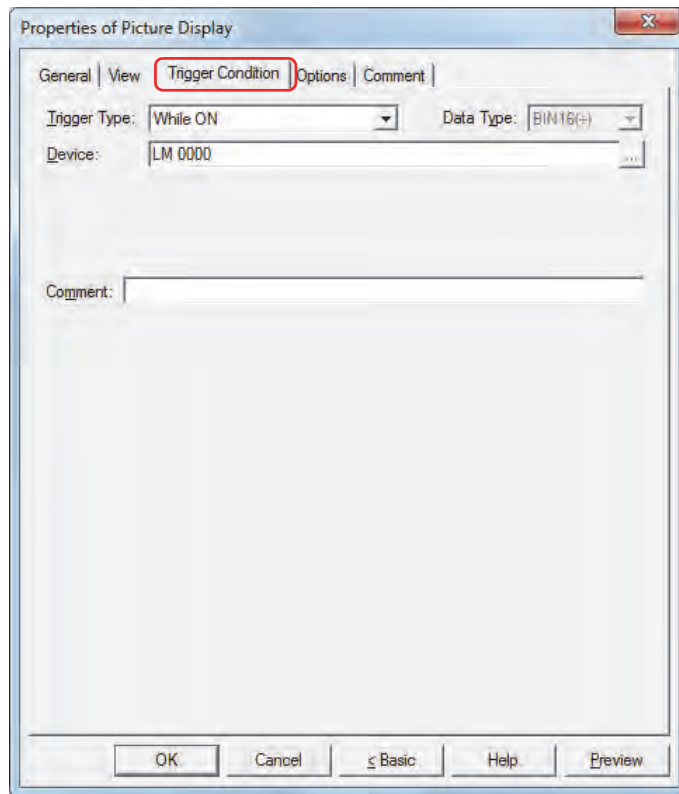

The Picture Display is enabled while the condition is satisfied, and it is disabled while the condition is not satisfied.

Example: When **Trigger Type** is **While ON**, **Device** is LM0

While LM0 is 0, the condition is not satisfied and the Picture Display does not display the picture.

While LM0 is 1, the condition is satisfied and the Picture Display displays the picture.

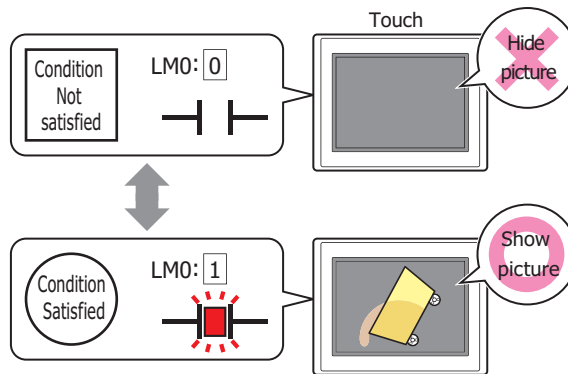

■ **Trigger Type**

Selects the condition to enable the Picture Display from the following.

Always Enabled: The Picture Display is always enabled.

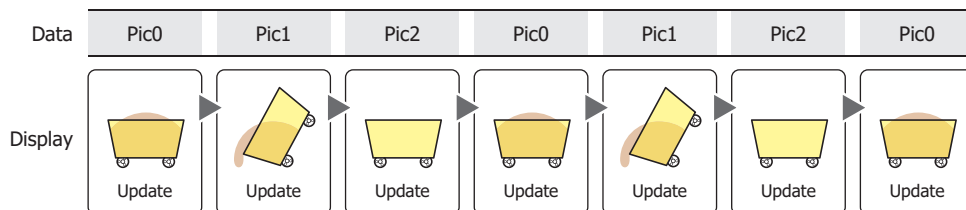

While ON: Enables the Picture Display when the value of device is 1.
Example: When **While not satisfying the condition** is **Not update Picture data**

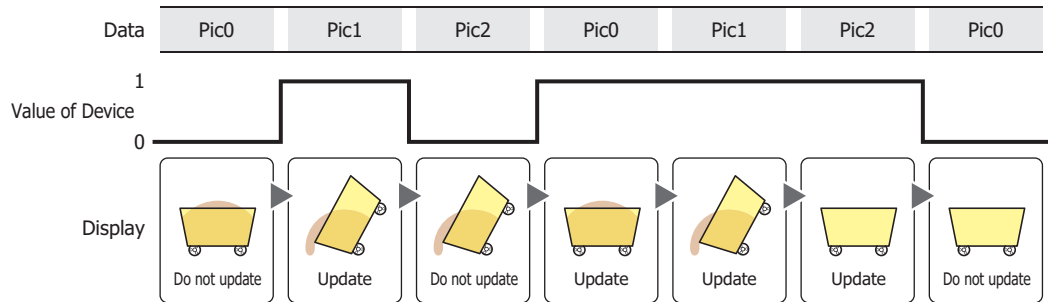

While OFF: Enables the Picture Display when the value of device is 0.
Example: When **While not satisfying the condition** is **Not update Picture data**

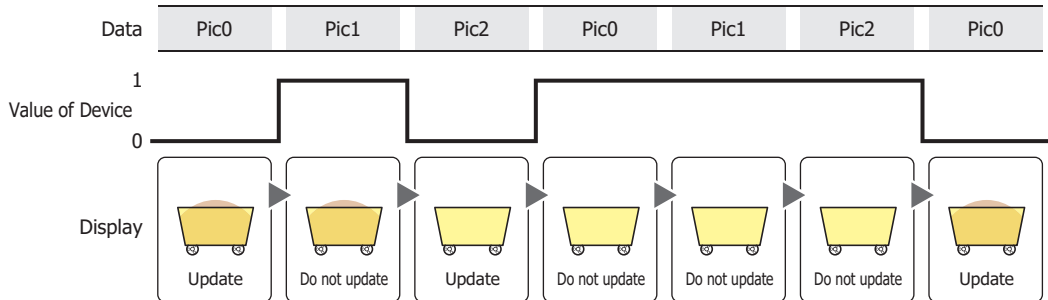

While satisfying the condition:

Enables the Picture Display when the condition is satisfied.
Example: When **While not satisfying the condition** is **Not update Picture data**

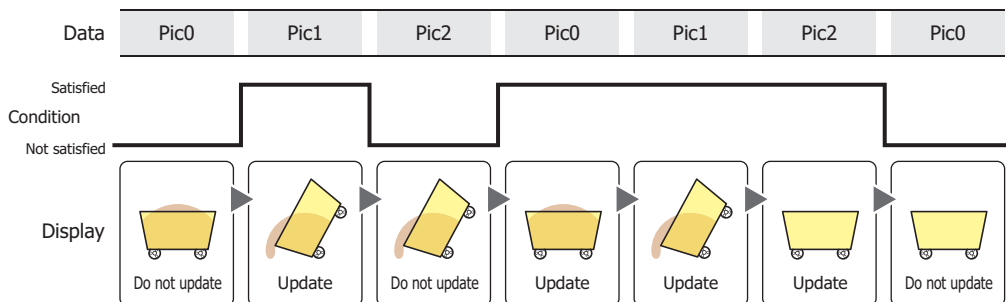

■ Data Type

Selects the data type handled by the condition formula.
Can only be set if **While satisfying the condition** is selected as **Trigger Type**.
For details, refer to Chapter 2 "1.1 Available Data" on page 2-1.

■ Device

Specifies the bit device or bit of the word device to serve as condition.
Can only be set if **While ON** or **While OFF** is selected as **Trigger Type**.

Click to display the Device Address Settings dialog box. For the device address configuration procedure, refer to Chapter 2 "5.1 Device Address Settings" on page 2-61.

■ Condition

Sets the condition formula.
Can only be set if **While satisfying the condition** is selected as **Trigger Type**.

Click to display the Trigger Condition Settings dialog box. For the conditional expression configuration procedure, refer to Chapter 2 "5.2 Setting Conditional Expressions" on page 2-63.

■ Comment

Enter a comment about trigger conditions. The maximum number is 80 characters.

● Options Tab

The **Options** tab is displayed in Advanced mode.

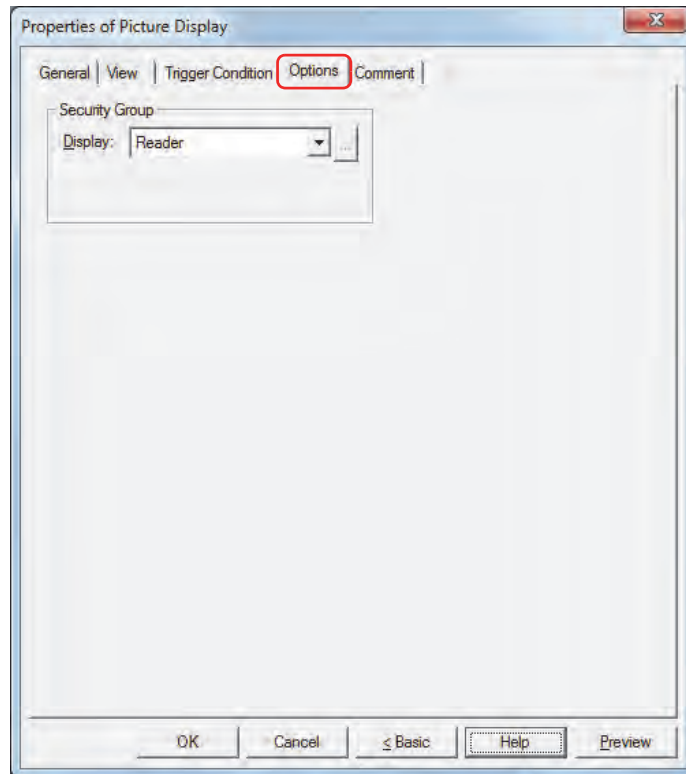

■ Security Group

Security groups are a security function for restricting the display and operation of parts.

Display: Selects the security group for which display of parts is restricted. (Default: None)

None: No security function is used.



Administrator, Operator, Reader: Three security groups are set up by default.

Click  to display the Security Group Settings dialog box. If you create a security group on the Security Group Settings dialog box, you can select that created group. For details, refer to Chapter 21 "2.2 Adding and Editing Security Groups" on page 21-15.



For details about security functions, refer to Chapter 21 "User Accounts and the Security Function" on page 21-1.

Example: If the user and security group for a part are set as follows:

User Name	 User1	 User2
Security Group	None	Group A

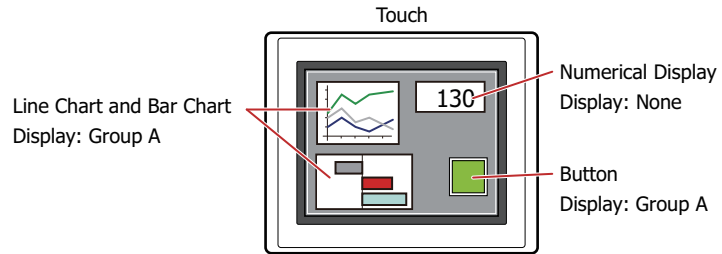

For User 1, who is not included in the specified security group, Group A parts are not displayed.
 If the Password Screen is now opened and a switch is made to User 2 of Group A, Group A parts are displayed.

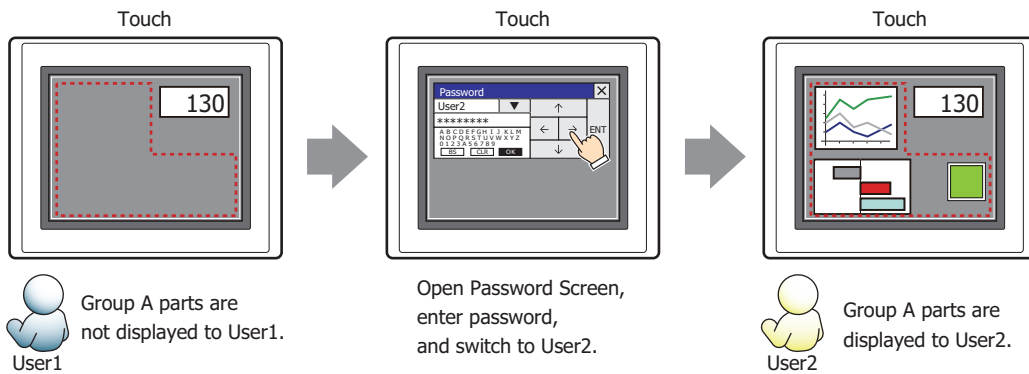

● Comment Tab

The **Comment** tab is used to specify the parts arranged on the editing screen, and the popup text displayed when the mouse pointer is placed close to **No.**, **Name**, or **Type** in the object list.



When there are multiple parts of the same shape on the screen, this feature makes it possible to distinguish between the parts without displaying the Properties dialog box for each part, by just mousing over the part.

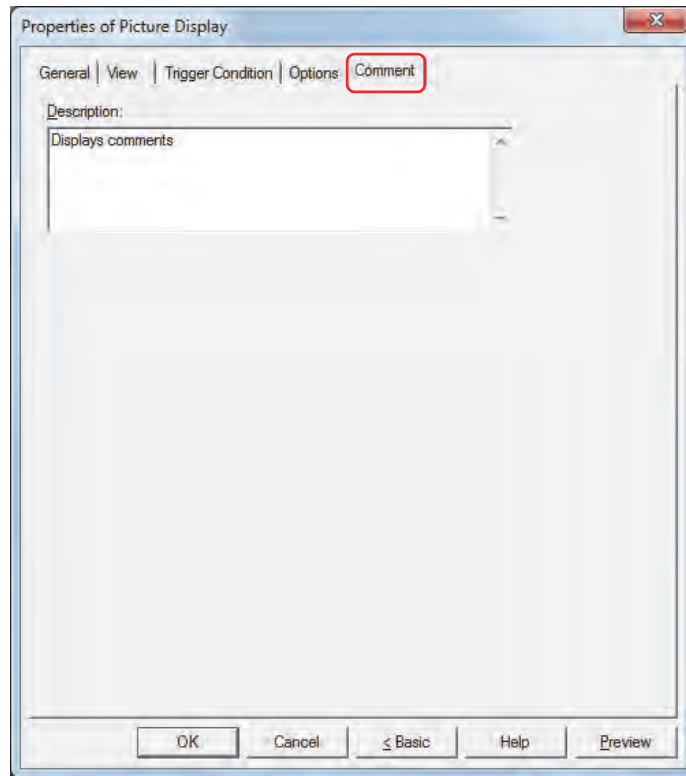

■ Description

Enter a comment about parts. The maximum number is 80 characters.

Example: When mousing over the Picture Display on the editing screen

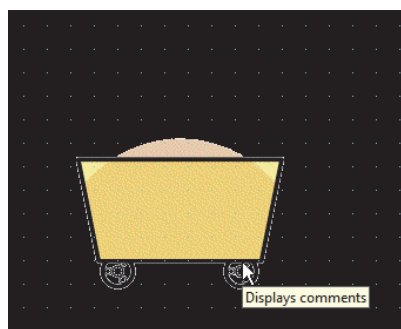

4 Message Display

4.1 How the Message Display is Used

The Message Display is used to constantly display messages registered in advance and to display text read from values of word devices as character codes.

The Message Display can perform the following functions.

- Display messages

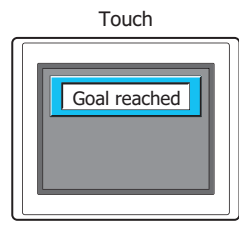

- Display text according to value of devices

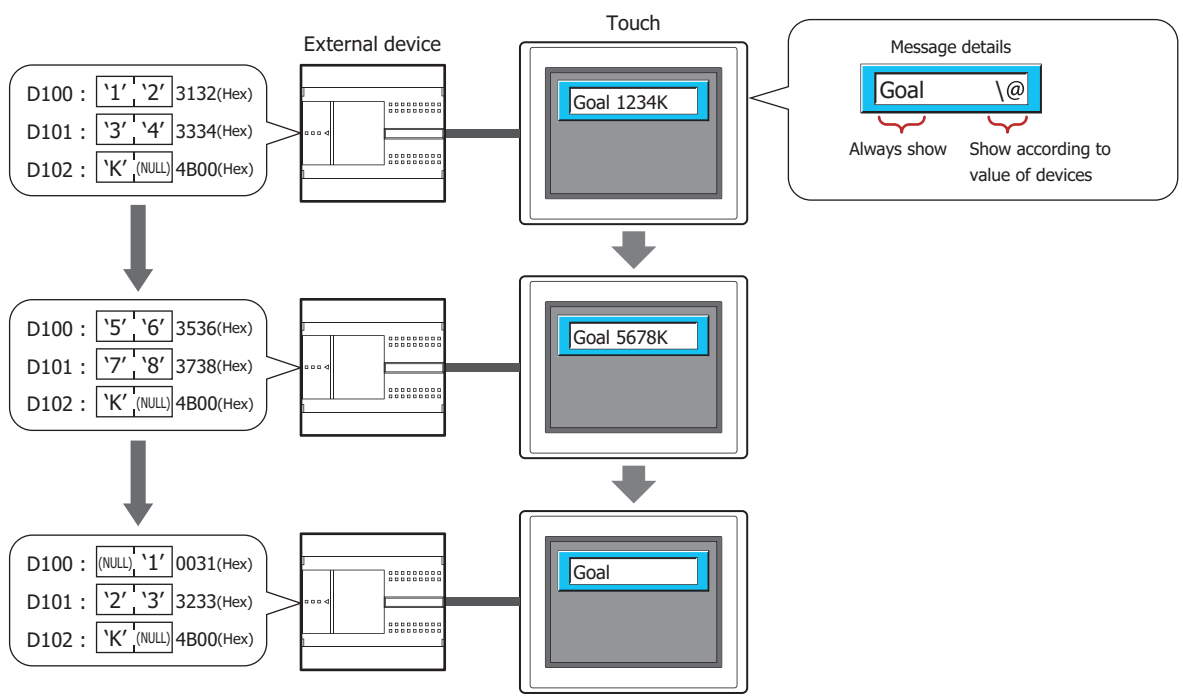

	D100	'1' '2' 3132(Hex)	'5' '6' 3536(Hex)	(NULL) '1' 0031(Hex)
Value of Reference Devices	D101	'3' '4' 3334(Hex)	'7' '8' 3738(Hex)	'2' '3' 3233(Hex)
	D102	'K' (NULL) 4B00(Hex)	'K' (NULL) 4B00(Hex)	'K' (NULL) 4B00(Hex)
Display		Goal 1234K	Goal 5678K	Goal
Action		Display always shown text and text shown according to value of device	Display always shown text and text shown according to value of device	Display only always shown text Do not show if upper byte of the Reference Device starting address is 00 (NULL)

- Scroll messages

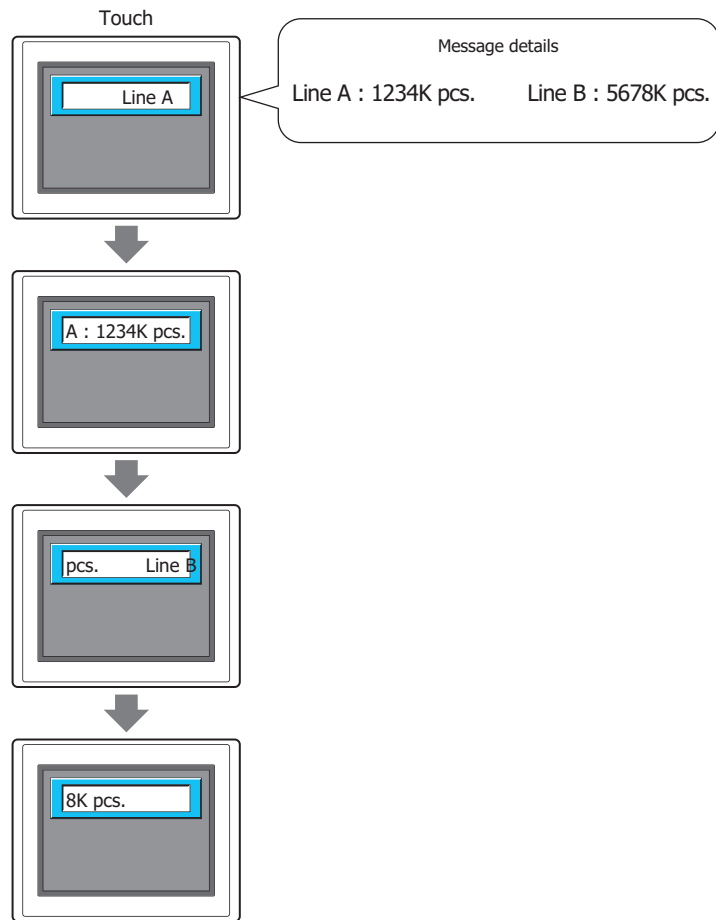

- Change the message and plate color according to a value of device

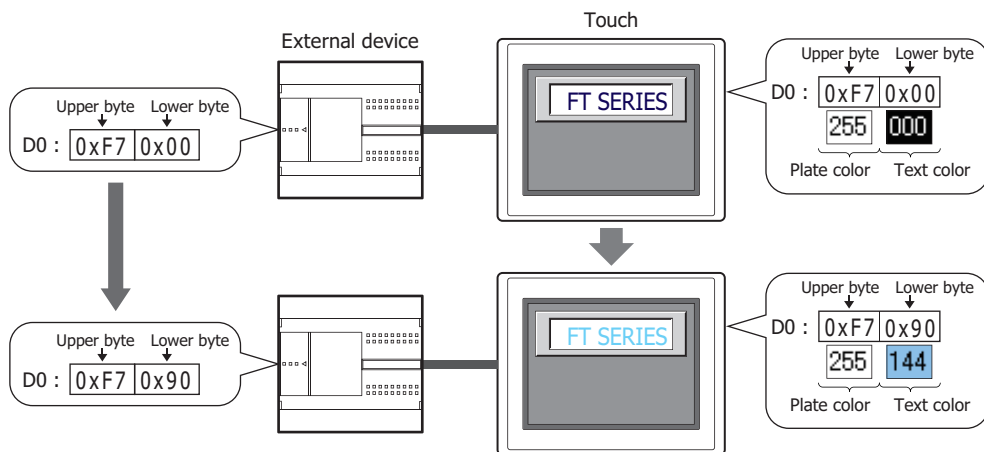

4.2 Message Display Configuration Procedure

This section describes the configuration procedure for Message Displays.

- 1 On the **Home** tab, in the **Parts** group, click **Data Displays**, and then click **Message Display**.

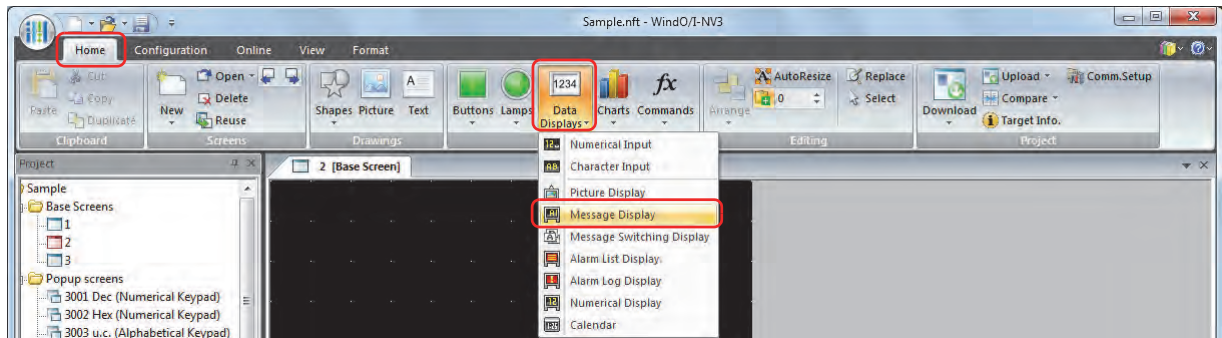

- 2 Click a point on the edit screen where you want to place the Message Display.
- 3 Double-click the dropped Message Display and a Properties dialog box will be displayed.
- 4 Change the settings on each tab as necessary.

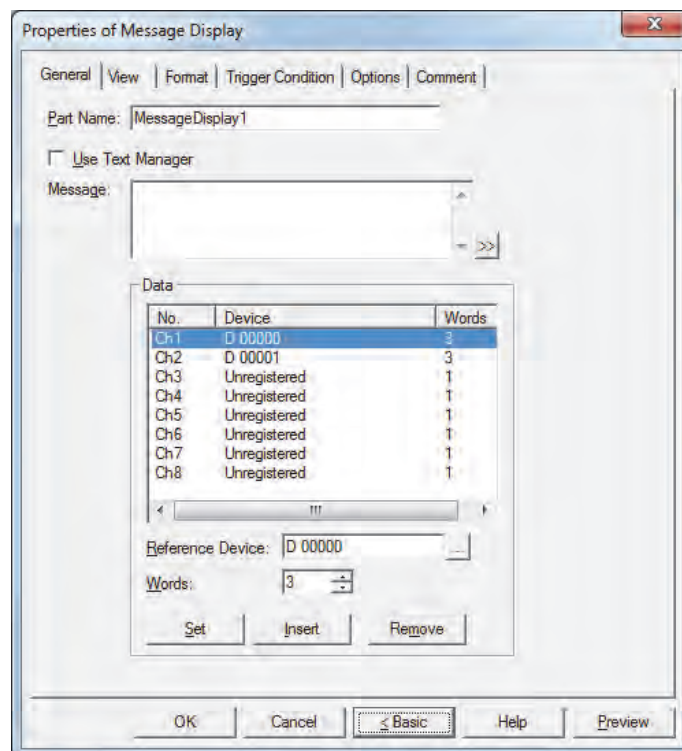

The **Trigger Condition** tab and **Options** tab only appear in Advanced mode. To switch to Advanced mode, click **Advanced**.

4.3 Properties of Message Display Dialog Box

This section describes items and buttons on the properties dialog box.

● General Tab

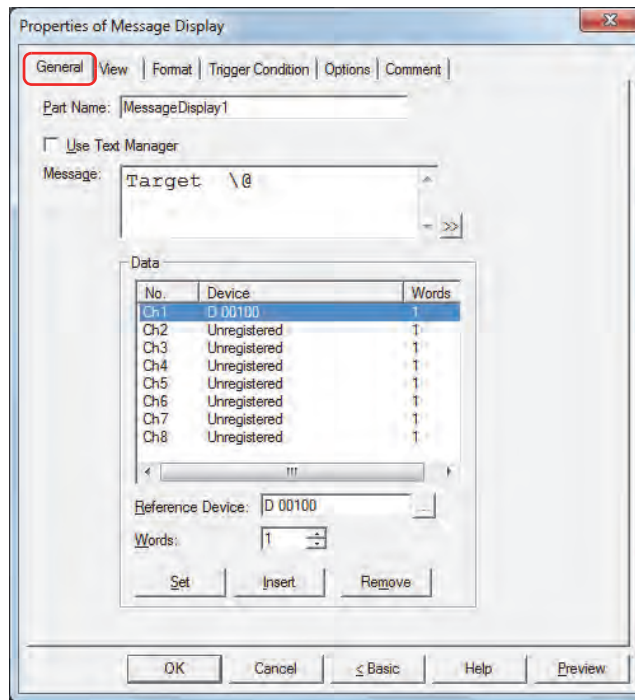

■ Part Name

Enter a name for the part. The maximum number is 20 characters.

■ Use Text Manager

Select this check box to use text registered in Text Manager.

■ Text ID

Specifies the Text Manager ID number (1 to 32000) when using text registered in Text Manager.

Click  to display Text Manager.

This option can only be configured when the **Use Text Manager** check box is selected.



To read values of word devices as character codes with text registered in Text Manager and display it as text, enter "\@" (1 to 8) in **Text** for the **Text ID** at the position to display the value of device as text. The channels configured under **Data** are allocated in order from the first "\@". The text is displayed according to the values of devices in order from the first reference device.

However, in the following situations "\@" is not handled as text to display according to values of devices and is displayed unchanged.

- When **Font** is **Windows** for **Text ID** configured in Text Manager
- When the number of "\@" configured in **Text** for **Text ID** is greater than the number of channels configured with devices

(Text for the character codes corresponding to the values of devices is only displayed for the number of channels in order from the beginning.)

■ Message

Enter the text to display. The maximum number is 610 characters. You can enter multi-line messages by inserting a newline. To configure text to display according to values of devices, enter “\@” (1 to 8) at the location to read the values of word devices as character codes and display them as text. The channels configured under **Data** are allocated in order from the first “\@”. The text is displayed according to the values of devices in order from the first reference device.

Example: The device configured in Ch1 is allocated to the first “\@”. The device configured in Ch2 is allocated to the second “\@”.

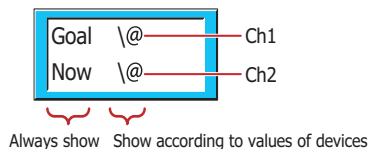

The characters that can be entered vary based on to the font selected for **Font** on the **Format** tab. For details, refer to Chapter 2 “1.2 Available Text” on page 2-5.

This option can only be configured if the **Use Text Manager** check box is cleared.



- To enter Unicode characters, click  to display the Unicode Input dialog box. Enter the characters in the Unicode Input dialog box, and then click **OK**.
- To display the backslash (\), enter a backslash (\) before the backslash (\).
Example: \\

■ Data

These options are used to register or edit the devices with values to read as character codes.

- (Settings): Lists the settings for the text to display according to values of devices.
- No.: Shows the channel numbers (Ch1 to Ch8).
- Device: Shows the reference device configured for the channel.
- Words: Shows the number of words used by the reference device.
- Reference Device: Specifies the word device that stores the values read as character codes.
Click  to display the Device Address Settings dialog box. For the device address configuration procedure, refer to Chapter 2 “5.1 Device Address Settings” on page 2-61.
Set the values of devices to the character codes for the language used. For details, refer to Chapter 2 “Character Code Table” on page 2-14.
- Words: Specifies the number of words for the length of the text to display (1 to 64). Values of devices for the configured amount of words are read as character codes starting from the device address set by **Reference Device**. 2 single-byte characters can be displayed by 1 word.
- Set: Registers the settings for the text to display according to values of devices to the list. If you select a number that is already registered, that number is overwritten with the new settings. Select a Ch number on the list, and then click this button to register the **Reference Device** and **Words** settings.
Always register the settings from Ch1.
- Insert: Inserts the settings in the position selected on the list.
Select a Ch number on the list, and then click this button to insert the **Reference Device** and **Words** settings. The settings at the insertion point shift down one line. Settings cannot be inserted if all the Ch numbers are configured.
- Remove: Deletes the registered settings from the list.
Select a Ch number, and then click this button to delete the selected settings from the list.

● View Tab

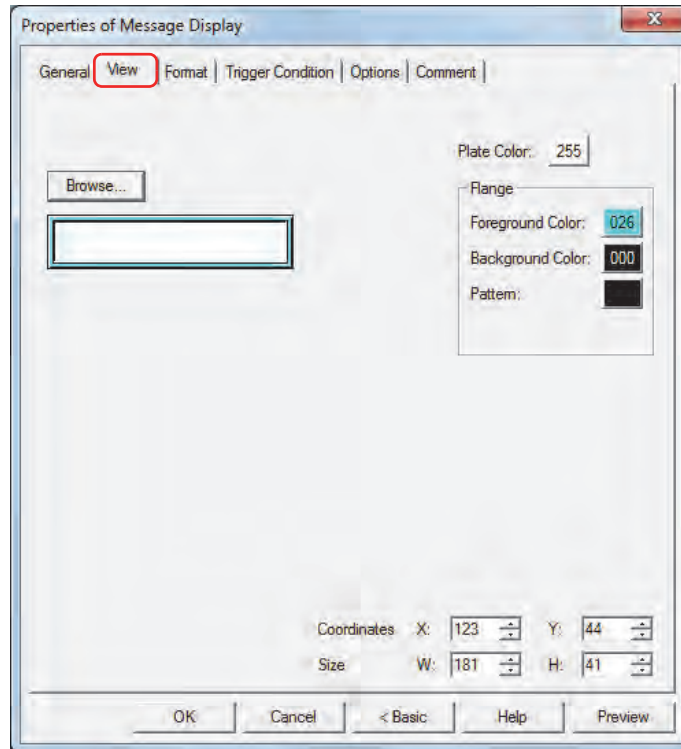

■ Browse

Select the type of graphic to represent the part from the list of graphics. Click this button to display the View Browser.

■ Plate Color

Selects the plate color of the standard graphic (color: 256 colors, monochrome: 8 shades).

Click the **Color** button to display the Color Palette. Select a color from the Color Palette.

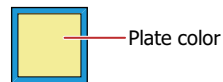

■ Flange

Foreground Color, Background Color:

Selects the foreground and background colors of the flange of the standard graphic (color: 256 colors, monochrome: 8 shades).

Click the **Color** button to display the Color Palette. Select a color from the Color Palette.

Pattern:

Selects a pattern for the flange of the standard graphic.

Click the **Pattern** button to display the Pattern Palette. Select a pattern from the Pattern Palette.

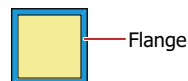

■ Coordinates

- X, Y: Sets the display position of parts using coordinates.
 The X and Y coordinates of parts is defined relative to an origin at the top-left corner of the screen.
- X: 0 to (Base Screen horizontal size - 1)
- Y: 0 to (Base Screen vertical size - 1)

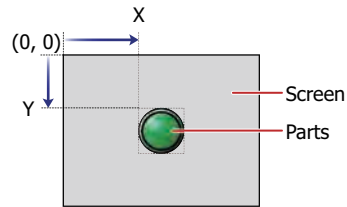

■ Size

- W, H: Sets width and height to define the size of parts.
- W: 5 to (Base Screen horizontal size)
- H: 5 to (Base Screen vertical size)

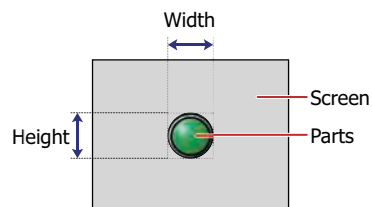

● Format Tab

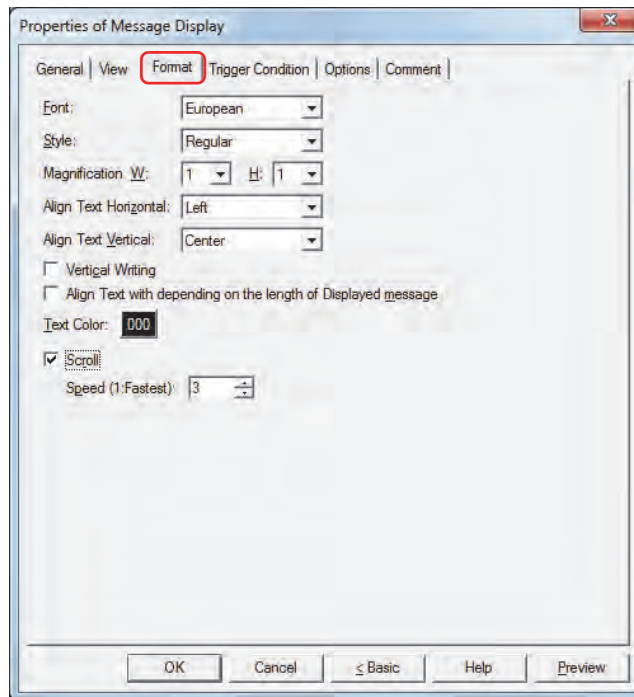

■ Font

Selects the font for displaying text from the following.

Japanese, European, Chinese, Taiwanese, Korean, Central European, Baltic, Cyrillic

The characters that can be displayed depend on the font. For details, refer to Chapter 2 “1.2 Available Text” on page 2-5.

■ Style

Selects **Regular** or **Bold** for text style.

■ Magnification

W, H: Selects text magnification (0.5, 1 to 8).

■ Align Text Vertical

Selects the text alignment in the vertical direction from the following.

Top, Center, Bottom, Center-Top

Set to **Center** when the **Vertical Writing** check box is selected.

For details, refer to Appendix “5 Text Alignment” on page A-5.

■ Align Text Horizontal

Selects the text alignment in the horizontal direction from the following.

Left, Center, Right

For details, refer to Appendix “5 Text Alignment” on page A-5.

■ Vertical Writing

Select this check box when displaying text vertically.



When the **Vertical Writing** check box is selected, take care about the following points. This is applicable for Windows supports East Asian characters.

- When there is a mixture of double-byte and single-byte characters, the half-width characters are left-aligned.

Aligned to
 A left edge
 B
 C
 D
 E
 F

- Dashes are displayed horizontally. Symbols representing voiced and semi-voiced sounds of single-byte characters are shown as follows.

Horizontal display

X	o	
-	'	
a	c	Next
x	l	characters
i	o	
s	c	
	k	

- When using text displayed according to values of devices, the characters are counted as single-byte characters and the display area for the characters is indicated by dotted lines. Therefore, when the text to display according to values of devices is double-byte characters, the display area actually required differs from the area indicated by the dotted lines.

Example: When 1 word of text to display according to values of devices is set to vertical writing, the vertical size of the dotted lines is displayed as 2 single-byte characters.

2 single-byte chars. 1 double-byte char.

Dotted line frame is 2 chars. High

■ Align Text depending on the length of the Displayed message *1

Select this check box to align text as standard to the number of characters that will be displayed.

When cleared, the maximum number of characters (set number of words) is always aligned as standard.

Example: When there are 2 characters of text to always display on the first line, 6 characters of text to always display on the second line and 6 characters of text (3 words) to display according to values of device, **Align Text Horizontal** is set to **Center**, and the text to display according to values of device is blank (when only 6 characters are always displayed on the second line)

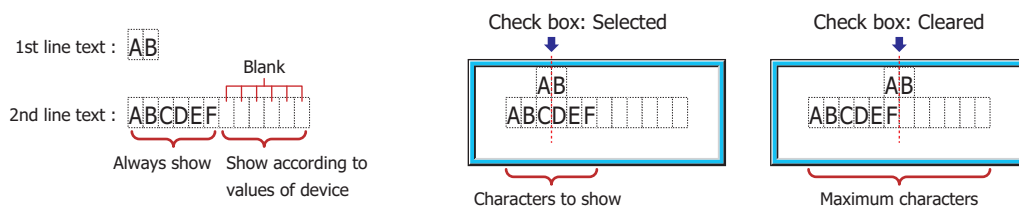

■ Text Color

Selects the color of displayed text (color: 256 colors, monochrome: 8 shades).

Click the **Color** button to display the Color Palette. Select a color from the Color Palette.

*1 Advanced mode only

■ **Scroll***1

Select this check box to enable scrolling display displaying of messages.

Speed (1: Fastest): Sets the scrolling speed (1 to 10). 1 is fastest, 10 is slowest.



When the **Scroll** check box is selected operation is follows.

- Messages that include CRs are displayed without the CRs.
- Messages scroll in the direction in which the text is drawn.
- When the text displayed according to values of devices, the text color, or the displayed text changes, the message is scrolled from the beginning.



When the **Scroll** check box is selected, take care about the following points.

- This setting is only enabled when the **Enable** check box in the Blink group box on the **Option** tab is cleared.
- The number of parts that can be arranged on a single screen decreases. If the Touch displays an error message, clear the **Scroll** check box, or reduce the number of parts on the screen.
- When the scan time of the Touch is long, scrolling speed may become slow.

*1 Advanced mode only

● Trigger Condition Tab

The **Trigger Condition** tab is displayed in Advanced mode.

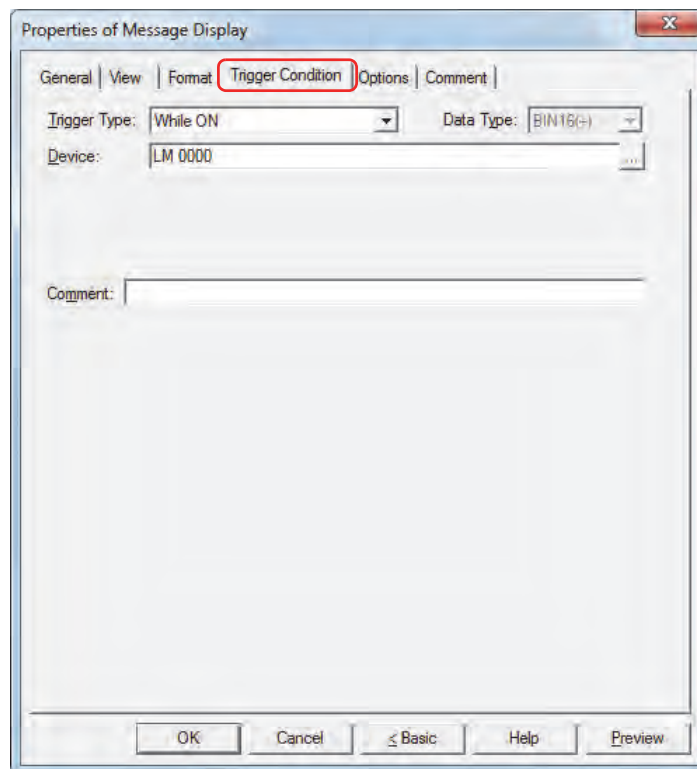

The Message Display is enabled while the condition is satisfied, and it is disabled while the condition is not satisfied. When disabled, the plate and flange are displayed, but the message is not displayed.

Example: When **Trigger Type** is **While ON**, **Device** is LM0

While LM0 is 0, the condition is not satisfied and the Message Display does not display the message.

While LM0 is 1, the condition is satisfied and the Message Display displays the message.

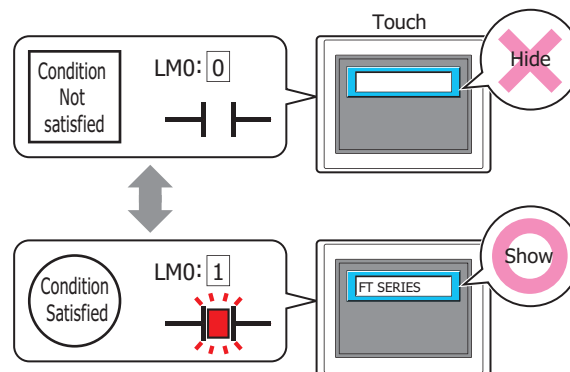

■ Trigger Type

Selects the condition to enable the Message Display from the following.

Always Enabled: The Message Display is always enabled.

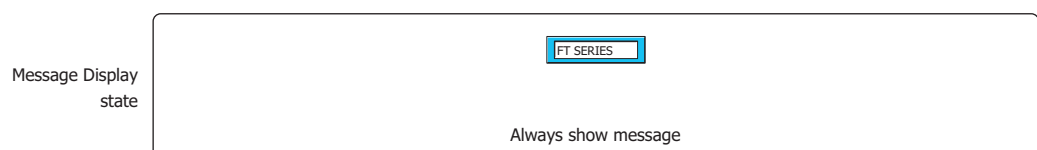

While ON: Enables the Message Display when the value of device is 1.
 Example: When **While not satisfying the condition** is **Not display message**.

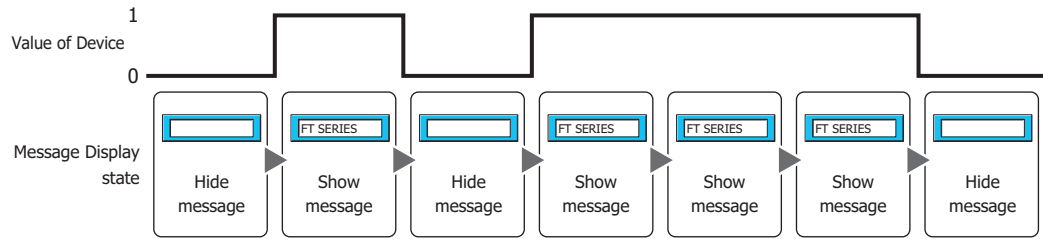

While OFF: Enables the Message Display when the value of device is 0.
 Example: When **While not satisfying the condition** is **Not display message**.

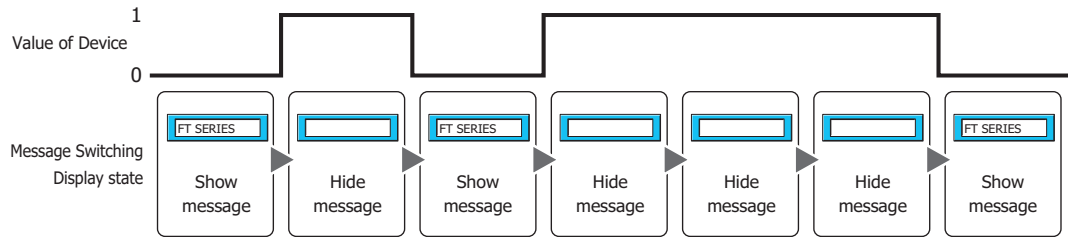

While satisfying the condition:

Enables the Message Display when the condition is satisfied.
 Example: When **While not satisfying the condition** is **Not display message**.

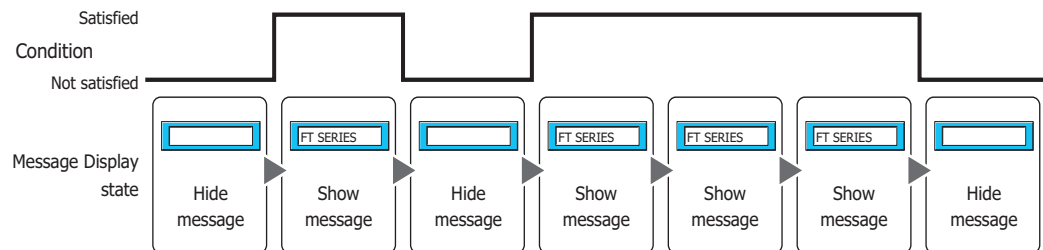

■ Data Type

Selects the data type handled by the condition formula.
 Can only be set if **While satisfying the condition** is selected as **Trigger Type**.
 For details, refer to Chapter 2 "1.1 Available Data" on page 2-1.

■ Device

Specifies the bit device or bit of the word device to serve as condition.
 Can only be set if **While ON** or **While OFF** is selected as **Trigger Type**.

Click to display the Device Address Settings dialog box. For the device address configuration procedure, refer to Chapter 2 "5.1 Device Address Settings" on page 2-61.

■ Condition

Sets the condition formula.
 Can only be set if **While satisfying the condition** is selected as **Trigger Type**.

Click to display the Trigger Condition Settings dialog box. For the conditional expression configuration procedure, refer to Chapter 2 "5.2 Setting Conditional Expressions" on page 2-63.

■ Comment

Enter a comment about trigger conditions. The maximum number is 80 characters.

● **Options** Tab

The **Options** tab is displayed in Advanced mode.

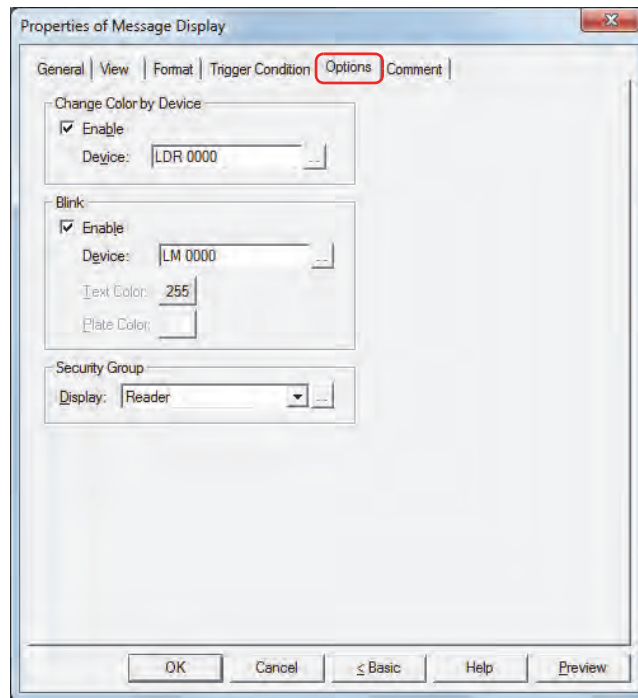

■ **Change Color by Device**

Switches the message or plate color.

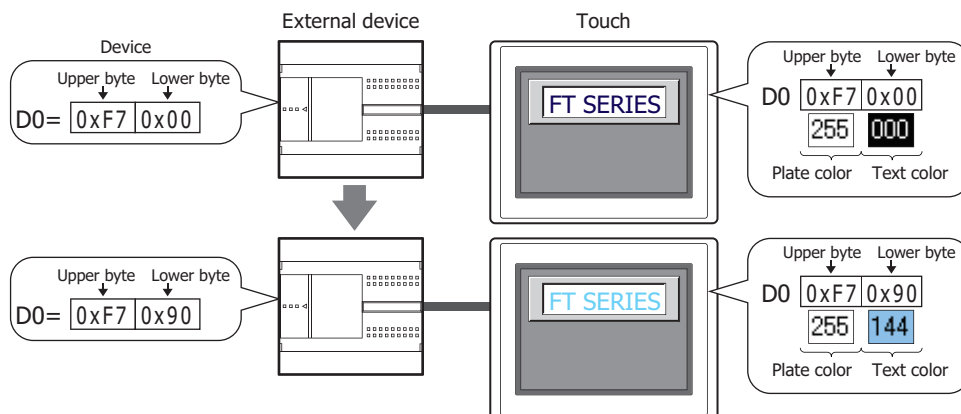

Enable: Select this check box to switch the color of the message or plate depending on the value of device.

Device: Specifies the word device that stores the color data for the message or plate.

Click to display the Device Address Settings dialog box. For the device address configuration procedure, refer to Chapter 2 "5.1 Device Address Settings" on page 2-61.

Color data assignments that are stored to devices are given below.

Device	bit 15	Upper byte	bit 8	bit 7	Lower byte	bit 0
Address	Plate color			Text color		
Address+1	Plate color when blinking			Text color when blinking		

This uses address+1 to specify the text color and plate color when the **Enable** check box has been selected.

For color data, refer to Appendix "1 Color Number Correspondence Table" on page A-1.

Blink

Flashes the message or plate color.

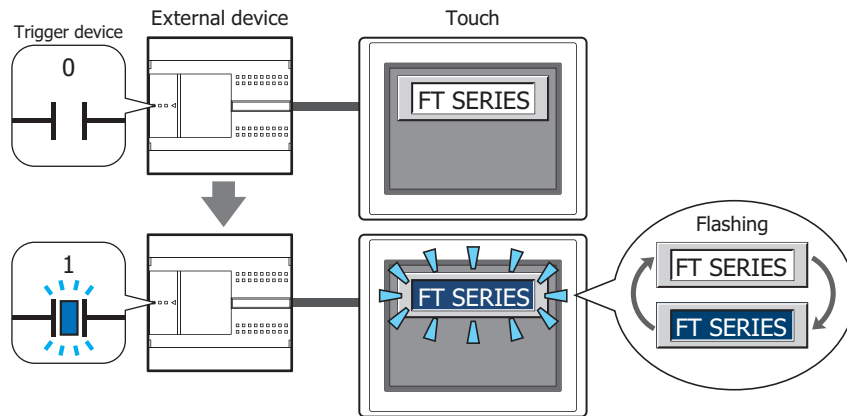

Enable: Turn this check box on to make messages flash.

Trigger device: Specifies the bit device that will be used as a condition to trigger flashing.

Click to display the Device Address Settings dialog box. For the device address configuration procedure, refer to Chapter 2 "5.1 Device Address Settings" on page 2-61.

When the value of device is 0, the color specified in **Text Color** on the **Format** tab or in **Plate Color** on the **View** tab will be displayed.

When the value of device is 1, the color displayed when the device is 0 and the color specified in **Text Color** or **Plate Color** will be displayed alternately.

Flash intervals are set in **Blinking Cycle** on the **System** tab in the Project Settings dialog box.

Text Color: This selects the color (color: 256 colors, monochrome: 8 shades) of text when flashing.

Click this button to display the Color Palette. Select a color from the Color Palette.

This can be set only when the **Enable** check box is cleared.

Plate Color: This selects the plate color (color: 256 colors, monochrome: 8 shades) when flashing.

Click this button to display the Color Palette. Select a color from the Color Palette.

This can be set only when the **Enable** check box is cleared.



Text Color and **Plate Color** are specified in **Device** under **Change Color by Device** when the **Enable** check box has been selected in both **Blink** and **Change Color by Device**.

Example: When the Device is D0

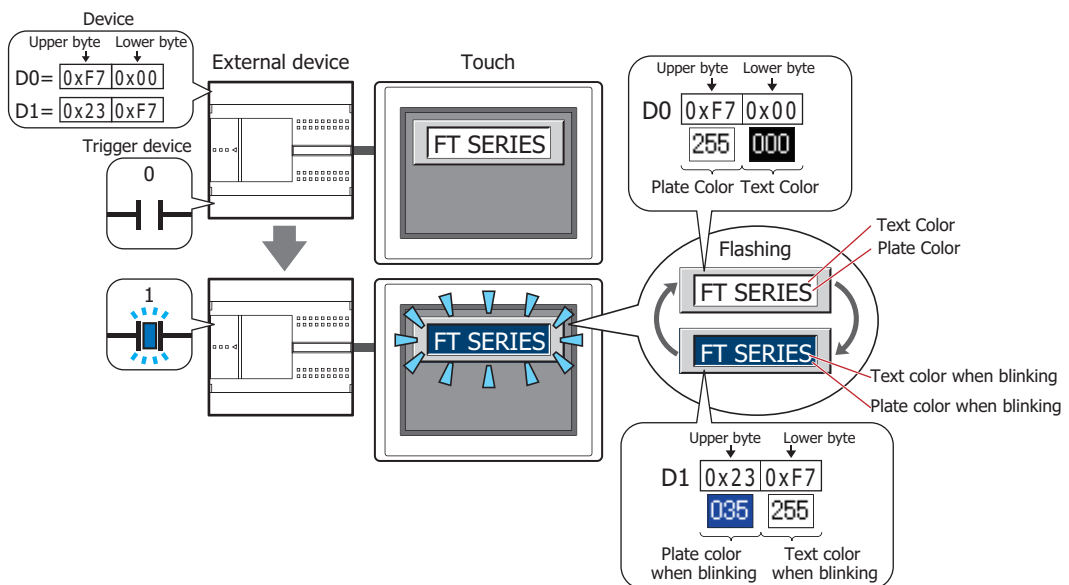

Security Group

Security groups are a security function for restricting the display and operation of parts.

Display: Selects the security group for which display of parts is restricted. (Default: None)

None: No security function is used.



Administrator, Operator, Reader: Three security groups are set up by default.

Click  to display the Security Group Settings dialog box. If you create a security group on the Security Group Settings dialog box, you can select that created group. For details, refer to Chapter 21 "2.2 Adding and Editing Security Groups" on page 21-15.



For details about security functions, refer to Chapter 21 "User Accounts and the Security Function" on page 21-1.

Example: If the user and security group for a part are set as follows:

User Name	 User1	 User2
Security Group	None	Group A

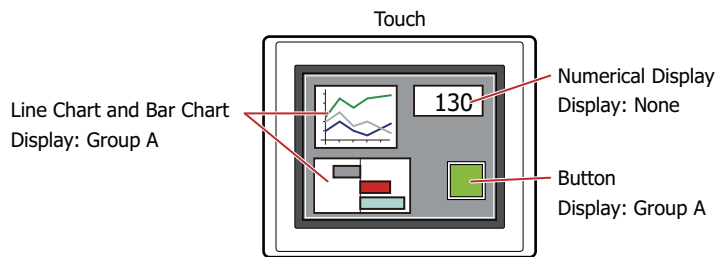

For User 1, who is not included in the specified security group, Group A parts are not displayed.

If the Password Screen is now opened and a switch is made to User 2 of Group A, Group A parts are displayed.

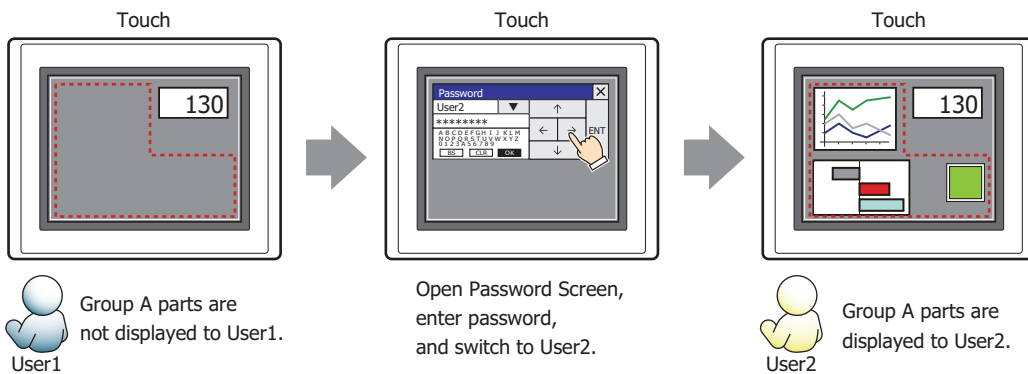

● Comment Tab

The **Comment** tab is used to specify the parts arranged on the editing screen, and the popup text displayed when the mouse pointer is placed close to **No.**, **Name**, or **Type** in the object list.



When there are multiple parts of the same shape on the screen, this feature makes it possible to distinguish between the parts without displaying the Properties dialog box for each part, by just mousing over the part.

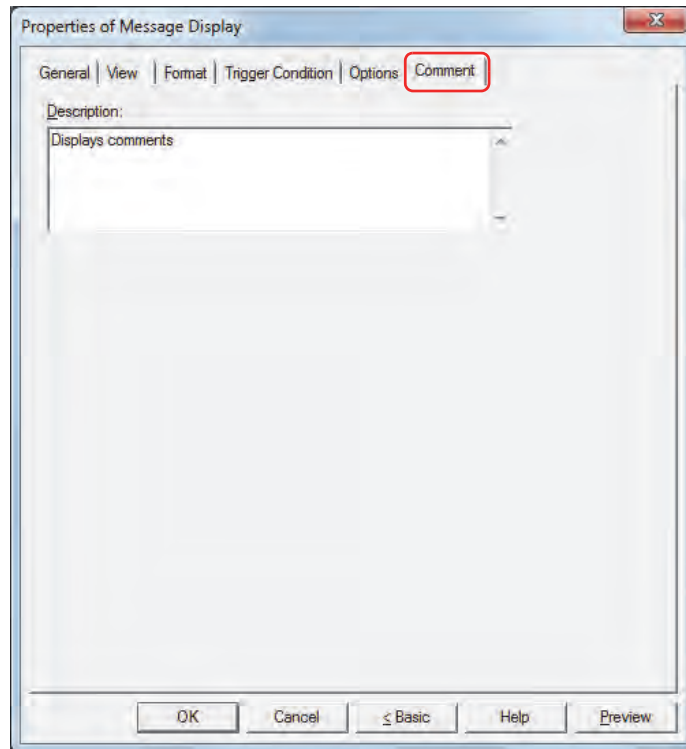

■ Description

Enter a comment about parts. The maximum number is 80 characters.

Example: When mousing over the Message Display on the editing screen

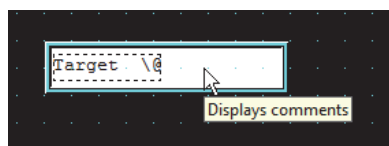

4.4 String Data Storage Method

The values of devices read as character codes are stored in the upper byte and lower byte of words according to the **Storage Method of String Data** setting. **Storage Method of String Data** is configured on the **System** tab in the Project Settings dialog box.

For details, refer to Chapter 3 “3.1 System Tab” on page 3-19.

Example: When reference device D100 = 3132 (Hex), D101 = 3334 (Hex), D102 = 3500 (Hex)

- When **from Upper byte** is selected for **Storage Method of String Data**

Device	Stored value		Displayed string
	Upper byte	Lower byte	
D100	31 (Hex)	32 (Hex)	12
D101	33 (Hex)	34 (Hex)	34
D102	35 (Hex)	0	5

NULL terminating character

- When **from Lower byte** is selected for **Storage Method of String Data**

Device	Stored value		Displayed string
	Upper byte	Lower byte	
D100	32 (Hex)	31 (Hex)	21
D101	34 (Hex)	33 (Hex)	43
D102	0	35 (Hex)	

NULL terminating character

When handling values of devices as character codes, 0 is handled as the NULL terminating character to end the string. Therefore, when the upper byte is 0, nothing is displayed.



- When handling values of devices as character codes, 0 is handled as the NULL terminating character to end the string. Therefore, when the upper byte is 0, nothing is displayed.
- To display only a single character, set the lower byte to 0.

Example: To display a single-byte 7

3700(Hex)

5 Message Switching Display

5.1 How the Message Switching Display is Used

The Message Switching Display is used to switch the displayed message according to the value of a word device.

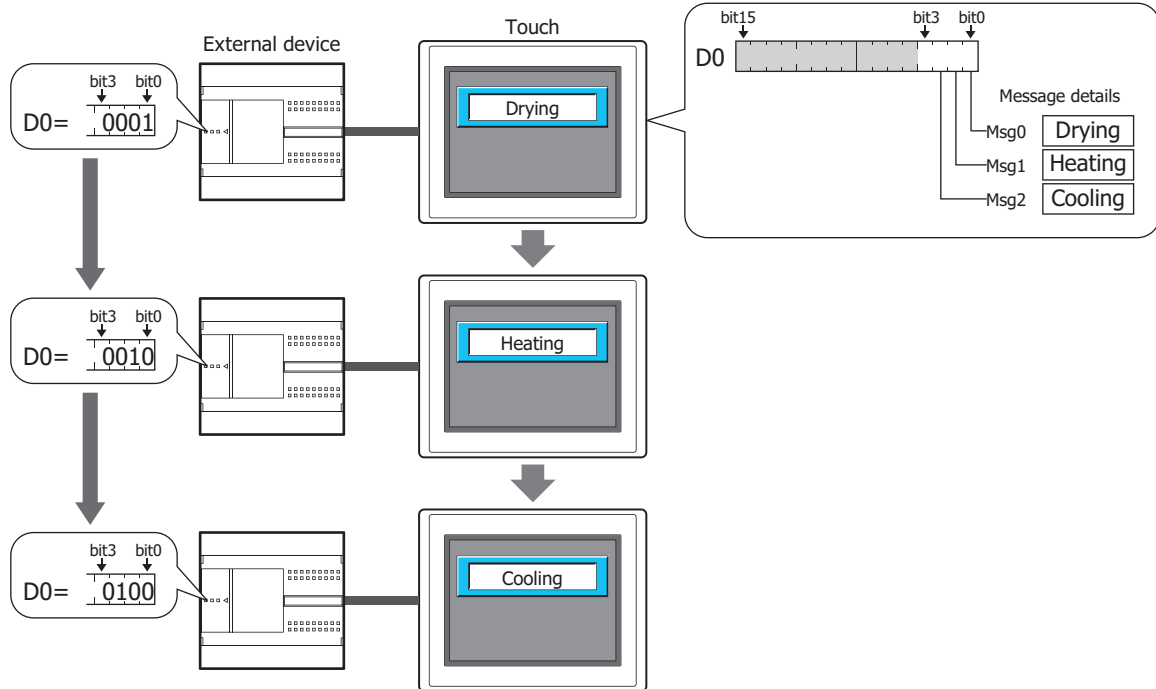

5.2 Message Switching Display Configuration Procedure

This section describes the configuration procedure for Message Switching Displays.

- 1 On the **Home** tab, in the **Parts** group, click **Data Displays**, and then click **Message Switching Display**.

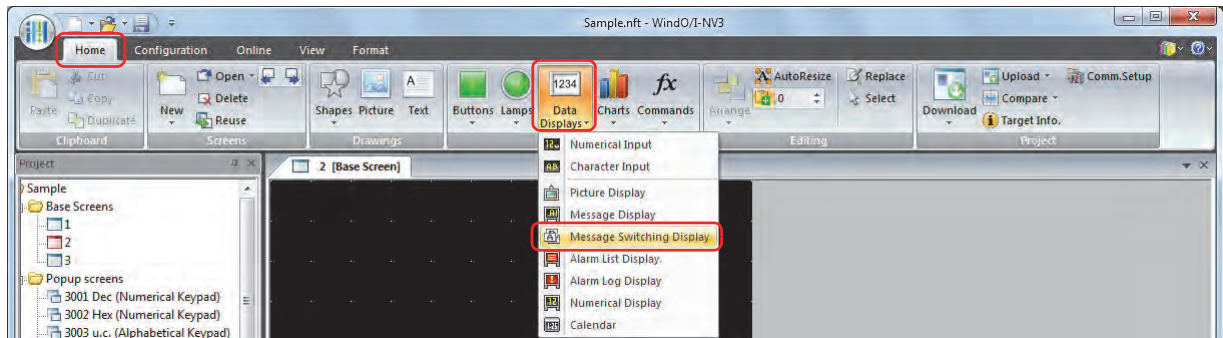

- 2 Click a point on the edit screen where you want to place the Message Switching Display.
- 3 Double-click the dropped Message Switching Display and a Properties dialog box will be displayed.
- 4 Change the settings on each tab as necessary.

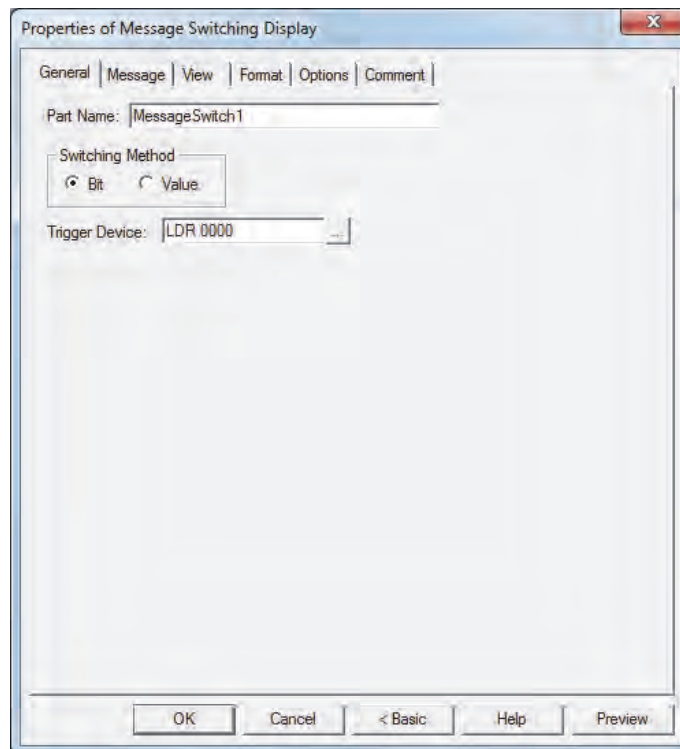

The **Options** tab only appears in Advanced mode.
To switch to Advanced mode, click **Advanced**.

5.3 Properties of Message Switching Display Dialog Box

This section describes items and buttons on the properties dialog box.

● **General Tab**

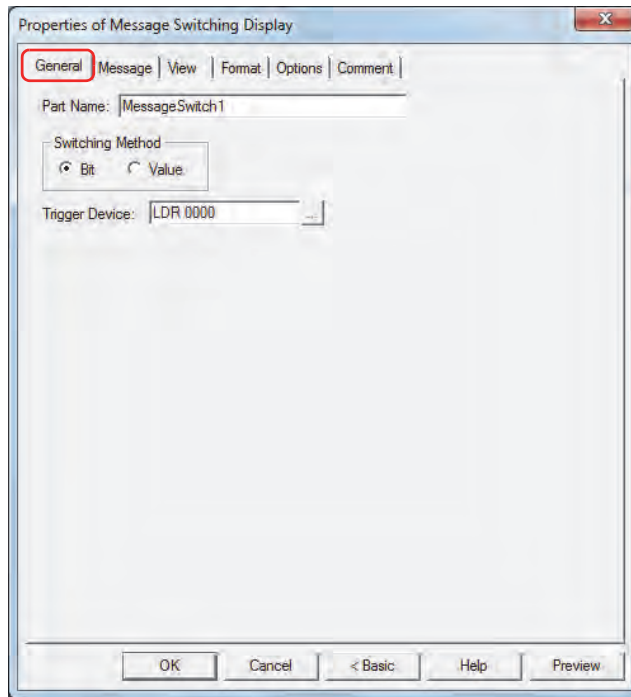

■ **Part Name**

Enter a name for the part. The maximum number is 20 characters.

■ **Switching Method**

Selects the method for switching message to display from the following. Messages are registered in **Settings** on the **Message** tab.

Bit: Switches the message to display according to the status of bits in a device.

Example: When **Bit** is selected and the bits of trigger device D0 are allocated to the following messages.

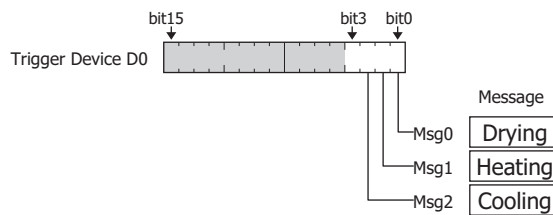

Switches the message to display according to the status of the bits.

Trigger Device D0 bit state	0001	0010	0100	1000	1110
Message to display	Drying (Msg0)	Heating (Msg1)	Cooling (Msg2)		Heating (Msg1)
Action	Display Msg0	Display Msg1	Display Msg2	No message	Display Msg1

If multiple bits are 1, display the message for the lowest order bit.

If all bits in the device are 0 or if a bit with no associated message becomes 1, display nothing.

Value: Switches the message to display according to the value of device.

Example: When **Value** is selected and the value of **Trigger Device D0** are allocated to the following messages.

Message details

Trigger Device D0 value	0 : Msg0	Drying
	1 : Msg1	Heating
	2 : Msg2	Cooling

Switches the message to display according to the value of device.

Trigger Device D0 value	0	1	2	3
Message to display	Drying Msg0	Heating Msg1	Cooling Msg2	
Action	Display Msg0	Display Msg1	Display Msg2	No message

If the value of device has no message associated with it, display nothing.

■ Trigger Device

Specifies the word device to use as the condition for switching messages.

Click to display the Device Address Settings dialog box. For the device address configuration procedure, refer to Chapter 2 "5.1 Device Address Settings" on page 2-61.

● Message Tab

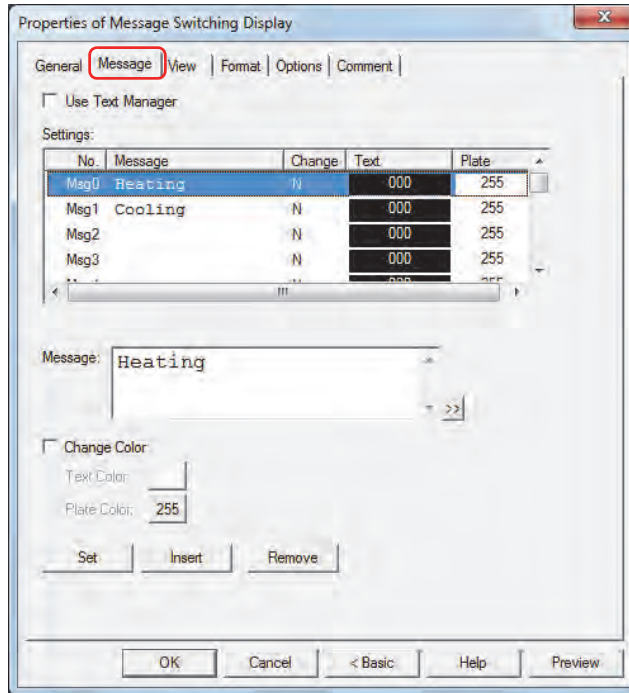

■ Use Text Manager

Select this check box to use text registered in Text Manager.

■ Settings

Lists the message settings.

- No.: Shows the message number (Msg number).
The number of messages that can be registered varies based on **Switching Method** on the **General** tab.
- Bit: Msg0 to Msg15
Value: Msg0 to Msg999
- Message: Shows the registered message.
- Change: Shows **Y** when the **Change Color** check box is selected. Shows **N** when the check box is cleared.
- Text: Shows the text color of the message.
- Plate: Shows the plate color.

■ Text ID

Specifies the Text Manager ID number (1 to 32000) when using text registered in Text Manager.

Click  to display Text Manager.

This option can only be configured when the **Use Text Manager** check box is selected.

■ Message

Enter the text to display. The maximum number is 3,750 characters. You can enter multi-line messages by inserting a newline.

The characters that can be entered vary based on the font selected for **Font** on the **Format** tab. For details, refer to Chapter 2 "1.2 Available Text" on page 2-5.

This option can only be configured if the **Use Text Manager** check box is cleared.



- To enter Unicode characters, click  to display the Unicode Input dialog box. Enter the characters in the Unicode Input dialog box, and then click **OK**.
- To display the backslash (\), enter a backslash (\) before the backslash (\).
Example: \\

■ Change Color

Select this check box to configure **Text Color** and **Plate Color** per Msg number.

Text Color: Selects the text color for the messages when configuring the text color per Msg number (color: 256 colors, monochrome: 8 shades).

Click this button to display the Color Palette. Select a color from the Color Palette.

Plate Color: Selects the plate color for the messages when configuring the plate color per Msg number (color: 256 colors, monochrome: 8 shades).

Click this button to display the Color Palette. Select a color from the Color Palette.

When this check box is cleared, the colors are configured by **Text Color** on the **Format** tab and **Plate Color** on the **View** tab.

■ Set

Registers the message and color settings to the list. If you select a Msg number that is already registered, that number is overwritten with the new settings.

Select a Msg number on the list, and then click this button to register the **Message** and **Change Color** settings.

■ Insert

Inserts the message and color settings in the position selected on the list.

Select a Msg number on the list, and then click this button to insert the **Message** and **Change Color** settings. The settings at the insertion point shift down one line. Settings cannot be inserted if all Msg numbers are configured.

■ Remove

Deletes the registered settings from the list.

Select a Msg number, and then click this button to delete the selected settings from the list.

● View Tab

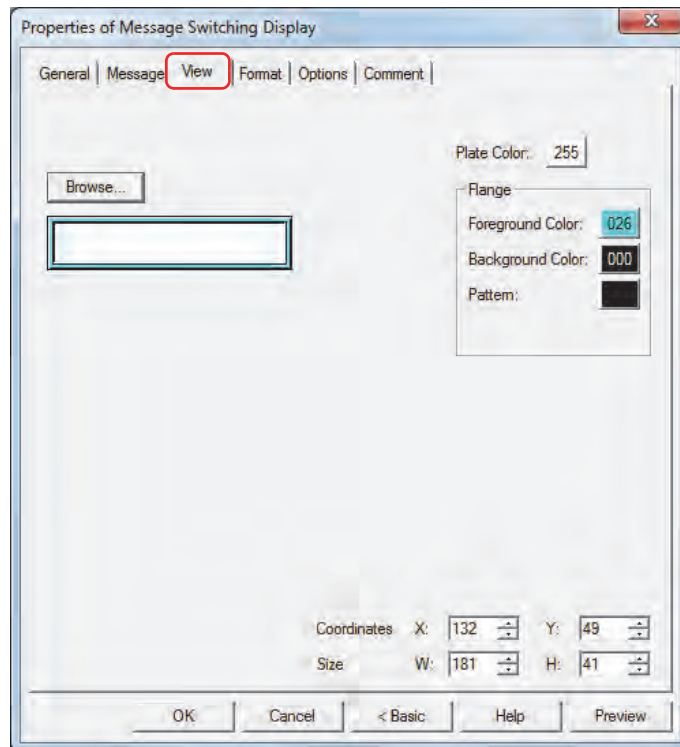

■ Browse

Select the type of graphic to represent the part from the list of graphics. Click this button to display the View Browser.

■ Plate Color

Selects the plate color of the standard graphic (color: 256 colors, monochrome: 8 shades).

Click the **Color** button to display the Color Palette. Select a color from the Color Palette.

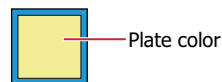

■ Flange

Foreground Color, Background Color:

Selects the foreground and background colors of the flange of the standard graphic (color: 256 colors, monochrome: 8 shades).

Click the **Color** button to display the Color Palette. Select a color from the Color Palette.

Pattern:

Selects a pattern for the flange of the standard graphic.

Click the **Pattern** button to display the Pattern Palette. Select a pattern from the Pattern Palette.

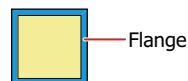

■ Coordinates

- X, Y: Sets the display position of parts using coordinates.
The X and Y coordinates of parts is defined relative to an origin at the top-left corner of the screen.
- X: 0 to (Base Screen horizontal size - 1)
- Y: 0 to (Base Screen vertical size - 1)

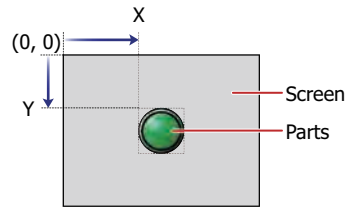

■ Size

- W, H: Sets width and height to define the size of parts.
- W: 5 to (Base Screen horizontal size)
- H: 5 to (Base Screen vertical size)

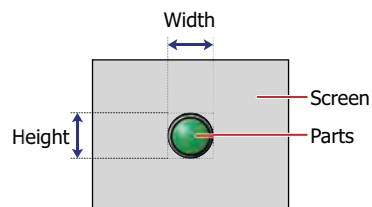

● Format Tab

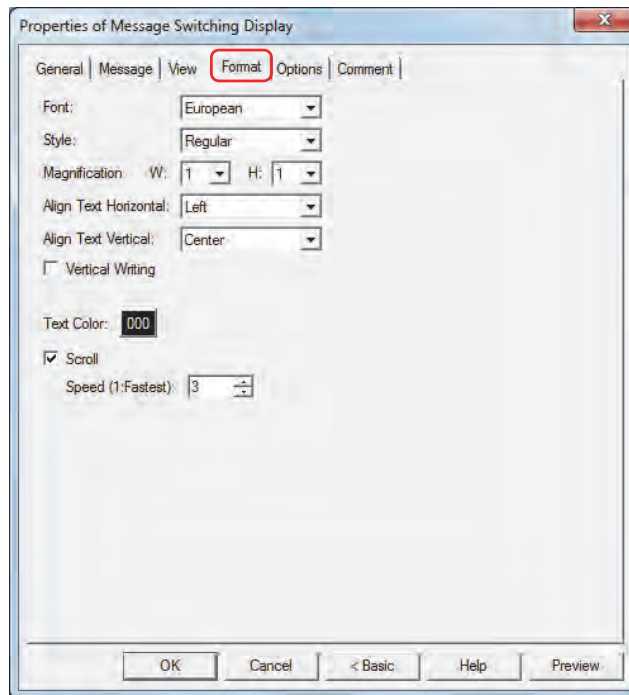

■ Font

Selects the font for displaying text from the following.

Japanese, European, Chinese, Taiwanese, Korean, Central European, Baltic, Cyrillic

The characters that can be displayed depend on the font. For details, refer to Chapter 2 “1.2 Available Text” on page 2-5.

■ Style

Selects **Regular** or **Bold** for text style.

■ Magnification

W, H: Selects text magnification (0.5, 1 to 8).

■ Align Text Horizontal

Selects the text alignment in the horizontal direction from the following.

Left, Center, Right

For details, refer to Appendix “5 Text Alignment” on page A-5.

■ Align Text Vertical

Selects the text alignment in the vertical direction from the following.

Top, Center, Bottom, Center-Top

Set to **Center** when the **Vertical Writing** check box is selected.

For details, refer to Appendix “5 Text Alignment” on page A-5.

■ Vertical Writing

Select this check box when displaying text vertically.



When the **Vertical Writing** check box is selected, take care about the following points. This is applicable for Windows supports East Asian characters.

- When there is a mixture of double-byte and single-byte characters, the half-width characters are left-aligned.

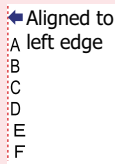

- Dashes are displayed horizontally. Symbols representing voiced and semi-voiced sounds of single-byte characters are shown as follows.

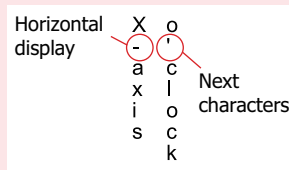

■ Text Color

Selects the color of displayed text (color: 256 colors, monochrome: 8 shades).

Click the **Color** button to display the Color Palette. Select a color from the Color Palette.

■ Scroll*1

Select this check box to enable scrolling display displaying of messages.

Speed (1: Fastest): Sets the scrolling speed (1 to 10). 1 is fastest, 10 is slowest.



When the **Scroll** check box is selected operation is follows.

- Messages that include CRs are displayed without the CRs.
- Messages scroll in the direction in which the text is drawn.
- When the message is switched, the message is scrolled from the beginning.



When the **Scroll** check box is selected, take care about the following points.

- The number of parts that can be arranged on a single screen decreases. If the Touch displays an error message, clear the **Scroll** check box, or reduce the number of parts on the screen.
- When the scan time of the Touch is long, scrolling speed may become slow.

*1 Advanced mode only

● Options Tab

The **Options** tab is displayed in Advanced mode.

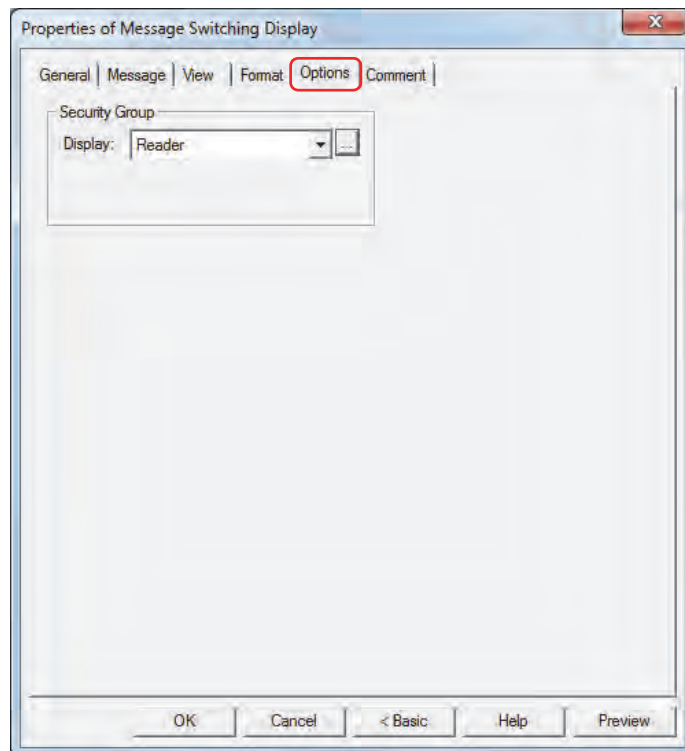

■ Security Group

Security groups are a security function for restricting the display and operation of parts.

Display: Selects the security group for which display of parts is restricted. (Default: None)

None: No security function is used.



Administrator, Operator, Reader: Three security groups are set up by default.

Click  to display the Security Group Settings dialog box. If you create a security group on the Security Group Settings dialog box, you can select that created group. For details, refer to Chapter 21 "2.2 Adding and Editing Security Groups" on page 21-15.



For details about security functions, refer to Chapter 21 "User Accounts and the Security Function" on page 21-1.

Example: If the user and security group for a part are set as follows:

User Name	 User1	 User2
Security Group	None	Group A

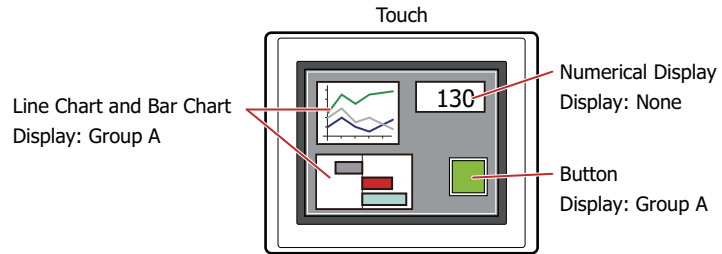

For User 1, who is not included in the specified security group, Group A parts are not displayed.

If the Password Screen is now opened and a switch is made to User 2 of Group A, Group A parts are displayed.

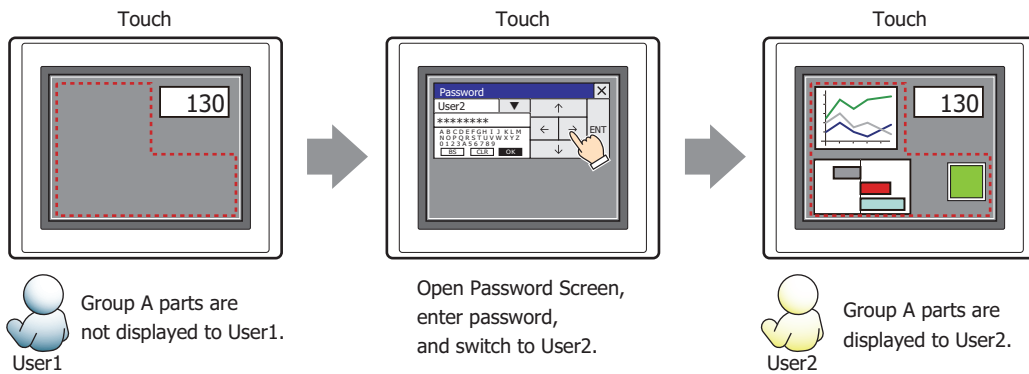

● Comment Tab

The **Comment** tab is used to specify the parts arranged on the editing screen, and the popup text displayed when the mouse pointer is placed close to **No.**, **Name**, or **Type** in the object list.



When there are multiple parts of the same shape on the screen, this feature makes it possible to distinguish between the parts without displaying the Properties dialog box for each part, by just mousing over the part.

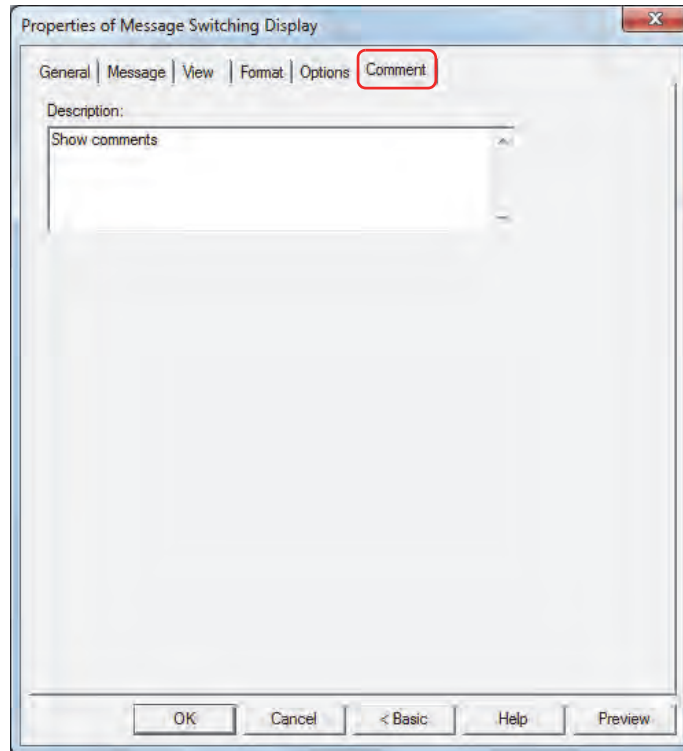

■ Description

Enter a comment about parts. The maximum number is 80 characters.

Example: When mousing over the Message Switching Display on the editing screen

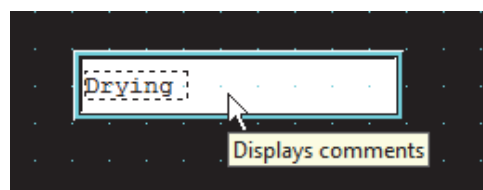

6 Alarm List Display

6.1 How the Alarm List Display is Used

The Alarm List Display works with the Alarm Log function to display messages for active alarms and to display multiple messages according to values of devices in a list.

- List currently active alarms out of the alarms configured in the Alarm Log settings

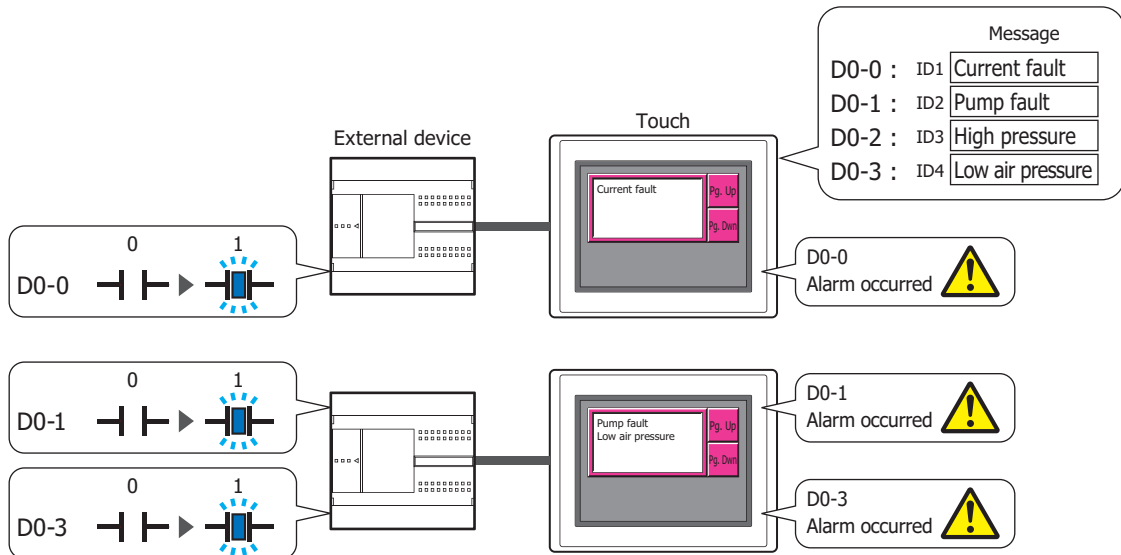

- Display multiple messages according to values of devices

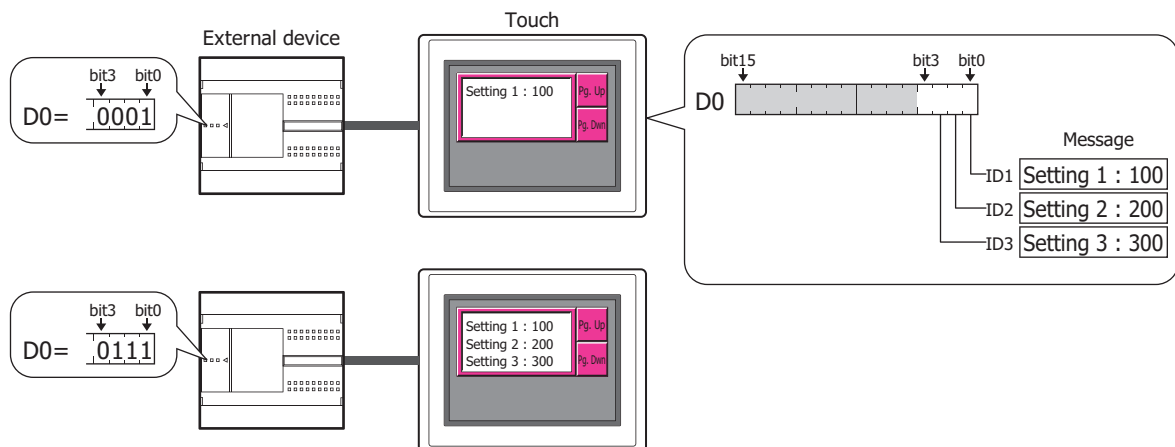

- Only one Alarm List Display or Alarm Log Display can be configured on a single screen.
- When the active alarm is displayed on the Alarm List Display, the message disappears from the list when the alarm is recovered from regardless of the **Lock/Unlock** setting. To display the alarm message until it can be checked, use the Alarm Log Display. **Lock/Unlock** is configured on the **Channel** tab in the Alarm Log Settings dialog box.



- For the key buttons used with the Alarm List Display, refer to Chapter 7 "Alarm List Display" on page 7-65.
- The number of the message (channel when using the Alarm function) that has focus on the Alarm List Display is stored in HMI Special Data Register LSD50.
- The information about where on the list the message that has focus is displayed, out of all the messages displayed on the Alarm List Display, is stored in HMI Special Data Register LSD56.

6.2 Alarm List Display Configuration Procedure

This section describes the configuration procedure for Alarm List Display.

- 1 On the **Home** tab, in the **Parts** group, click **Data Displays**, and then click **Alarm List Display**.

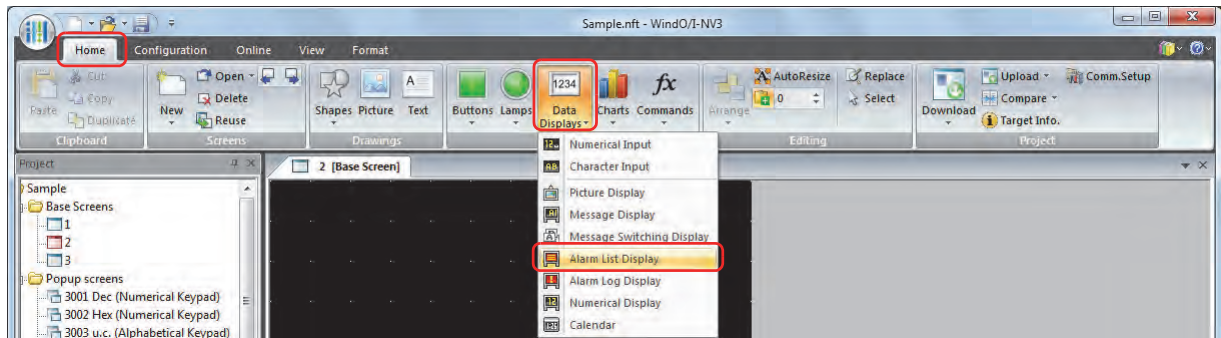

- 2 Click a point on the edit screen where you want to place the Alarm List Display.
- 3 Double-click the dropped Alarm List Display and a Properties dialog box will be displayed.
- 4 Change the settings on each tab as necessary.

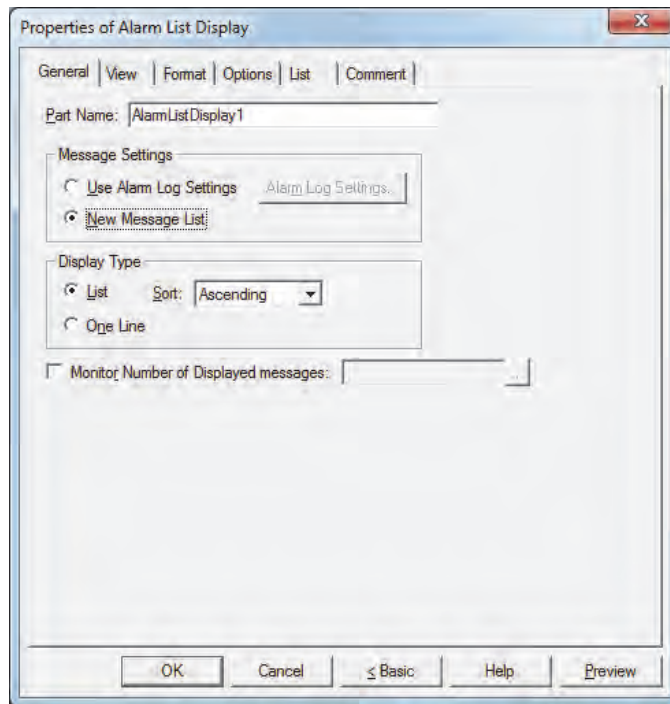

The **Options** tab only appears in Advanced mode.
To switch to Advanced mode, click **Advanced**.

6.3 Properties of Alarm List Display Dialog Box

This section describes items and buttons on the properties dialog box.

● General Tab

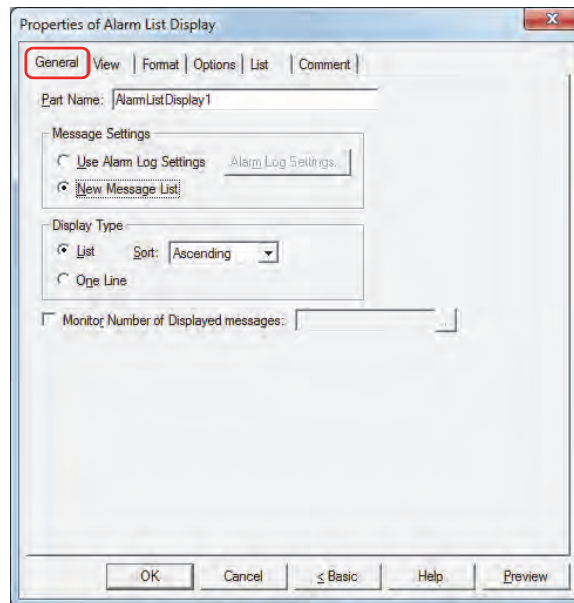

■ Part Name

Enter a name for the part. The maximum number is 20 characters.

■ Message Settings

Selects the method for switching message to display.

Use Alarm Log Settings: Displays messages for the active alarms. The alarms are configured by the Alarm Log settings.

Alarm Log Settings: Displays the Alarm Log Settings dialog box.

New Message List: Displays the messages registered in Text Manager according to the state of bits in the trigger device configured on the **List** tab.

Example: When **Use Alarm Log Settings** is selected, the **Source** (device to monitor) configured by the Alarm Log function is D0, and the following messages are allocated to the channels

	Message
Source D0-0 : ID1	Current fault
D0-1 : ID2	Pump fault
D0-2 : ID3	High pressure
D0-3 : ID4	Low air pressure

The active alarm messages are displayed.

	D0-0	1	0	1	1	0
Source bit state	D0-1	0	1	0	1	0
	D0-2	0	1	1	1	0
	D0-3	0	0	1	1	0
Message to display		Current fault Pg. Up Pg. Dwn	Pump fault High pressure Pg. Up Pg. Dwn	Current fault High pressure Low air pressure Pg. Up Pg. Dwn	Current fault Pump fault High pressure Low air pressure Pg. Up Pg. Dwn	
Action		Display ID1	Display ID2, ID3	Display ID1, ID3, ID4	Display ID1, ID2, ID3, ID4	No message

If all bits in the device are 0 or if a bit with no associated message becomes 1, display nothing.

Example: When **New Message List** is selected and the bits of **Trigger Device D0** are allocated to the following messages.

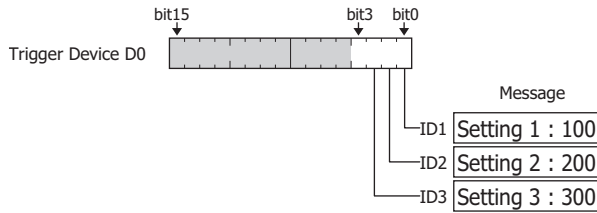

The messages are displayed according to the state of the bits.

Trigger Device D0 bit state	0001	0110	0101	0111	0000
Message to display					
Action	Display ID1	Display ID2, ID3	Display ID1, ID3	Display ID1, ID2, ID3	No message

If all bits in the device are 0 or if a bit with no associated message becomes 1, display nothing.

Display Type

Selects whether or not to simultaneously display multiple messages.

List: Simultaneously displays multiple messages.

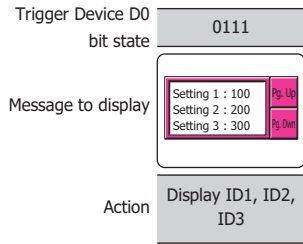

Sort: Selects the display order when displaying multiple messages.

Old and **New** can only be configured when the **Use Alarm Log Settings** check box is selected.

Ascending: Sorts the list in alphabetic order from A to Z.

Descending: Sorts the list in alphabetic order from Z to A.

Old: Sorts the list in order from oldest to newest.

New: Sorts the list in order from newest to oldest.

One Line: Displays only a single message.

When multiple bits are 1, the message for the lowest order bit is displayed.

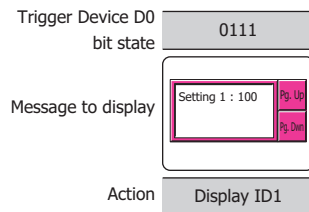

Monitor Number of Displayed messages

Select this check box to count the number of displayed messages.

This option can only be configured when the **New Message List** check box is selected.

(Destination device): Specifies the word device to write the number of displayed messages to.

Click to display the Device Address Settings dialog box. For the device address configuration procedure, refer to Chapter 2 "5.1 Device Address Settings" on page 2-61.

● List Tab

The **List** tab is only displayed when **New Message List** is selected for **Message Settings** on the **General** tab.

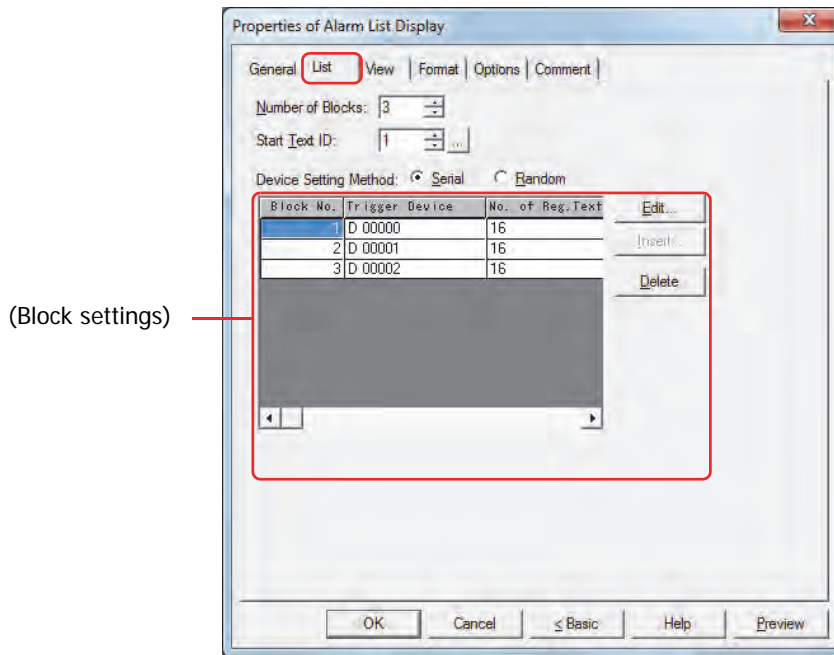

■ Number of Blocks

Configures the devices that trigger messages to display and message switching as blocks (0 to 64).



1 block is composed of 16 channels. 1 device bit can be monitored for each channel. The maximum number of device bits that can be monitored is 16 for each block.

■ Start Text ID

Specifies the Text Manager ID number (1 to 32000) of the message to display. The text ID numbers are sequentially configured for all channels from the first block starting with the ID number configured here. Click to display Text Manager.

■ Device Setting Method

Selects the trigger device setting method.

Serial: The trigger devices after the block number selected in the block settings are configured with sequential addresses.

Random: Configures trigger devices for each block number.

■ (Block settings)

Registers and edits the messages to display for each block channel.

Block No.: Shows the block numbers in the amount specified by **Number of Blocks**. Double clicking the cell displays the Individual Settings dialog box. For details, refer to "Individual Settings Dialog Box" on page 9-88.

Trigger Device: Shows the word device to use as the condition to display messages. Double clicking the cell displays the Device Address Settings dialog box. For the device address configuration procedure, refer to Chapter 2 "5.1 Device Address Settings" on page 2-61. When **Serial** is selected for **Device Setting Method**, the trigger devices for block numbers after the selected block number are automatically configured with the configured trigger device as the starting address.

No. of Reg. Text: Shows the number of messages registered to the block. Double clicking the cell displays the Individual Settings dialog box. For details, refer to "Individual Settings Dialog Box" on page 9-88.

Edit: Changes the block settings in list. Select a block number in the list, and then click this button to display the Individual Settings dialog box. For details, refer to "Individual Settings Dialog Box" on page 9-88.

- Insert:** Inserts the block settings in the position selected on the list. Select the block number at the position to insert the settings in the list, and then click this button to display the Individual Settings dialog box. For details, refer to "Individual Settings Dialog Box" on page 9-88. The settings at the insertion point shift down one line. Settings cannot be inserted if all block numbers are configured.
- Delete:** Deletes the registered settings from the list. Select a block number on the list, and then click this button to delete the selected settings from the list.

Individual Settings Dialog Box

The Individual Settings dialog box is used to configure the conditions to display the messages.

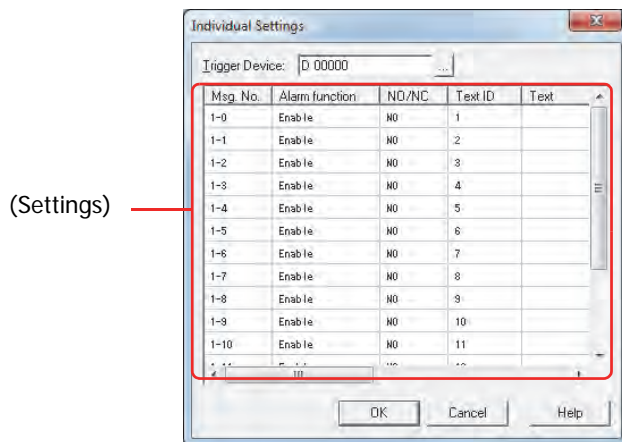

■ **Trigger Device**

Specifies the word device to use as the condition to display messages. The bit of the word device corresponds to the message numbers.

Example: When the number of blocks is 1 and D0 is specified as the trigger device

Message number 1-0 device bit is D0-0, message number 1-1 device bit is D0-1, up to message number 1-15 device bit which is D0-15.

Msg. No.	Device bit
1-0	D0-0
1-1	D0-1
1-2	D0-2
⋮	⋮
1-14	D0-14
1-15	D0-15

Block 1
16 channels

Click to display the Device Address Settings dialog box. For the device address configuration procedure, refer to Chapter 2 "5.1 Device Address Settings" on page 2-61.

When **Serial** is selected for **Device Setting Method** on the **List** tab, the trigger devices for block numbers after the block number being registered or edited are automatically changed with the configured trigger device as the starting address.

■ **(Settings)**

- Msg. No.:** Displayed as (Block No.)-(Message No.).
- Alarm function:** Selects whether or not to use the alarm function. Double clicking the cell switches between **Enable** and **Disable**.

 - Enable: Monitors the state of the device bit configured for the channel and displays the message.
 - Disable: The device bit is not monitored and the message is not displayed.
- NO/NC:** Selects the alarm detection condition. Double clicking the cell switches between **NO** and **NC**.

 - NO: Displays the message when the monitored bit changes from 0 to 1.
 - NC: Displays the message when the monitored bit changes from 1 to 0.
- Text ID:** Shows the Text Manager ID number (1 to 32000) to use for the message. The text ID is sequentially configured starting with the text ID configured by **Start Text ID** on the **List** tab.
- Text:** Shows the text for the specified text ID. Only shows the first line of text when the text registered to the text ID has multiple lines.

● View Tab

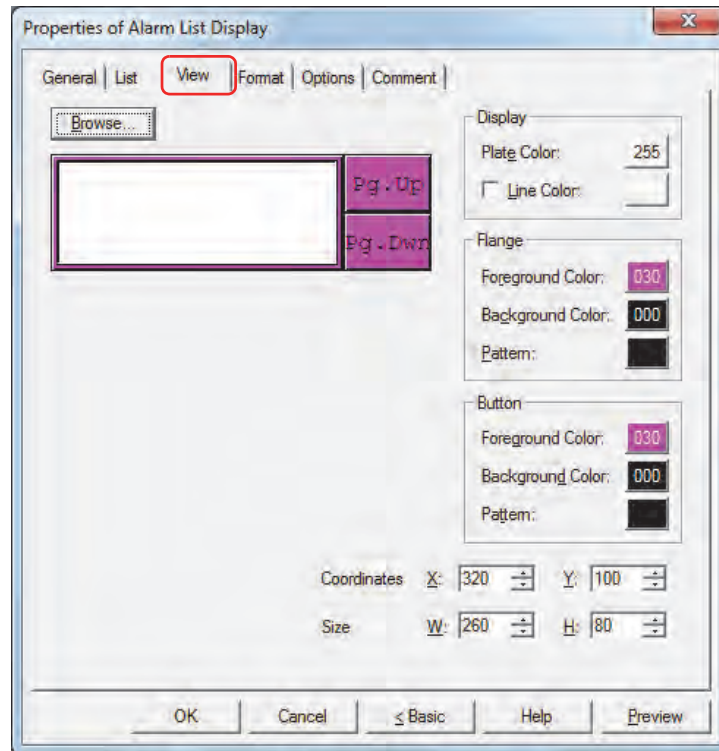

■ Browse

Select the type of graphic to represent the part from the list of graphics. Click this button to display the View Browser.

■ Plate Color

Selects the plate (color: 256 colors, monochrome: 8 shades).

Click the **Color** button to display the Color Palette. Select a color from the Color Palette.

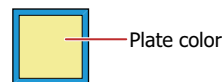

■ Line Color

When lines are displayed, select the check box and select line color (color: 256 colors, monochrome: 8 shades).

Click the **Color** button to display the Color Palette. Select a color from the Color Palette.



■ Flange

Foreground Color, Background Color:

Selects the foreground and background colors of the flange (color: 256 colors, monochrome: 8 shades).

Click the **Color** button to display the Color Palette. Select a color from the Color Palette.

Pattern:

Selects a pattern for the flange.

Click the **Pattern** button to display the Pattern Palette. Select a pattern from the Pattern Palette.



■ Buttons

Foreground Color, Background Color: Selects the foreground and background colors of the buttons (color: 256 colors, monochrome: 8 shades).

Click the **Color** button to display the Color Palette. Select a color from the Color Palette.

Pattern:

Selects a pattern for the button.

Click the **Pattern** button to display the Pattern Palette. Select a pattern from the Pattern Palette.

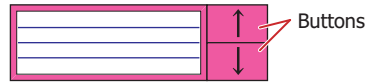

Can be set only when there are grouped Key Buttons.

■ Coordinates

X, Y: Sets the display position of parts using coordinates.

The X and Y coordinates of parts is defined relative to an origin at the top-left corner of the screen.

X: 0 to (Base Screen horizontal size - 1)

Y: 0 to (Base Screen vertical size - 1)

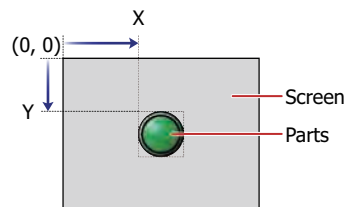

■ Size

W, H: Sets width and height to define the size of parts.

W: 20 to (Base Screen horizontal size)

H: 20 to (Base Screen vertical size)

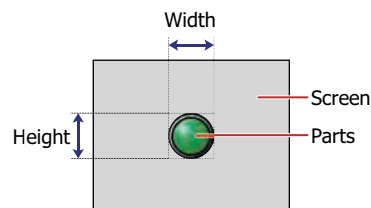

● Format Tab

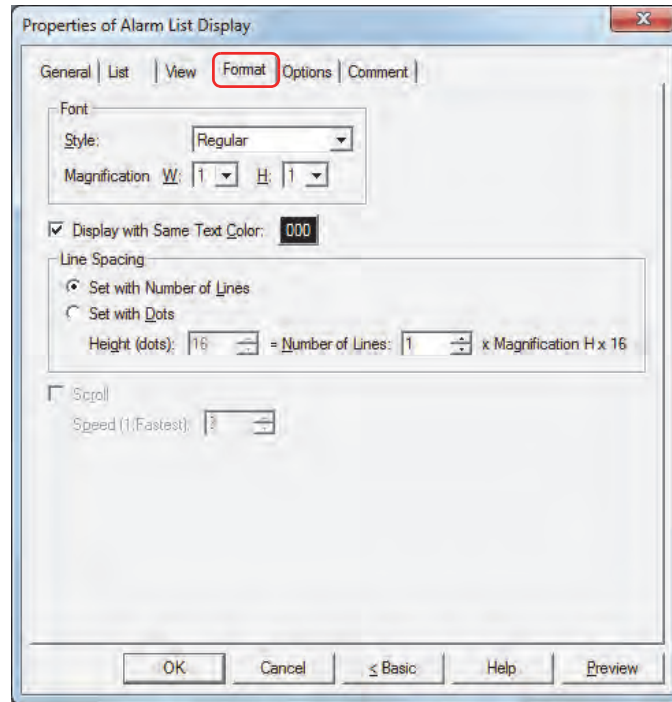

■ Style

Selects **Regular** or **Bold** for text style.

■ Magnification

W, H: Selects text magnification (0.5, 1 to 8).

■ Display with Same Text Color

To set the text color for all messages to the same color, select this check box and select the text color to display (color: 256 colors, monochrome: 8 shades).

Click this button to display the Color Palette. Select a color from the Color Palette.

When this check box is cleared, the color for messages is the text color configured in Text Manager.

■ **Line Spacing** *1

Selects the specification method for line spacing in the list and configures the line spacing.

Set with Number of Lines:

Specifies the number of lines for the message to display for one alarm line.

Number of Lines: Enter the number of lines (1 to 10). To completely display a message that contains newlines, a number of lines that is equal to or greater than the number of message lines is required.

When you enter a value in **Number of Lines**, **Height (dots)** is automatically calculated according to the display area.

The relationship between the number of lines and the height (dots) is height (dots) = number of lines x magnification H x 16.

Number of Lines	Magnification H	Height	
1	1	16 dots	
2	1	32 dots	
3	1	48 dots	



Since the alarm line spacing is adjusted with the number of lines for the message fixed, this option is convenient to use when displaying multi-line messages.

Set with Dots: Specifies the line spacing for the message to display for one alarm line in dots.

Height (dots): Enter the height (8 to 160). To completely display a message, a height equal to or greater than **Magnification H** x 16 dots x the number of message lines is required.

When **Magnification H** is 1

To display a one-line message, 1 x 16 = 16 dots, a height of 16 dots or higher is required.

Height 16 dots

To display a two-line message, 2 x 16 = 32 dots, a height of 32 dots or higher is required.

Height 32 dots

Height 16 dots

When **Magnification H** is 2

To display a one-line message, 1 x 32 = 32 dots, a height of 32 dots or higher is required.

Height 32 dots

To display a two-line message, 2 x 32 = 64 dots, a height of 64 dots or higher is required.

Height 64 dots

Height 32 dots

*1 Advanced mode only

■ Scroll*1

Select this check box to enable scrolling display displaying of messages.

Can only be set when **One Line** is selected for **Display Type** under the **General** tab.

Speed (1: Fastest): Sets the scrolling speed (1 to 10). 1 is fastest, 10 is slowest.



When the **Scroll** check box is selected operation is follows.

- Messages that include CRs are displayed without the CRs.
- Messages scroll in the direction in which the text is drawn.
- When the text displayed according to values of devices, the text color, the displayed text, or the alarm state changes, the message is scrolled from the beginning.



When the **Scroll** check box is selected, take care about the following points.

- The number of parts that can be arranged on a single screen decreases. If the Touch displays an error message, clear the **Scroll** check box, or reduce the number of parts on the screen.
- When the scan time of the Touch is long, scrolling speed may become slow.

*1 Advanced mode only

● Options Tab

The **Options** tab is displayed in Advanced mode.

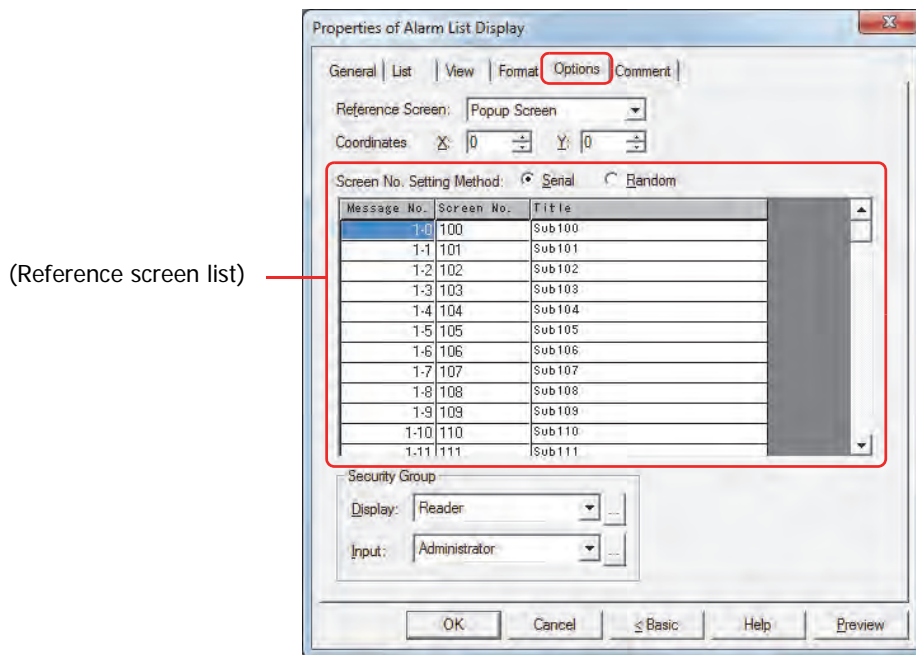

■ Reference Screen

The **Options** tab is used to configure the reference screen. The reference screen is a Base Screen or Popup Screen associated with each individual message. The reference screen is displayed when the key button **Ref.** is pressed.

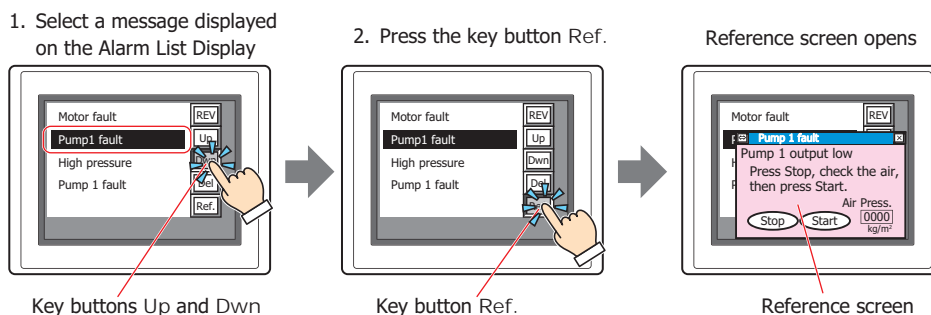

When displaying a reference screen, select either **Base Screen** or **Popup Screen** as the reference screen type. When not displaying a reference, select **Not Use**.

This can only be set when **New Message List** has been selected in **Message Settings** on the **General** tab. When **Use Alarm Log Settings** has been selected, the screen type will become the one selected in **Reference Screen** on the **Channel** tab in the Alarm Log Settings dialog box.

■ Coordinates

X, Y: Specifies the coordinates to display the reference screen.

With the upper-left corner of the screen as the origin, the X and Y coordinates are the upper-left corner of the reference screen.

This option can only be configured when **Base Screen** or **Popup Screen** is selected for **Reference Screen**.

Specify the coordinates in 1 dot units.

X: 0 to (Base Screen horizontal size - 1)

Y: 0 to (Base Screen vertical size - 1)

■ Screen No. Setting Method

Selects the setting method for the screen numbers on the reference screen list.

Serial: Continuously and automatically specifies screen numbers (1 to 3000) that are at or below the selected message number.

Example 1: When screen number "100" has been entered for message number 1-0.

Message No.	Screen No.
1-0	
1-1	
1-2	
1-3	
1-4	
1-5	
1-6	
1-7	
1-8	
1-9	
1-10	



Message No.	Screen No.
1-0	100
1-1	101
1-2	102
1-3	103
1-4	104
1-5	105
1-6	106
1-7	107
1-8	108
1-9	109
1-10	110

Screen numbers "100", "101", "102"....are automatically specified in order from message number 1-0.

Example 2: When screen number "200" has been entered for message number 1-5.

Message No.	Screen No.
1-0	100
1-1	101
1-2	102
1-3	103
1-4	104
1-5	105
1-6	106
1-7	107
1-8	108
1-9	109
1-10	110



Message No.	Screen No.
1-0	100
1-1	101
1-2	102
1-3	103
1-4	104
1-5	200
1-6	201
1-7	202
1-8	203
1-9	204
1-10	205

Message numbers 1-0 to 1-4 are left unchanged and screen numbers "200", "201", "202"....are automatically specified in order from message number 1-5.

Random: Specifies a reference screen number (1 to 3000) for each message number.

■ (Reference Screen List)

Displays a list reference screen numbers and screen titles that have been set to messages.

Message No.: Displays the message number.

Screen No.: Displays the reference screen number.
The screen number can be set according to the **Screen No. Setting Method**. The screen number is specified in the screen number input dialog box that appears after double clicking on a cell. Enter a screen number (1 to 3000) into **Screen No.** and then click **OK**.

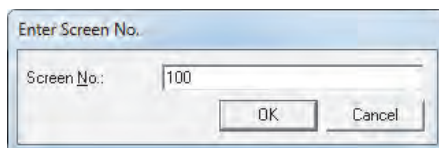

When there is not screen for the specified screen number a message confirming the creation of a new screen will appear.

If **Yes** is clicked, a screen will be created. If **No** is clicked, creating a screen is cancelled.

Title: Displays the title of a reference screen.
When editing a title, editing is performed in the Enter Title dialog box that appears after double clicking on a cell. Edit the title and then click **OK**. The maximum number is 40 characters.

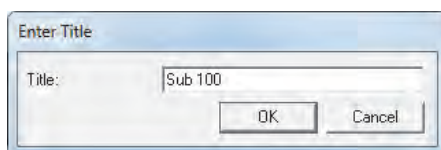

The title can be edited only when the screen number has already been set.

Security Group

Security groups are a security function for restricting the display and operation of parts.

Display: Selects the security group for which display of parts is restricted. (Default: None)

None: No security function is used.

Administrator, Operator, Reader: Three security groups are set up by default.

Click  to display the Security Group Settings dialog box. If you create a security group on the Security Group Settings dialog box, you can select that created group. For details, refer to Chapter 21 "2.2 Adding and Editing Security Groups" on page 21-15.

Input: Selects the security group for which operation of parts is restricted. (Default: None)

None: No security function is used.



Administrator, Operator, Reader: Three security groups are set up by default.

Click  to display the Security Group Settings dialog box. If you create a security group on the Security Group Settings dialog box, you can select that created group. For details, refer to Chapter 21 "2.2 Adding and Editing Security Groups" on page 21-15.



- The security group for input can only be configured when there are grouped key buttons.
- For details about security functions, refer to Chapter 21 "User Accounts and the Security Function" on page 21-1.

Example: If the user and security group for a part are set as follows:

User Name	 User1	 User2	 User3
Security Group	None	Group A	Group A, Group B

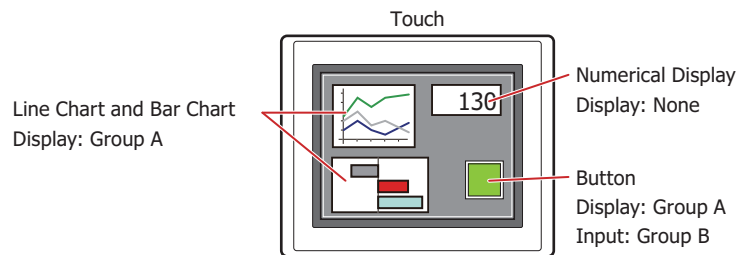

For User 1, who is not included in the specified security group, Group A parts are not displayed.

If the Password Screen is now opened and a switch is made to User 2 of Group A, Group A parts are displayed.

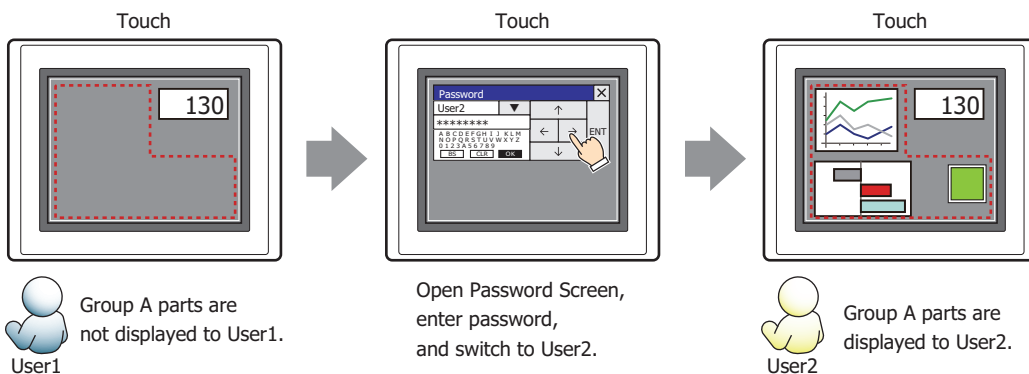

Since the display security group is Group A, User 2 (of Group A) can view the buttons. But since the input security group is Group B, User 2 cannot operate the buttons.

Suppose that the Password Screen is now opened and a switch is made to User 3, who is part of both Group A and Group B. Group A buttons can be displayed, and Group B buttons can be operated.

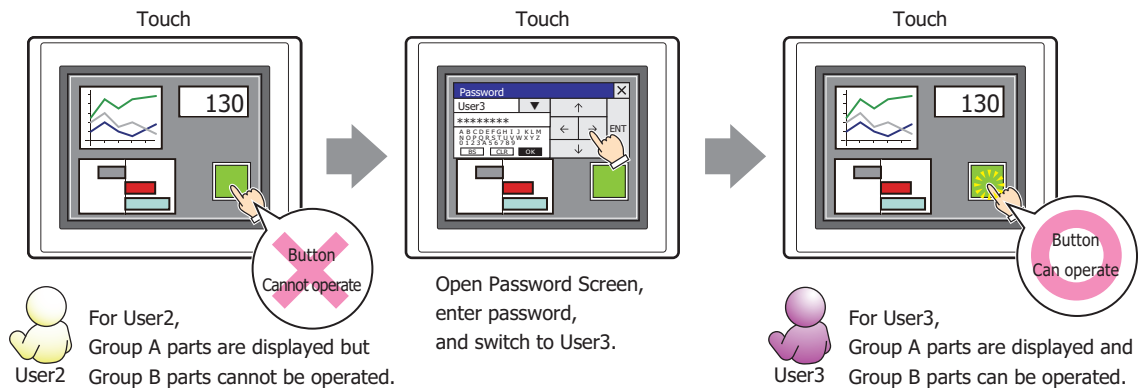

● Comment Tab

The **Comment** tab is used to specify the parts arranged on the editing screen, and the popup text displayed when the mouse pointer is placed close to **No.**, **Name**, or **Type** in the object list.



When there are multiple parts of the same shape on the screen, this feature makes it possible to distinguish between the parts without displaying the Properties dialog box for each part, by just mousing over the part.

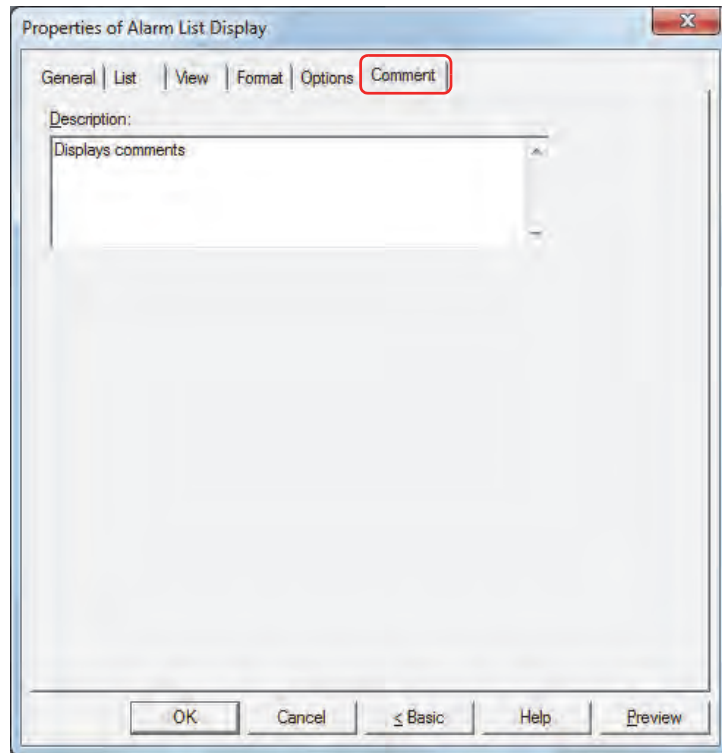

■ Description

Enter a comment about parts. The maximum number is 80 characters.

Example: When mousing over the Alarm List Display on the editing screen

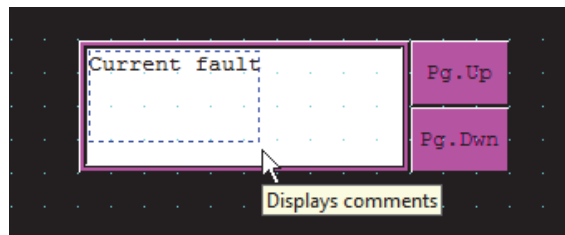

7 Alarm Log Display

7.1 How the Alarm Log Display is Used

The Alarm Log Display displays Alarm Log data saved in the data storage area.

- List the message, the occurrence time, recovery time, and confirmation time for the alarms that have occurred

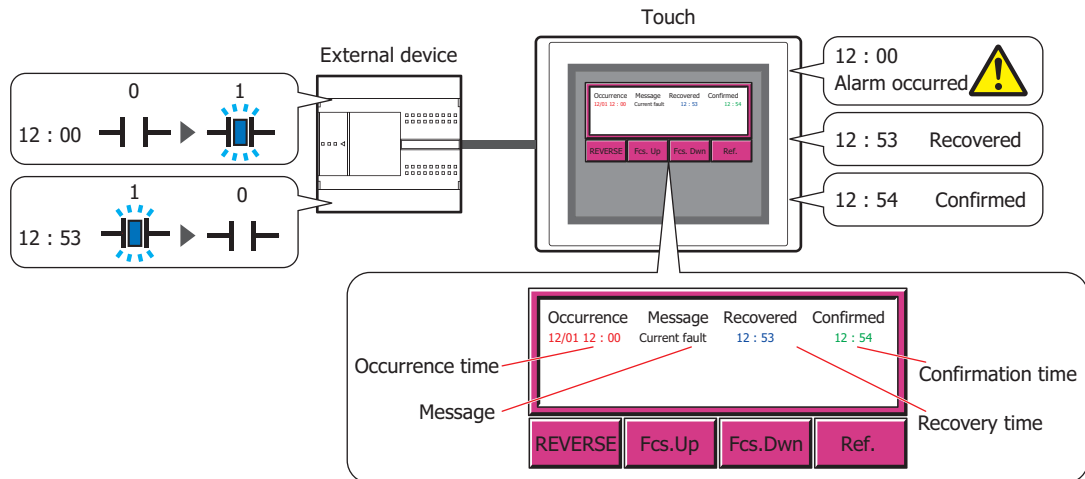

- Display the reference screen for alarms that have occurred

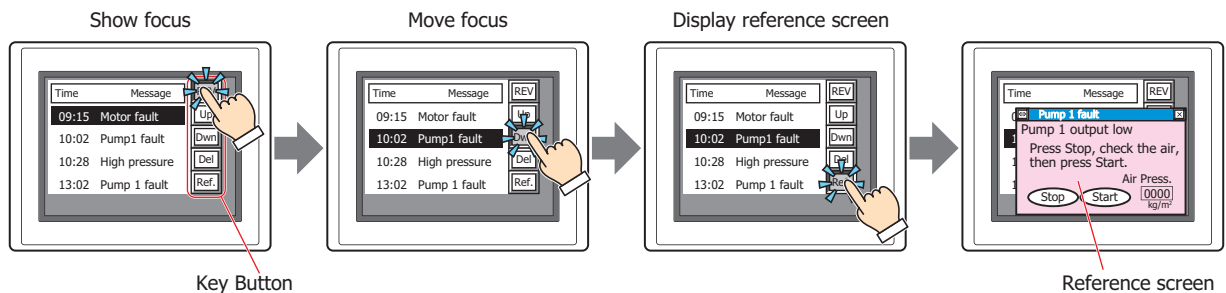

Only one Alarm List Display or Alarm Log Display can be configured on a single screen.



- For the key buttons used with the Alarm Log Display, refer to Chapter 7 "Alarm Log Display" on page 7-65.
- When the **Operate the Alarm on List directly** check box on the **General** tab in the Properties of Alarm Log Display dialog box is selected, a displayed alarm can be given focus by pressing it on the list.
- The number of lines from the start line to the selected line of the message displayed on the Alarm Log Display is stored in HMI Special Data Register LSD56.

7.2 Alarm Log Display Configuration Procedure

This section describes the configuration procedure for Alarm Log Display.

- 1 On the **Home** tab, in the **Parts** group, click **Data Displays**, and then click **Alarm Log Display**.

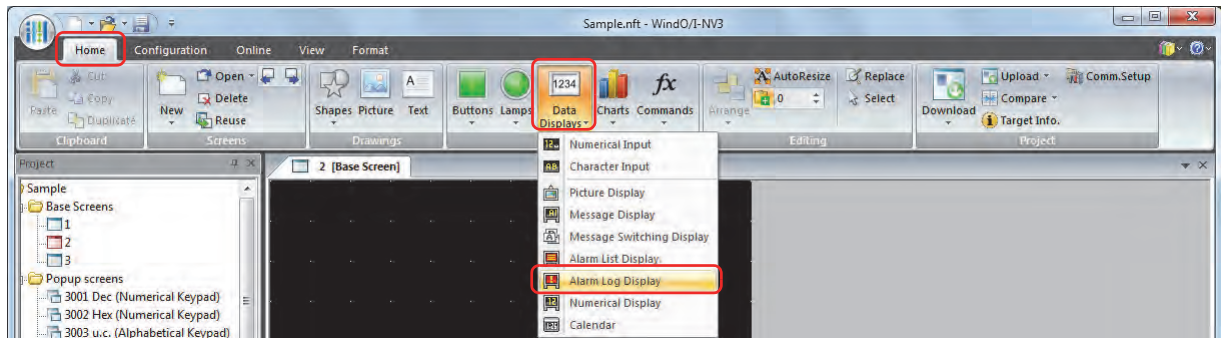

- 2 Click a point on the edit screen where you want to place the Alarm Log Display.
- 3 Double-click the dropped Alarm Log Display and a Properties dialog box will be displayed.
- 4 Change the settings on each tab as necessary.

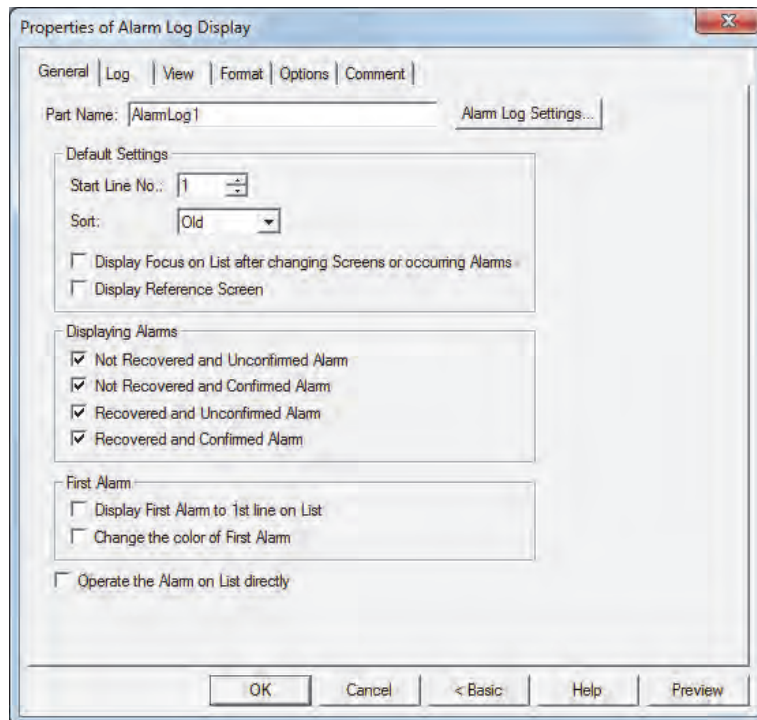

The **Options** tab only appears in Advanced mode.
To switch to Advanced mode, click **Advanced**.

7.3 Properties of Alarm Log Display Dialog Box

This section describes items and buttons on the properties dialog box.

● General Tab

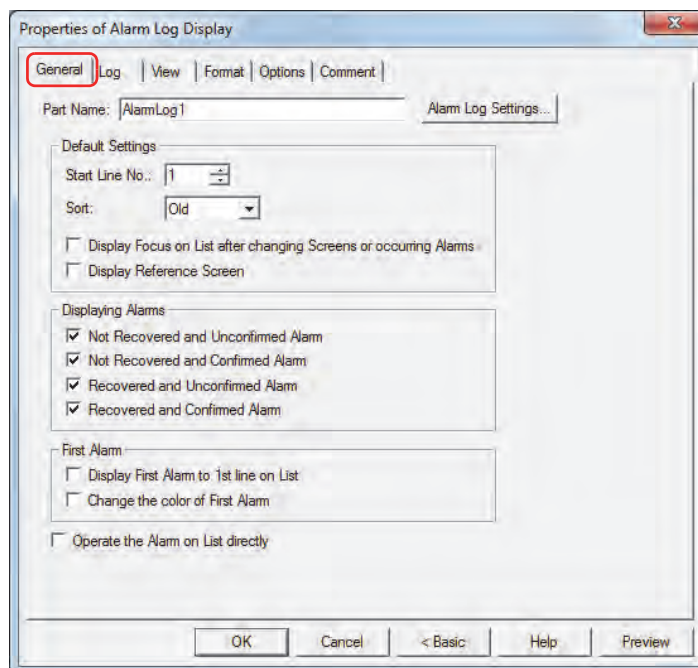

■ Part Name

Enter a name for the part. The maximum number is 20 characters.

■ Default Settings

These options configure the default settings when the Alarm Log Display is displayed.

Start Line No.: Specifies what number alarm to display when multiple alarms have occurred. The range that can be specified is 1 to 5,011.

Sort: Selects the display order for alarms that have occurred as **Old** or **New**.

Display Focus on List after changing Screens or occurring Alarms^{*1}: Select this check box to automatically display the focus at the first item in the list after switching screens and when an alarm occurs.

Display Reference Screen^{*1}: Select this check box to automatically display the reference screen for the alarm that has focus under the following conditions.
When the focus is displayed
When the focus moves
When a new alarm occurs

■ Displaying Alarms^{*1}

Select these check boxes for alarms to display on the Alarm Log Display.

Not Recovered and Unconfirmed Alarm: Displays active alarms that have not been recovered and confirmed.

Not Recovered and Confirmed Alarm: Displays alarms that have not been recovered but the key button **CHECK** has been pressed.

Recovered and Unconfirmed Alarm: Displays alarms that have been recovered but the key button **CHECK** has not been pressed.

Recovered and Confirmed Alarm: Displays alarms that have been recovered and the key button **CHECK** has been pressed.

*1 Advanced mode only

■ **First Alarm** *1

An alarm that occurs in a state where no alarms have occurred is called the first alarm. Select the check boxes for the operations to execute when the first alarm occurs.

Display First Alarm to 1st line on List: Always displays the first alarm on the first line of the list.

Change the color of First Alarm: Changes the text color of the first alarm according to the **First Alarm Color** setting. **First Alarm Color** is configured on the **Format** tab.

■ **Operate the Alarm on List directly** *1

Select this check box to display the focus by pressing an alarm displayed on the list.

When an alarm is pressed with no focus displayed, the focus is displayed on that alarm.

When an alarm is pressed that does not have focus when the focus is displayed, the focus is moved to that alarm.

The focus is no longer displayed when an alarm with focus is pressed.

■ **Alarm Log Settings**

Displays the Alarm Log Settings dialog box.

*1 Advanced mode only

● Log Tab

(Show items detailed settings)

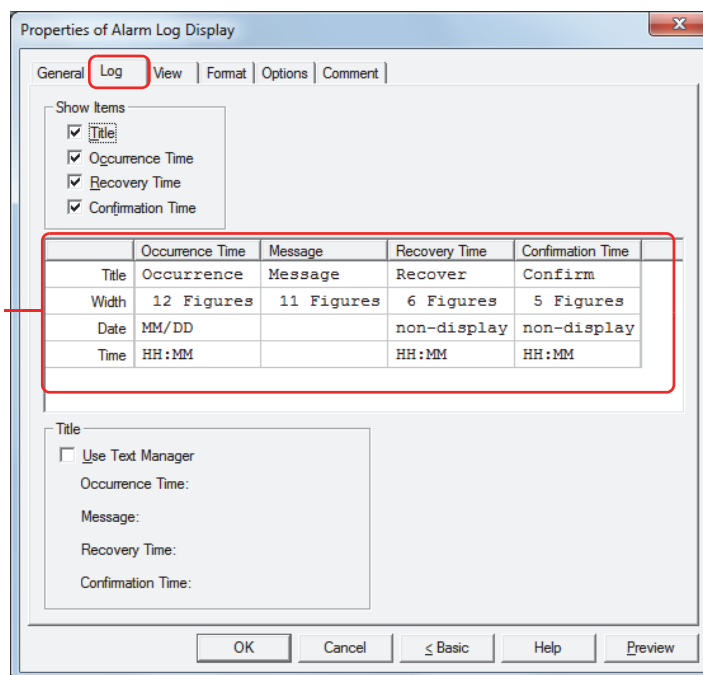

■ Show Items

Select these check boxes for the items to display on the Alarm Log Display.

- Title: Shows the titles on the first line of the list.
- Occurrence Time: Shows the time the alarm occurred.
- Recovery Time: Shows the time the alarm was recovered from.
- Confirmation Time: Shows the time the alarm was confirmed by pressing the key button **CHECK**.

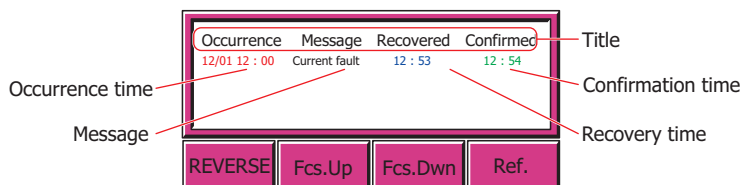

■ (Show items detailed settings)

Each of the show items selected by the check boxes under **Show Items** can be configured in detail here.

- Title: Enter the titles for the items to display. The maximum number is 20 characters. Double clicking the cell displays the Unicode Input dialog box. Enter the characters in the Unicode Input dialog box, and then click **OK**.
- Width: Specifies the number of characters to display (1 to 40). 1 is the width of a single-byte character, 2 is the width of a double-byte character.
- Date: Selects the display type of the date from the following.
YY/MM/DD, MM/DD/YY, DD/MM/YY, MM/DD, DD/MM, non-display
- Time: Selects the display type of the time from the following.
HH:MM, HH:MM:SS, non-display



- If the title contains a newline, the text after the newline is not displayed. However, if using a Windows font for the selected text ID, all the characters are displayed.
- If the title contains a language not supported as standard by the OS, the characters may be garbled when displaying the **(Show items detailed settings)**. However, the downloaded data is correctly displayed.



- If you change the display type for **Date** or **Time**, the number for **Width** is automatically adjusted.
- The text color for **Message** changes according to the alarm state. The text color for **Message** is configured by **Occurred Color**, **Recovered Color**, and **Confirmed Color** on the **Format** tab.

■ **Title**

Select this check box to use text registered in Text Manager for **Title** in the **(Show items detailed settings)**. The **Text ID** message configured for **Occurrence Time**, **Message**, **Recovery Time**, and **Confirmation Time** is displayed in **(Show Items detailed settings)**.

Text ID: Specifies the Text Manager ID number (1 to 32000) when using text registered in Text Manager.

Click to display Text Manager.

This option can only be configured when the **Use Text Manager** check box is selected.

● View Tab

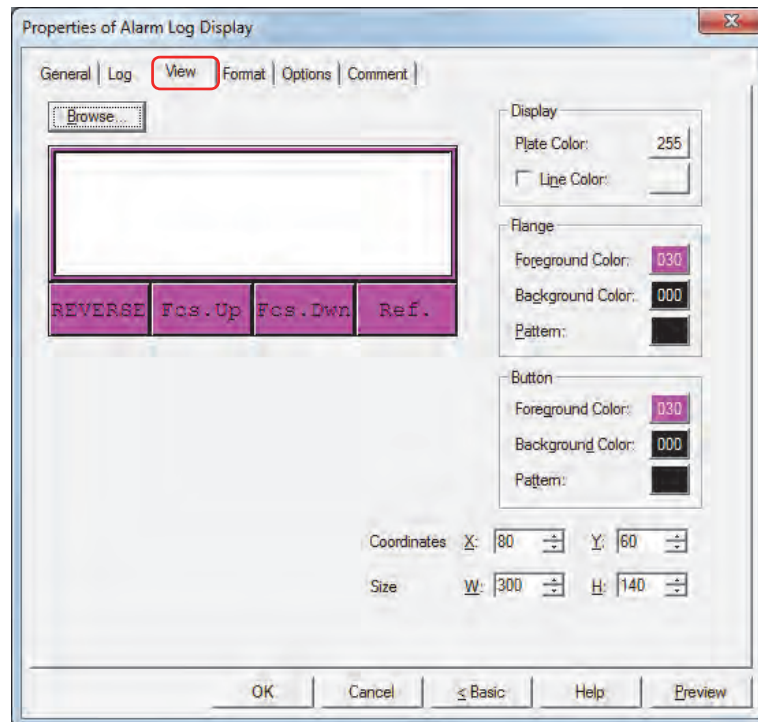

■ Browse

Select the type of graphic to represent the part from the list of graphics. Click this button to display the View Browser.

■ Plate Color

Selects the plate (color: 256 colors, monochrome: 8 shades).

Click this button to display the Color Palette. Select a color from the Color Palette.

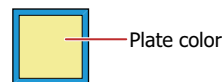

■ Line Color

When lines are displayed, select the check box and select line color (color: 256 colors, monochrome: 8 shades).

Click this button to display the Color Palette. Select a color from the Color Palette.



■ Flange

Foreground Color, Background Color:

Selects the foreground and background colors of the flange (color: 256 colors, monochrome: 8 shades).

Click this button to display the Color Palette. Select a color from the Color Palette.

Pattern:

Selects a pattern for the flange.

Click this button to display the Pattern Palette. Select a pattern from the Pattern Palette.



■ Buttons

Foreground Color, Background Color: Selects the foreground and background colors of the buttons (color: 256 colors, monochrome: 8 shades).
Click this button to display the Color Palette. Select a color from the Color Palette.

Pattern: Selects a pattern for the button.
Click this button to display the Pattern Palette. Select a pattern from the Pattern Palette.

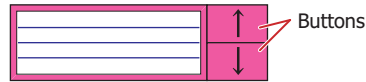

Can be set only when there are grouped Key Buttons.

■ Coordinates

X, Y: Sets the display position of parts using coordinates.
The X and Y coordinates of parts is defined relative to an origin at the top-left corner of the screen.

X: 0 to (Base Screen horizontal size - 1)

Y: 0 to (Base Screen vertical size - 1)

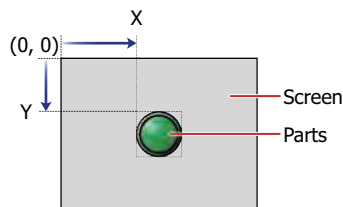

■ Size

W, H: Sets width and height to define the size of parts.

W: 20 to (Base Screen horizontal size)

H: 20 to (Base Screen vertical size)

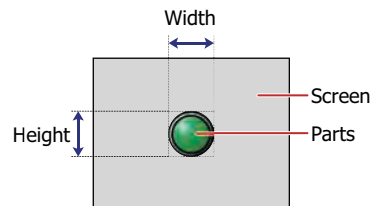

● Format Tab

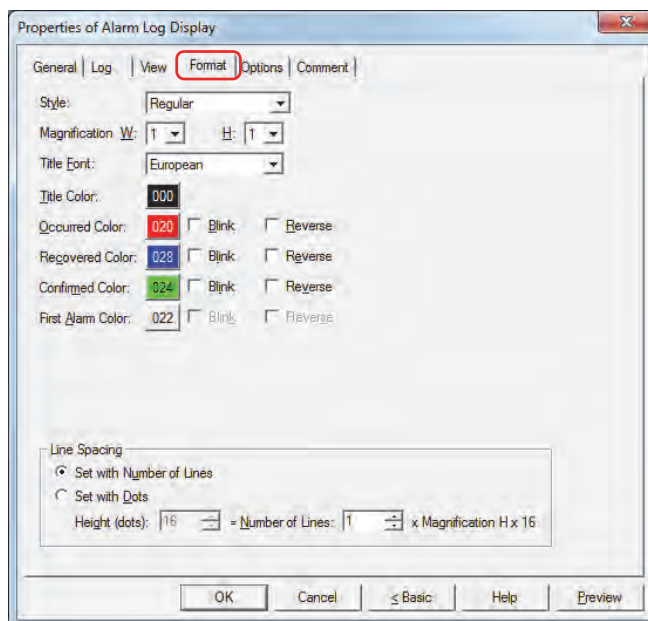

■ Style

Selects **Regular** or **Bold** for text style.

■ Magnification

W, H: Selects text magnification (0.5, 1 to 8).

■ Title Font

Select the font that will be used for the title from the following options.

Japanese, European, Chinese, Taiwanese, Korean, Central European, Baltic, Cyrillic

The characters that can be displayed depend on the font. For details, refer to Chapter 2 "1.2 Available Text" on page 2-5.

■ Title Color

Select the color (color: 256 colors, monochrome: 8 shades) of the text for titles.

Click this button to display the Color Palette. Select a color from the Color Palette.

■ Occurred Color, Recovered Color, Confirmed Color, First Alarm Color^{*1}

Select the color (color: 256 colors, monochrome: 8 shades) of the occurred alarm, recovered alarm, confirmed alarm and first alarm.

Click this button to display the Color Palette. Select a color from the Color Palette.

Blink^{*1}: Select this check box to flash alarms that are displayed on the list.

The flash interval is specified in **Blinking Cycle** on the **System** tab in the Project Settings dialog box.

Reverse^{*1}: Select this check box to show in reverse, the text color and plate color of alarms that are displayed on the list.

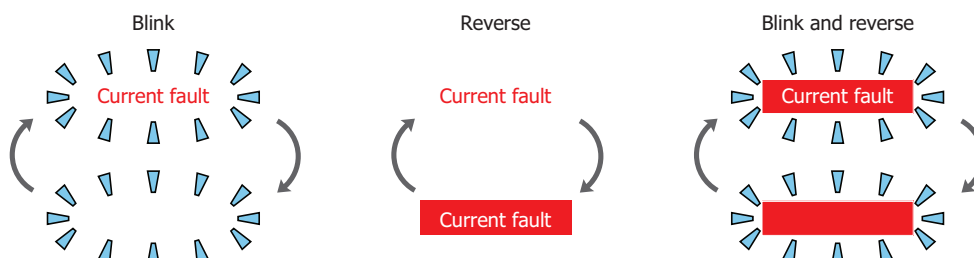

When the Key Button **CHECK** is pressed before recovering a triggered alarm, the alarm display will change from the Occurred Color to the Confirmed Color. After this, the alarm that has changed to the Confirmed Color will remain in that color and will not change to the Recovered Color even when recovered.

*1 Advanced mode only

■ **Line Spacing***1

Selects the specification method for line spacing in the list and configures the line spacing.

Set with Number of Lines:

Specifies the number of lines for the message to display for one alarm line.

Number of Lines: Enter the number of lines (1 to 10). To completely display a message that contains newlines, a number of lines that is equal to or greater than the number of message lines is required.

When you enter a value in **Number of Lines**, **Height (dots)** is automatically calculated according to the display area.

The relationship between the number of lines and the height (dots) is height (dots) = number of lines x magnification H x 16.

Number of Lines	Magnification H	Height		
1	1	16 dots	↓	When the message is 2 lines, 2nd line is not shown.
			↑	
			↓	
2	1	32 dots	↓	Number of Lines
			↑	Magnification H
			↓	Height
			↑	3
			↓	2
			↑	16 dots
			↓	
3	1	48 dots	↓	
			↑	



Since the alarm line spacing is adjusted with the number of lines for the message fixed, this option is convenient to use when displaying multi-line messages.

Set with Dots: Specifies the line spacing for the message to display for one alarm line in dots.

Height (dots): Enter the height (8 to 160). To completely display a message, a height equal to or greater than **Magnification H** x 16 dots x the number of message lines is required.

When **Magnification H** is 1

To display a one-line message, 1 x 16 = 16 dots, a height of 16 dots or higher is required.

Height	↓	
16 dots		Current fault has occurred
	↑	Pump fault has occurred

To display a two-line message, 2 x 16 = 32 dots, a height of 32 dots or higher is required.

Height	↓	Height	↓	
32 dots		16 dots		Current fault
	↑		↑	Pump fault
				When the message is two lines, The second line is not shown.

When **Magnification H** is 2

To display a one-line message, 1 x 32 = 32 dots, a height of 32 dots or higher is required.

Height	↓	
32 dots		Current fault has occurred
	↑	Pump fault has occurred

To display a two-line message, 2 x 32 = 64 dots, a height of 64 dots or higher is required.

Height	↓	Height	↓	
64 dots		32 dots		Current fault
	↑		↑	Pump fault
				When the message is two lines, The second line is not shown.



Since only one line of the title is displayed, the title line spacing = 1 (number of lines) x **Magnification H** x 16, regardless of the **Line Spacing** setting.

Example: When **Magnification H** is 1, the title line spacing = 1 x 1 x 16 = 16 dots

When **Magnification H** is 2, the title line spacing = 1 x 2 x 16 = 32 dots

*1 Advanced mode only

● Options Tab

The **Options** tab is displayed in Advanced mode.

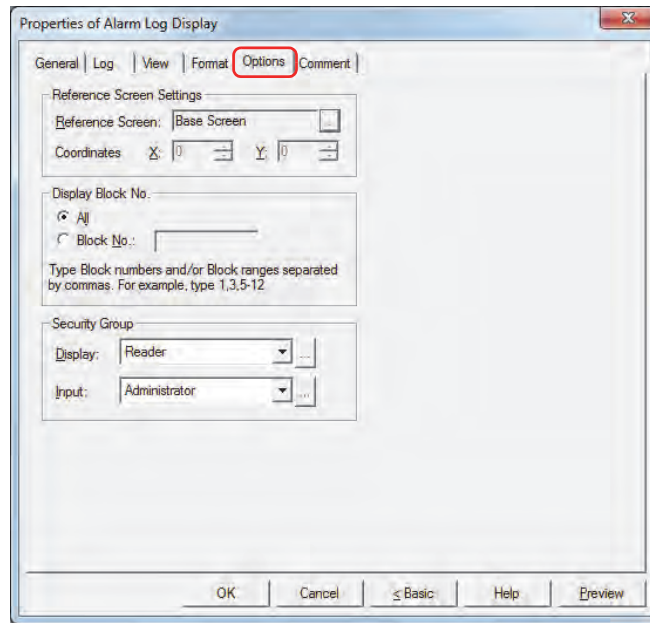

■ Reference Screen Settings

The **Options** tab is used to configure the reference screen. The reference screen is a Base Screen or Popup Screen associated with each individual message. The reference screen is displayed when the key button **Ref.** is pressed.

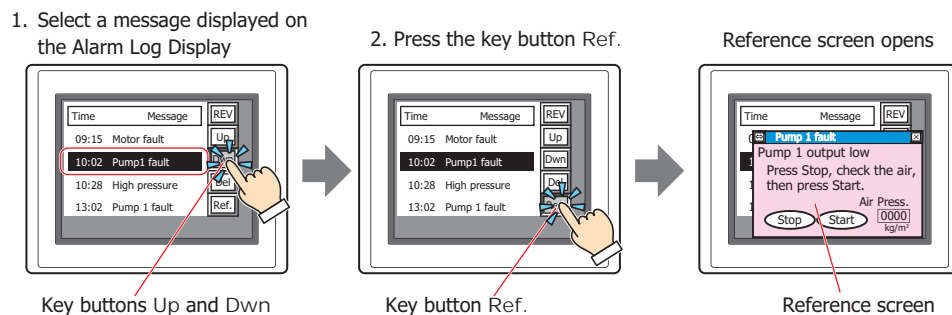

Reference Screen: Displays the type of screen selected in **Reference Screen** on the **Channel** tab in the Alarm Log Settings dialog box.

Click to display the Alarm Log Settings dialog box.

When displaying a reference screen, select either **Base Screen** or **Popup Screen** as the reference screen type.

When not displaying a reference, select **Not Use**.

Coordinates X, Y: Specifies the coordinates to display the reference screen.

With the upper-left corner of the screen as the origin, the X and Y coordinates are the upper-left corner of the reference screen.

This option can only be configured when **Base Screen** or **Popup Screen** is selected for **Reference Screen**.

Specify the coordinates in 1 dot units.

X: 0 to (Base Screen horizontal size - 1)

Y: 0 to (Base Screen vertical size - 1)



If you overlap the reference screen key button and the move focus key buttons, the reference screen can be switched and checked while moving the focus.

■ Display Block No.

Specifies the range of block numbers that will display the collected alarm log data.

All: Displays the data for all blocks.

Block No.: Displays only the data for the specified blocks in the Alarm Log Display. Alarms in unspecified blocks are not displayed, even if active.

Individual block numbers can be specified by separating the numbers with “,”, continuous regions can be specified with “-”.

Example: When the number of blocks is 6, enter the following.

To specify blocks 1 to 3: 1-3

To specify blocks 1, 3, 6: 1, 3, 6

To specify blocks 1, 4 to 6: 1, 4-6

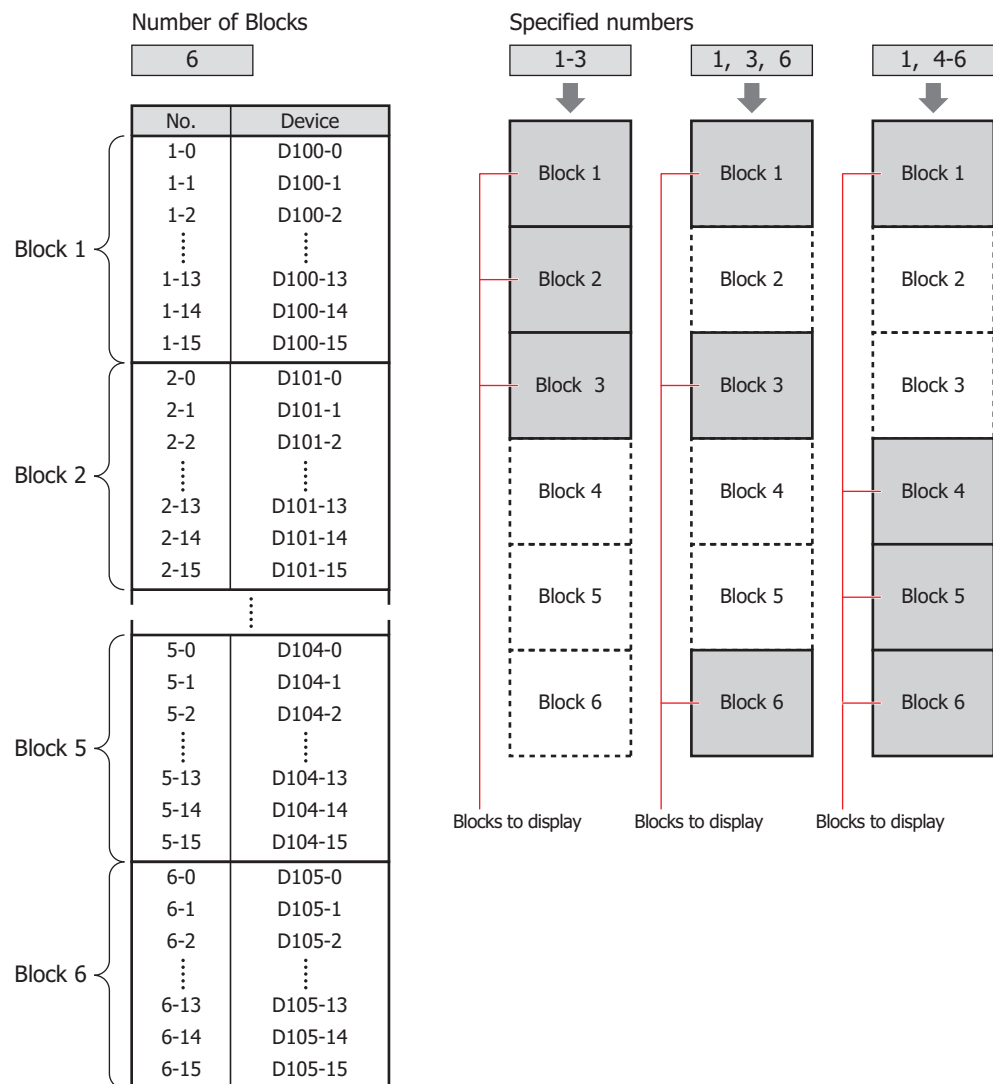

- To display the alarms set in blocks 65 to 128 of the Alarm Log settings, select **All** under **Display Block No.**. If **Block No.** is selected, only blocks 1 to 64 can be specified.
- For the number of blocks, refer to Chapter 13 “Number of Blocks” on page 13-16.

Security Groups

Security groups are a security function for restricting the display and operation of parts.

Display: Selects the security group for which display of parts is restricted. (Default: None)

None: No security function is used.

Administrator, Operator, Reader: Three security groups are set up by default.

Click to display the Security Group Settings dialog box. If you create a security group on the Security Group Settings dialog box, you can select that created group. For details, refer to Chapter 21 "2.2 Adding and Editing Security Groups" on page 21-15.

Input: Selects the security group for which operation of parts is restricted. (Default: None)

None: No security function is used.

Administrator, Operator, Reader: Three security groups are set up by default.

Click to display the Security Group Settings dialog box. If you create a security group on the Security Group Settings dialog box, you can select that created group. For details, refer to Chapter 21 "2.2 Adding and Editing Security Groups" on page 21-15.



- The security group for input can only be configured when there are grouped key buttons.
- For details about security functions, refer to Chapter 21 "User Accounts and the Security Function" on page 21-1.

Example: If the user and security group for a part are set as follows:

User Name	User1	User2	User3
Security Group	None	Group A	Group A, Group B

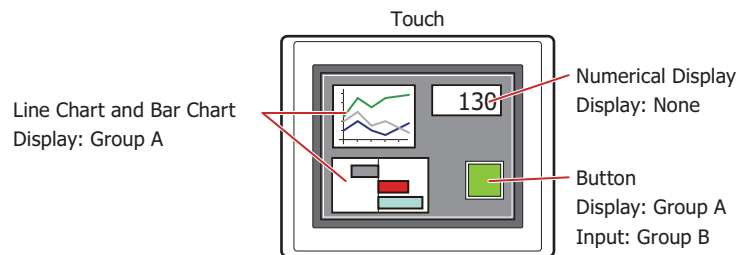

For User 1, who is not included in the specified security group, Group A parts are not displayed.

If the Password Screen is now opened and a switch is made to User 2 of Group A, Group A parts are displayed.

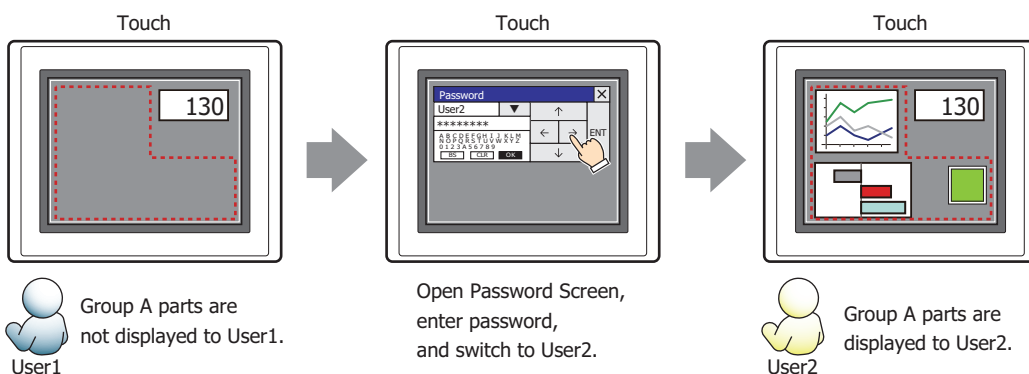

Since the display security group is Group A, User 2 (of Group A) can view the buttons. But since the input security group is Group B, User 2 cannot operate the buttons.

Suppose that the Password Screen is now opened and a switch is made to User 3, who is part of both Group A and Group B. Group A buttons can be displayed, and Group B buttons can be operated.

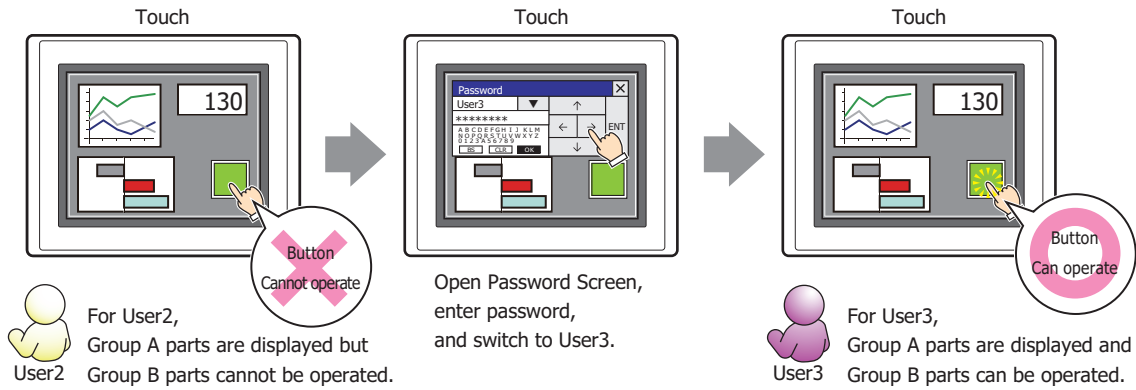

● Comment Tab

The **Comment** tab is used to specify the parts arranged on the editing screen, and the popup text displayed when the mouse pointer is placed close to **No.**, **Name**, or **Type** in the object list.



When there are multiple parts of the same shape on the screen, this feature makes it possible to distinguish between the parts without displaying the Properties dialog box for each part, by just mousing over the part.

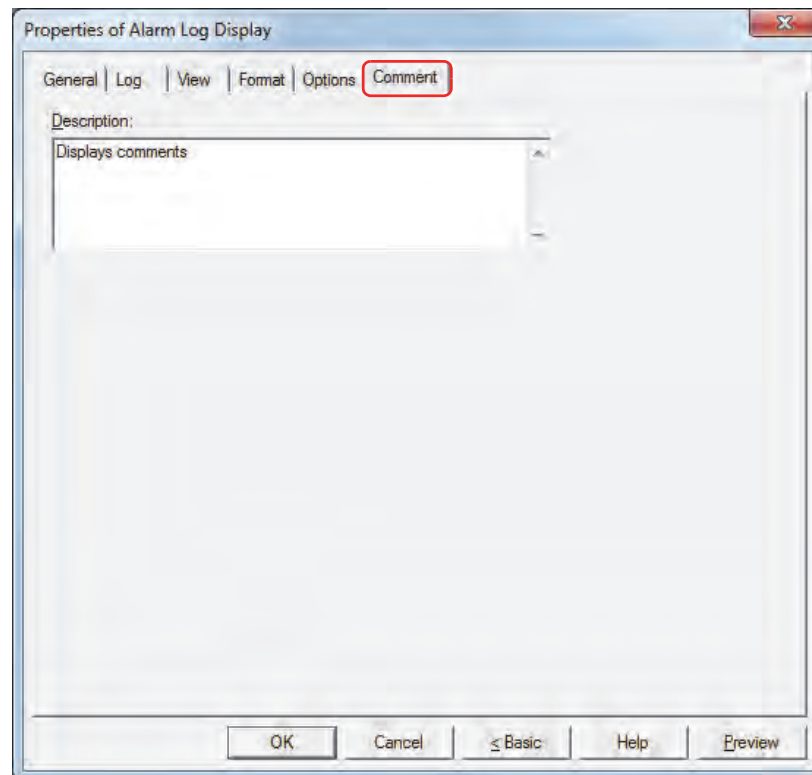

■ Description

Enter a comment about parts. The maximum number is 80 characters.

Example: When mousing over the Alarm Log Display on the editing screen

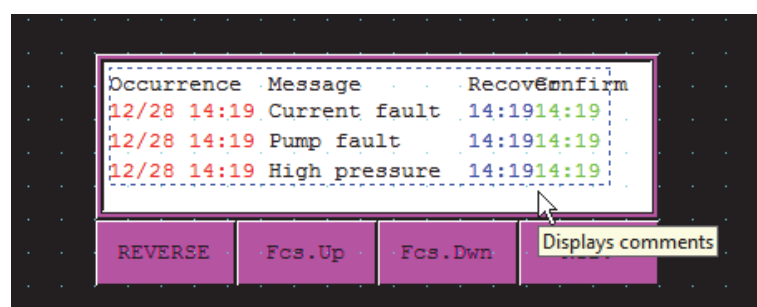

8 Numerical Display

8.1 How the Numerical Display is Used

The Numerical Display is used to display the value of a word device in the specified format.

- Display the current value of device

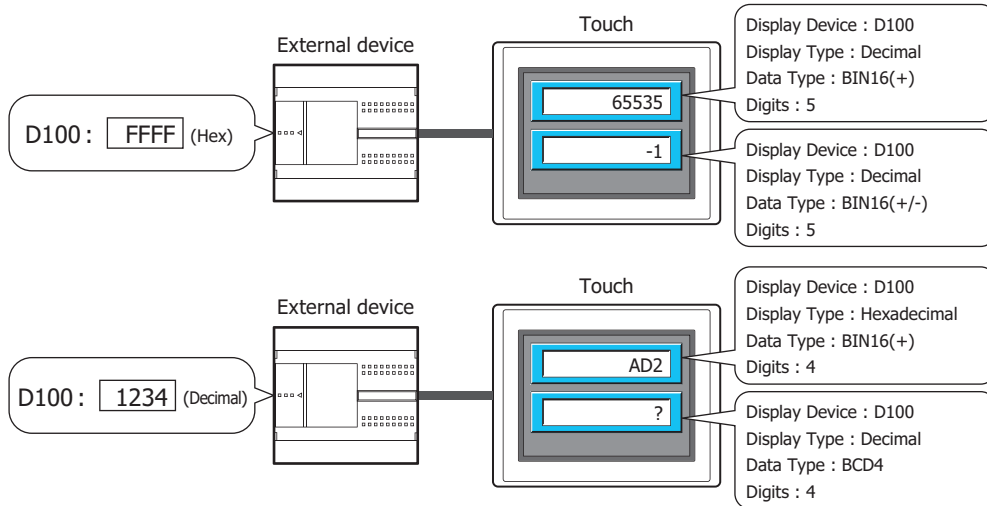

- Display the decimal point

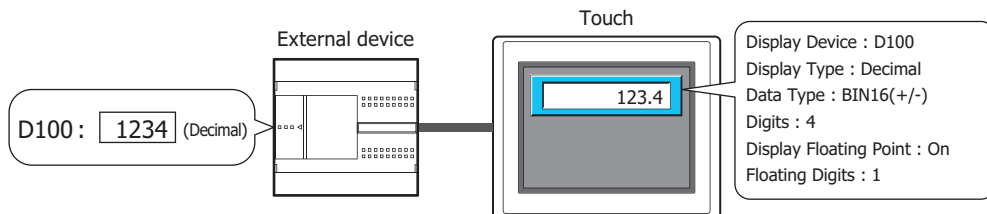

- Display the unit

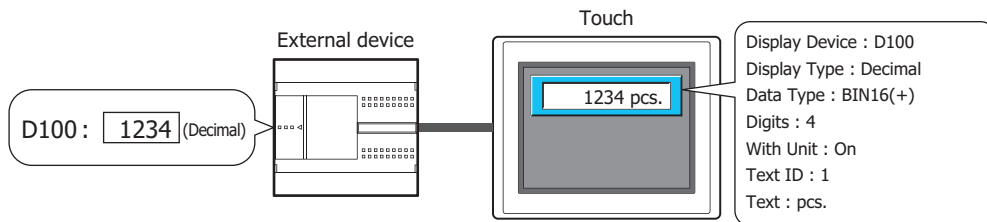

- Blink a value that exceeds the minimum or the maximum

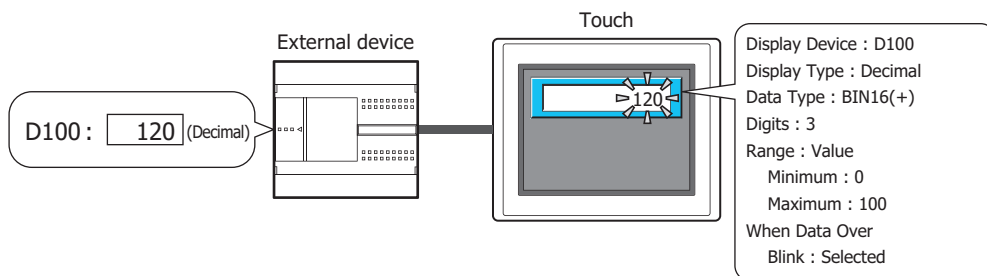

8.2 Numerical Display Configuration Procedure

This section describes the configuration procedure for Numerical Displays.

- 1 On the **Home** tab, in the **Parts** group, click **Data Displays**, and then click **Numerical Display**.

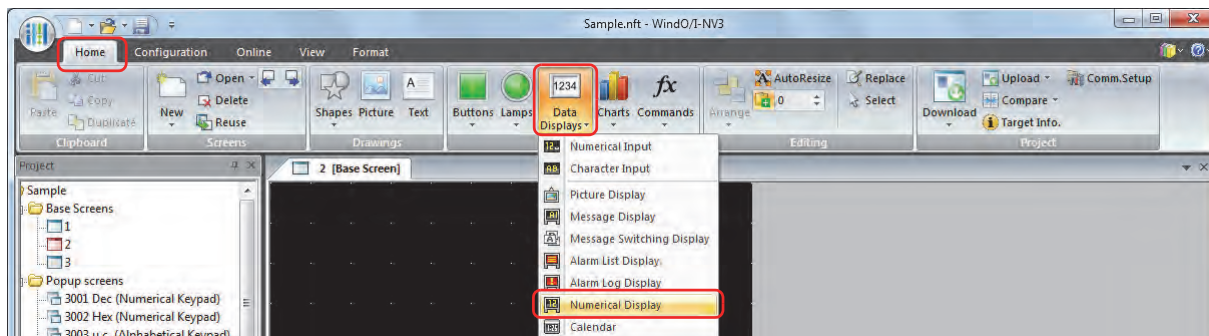

- 2 Click a point on the edit screen where you want to place the Numerical Display.
- 3 Double-click the dropped Numerical Display and a Properties dialog box will be displayed.
- 4 Change the settings on each tab as necessary.

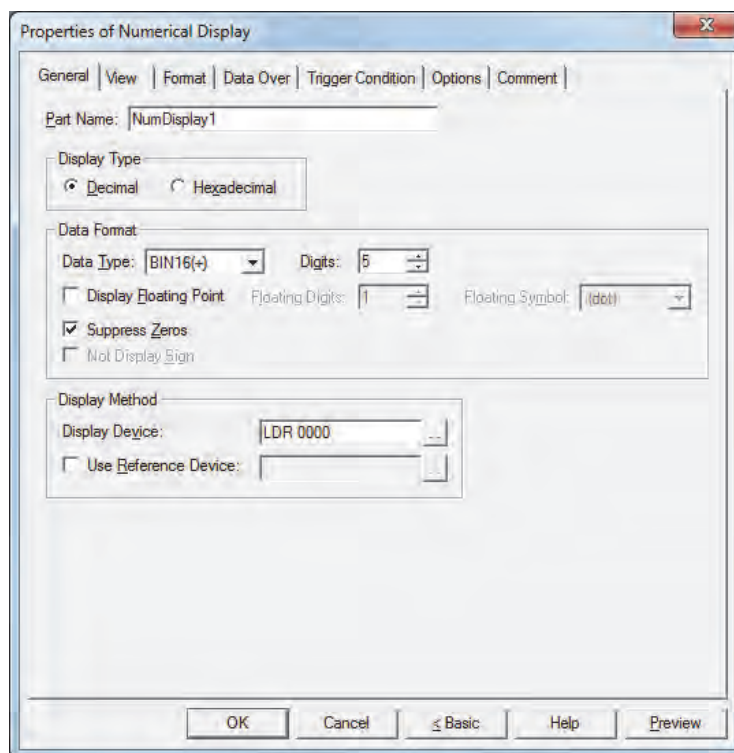

The **Data Over** tab, **Trigger Condition** tab and **Options** tab only appear in Advanced mode. To switch to Advanced mode, click **Advanced**.

8.3 Properties of Numerical Display Dialog Box

This section describes items and buttons on the properties dialog box.

● General Tab

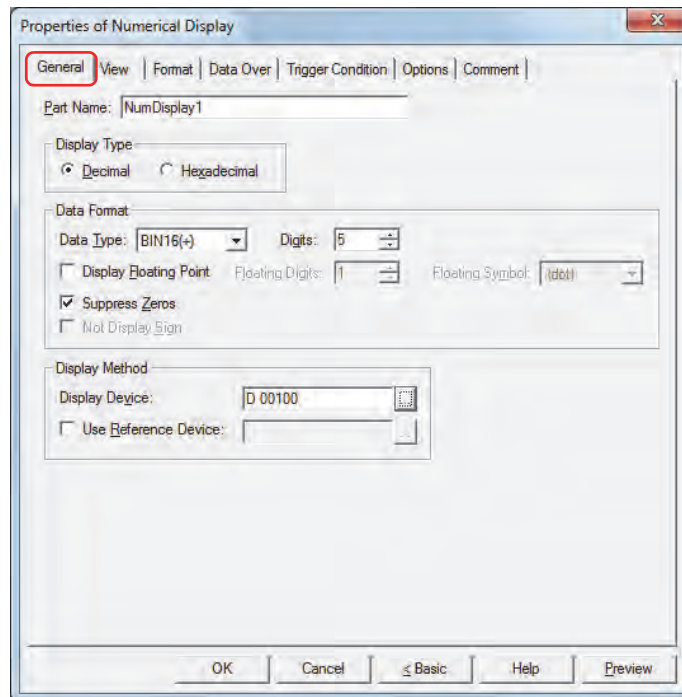

■ Part Name

Enter a name for the part. The maximum number is 20 characters.

■ Display Type

Selects the display type for the value as **Decimal** or **Hexadecimal**.

■ Data Format

Data Type:

Selects the type of data for the value.

The data type that can be configured differs according to **Display Type**. For the data types that can be configured, see the table for **Digits**.

For details, refer to Chapter 2 "1.1 Available Data" on page 2-1.

Digits:

Specifies the digits to display. The range of digits that can be set varies based on the display type and data type. The digits that can be set are as follows.

Display Type	Data Type	Digits
Decimal display	BIN16 (+), BIN16 (+/-)	1 to 5
	BIN32 (+), BIN32 (+/-)	1 to 10
	BCD4	1 to 4
	BCD8	1 to 8
	float32	1 to 10
Hexadecimal display	BIN16 (+)	1 to 4
	BIN32 (+)	1 to 8

Display Floating Point:

Select this check box to display the decimal point.



When the **Display Floating Point** check box is selected and **BIN16(+)**, **BIN16(+/-)**, **BIN32(+)**, **BIN32(+/-)**, **BCD4**, or **BCD8** is selected for **Data Type**, the source data is an integer, but the value is displayed with the decimal point added at the configured floating digits.

However, if **float32** is selected for **Data Type**, the source data is a decimal value.

Floating Digits: Specifies the number of digits for the fractional part of the decimal value out of the number of digits specified by **Digits**.
This option can only be configured when the **Display Floating Point** check box is selected. The range of digits that can be set for the fractional part varies based on the display type and data type. The range of digits that can be set for the fractional part is as follows.

Display Type	Data Type	Floating Digits
Decimal display	BIN16 (+), BIN16 (+/-)	1 to Digits
	BIN32 (+), BIN32 (+/-)	1 to Digits
	BCD4	1 to Digits
	BCD8	1 to Digits
	float32	1 to 8
Hexadecimal display	BIN16 (+)	--
	BIN32 (+)	--

Floating Symbol^{*1}: Selects the decimal point symbol from the following.
.(dot), :(colon), ;(semicolon), ,(comma), /(slash)
This option can only be configured when the **Display Floating Point** check box is selected.

Example: When **Digits** is 4 and **Floating Digits** is 2

When **Floating Symbol** is **.(dot)** 12.34

When **Floating Symbol** is **/(slash)** 12/34

Suppress Zeros: Select this check box to hide "0" for the upper digits of the integer part.

Example: **Suppress Zeros** selected: 1234

Suppress Zeros cleared: 00001234

Not Display Sign: Select this check box to hide the - (negative) symbol when displaying negative values.
This option can only be configured when **Data Type** is **BCD4**, **BCD8**, or **float32**.

■ Display Method

Specifies the source of the value to display.

Display Device: Specifies the word device that stores the value to display.

Click to display the Device Address Settings dialog box. For the device address configuration procedure, refer to Chapter 2 "5.1 Device Address Settings" on page 2-61.

Use Reference Device^{*1}: Select this check box and specify a device to change the **Display Device** by the value of this device.

Click to display the Device Address Settings dialog box. For the device address configuration procedure, refer to Chapter 2 "5.1 Device Address Settings" on page 2-61. For details on indirect reading, refer to Chapter 2 "Indirect Read and Indirect Write Settings" on page 2-4.

*1 Advanced mode only

● View Tab

The **View** tab is used to configure the external form of the part including its color and shape.

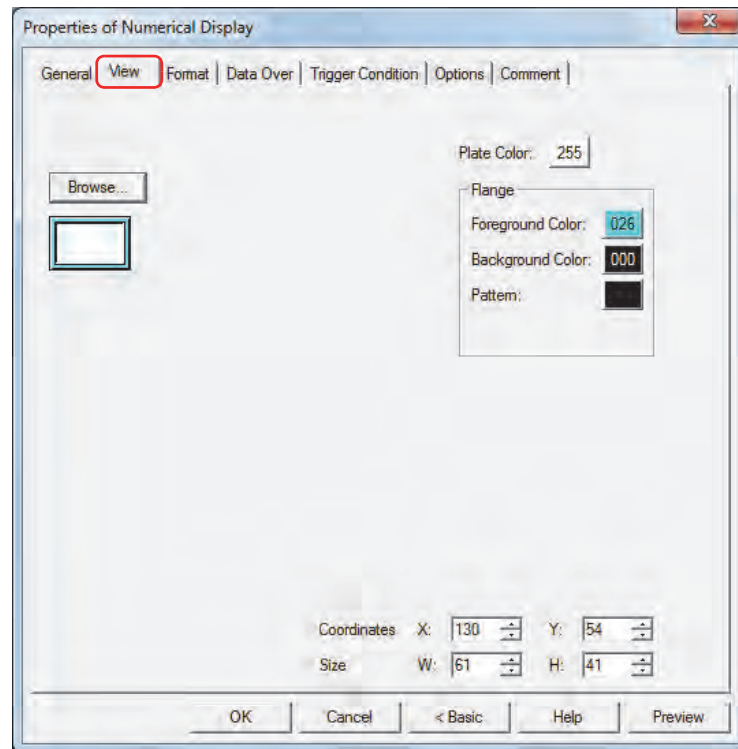

■ Browse

Select the type of graphic to represent the part from the list of graphics. Click this button to display the View Browser.

■ Plate Color

Selects the plate color of the standard graphic (color: 256 colors, monochrome: 8 shades).

Click the **Color** button to display the Color Palette. Select a color from the Color Palette.



■ Flange

Foreground Color, Background Color:

Selects the foreground and background colors of the flange of the standard graphic (color: 256 colors, monochrome: 8 shades).

Click the **Color** button to display the Color Palette. Select a color from the Color Palette.

Pattern:

Selects a pattern for the flange of the standard graphic.

Click the **Pattern** button to display the Pattern Palette. Select a pattern from the Pattern Palette.

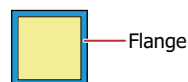

■ Coordinates

- X, Y: Sets the display position of parts using coordinates.
 The X and Y coordinates of parts is defined relative to an origin at the top-left corner of the screen.
- X: 0 to (Base Screen horizontal size - 1)
- Y: 0 to (Base Screen vertical size - 1)

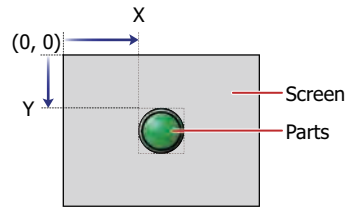

■ Size

- W, H: Sets width and height to define the size of parts.
- W: 5 to (Base Screen horizontal size)
- H: 5 to (Base Screen vertical size)

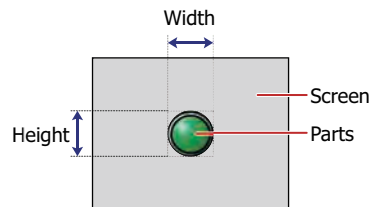

● Format Tab

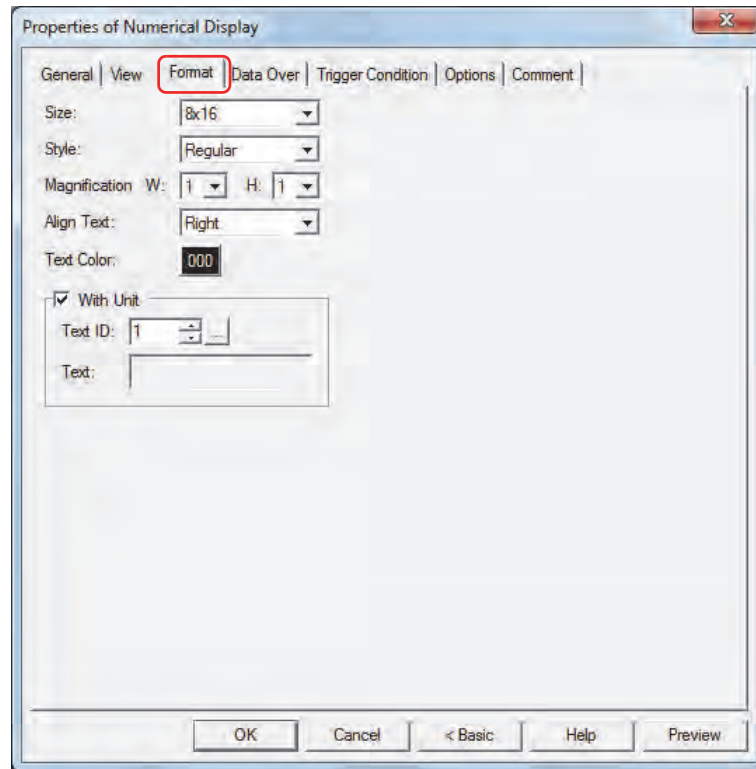

■ Size

Selects the text size as **8x16** or **16x16**.

■ Style

Selects **Regular** or **Bold** for text style.

■ Magnification

W, H: Selects text magnification (0.5, 1 to 8).

■ Align Text

Selects the text alignment in the horizontal direction from the following.

Left, Center, Right

For details, refer to Appendix "5 Text Alignment" on page A-5.

■ Text Color

Selects the color of displayed text (color: 256 colors, monochrome: 8 shades).

Click the **Color** button to display the Color Palette. Select a color from the Color Palette.

■ With Unit*¹

Select this check box to display units or other characters at the end of a number. Displayed characters must be registered in Text Manager. The displayed text color will be as set for **Text Color** under the **Format** tab.

Text ID: Specifies the Text Manager ID No. (1 to 32000).

Click to display Text Manager.

Text: Displays the characters of the specified Text ID.



- The maximum number that can be displayed with this function is 4 characters. The fifth and subsequent characters of a character string are not displayed. However, if Windows Font is set for the specified Text ID characters all the characters are displayed.
- If a carriage return (CR) is included the characters after the CR are not displayed.

*1 Advanced mode only

● Data Over Tab

The **Data Over** tab is displayed in Advanced mode.

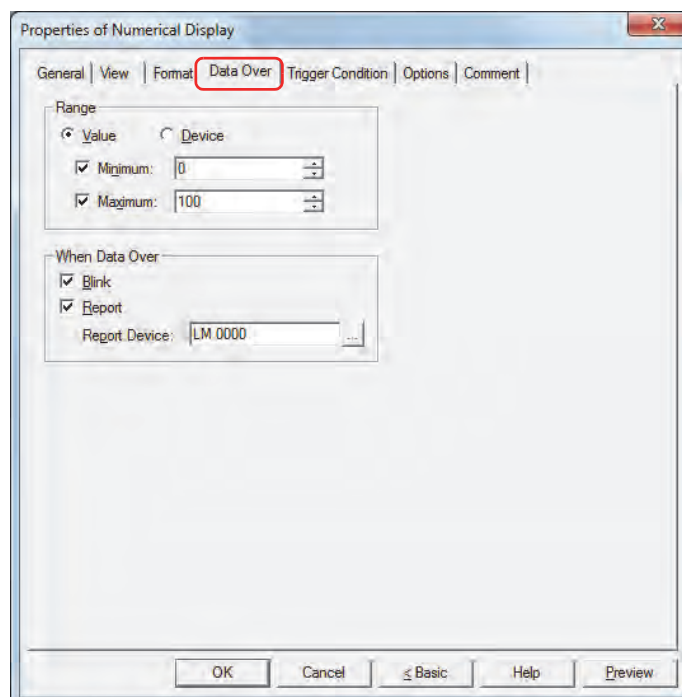

■ Range

Select data type.

Value: Specifies the minimum and/or the maximum as a constant.

Device: Specifies the minimum and/or the maximum as a value of word device.

Specifies the allowable range of values to display.

Minimum, Maximum: Select these check boxes to specify the minimum and/or maximum.

The minimum and maximum that can be specified when **Value** is selected vary based on the data type selected with **Data Format** on the **General** tab. For details on data types, refer to Chapter 2 "1.1 Available Data" on page 2-1.

When **Device** is selected, these options specify the source word devices.

Click to display the Device Address Settings dialog box. For the device address configuration procedure, refer to Chapter 2 "5.1 Device Address Settings" on page 2-61.



- Select **BIN16(+)**, **BIN16(+/-)**, **BIN32(+)**, **BIN32(+/-)**, **BCD4** or **BCD8** for **Data Type** under the **General** tab, and to display a fractional number specify the values of **Minimum** and **Maximum** as an integer.
Example: To set a value of "1.25" for the upper limit, enter "125".
- If the value of device to display exceeds the data range that can be processed for the data type selected under **Data Format** on the **General** tab, "?" is displayed.

■ **When Data Over**

These options configure the operation of the part when the allowable range is exceeded.

These options can only be configured when the **Minimum** or **Maximum** check boxes are selected under **Range**.

Blink: Select this check box to make the value blink when the displayed data exceeds the allowable range.

Report: Select this check box and specify the device to write 1 in the report device when the displayed data exceeds the allowable range.

Click to display the Device Address Settings dialog box. For the device address configuration procedure, refer to Chapter 2 “5.1 Device Address Settings” on page 2-61.

Example: If the value of word device of the reading source is “120,” which is higher than the upper limit of “100,” or “-10,” which is below the lower limit of “0,” a value of 1 will be written to LM0 and the displayed numerical value will blink.

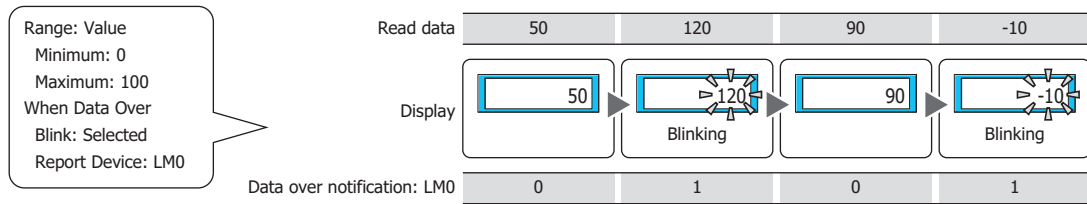

● Trigger Condition Tab

The **Trigger Condition** tab is displayed in Advanced mode.

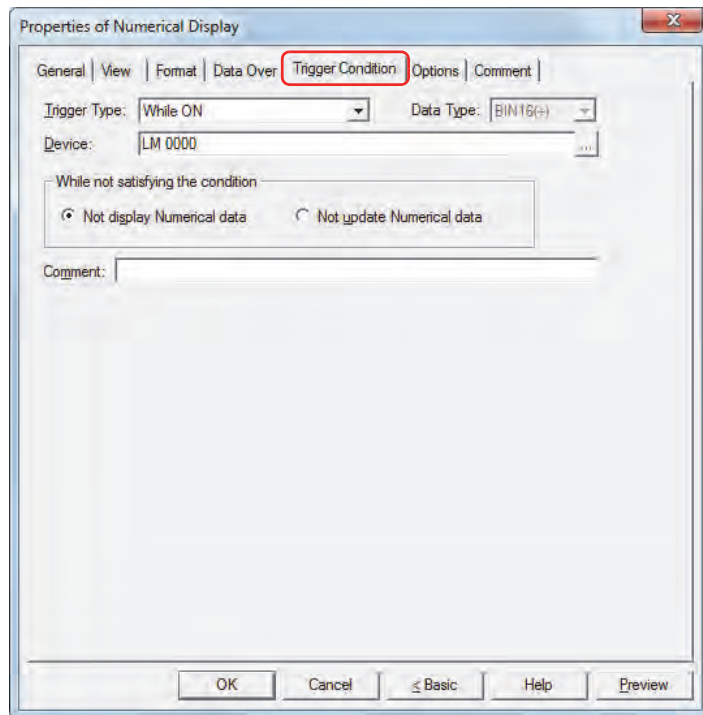

The Numerical Display is enabled while the condition is satisfied, and it is disabled while the condition is not satisfied. Select the operation when the condition is not satisfied as **Not display Numerical data** or **Not update Numerical data** under **While not satisfying the condition**.

Example: When **Trigger Type** is **While ON**, **Device** is LM0, and **While not satisfying the condition** is **Not display Numerical data**

While LM0 is 0, the condition is not satisfied and the Numerical Display does not display the number.

While LM0 is 1, the condition is satisfied and the Numerical Display displays the number.

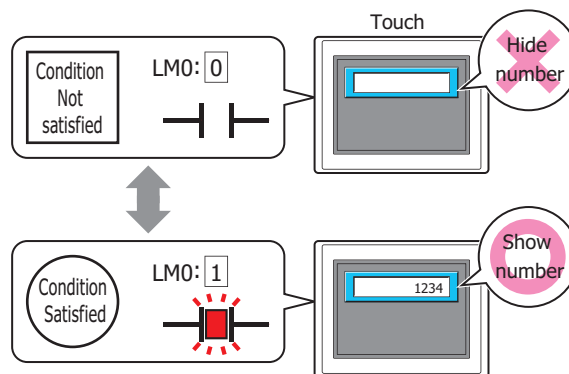

Data over does not operate for hidden Numerical Displays. Data over is reported if the minimum or maximum is exceeded when the Numerical Display changes from hidden to displayed.

■ Trigger Type

Selects the condition to enable the Numerical Display from the following.

Always Enabled: The Numerical Display is always enabled.

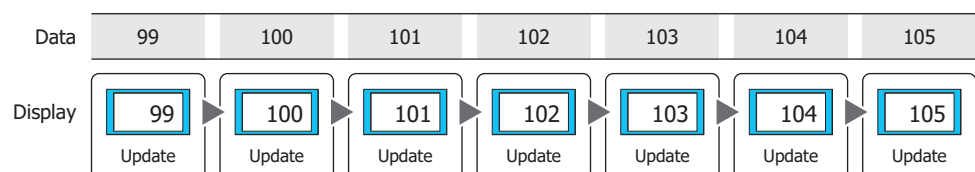

While ON: Enables the Numerical Display when the value of device is 1.
 Example: When **While not satisfying the condition** is **Not update Numerical data**

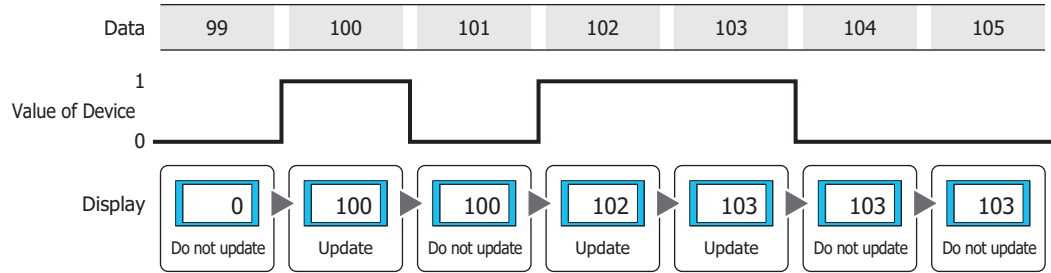

While OFF: Enables the Numerical Display when the value of device is 0.
 Example: When **While not satisfying the condition** is **Not update Numerical data**

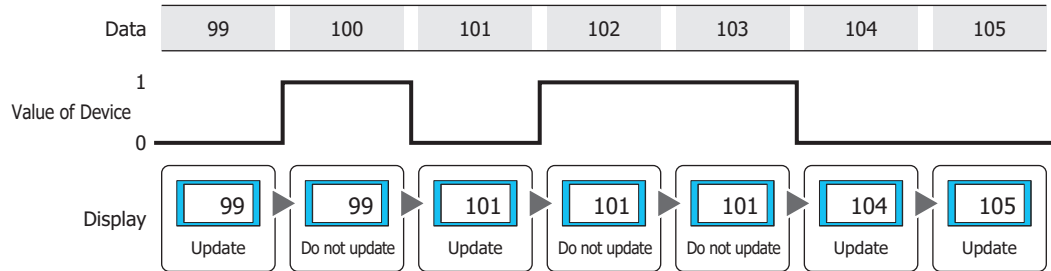

While satisfying the condition:

Enables the Numerical Display when the condition is satisfied.
 Example: When **While not satisfying the condition** is **Not update Numerical data**

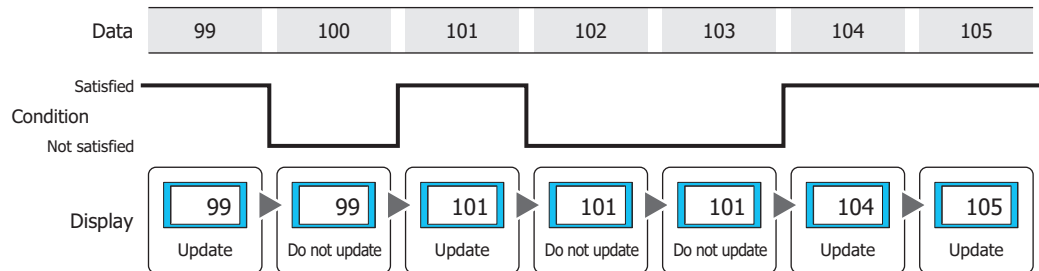

■ Data Type

Selects the data type handled by the condition formula.
 Can only be set if **While satisfying the condition** is selected as **Trigger Type**.
 For details, refer to Chapter 2 "1.1 Available Data" on page 2-1.

■ Device

Specifies the bit device or bit of the word device to serve as condition.
 Can only be set if **While ON** or **While OFF** is selected as **Trigger Type**.

Click  to display the Device Address Settings dialog box. For the device address configuration procedure, refer to Chapter 2 "5.1 Device Address Settings" on page 2-61.

■ Condition

Sets the condition formula.
 Can only be set if **While satisfying the condition** is selected as **Trigger Type**.

Click  to display the Trigger Condition Settings dialog box. For the conditional expression configuration procedure, refer to Chapter 2 "5.2 Setting Conditional Expressions" on page 2-63.

■ While not satisfying the condition

Selects the operation of the Numerical Display when the condition is not satisfied.

Not display Numerical data: The plate and flange are displayed, but number is not displayed.

Not update Numerical data: The last updated number is displayed. The number does not change.

■ Comment

Enter a comment about trigger conditions. The maximum number is 80 characters.

● Options Tab

The **Options** tab is displayed in Advanced mode.

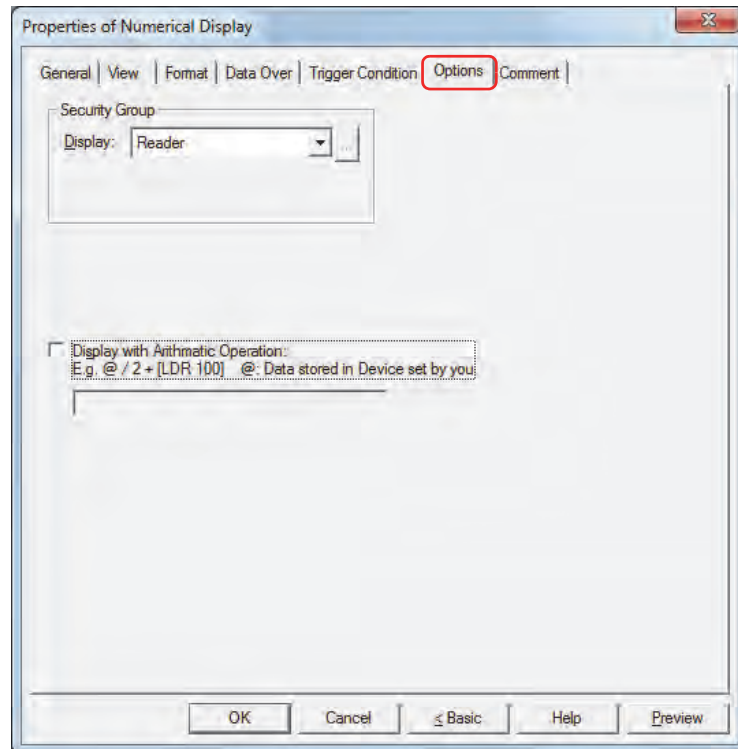

■ Security Group

Security groups are a security function for restricting the display and operation of parts.

Display: Selects the security group for which display of parts is restricted. (Default: None)

None: No security function is used.



Administrator, Operator, Reader: Three security groups are set up by default.

Click  to display the Security Group Settings dialog box. If you create a security group on the Security Group Settings dialog box, you can select that created group. For details, refer to Chapter 21 "2.2 Adding and Editing Security Groups" on page 21-15.



For details about security functions, refer to Chapter 21 "User Accounts and the Security Function" on page 21-1.

Example: If the user and security group for a part are set as follows:

User Name	 User1	 User2
Security Group	None	Group A

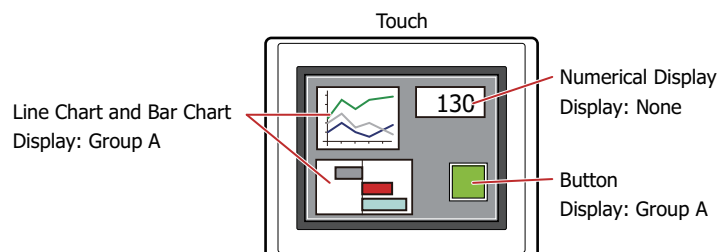

For User 1, who is not included in the specified security group, Group A parts are not displayed. If the Password Screen is now opened and a switch is made to User 2 of Group A, Group A parts are displayed.

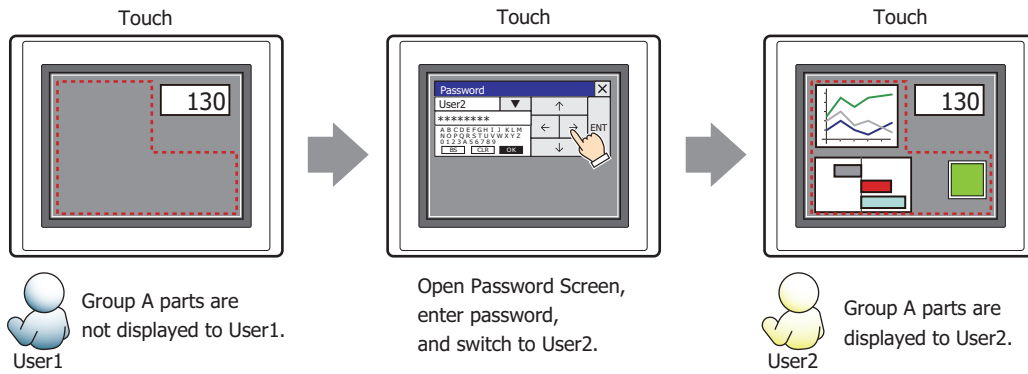

■ Display with Arithmetic Operation

To apply arithmetic operations to values of devices and writing the results, select this check box and input the arithmetic formula.

Example: To multiply the value of device when displayed by 60

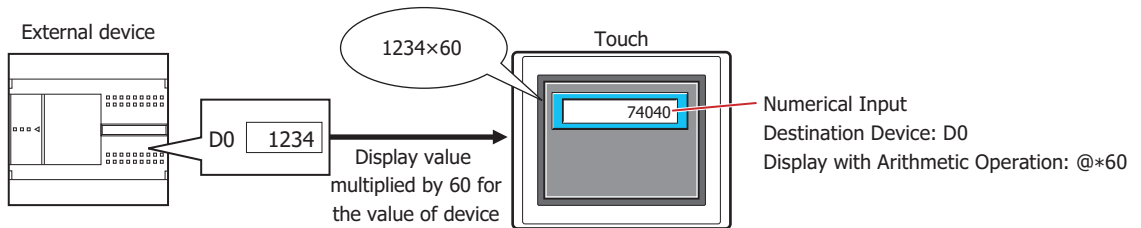

Arithmetic Formulas

Arithmetic formulas can be specified by freely combining multiple kinds of data and operators in the following format.

[Data] [Operator] [Data]
to
[Data] [Operator] [Data] [Operator] [Data] [Operator] [Data] [Operator] [Data] [Operator] [Data] ... (up to 120 characters)

- There is no limit on the number of data items or number of operators. However, the maximum number is 120 characters.
- Round brackets can be used.

Data

Item	Description
@	The device on which the arithmetic operation is performed is specified in the arithmetic formula. Only 1 device can be set for an arithmetic operation. The device is as specified for Display Device on the General tab.
Value	Sets the constant values for the arithmetic formula. The values that can be set depend on the data type selected in Data Format on the General tab. For details, refer to Chapter 2 "1.1 Available Data" on page 2-1.
Device	Specifies the bit device or word device for the arithmetic formula.

Operators

Specify the type of arithmetic operation to be performed on the data. The operator priority is the same as for scripts. For details, refer to Chapter 20 "6.4 About the Priority of the Operator" on page 20-53.

Item	Description		
Arithmetic operators	Sets the arithmetic operators.		
	+	Addition	Adds [a] and [b].
	-	Subtraction	Subtracts [b] from [a].
	*	Multiplication	Multiplies [a] and [b].
	/	Division	Divides [a] by [b].
	%	Modulo	Calculates remainder after dividing [a] by [b].
Bit operator	Sets the bit operator.		
	&	Logical AND	Calculates the logical product (AND) of each bit of [a] and [b].
		Logical OR	Calculates the logical sum (OR) of each bit of [a] and [b].
	^	Logical XOR (exclusive OR)	Calculates the exclusive logical sum (XOR) of each bit of [a] and [b].
	<<	Left shift	Shifts each bit of [a] to left by [b] bit(s).
	>>	Right shift	Shifts each bit of [a] to right by [b] bit(s).

Examples of Arithmetic Formula Input

Input Examples	Description
@ + 1	To perform the arithmetic operation and input the result, add 1 to the value entered using the Keypad and write the result to the device.
	To perform the arithmetic operation and display the result, add 1 to the value of device and display the result.
[LDR0] + @ + 100	To perform the arithmetic operation and input the result, add the value of LDR0 to the value entered using the Keypad and add 100, and write the result to the device.
	To perform the arithmetic operation and display the result, add the value of LDR0 to the value of device and add 100, then display the result.
@ & 3	To perform the arithmetic operation and input the result, write the logical AND operation of the value entered using the Keypad and 3 to the device.
	To perform the arithmetic operation and display the result, a logical AND operation of the value of device and 3 is displayed.

● Comment Tab

The **Comment** tab is used to specify the parts arranged on the editing screen, and the popup text displayed when the mouse pointer is placed close to **No.**, **Name**, or **Type** in the object list.



When there are multiple parts of the same shape on the screen, this feature makes it possible to distinguish between the parts without displaying the Properties dialog box for each part, by just mousing over the part.

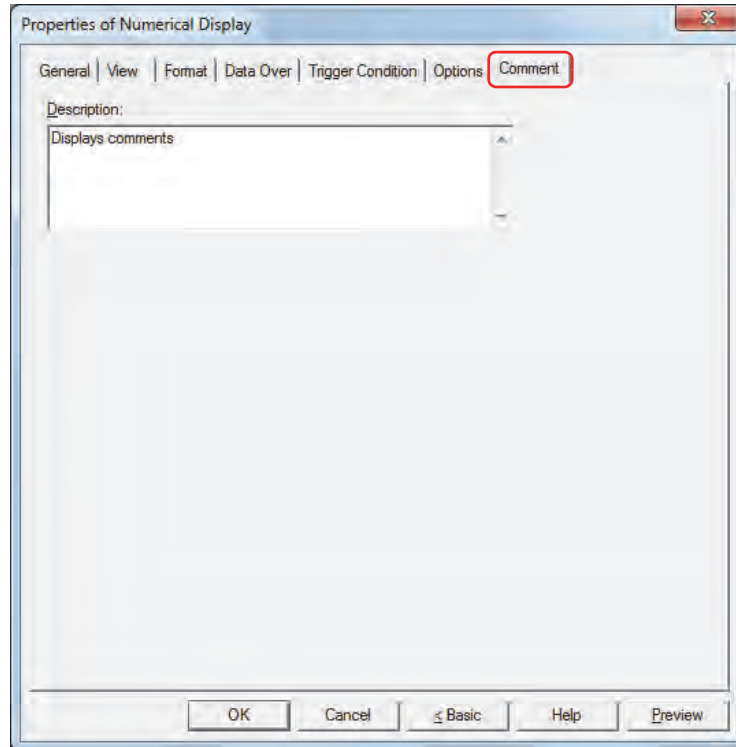

■ Description

Enter a comment about parts. The maximum number is 80 characters.

Example: When mousing over the Numerical Display on the editing screen



9 Calendar

9.1 How the Calendar is Used

The Calendar can be used to display the date and time using the Touch's clock data.

- Display the date and time

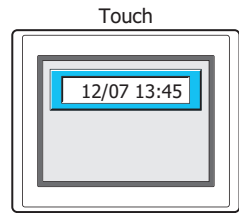

- Write 0 or 1 to a device at the configured times

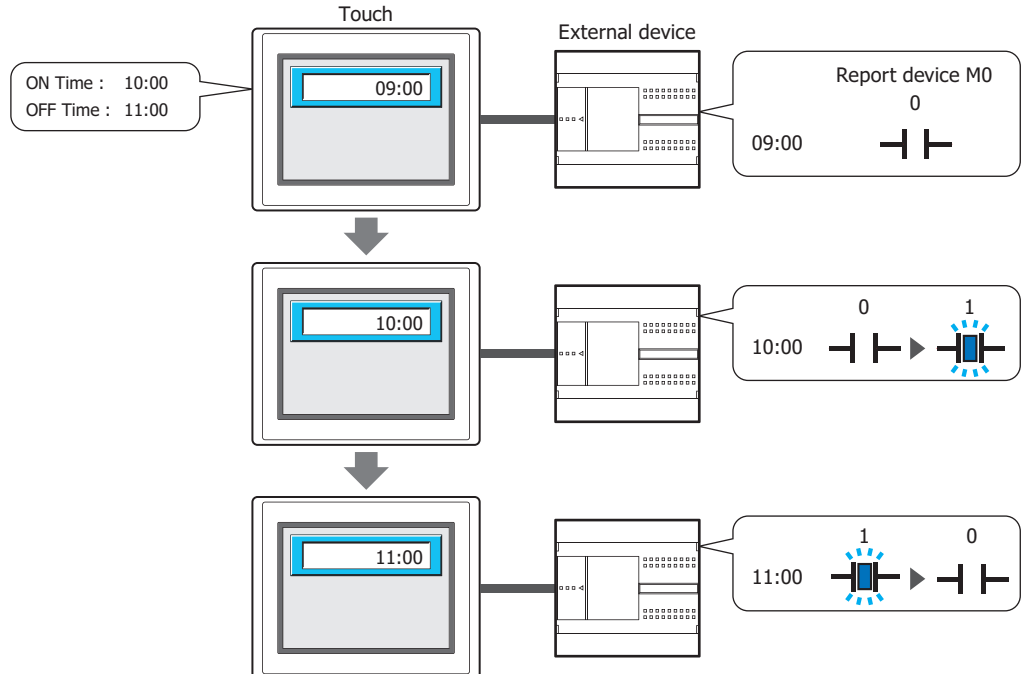

	ON Time		OFF Time		
Time	09:00	09:30	10:00	10:30	11:00
Action			Write		Write
Value of Report Device M0	0	0	1	1	0

 When **Alarm** is selected for **Calendar Type**, you can use just the alarm function without displaying the clock on the screen.

9.2 Calendar Configuration Procedure

This section describes the configuration procedure for Calendars.

- 1 On the **Home** tab, in the **Parts** group, click **Data Displays**, and then click **Calendar**.

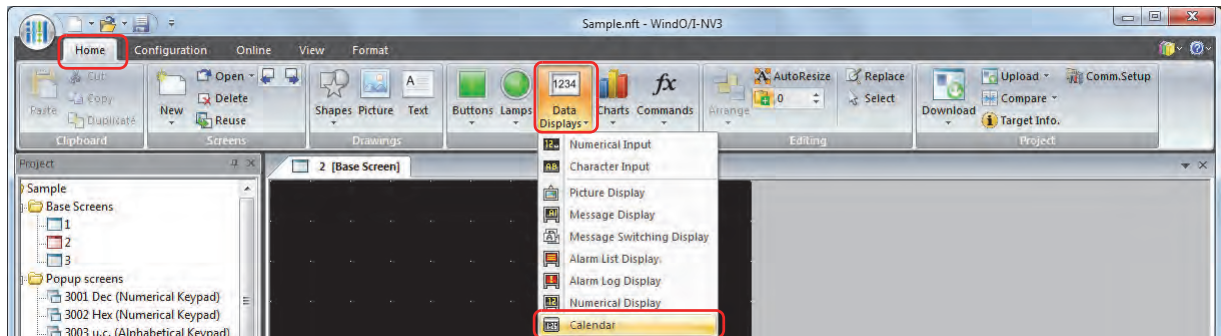

- 2 Click a point on the edit screen where you want to place the Calendar.
- 3 Double-click the dropped Calendar and a Properties dialog box will be displayed.
- 4 Change the settings on each tab as necessary.

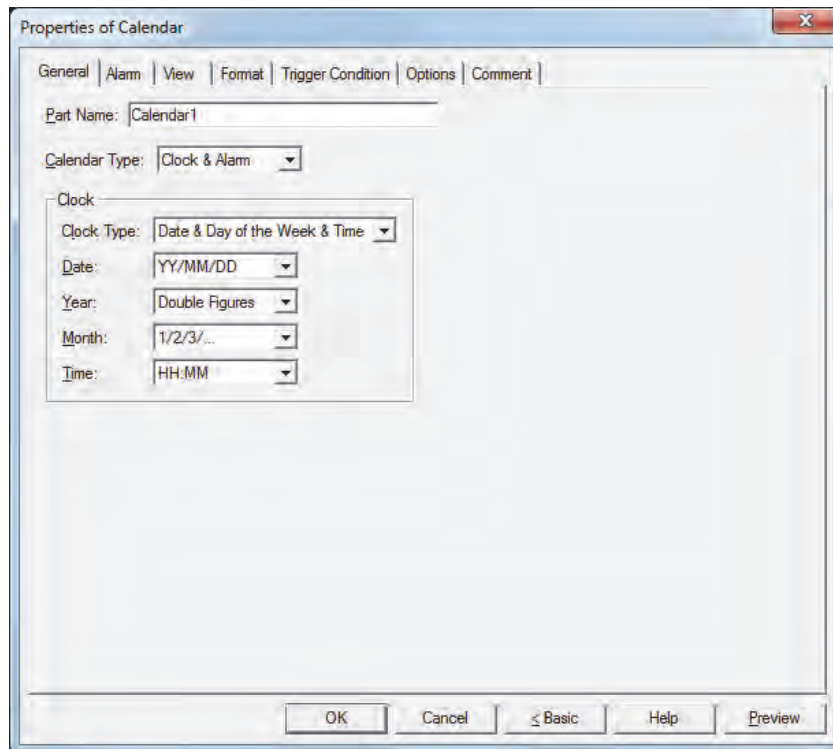

The **Trigger Condition** tab and **Options** tab only appear in Advanced mode. To switch to Advanced mode, click **Advanced**.

9.3 Properties of Calendar Dialog Box

This section describes items and buttons on the properties dialog box.

● General Tab

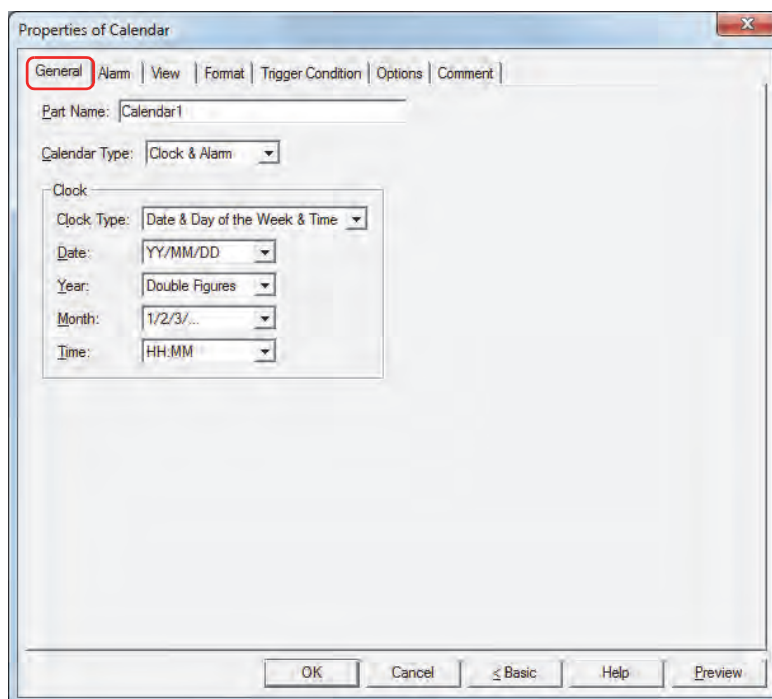

■ Part Name

Enter a name for the part. The maximum number is 20 characters.

■ Calendar Type

Selects the type of Calendar from the following.

Clock: Displays the date and time.

Alarm: Notifies by writing 1 (ON Time) or 0 (OFF Time) to a device at the configured times without displaying the clock.

Clock & Alarm: Displays the clock and notifies by writing 1 (ON Time) or 0 (OFF Time) to a device at the configured times.

■ Clock

These options configure the type and format of the clock. These options can only be configured when **Clock** or **Clock & Alarm** is selected for **Calendar Type**.

Clock Type: Selects the items to display for the clock from the following.
Time, Day of the Week & Time, Date & Time, Date & Day of the Week & Time

Date: Selects the display type of the date from the following.
YY/MM/DD, MM/DD/YY, DD/MM/YY, MM/DD, DD/MM
This option can only be configured when **Date & Time** or **Date & Day of the Week & Time** is selected for **Clock Type**.

Year: Selects the display type for the year as **Double Figures** or **Four Figures**.
This option can only be configured when **Date & Time** or **Date & Day of the Week & Time** is selected for **Clock Type**.

Month: Selects the display type for the month as **1/2/3/...** or **Jan/Feb/Mar/...**.
This option can only be configured when **Date & Time** or **Date & Day of the Week & Time** is selected for **Clock Type**.

Time: Selects the display type for the time as **HH:MM** or **HH:MM:SS**.
HH: hours, MM: minutes, SS: seconds

● Alarm Tab

These options can only be configured when **Alarm** or **Clock & Alarm** is selected for **Calendar Type** on the **General** tab.

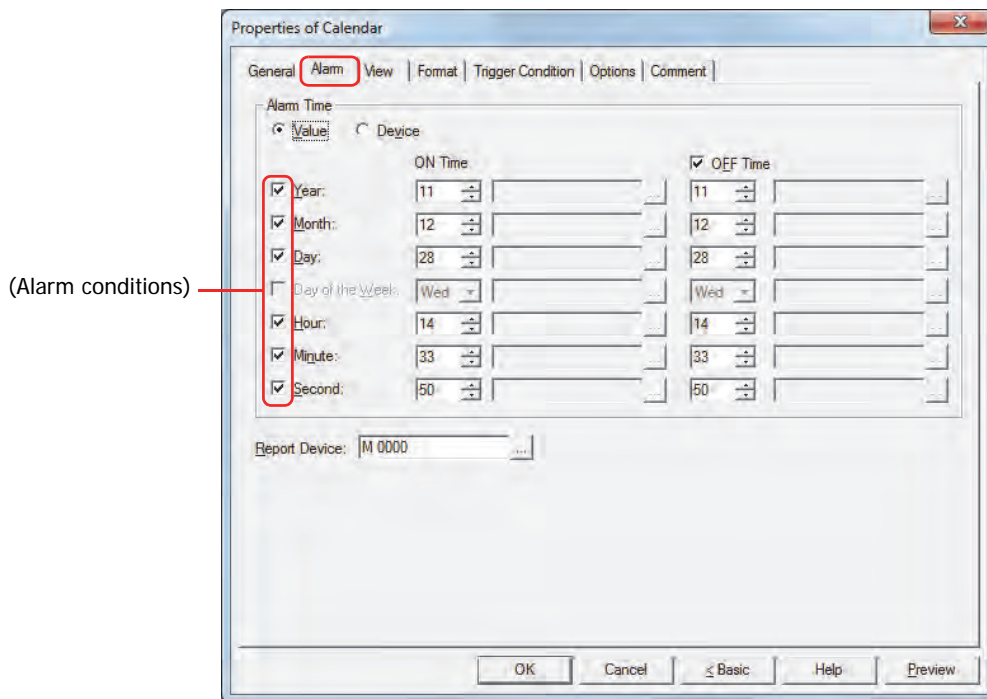

■ Alarm Time

Selects the type of data for the alarm time.

Value: Specifies the alarm time as values and the day of the week.

Year: Enter the year (0 to 99).

Month: Enter the month (1 to 12).

Day: Enter the day (1 to 31).

Day of the Week: Select the day of the week.

Hour: Enter the hour (0 to 23).

Minute: Enter the minute (0 to 59).

Second: Enter the second (0 to 59).

Device: Configures the alarm time as values of word device.

Click to display the Device Address Settings dialog box. For the device address configuration procedure, refer to Chapter 2 "5.1 Device Address Settings" on page 2-61.

■ (Alarm conditions)

Select the check boxes for the conditions to use as the alarm time.

The **Day of the Week** check box can only be configured when the **Year** check box is cleared.

■ **ON Time**

Configures the time to write 1 to the report device according to the type of data.



- After 1 is written to the report time with **ON Time**, that value is retained.

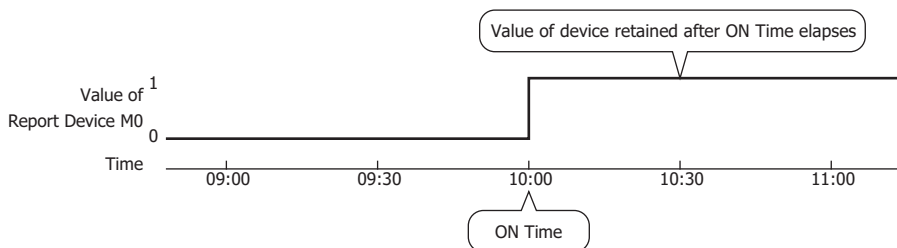

- After a screen configured with the Calendar is displayed, if the time is in between **ON Time** and **OFF Time**, 1 is written to the report device.

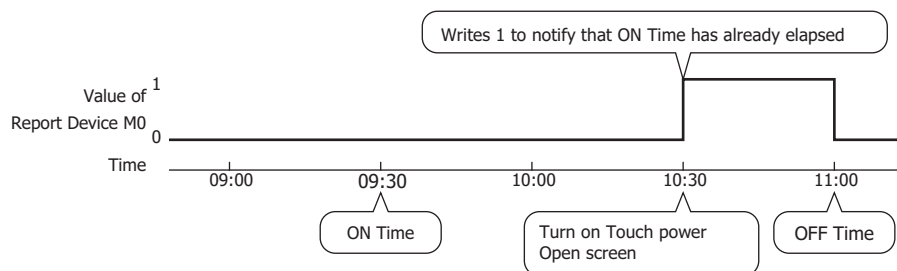

■ **OFF Time**

Select this check box to configure the time to write 0 to the report device. The time is configured according to the type of data.



- The value of Report Device is retained even when the current time exceeds **OFF Time**.

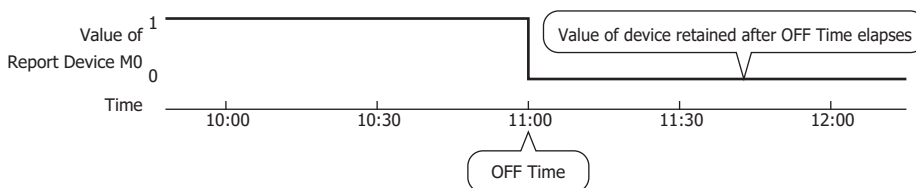

- After a screen configured with the Calendar is displayed, if the time exceeds **OFF Time**, 0 is written to the report device.

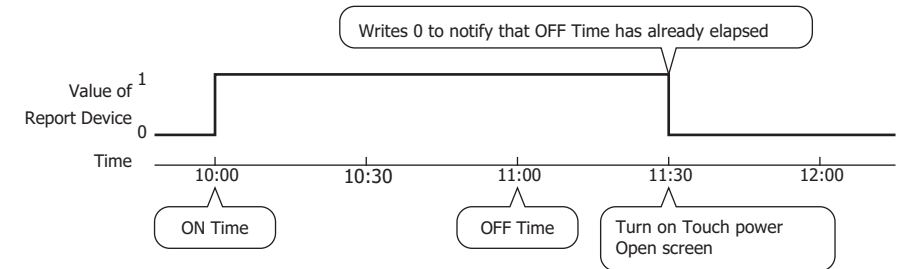

■ **Report Device**

Specifies the bit device to write the value to at **ON Time** and **OFF Time**.

Click  to display the Device Address Settings dialog box. For the device address configuration procedure, refer to Chapter 2 "5.1 Device Address Settings" on page 2-61.

● View Tab

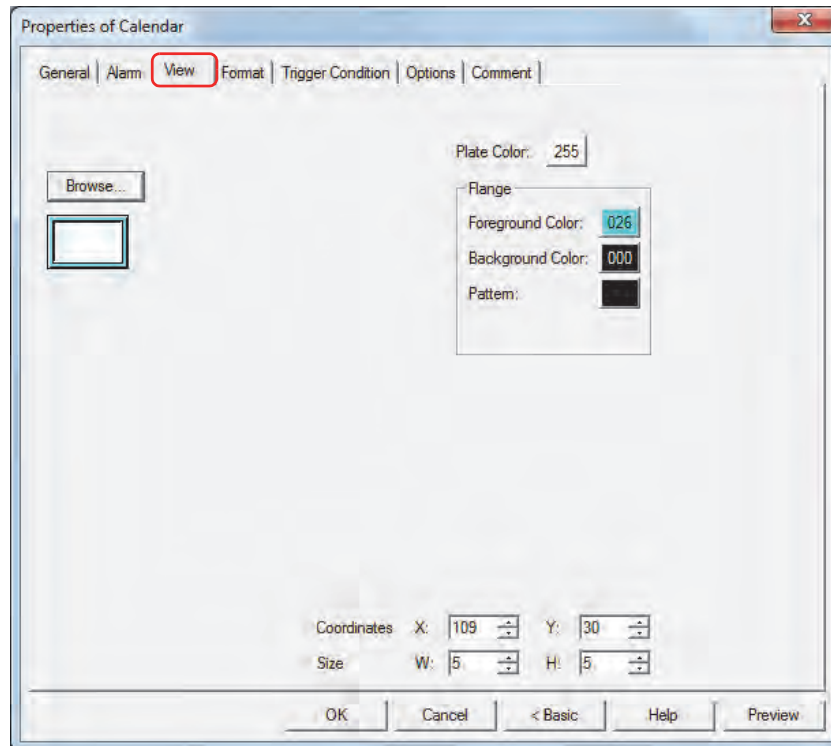

■ Browse

Select the type of graphic to represent the part from the list of graphics. Click this button to display the View Browser.

■ Plate Color

Selects the plate color of the standard graphic (color: 256 colors, monochrome: 8 shades).

Click the **Color** button to display the Color Palette. Select a color from the Color Palette.

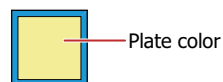

■ Flange

Foreground Color, Background Color:

Selects the foreground and background colors of the flange of the standard graphic (color: 256 colors, monochrome: 8 shades).

Click the **Color** button to display the Color Palette. Select a color from the Color Palette.

Pattern:

Selects a pattern for the flange of the standard graphic.

Click the **Pattern** button to display the Pattern Palette. Select a pattern from the Pattern Palette.



■ Coordinates

- X, Y: Sets the display position of parts using coordinates.
The X and Y coordinates of parts is defined relative to an origin at the top-left corner of the screen.
- X: 0 to (Base Screen horizontal size - 1)
- Y: 0 to (Base Screen vertical size - 1)

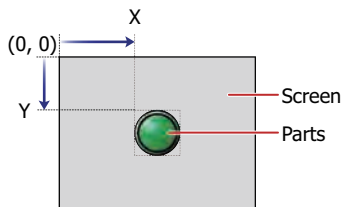

■ Size

- W, H: Sets width and height to define the size of parts.
- W: 5 to (Base Screen horizontal size)
- H: 5 to (Base Screen vertical size)

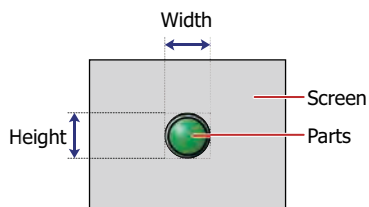

● Format Tab

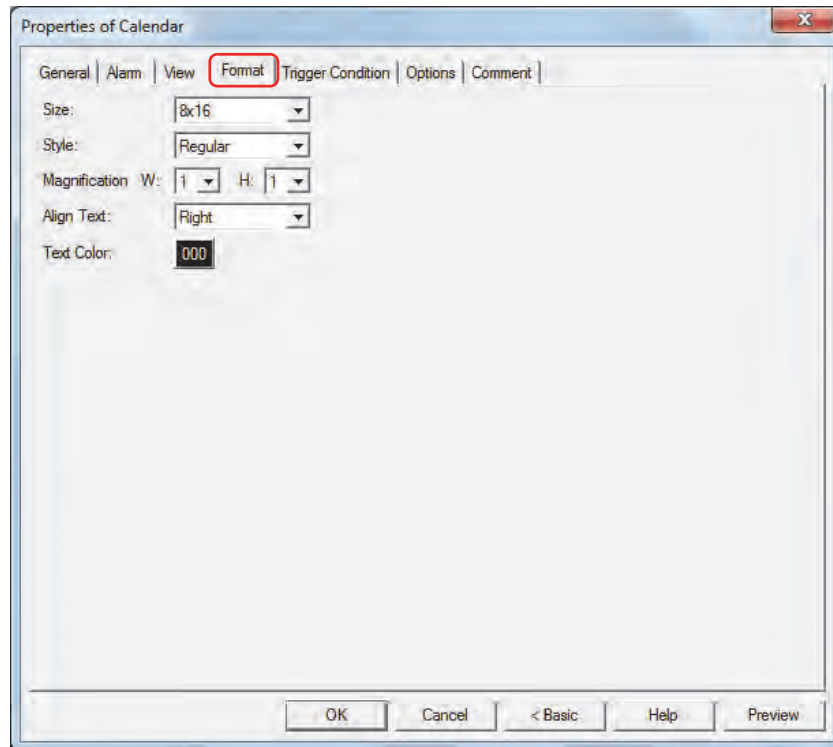

■ Size

Selects the text size as **8x16** or **16x16**.

■ Style

Selects **Regular** or **Bold** for text style.

■ Magnification

W, H: Selects text magnification (0.5, 1 to 8).

■ Align Text

Selects the text alignment in the horizontal direction from the following.

Left, Center, Right

For details, refer to Appendix "5 Text Alignment" on page A-5.

■ Text Color

Selects the color of displayed text (color: 256 colors, monochrome: 8 shades).

Click the **Color** button to display the Color Palette. Select a color from the Color Palette.

● **Trigger Condition** Tab

The **Trigger Condition** tab is displayed in Advanced mode.

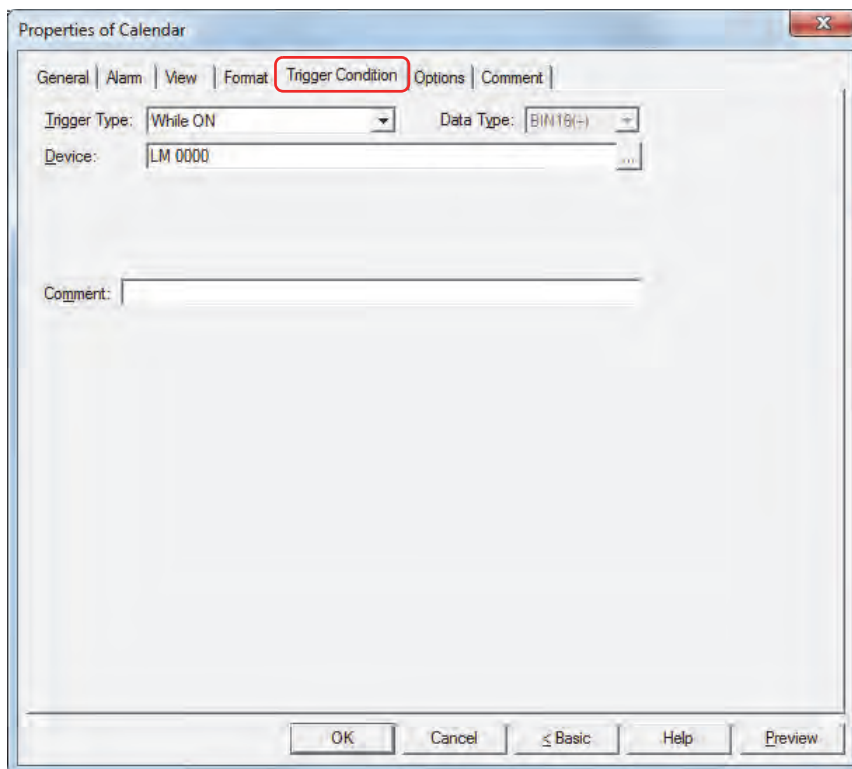

The Calendar is enabled while the condition is satisfied, and it is disabled while the condition is not satisfied. When disabled, the plate and flange are displayed, but the time is not displayed.

Example: When **Trigger Type** is **While ON**, **Device** is LMO

While LMO is 0, the condition is not satisfied and the Calendar does not display the time.

While LMO is 1, the condition is satisfied and the Calendar displays the time.

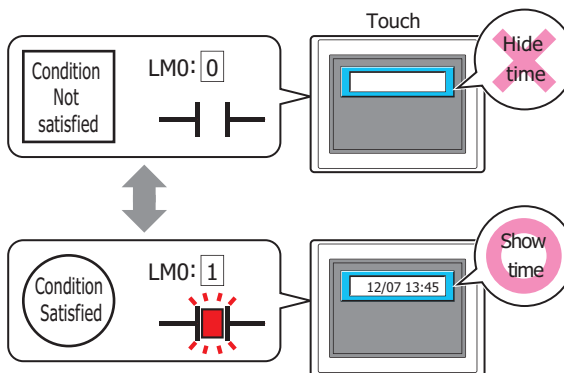

■ **Trigger Type**

Selects the condition to enable the Calendar from the following.

Always Enabled: The Calendar is always enabled.

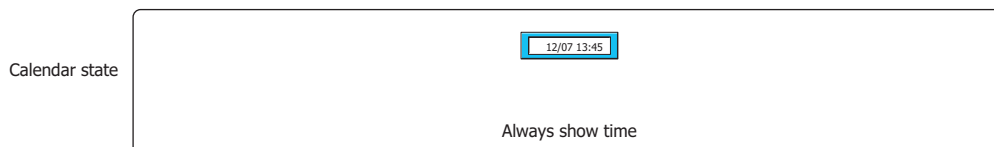

While ON: Enables the Calendar when the value of device is 1.

Example: When the **Not show Calendar** check box is cleared under **While not satisfying the condition**

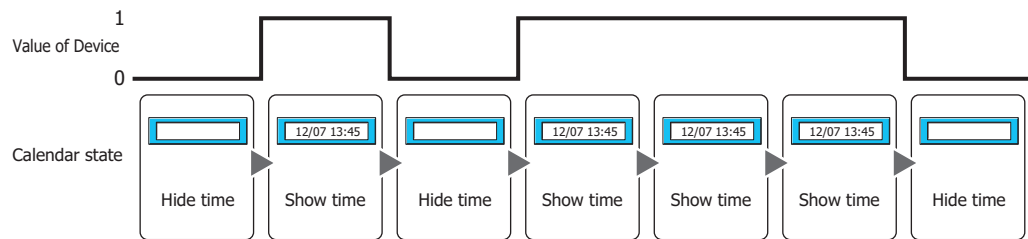

While OFF: Enables the Calendar when the value of device is 0.

Example: When the **Not show Calendar** check box is cleared under **While not satisfying the condition**

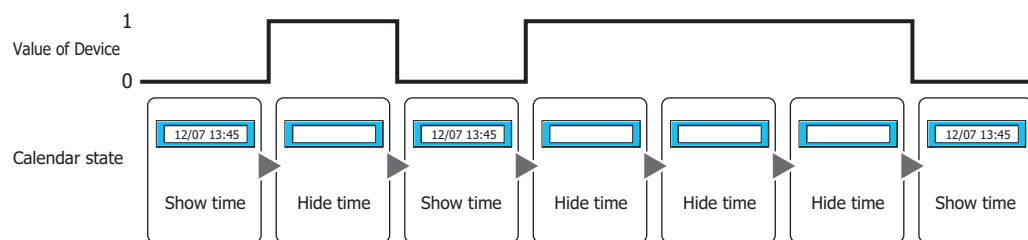

While satisfying the condition:

Enables the Calendar when the condition is satisfied.

Example: When the **Not show Calendar** check box is cleared under **While not satisfying the condition**

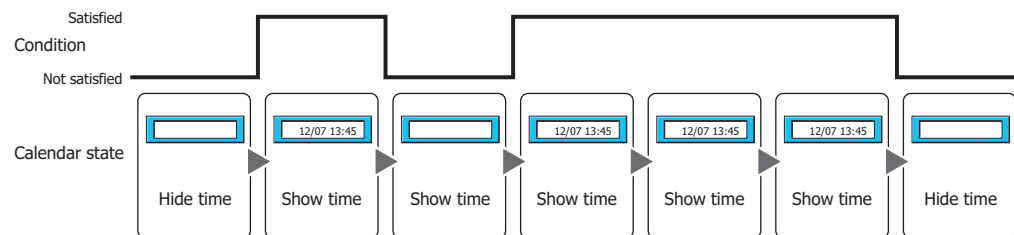

■ Data Type

Selects the data type handled by the condition formula.

Can only be set if **While satisfying the condition** is selected as **Trigger Type**.

For details, refer to Chapter 2 "1.1 Available Data" on page 2-1.

■ Device

Specifies the bit device or bit of the word device to serve as condition.

Can only be set if **While ON** or **While OFF** is selected as **Trigger Type**.

Click to display the Device Address Settings dialog box. For the device address configuration procedure, refer to Chapter 2 "5.1 Device Address Settings" on page 2-61.

■ Condition

Sets the condition formula.

Can only be set if **While satisfying the condition** is selected as **Trigger Type**.

Click to display the Trigger Condition Settings dialog box. For the conditional expression configuration procedure, refer to Chapter 2 "5.2 Setting Conditional Expressions" on page 2-63.

■ Comment

Enter a comment about trigger conditions. The maximum number is 80 characters.

● Options Tab

The **Options** tab is displayed in Advanced mode.

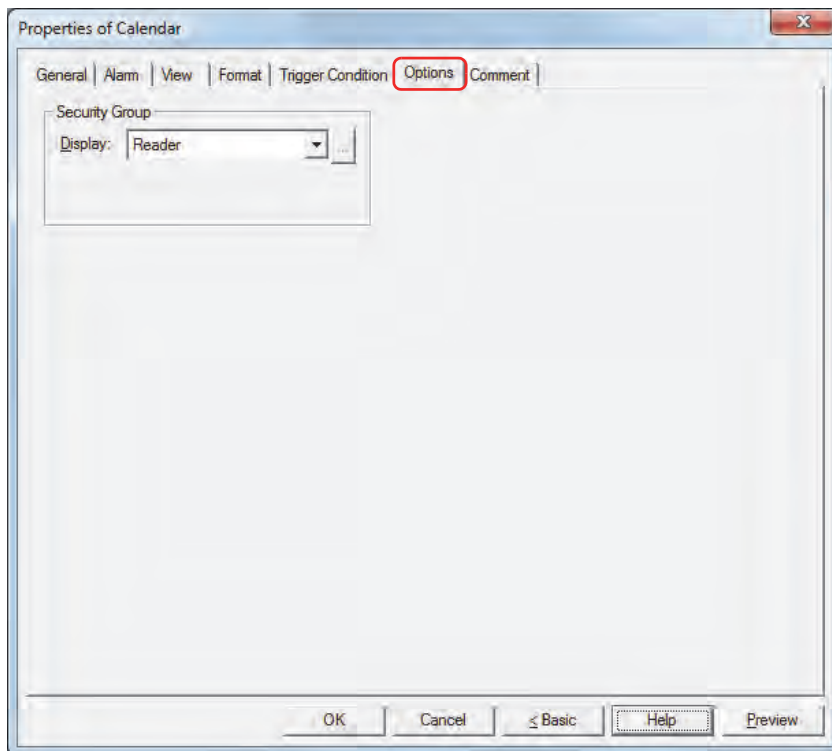

■ Security Group

Security groups are a security function for restricting the display and operation of parts.

Display: Selects the security group for which display of parts is restricted. (Default: None)

None: No security function is used.



Administrator, Operator, Reader: Three security groups are set up by default.

Click  to display the Security Group Settings dialog box. If you create a security group on the Security Group Settings dialog box, you can select that created group. For details, refer to Chapter 21 "2.2 Adding and Editing Security Groups" on page 21-15.



For details about security functions, refer to Chapter 21 "User Accounts and the Security Function" on page 21-1.

Example: If the user and security group for a part are set as follows:

User Name	 User1	 User2
Security Group	None	Group A

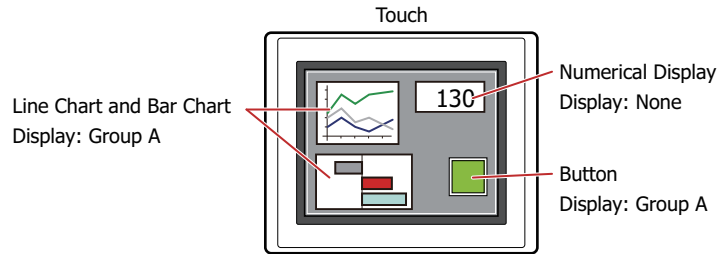

For User 1, who is not included in the specified security group, Group A parts are not displayed.

If the Password Screen is now opened and a switch is made to User 2 of Group A, Group A parts are displayed.

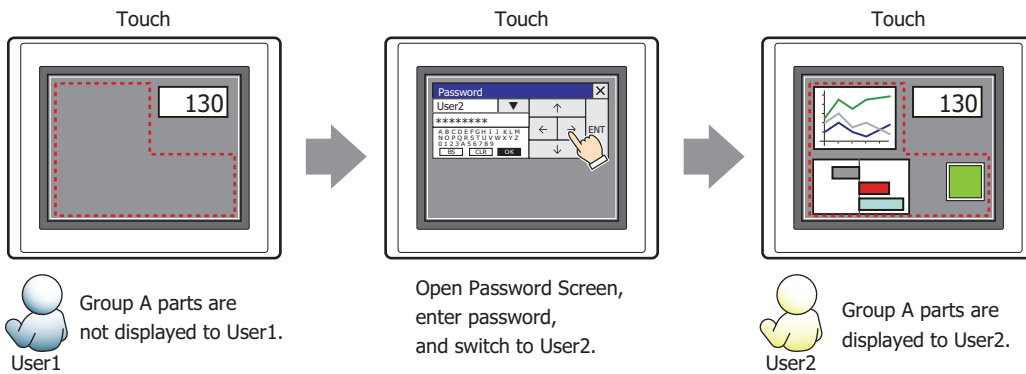

● **Comment Tab**

The **Comment** tab is used to specify the parts arranged on the editing screen, and the popup text displayed when the mouse pointer is placed close to **No.**, **Name**, or **Type** in the object list.



When there are multiple parts of the same shape on the screen, this features makes it possible to distinguish between the parts without displaying the Properties dialog box for each part, by just mousing over the part.

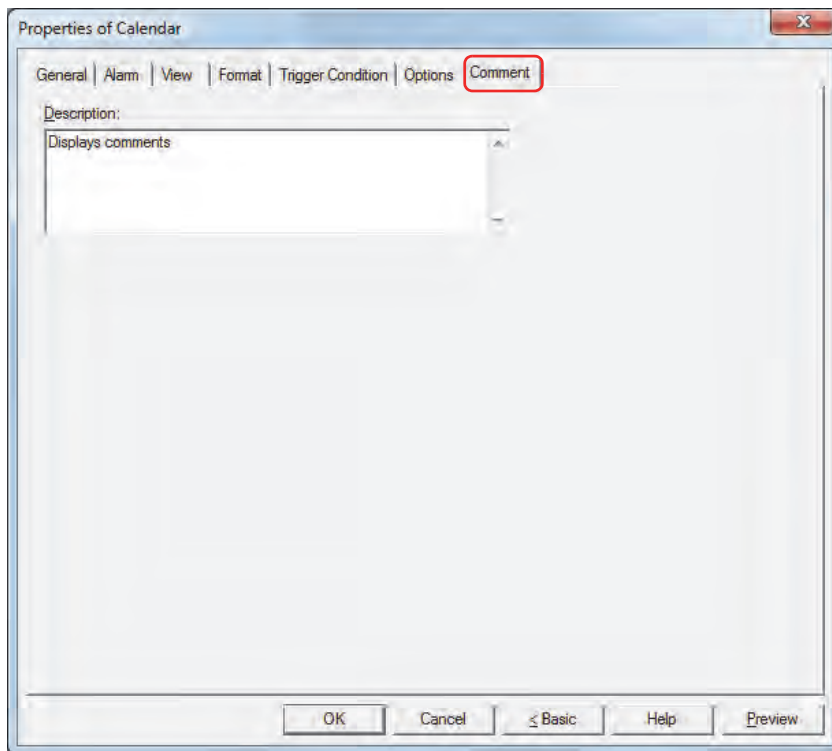

■ **Description**

Enter a comment about parts. The maximum number is 80 characters.
 Example: When mousing over the Calendar on the editing screen

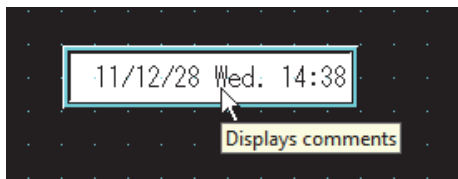

Chapter 10 Charts

This chapter describes how to configure charts and meters and their operation on the Touch.

1 Bar Chart

1.1 How the Bar Chart is Used

Bar charts and peak charts can be used to display values of word devices.

- Display values of word devices in a bar chart

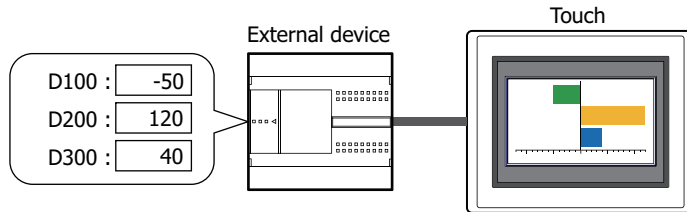

- Display values of word devices in a peak chart

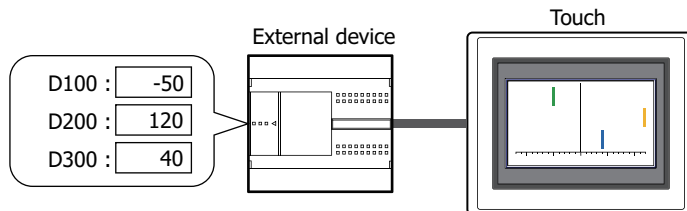

- Make the chart blink when the displayed data exceeds the maximum or minimum

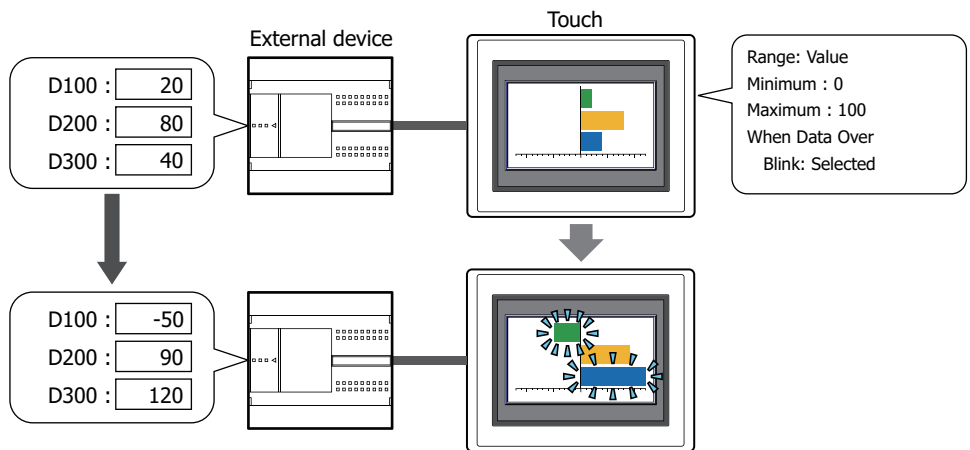

1.2 Bar Chart Configuration Procedure

This section describes the configuration procedure for bar charts.

- 1 On the **Home** tab, in the **Parts** group, click **Charts**, and then click **Bar Chart**.

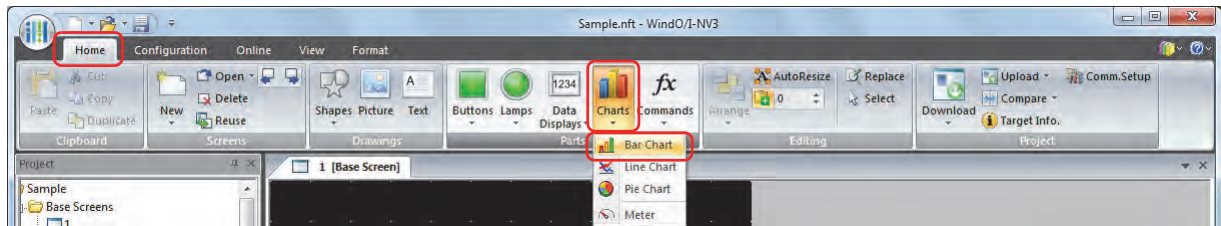

- 2 Click a point on the edit screen where you want to place the Bar Chart.
- 3 Double-click the dropped Bar Chart and a Properties dialog box will be displayed.
- 4 Change the settings on each tab as necessary.

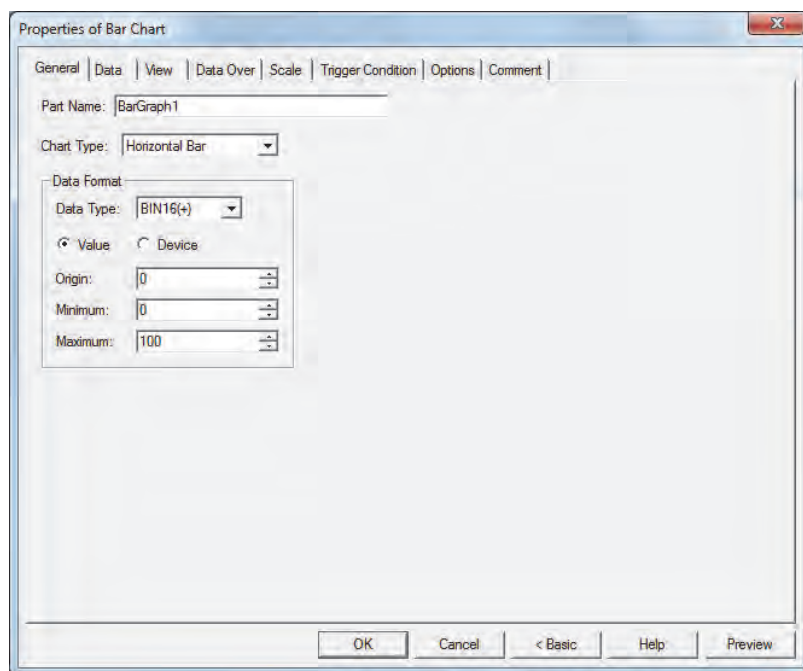

The **Data Over** tab, **Scale** tab, **Trigger Condition** tab and **Options** tab only appear in Advanced mode. To switch to Advanced mode, click **Advanced**.

1.3 Properties of Bar Chart Dialog Box

This section describes items and buttons in the Properties dialog box.

● General Tab

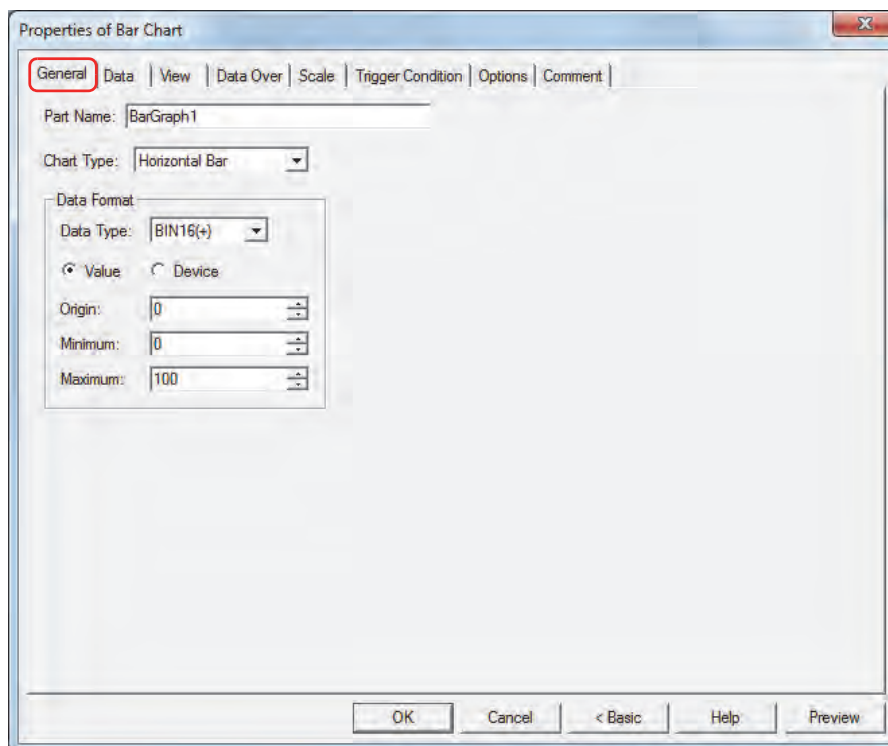

■ Part Name

Enter a name for the part. The maximum number is 20 characters.

■ Chart Type

Selects the type of chart from the following items.

Horizontal Bar, Vertical Bar, Horizontal Peak, Vertical Peak

Peak charts only display the tip of the bar chart.

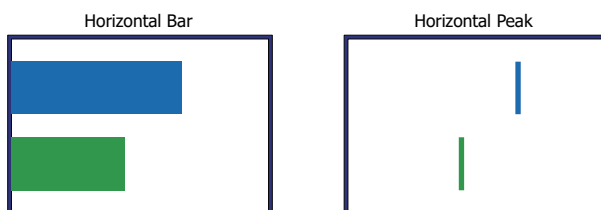

■ Data Format

- Data Type: Selects the data type handled by the chart.
For details, refer to Chapter 2 "1.1 Available Data" on page 2-1.
- (Data Type) *1: Selects the type of data used for entering values in **Origin**, **Minimum**, and **Maximum**.
- Value: Uses a constant.
- Device: Uses a word device.
- Origin, Minimum, Maximum: Specifies the origin, minimum, and maximum for the chart.
The origin, minimum, and maximum that can be specified during Basic mode and when **Value** is selected vary based on the data type. For details, refer to Chapter 2 "1.1 Available Data" on page 2-1.
When **Device** is selected, these options specify the source word devices.
Click to display the Device Address Settings dialog box. For the device address configuration procedure, refer to Chapter 2 "5.1 Device Address Settings" on page 2-61.



If the data displayed in the chart is invalid, 1 is written to System Area 2 Arithmetic error bit (address+2, bit 5), and an error message is displayed. For details, refer to Chapter 3 "Arithmetic error" on page 3-25.
Invalid data is as follows.

- When the minimum is the same as or larger than the maximum
- When the source data includes A through F if **Data Type** is **BCD4** or **BCD8**

*1 Advanced mode only

● Data Tab

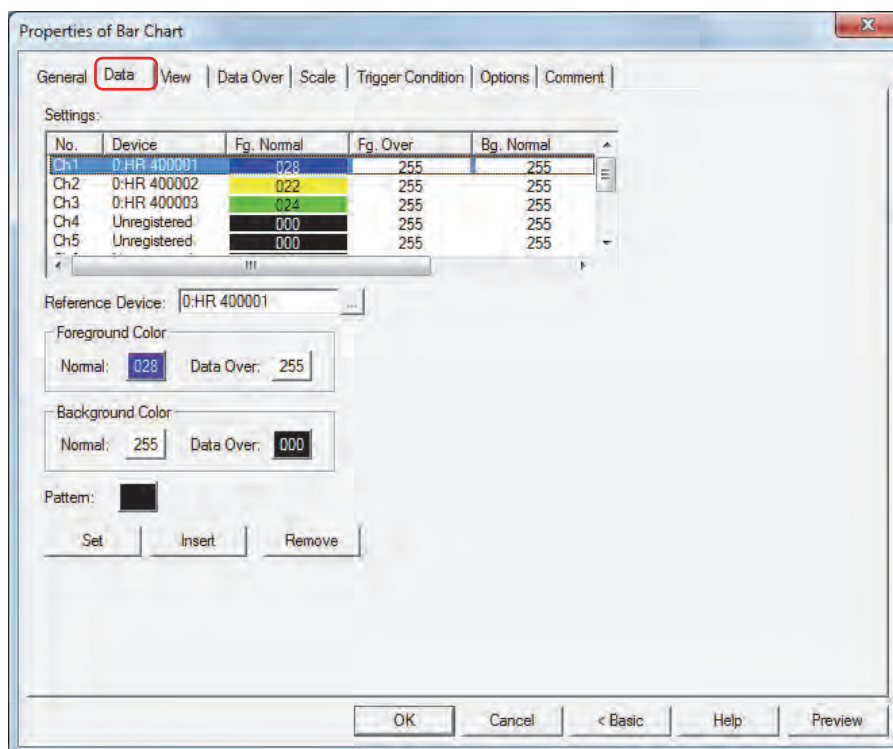

■ Settings

Lists the chart settings. The list shows the numbers, reference devices, and colors for the chart.

No.:

Shows the numbers for the chart (Ch1 to Ch10).

For **Horizontal Bar** and **Horizontal Peak**, the numbers are listed in order from top. For **Vertical Bar** and **Vertical Peak**, the numbers are listed in order from the left.

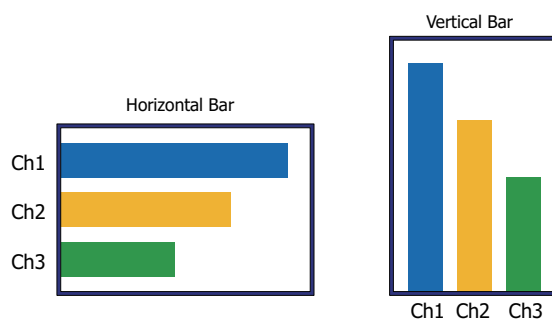

Device:

Shows the source word device for the data to display in the chart.

Fg. Normal:

Shows the foreground color of the chart when normal.

Fg. Over*1:

Shows the foreground color of the chart when data over.

Bg. Normal:

Shows the background color of the chart when normal.

Bg. Over*1:

Shows the background color of the chart when data over.

Pattern:

Shows the chart pattern.

*1 Advanced mode only

■ Reference Device

Specifies the source word device for the data to display in the chart.

Click  to display the Device Address Settings dialog box. For the device address configuration procedure, refer to Chapter 2 "5.1 Device Address Settings" on page 2-61.

■ Foreground Color

Normal, Data Over^{*1}: Selects the foreground color for the chart when normal and when data over (color: 256 colors, monochrome: 8 shades).

Click either button to display the Color Palette. Select a color from the Color Palette.

■ Background Color

Normal, Data Over^{*1}: Selects the background color for the chart when normal and when data over (color: 256 colors, monochrome: 8 shades).

Click either button to display the Color Palette. Select a color from the Color Palette.

■ Pattern

Selects the chart pattern.

Click this button to display the Pattern Palette. Select a pattern from the Pattern Palette.

■ Set

Registers the chart settings to the list. If you select a Ch number that is already registered, that number is overwritten with the new settings.

Select a Ch number on the list, and then click this button to register the **Reference Device**, **Foreground Color**, **Background Color**, and **Pattern** settings.

■ Insert

Inserts the chart settings in the position selected on the list.

Select a Ch number on the list, and then click this button to insert the **Reference Device**, **Foreground Color**, **Background Color**, and **Pattern** settings. The settings at the insertion point shift down one line. Settings cannot be inserted if all Ch numbers are configured.

■ Remove

Deletes the registered settings from the list.

Select a Ch number, and then click this button to delete the selected settings from the list.

*1 Advanced mode only

● View Tab

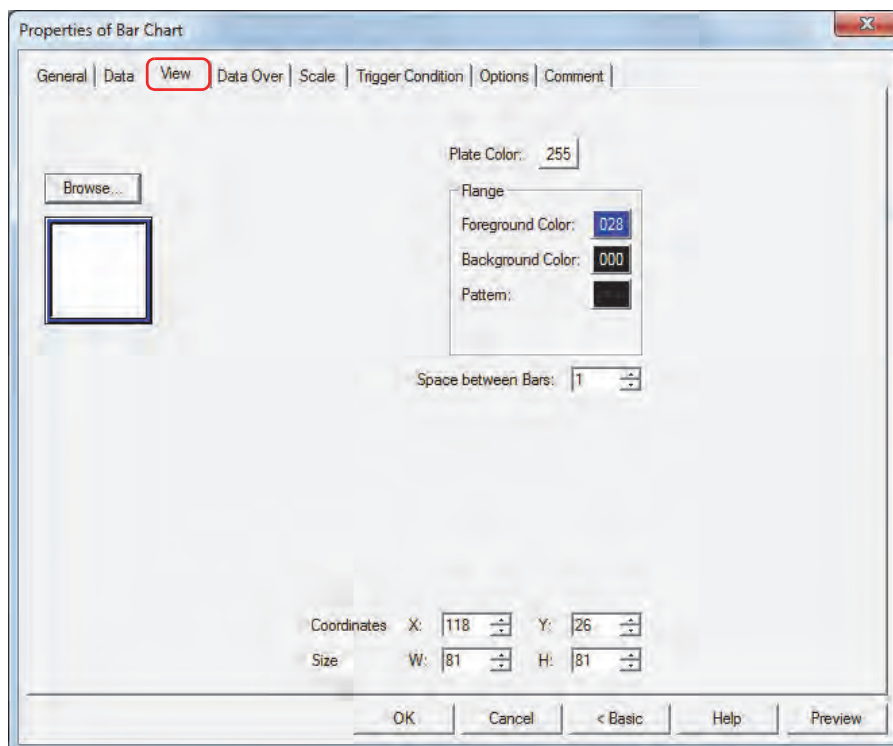

■ Browse

Select the type of graphic to be used to represent the part from the list of graphics. Click this button to display the View Browser.

■ Plate Color

Selects the plate (color: 256 colors, monochrome: 8 shades).

Click the **Color** button to display the Color Palette. Select a color from the Color Palette.

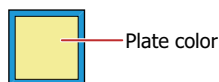

■ Flange

Foreground Color, Background Color:

Selects the foreground and background colors of the flange (color: 256 colors, monochrome: 8 shades).

Click the **Color** button to display the Color Palette. Select a color from the Color Palette.

Pattern:

Selects a pattern for the flange.

Click the **Pattern** button to open the Pattern Palette. Select a pattern from the Pattern Palette.

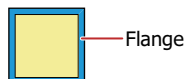

■ **Space between Bars**^{*1}

Specifies the spacing for the bar chart (0 to 100 dots).

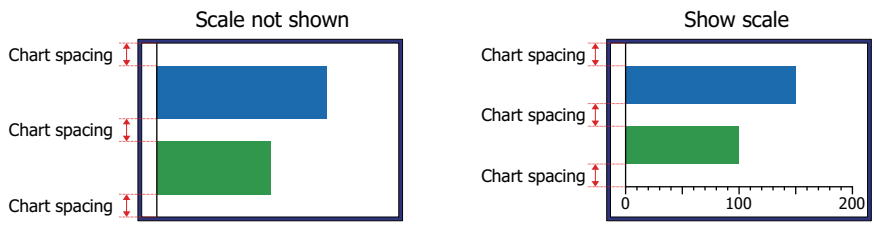

Example: If **Space between Bars** is 10

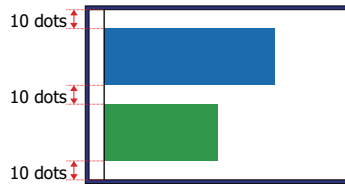

If **Space between Bars** is 0



■ **Coordinates**

X, Y: Sets the display position of parts using coordinates.

The X and Y coordinates of parts are defined relative to an origin at the top-left corner of the screen.

X: 0 to (Base Screen horizontal size - 1)

Y: 0 to (Base Screen vertical size - 1)

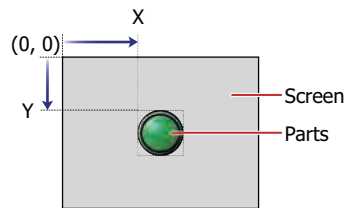

■ **Size**

W, H: Sets width and height to define the size of parts.

W: 5 to (Base Screen horizontal size)

H: 5 to (Base Screen vertical size)

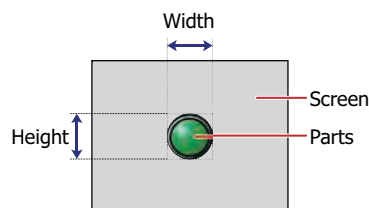

*1 Advanced mode only

● Data Over Tab

The **Data Over** tab is displayed in Advanced mode.

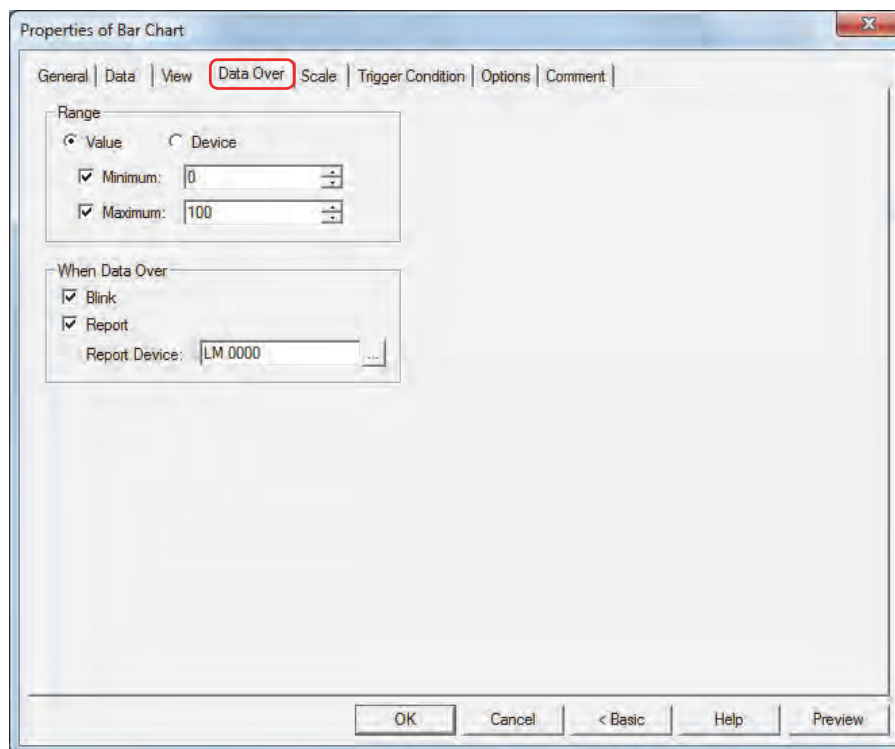

■ Range

Select data type.

Value: Specifies the minimum and/or the maximum as a constant.

Device: Specifies the minimum and/or the maximum as a value of word device.

Specifies the allowable range of values to display.

Minimum, Maximum: Select these check boxes to specify the minimum and/or maximum.

The minimum and maximum that can be specified when **Value** is selected vary based on the data type selected with **Data Format** on the **General** tab. For details on data types, refer to Chapter 2 "1.1 Available Data" on page 2-1.

When **Device** is selected, these options specify the source word devices.

Click to display the Device Address Settings dialog box. For the device address configuration procedure, refer to Chapter 2 "5.1 Device Address Settings" on page 2-61.

■ **When Data Over**

These options configure the operation of the part when the allowable range is exceeded.

These options can only be configured when the **Minimum** or **Maximum** check boxes are selected under **Range**.

Blink: Select this check box to make the chart blink when the displayed data exceeds the allowable range.

Report: Select this check box to write 1 in the report device when the displayed data exceeds the allowable range.

Report Device: Specifies the report device.

Click  to display the Device Address Settings dialog box. For the device address configuration procedure, refer to Chapter 2 "5.1 Device Address Settings" on page 2-61.

Example: If the value of word device of the reading source is "110," which is higher than the upper limit of "100," or "-10," which is below the lower limit of "0," a value of 1 will be written to LM0 and the displayed bar will blink.

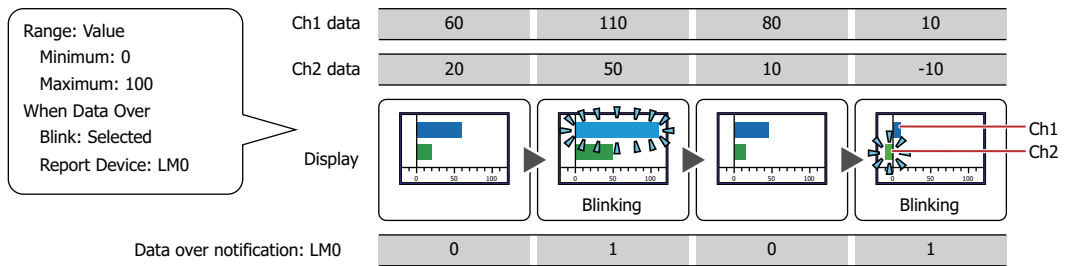

● Scale Tab

The **Scale** tab is displayed in Advanced mode.

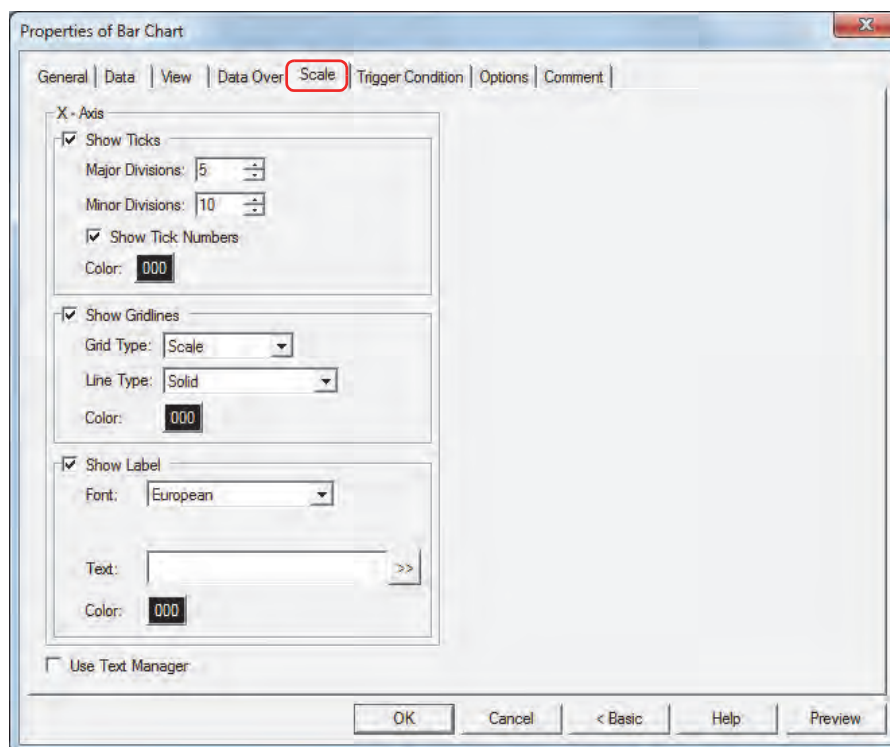

The options on the **Scale** tab vary based on the type selected with **Chart Type** on the **General** tab.

Horizontal Bar, Horizontal Peak: X-Axis

Vertical Bar, Vertical Peak: Y-Axis

■ Show Ticks

Select this check box to display a scale on a chart.

Major Divisions: Enter the number of major scale divisions (1 to 20).

Minor Divisions: Enter the number of minor scale divisions (1 to 20).

Show Tick Numbers: Select this check box to display numbers along the scale. The values are displayed in the same color as the scale.

This can only be set if **Value** is selected for **Data Format** under the **General** tab.

Color: Selects the color of scales (color: 256 colors, monochrome: 8 shades).

Click the **Color** button to display the Color Palette. Select a color from the Color Palette.



If the area for displaying the scale is small, the scale will not be displayed properly.

■ Show Gridline

Select this check box to display grid lines on the chart. Grid lines are displayed above the chart.

Display Position: Select from **Scale** and **Data Over** to specify the grid line display position.

Scale: Grid lines are displayed according to the number of major scale divisions. Can only be set when the **Show Ticks** check box is selected.

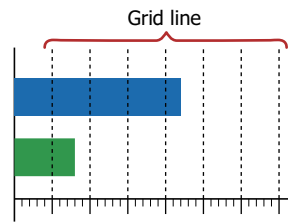

Data Over: Grid lines are displayed at the positions of values specified for **Maximum** and **Minimum** under the **Data Over** tab. This option can only be configured when **Data Format** on the **General** tab and **Range** on the **Data Over** tab are set to **Value**.

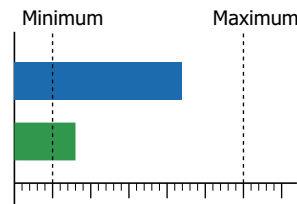

Line Type: Selects the type of grid lines from the following.

Solid, Dot, Dash, Long Dash, Long Dash Dot, Long Dash Dot Dot

Color: Specifies grid line color (color: 256 colors, monochrome: 8 shades). Click the **Color** button to display the Color Palette. Select a color from the Color Palette.

■ Show Label

Select this check box to display labels on the scale.

Font: Selects the font for text used in labels from the following. **Japanese, European, Chinese, Taiwanese, Korean, Central European, Baltic, Cyrillic**. Can only be set when the **Use Text Manager** check box is cleared. The characters that can be displayed depend on the font. For details, refer to Chapter 2 "1.2 Available Text" on page 2-5.

Text ID: Specifies the Text Manager ID No. (1 to 32,000) when text registered in Text Manager are used for labels.

Click to display Text Manager.

Can only be set when the **Use Text Manager** check box is selected.

Text: Inputs characters to be displayed for labels. The maximum number is 40 characters. The characters that can be entered depend on the font selected using **Font**. For details, refer to Chapter 2 "1.2 Available Text" on page 2-5.

Can only be input when the **Use Text Manager** check box is cleared.



When entering Unicode characters click to display the Unicode Input dialog box. Enter the characters using the Unicode Input dialog box then click **OK**.

Color: Selects the color of the text used for labels (color: 256 colors, monochrome: 8 shades). Click the **Color** button to display the Color Palette. Select a color from the Color Palette.

■ Use Text Manager

Select this check box if using the text registered in Text Manager for labels.



If a carriage return (CR) is included, the characters after the CR are not displayed. However, if Windows Font is set for the specified Text ID, all the characters are displayed.

● **Trigger Condition** Tab

The **Trigger Condition** tab is displayed in Advanced mode.

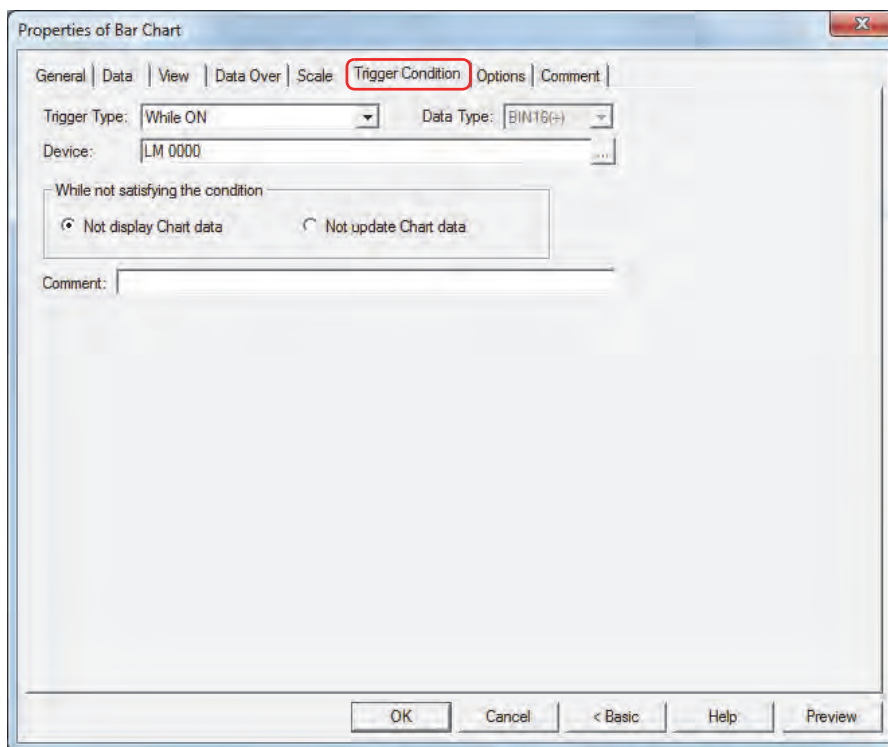

The bar chart is enabled while the condition is satisfied, and it is disabled while the condition is not satisfied. Select the operation when the condition is not satisfied as **Not display Chart data** or **Not update Chart data** under **While not satisfying the condition**.

Example: When **Trigger Type** is **While ON**, **Device** is LMO, and **While not satisfying the condition** is **Not display Chart data**
 While LMO is 0, the condition is not satisfied and the bar chart is not displayed.
 While LMO is 1, the condition is satisfied and the bar chart is displayed.

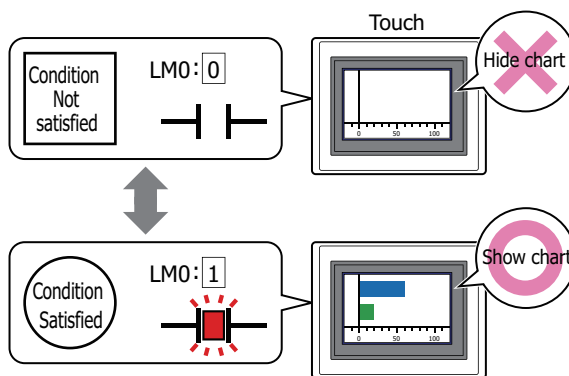

Data over does not operate for hidden bar charts. Data over is reported if the minimum or maximum is exceeded when the bar chart changes from hidden to displayed.

■ **Trigger Type**

Selects the condition to enable the bar chart from the following.

Always Enabled: The bar chart is always enabled.

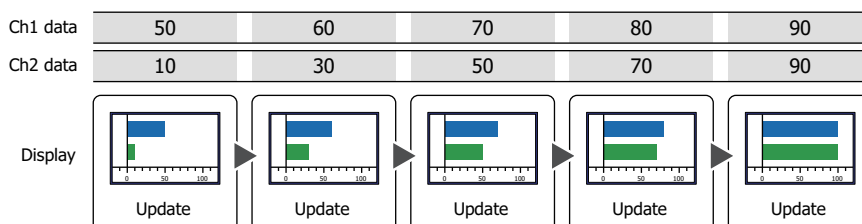

While ON: Enables the bar chart when the value of device is 1.

Example: When **While not satisfying the condition** is **Not update Chart data**

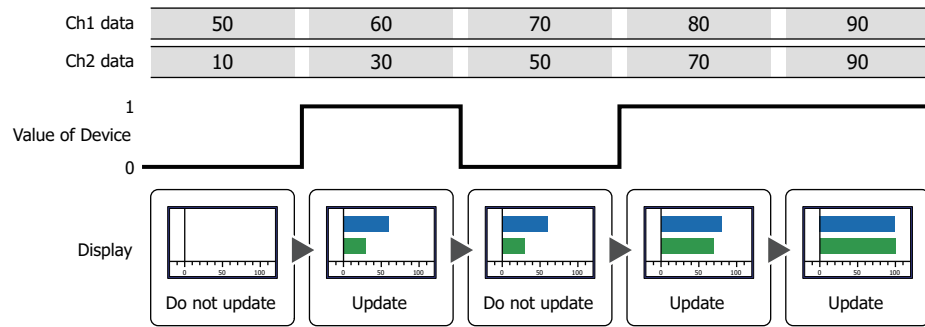

While OFF: Enables the bar chart when the value of device is 0.

Example: When **While not satisfying the condition** is **Not update Chart data**

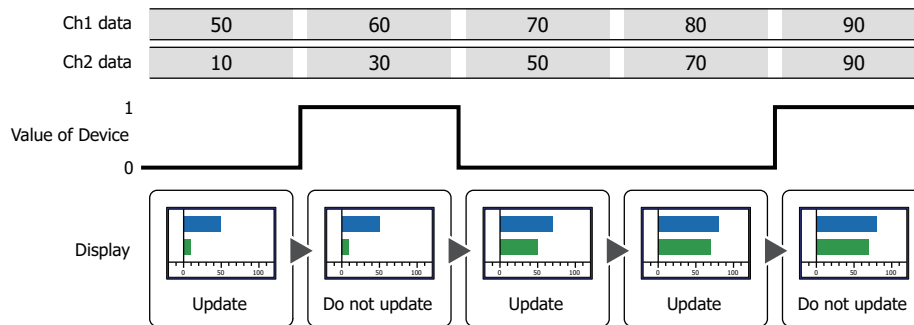

While satisfying the condition:

Enables the bar chart when the condition is satisfied.

Example: When **While not satisfying the condition** is **Not update Chart data**

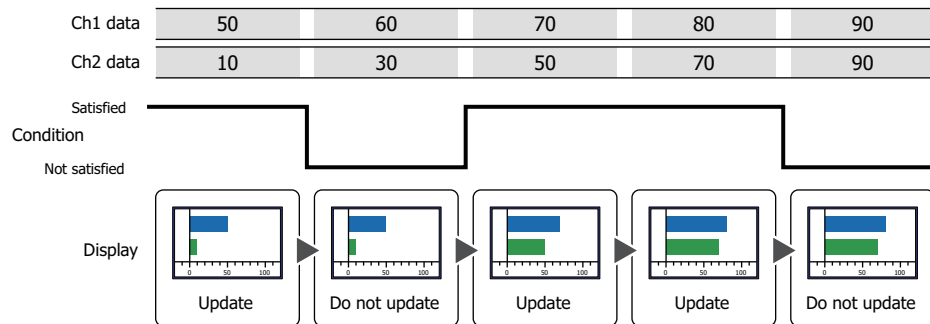

■ **Data Type**

Selects the data type handled by the condition formula.

Can only be set if **While satisfying the condition** is selected as **Trigger Type**.

For details, refer to Chapter 2 “1.1 Available Data” on page 2-1.

■ **Device**

Specifies the bit device or bit of the word device to serve as condition.

Can only be set if **While ON** or **While OFF** is selected as **Trigger Type**.

Click to display the Device Address Settings dialog box. For the device address configuration procedure, refer to Chapter 2 “5.1 Device Address Settings” on page 2-61.

■ **Condition**

Sets the condition formula.

Can only be set if **While satisfying the condition** is selected as **Trigger Type**.

Click to display the Trigger Condition Settings dialog box. For the conditional expression configuration procedure, refer to Chapter 2 “5.2 Setting Conditional Expressions” on page 2-63.

■ While not satisfying the condition

Selects operation of the Bar Chart when condition is not satisfied.

Not display Chart data: The plate and flange are displayed, but Bar Chart is not displayed.

Not update Chart data: The last updated Bar Chart is displayed. The Bar Chart does not change.

■ Comment

Enter a comment about trigger conditions. The maximum number is 80 characters.

● Options Tab

The **Options** tab is displayed in Advanced mode.

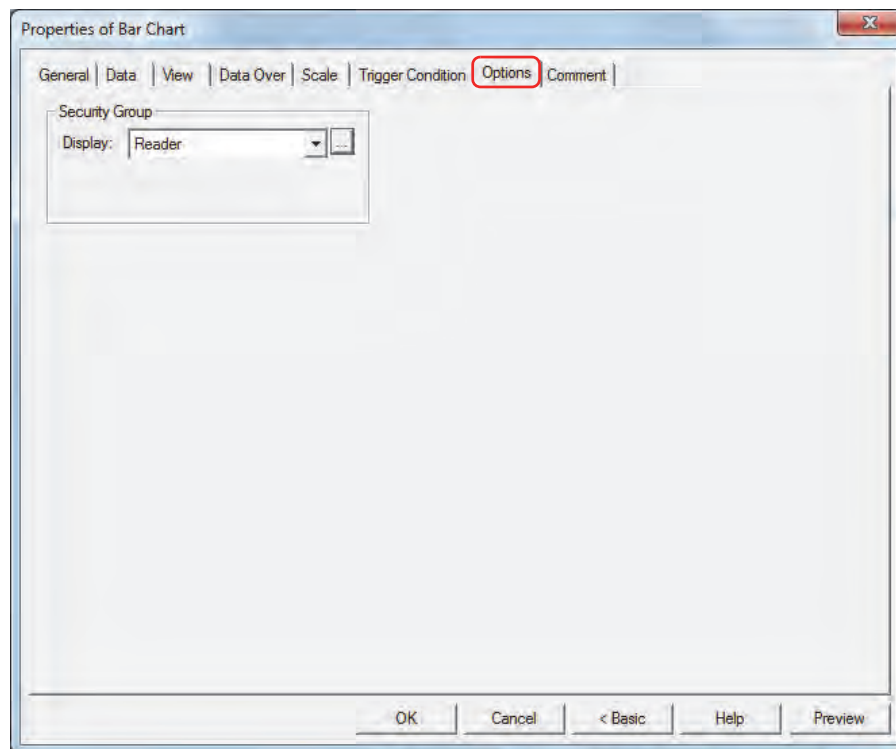

■ Security Group

Security groups are a security function for restricting the display and operation of parts.

Display: Selects the security group for which display of parts is restricted. (Default: None)

None: No security function is used.



Administrator, Operator, Reader: Three security groups are set up by default.

Click  to display the Security Group Settings dialog box. If you create a security group on the Security Group Settings dialog box, you can select that created group. For details, refer to Chapter 21 "2.2 Adding and Editing Security Groups" on page 21-15.



For details about security functions, refer to Chapter 21 "User Accounts and the Security Function" on page 21-1.

Example: If the user and security group for a part are set as follows:

User Name	 User1	 User2
Security Group	None	Group A

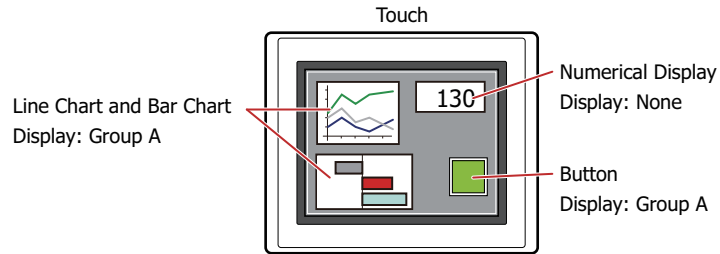

For User1, who is not included in the specified security group, Group A parts are not displayed. If the Password Screen is now opened and User2 logs in, Group A parts are displayed.

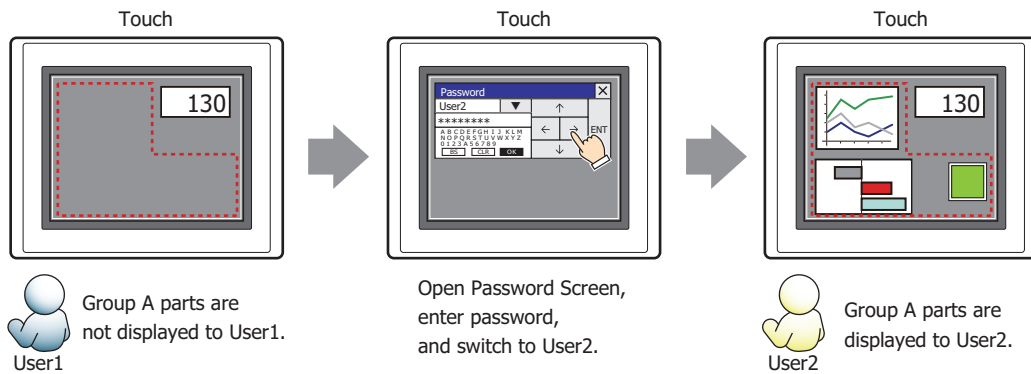

● Comment Tab

The **Comment** tab is used to specify the parts arranged on the editing screen, and the popup text displayed when the mouse pointer is placed close to **No.**, **Name**, or **Type** in the object list.



When there are multiple parts of the same shape on the screen, this feature makes it possible to distinguish between the parts without displaying the Properties dialog box for each part, by just mousing over the part.

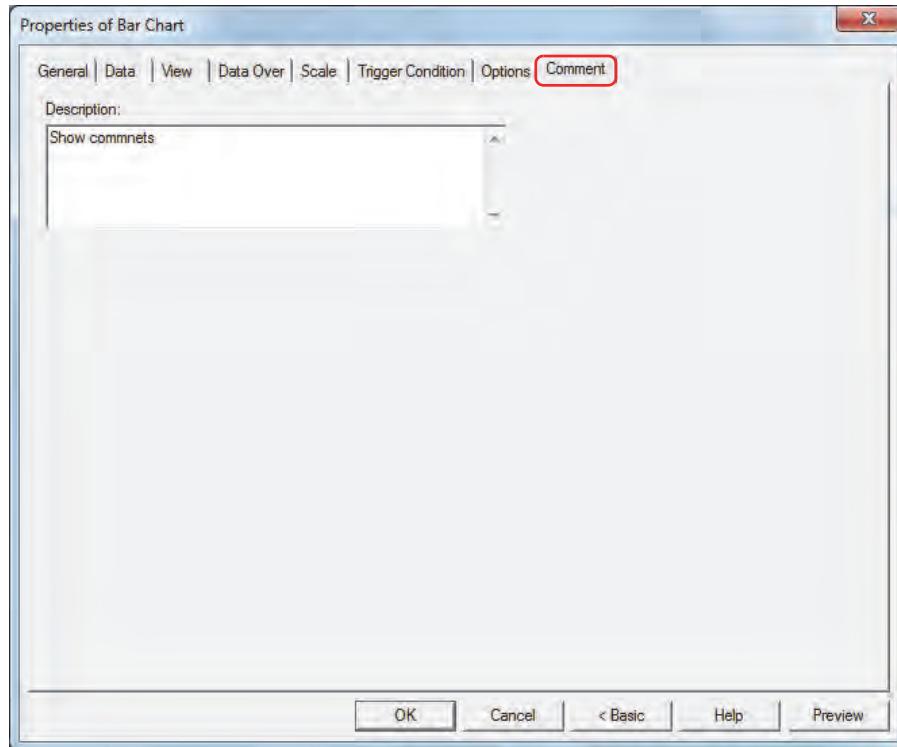

■ Description

Enter a comment about parts. The maximum number is 80 characters.

Example: When mousing over the bar chart on the editing screen

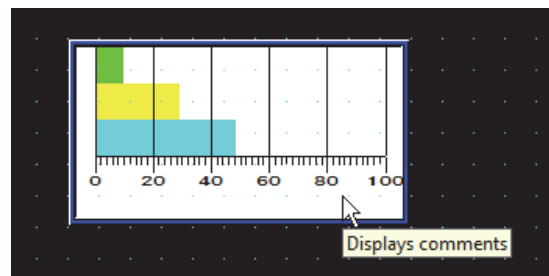

2 Line Chart

2.1 How the Line Chart is Used

The line chart can be used to display values of devices sampled with the Data Log function and the values of multiple word devices.

- Display the values of devices sampled with the Data Log function in a trend chart

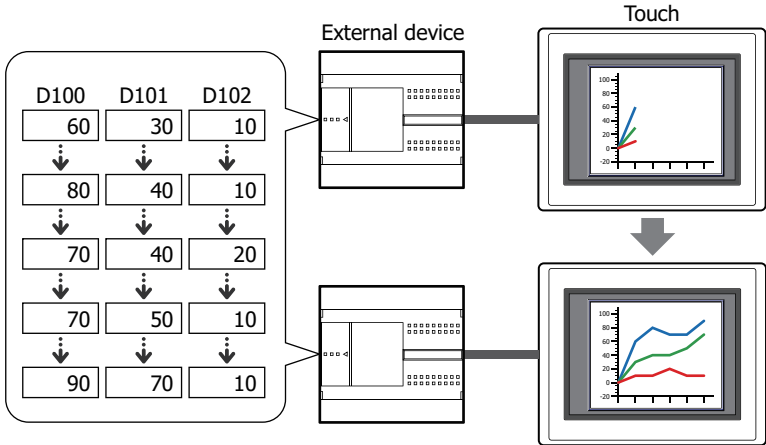

There are two types of trend charts, a normal trend chart and a pen recorder trend chart.

- Display the values of multiple, continuous devices in a single line chart

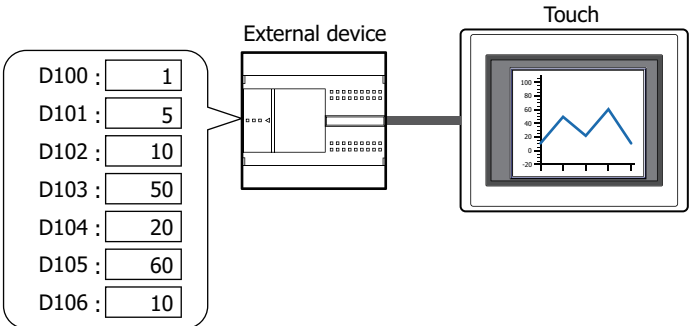

2.2 Line Chart Configuration Procedure

This section describes the configuration procedure for Line Charts.

- 1 On the **Home** tab, in the **Parts** group, click **Charts**, and then click **Line Chart**.

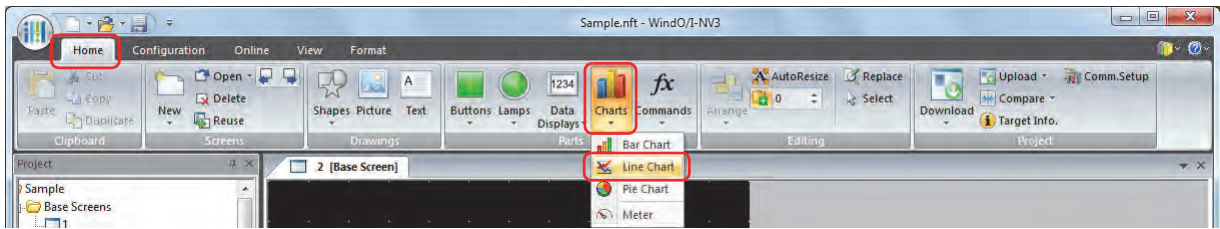

- 2 Click a point on the edit screen where you want to place the Line Chart.
- 3 Double-click the dropped Line Chart and a Properties dialog box will be displayed.
- 4 Change the settings on each tab as necessary.

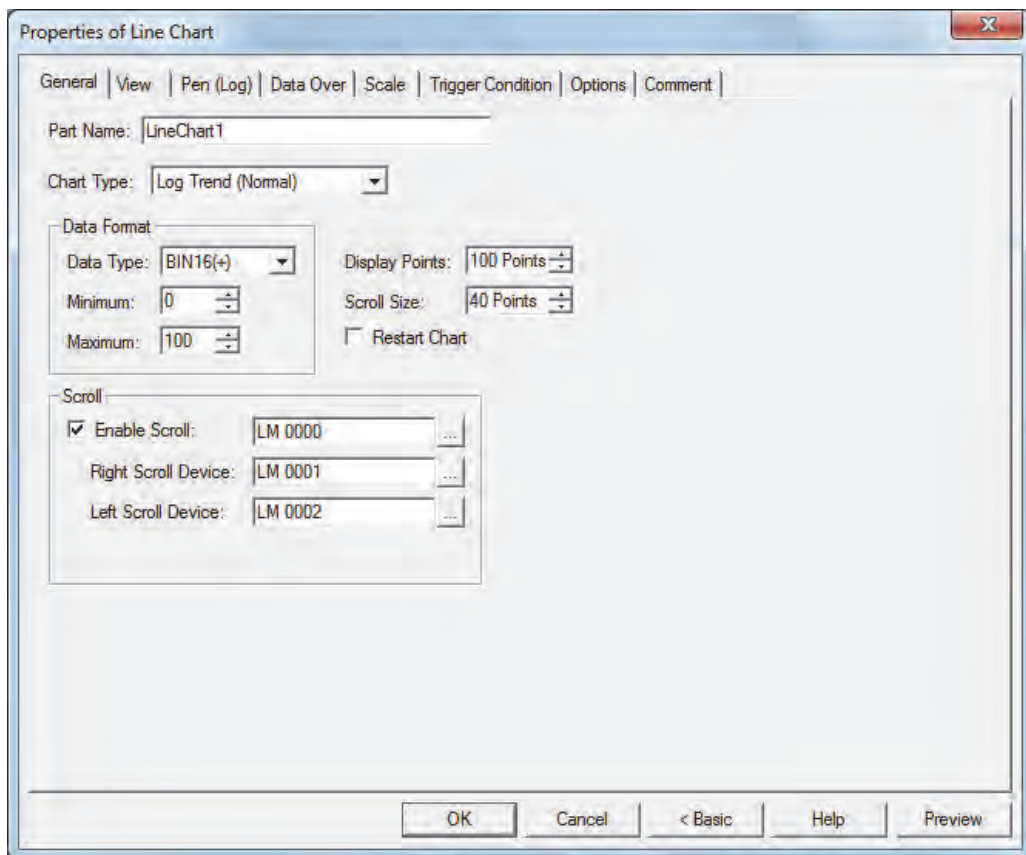

The **Data Over** tab, **Scale** tab, **Trigger Condition** tab and **Options** tab only appear in Advanced mode. To switch to Advanced mode, click **Advanced**.

2.3 Properties of Line Chart Dialog Box

This section describes items and buttons in the Properties dialog box.

● General Tab

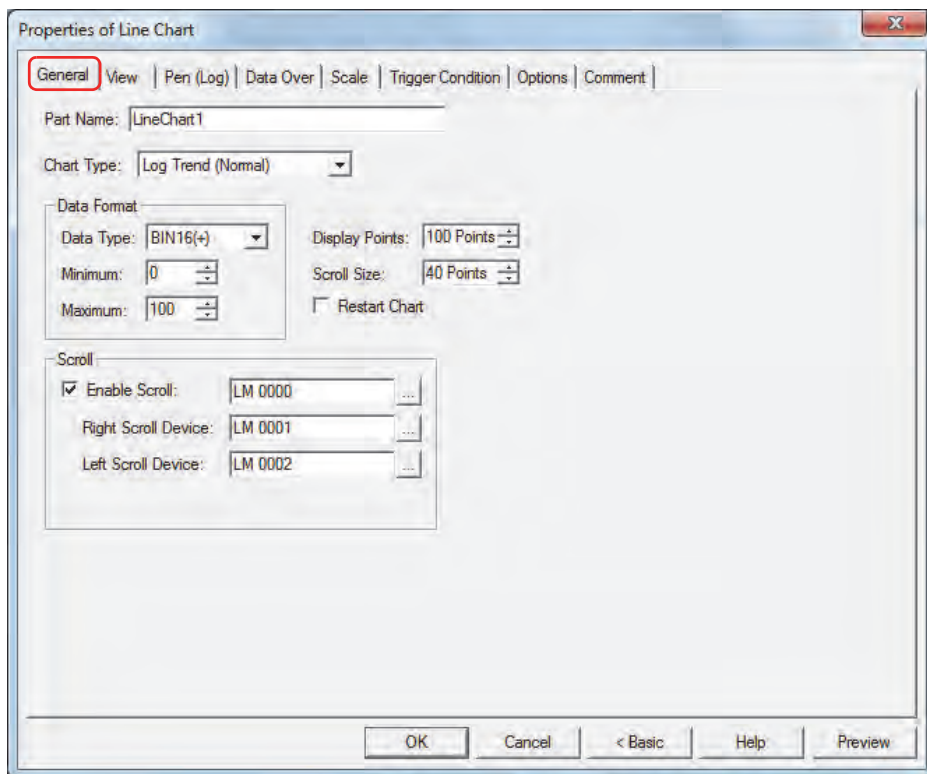

■ Part Name

Enter a name for the part. The maximum number is 20 characters.

■ Chart Type

Selects the type of chart from the following.

Log Trend (Normal):

Shows values of devices sampled with the Data Log function in a trend chart. The displayed chart is updated each time the latest data is sampled and the latest data is charted from the left edge. If the sampled data exceeds the number of display points, the entire chart is shifted to the left by the configured scroll size and the display is updated.

Example: When **Display Points** is 5 and **Scroll Size** is 1

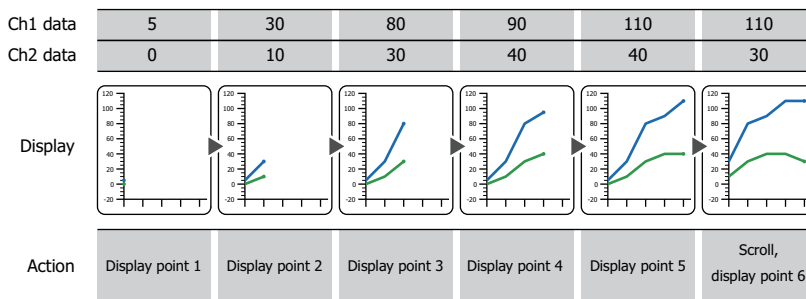

Log Trend (Pen Recorder): Shows values of devices sampled with the Data Log function in a trend chart. The displayed chart is updated each time the latest data is sampled and the latest data is always displayed at the right edge. The entire chart shifts to the left point by point and the display is updated.

Example: When **Display Points** is 5

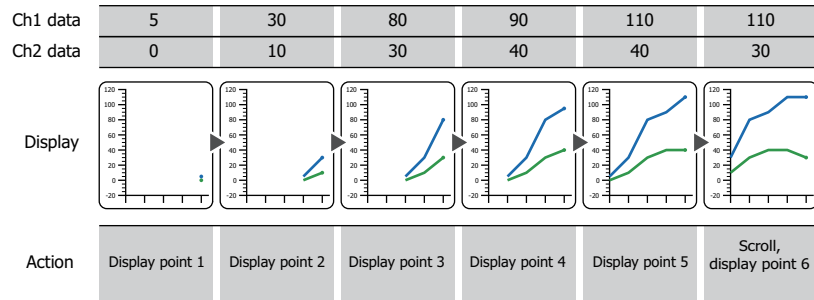

The chart can display a maximum of 20 lines.



To display multiple items of data, set the sampling conditions and data size for the data to display to the same settings. The data cannot be displayed if its sampling conditions or data size is different.

Device Display: Display the values of multiple, continuous devices as a single line chart. The data size for the devices is 16 bits.

Updating and erasing the display is controlled by the lower 2 bits of the starting address value (control status) of the continuous devices.

The number of values of devices to display is specified by the value of starting address + 1.

The values of devices from starting address + 2 are displayed on the chart.

Example: When the starting address is D100

The display updates when the value of D100 changes from 0 to 1. The display is erased when the value changes to 2. The display is first erased and then updated when the value changes to 3.

(Starting address) D100-0 value	Update	0→1	0	0→1	0→1	0→1
D100-1 value	Erase	0	0→1	0	0	0→1
(Starting address +1) D101 value		5	5	3	5	5
Number of devices to display values						
(Starting address +2) D102 value		10	10	70	10	20
(Starting address +3) D103 value		50	50	100	50	80
(Starting address +4) D104 value		20	20	90	20	30
(Starting address +5) D105 value		60	60	110	60	90
(Starting address +6) D106 value		10	10	80	10	20

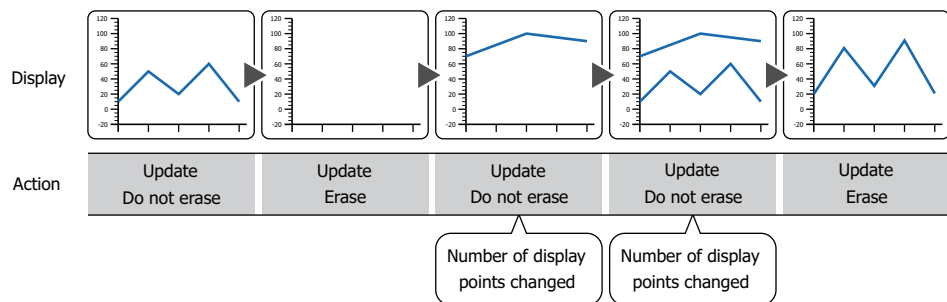

If there are many items of data to display, it may take some time to update the display.

■ **Data Format**

Data Type: Selects the data type handled by the chart from the following.

BIN16(+), BIN16(+/-), BCD4

For details, refer to Chapter 2 "1.1 Available Data" on page 2-1.

Minimum, Maximum: Specifies the minimum and maximum for the chart.

The minimum and maximum vary based on the selected data type. For details, refer to Chapter 2 "1.1 Available Data" on page 2-1.

 If **BCD4** is selected for **Data Type** and the read data contains A through F, 1 is written to System Area 2 Arithmetic error bit (address+2, bit 5), and an error message is displayed. For details, refer to Chapter 3 "Arithmetic error" on page 3-25.

■ **Display Points**

Specifies the maximum number of points of data to display on the chart (2 to (Base Screen horizontal size)).

This option can only be configured when **Log Trend (Normal)** or **Log Trend (Pen Recorder)** is selected for **Chart Type**.

■ **Scroll Size**

Specifies the number of points of data to scroll when updating the chart display (1 to (Base Screen horizontal size)).

This option can only be configured when **Log Trend (Normal)** is selected for **Chart Type**.

Example: When **Display Points** is 5 and **Scroll Size** is 3

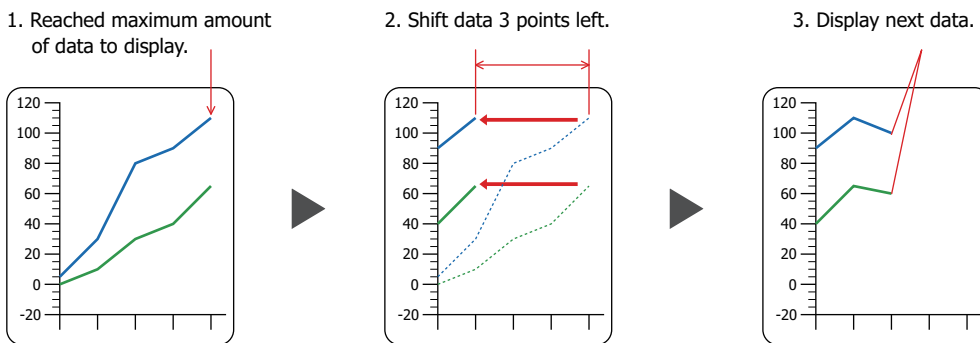

■ **Restart Chart**

Select this check box to display the chart from the beginning when switching screens.

This option can only be configured when **Log Trend (Normal)** or **Log Trend (Pen Recorder)** is selected for **Chart Type**.

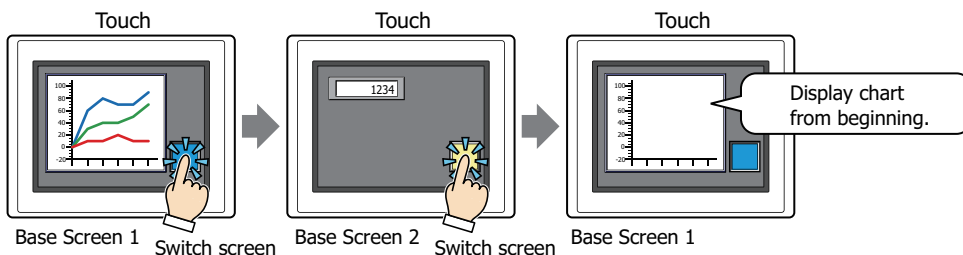

■ Scroll*1

Enable Scroll: To scroll the chart to display past data and to display the cursor, the chart display updating must be stopped. To control updating the display, select this check box and specify the bit device or bit of the word device to control the display.

Click to display the Device Address Settings dialog box. For the device address configuration procedure, refer to Chapter 2 "5.1 Device Address Settings" on page 2-61.

Display updating stops when the value of device changes from 0 to 1. Display updating restarts when the value of device changes from 1 to 0.

This option can only be configured when **Log Trend (Normal)** or **Log Trend (Pen Recorder)** is selected for **Chart Type**.

Right Scroll Device, Left Scroll Device:

The chart can be scrolled to the right or to the left when display updating is stopped. This option specifies the bit device or bit of the word device to scroll the chart left or right.

Click to display the Device Address Settings dialog box. For the device address configuration procedure, refer to Chapter 2 "5.1 Device Address Settings" on page 2-61.

The chart scrolls right or left one point of data each time the value of device changes from 0 to 1. These options can only be configured when the **Control Display Update and Scrolling** check box is selected.

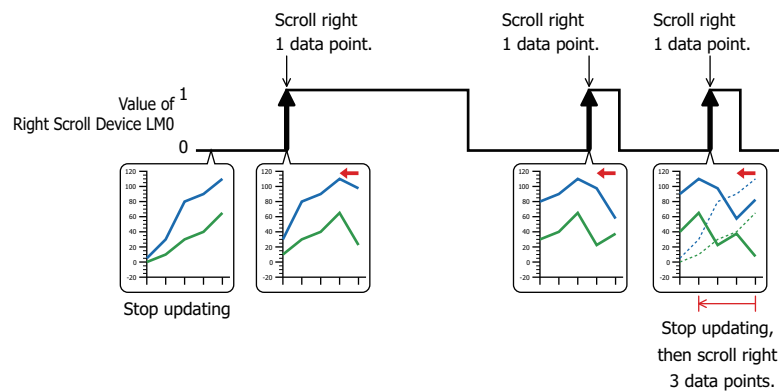

*1 Advanced mode only

● **View Tab**

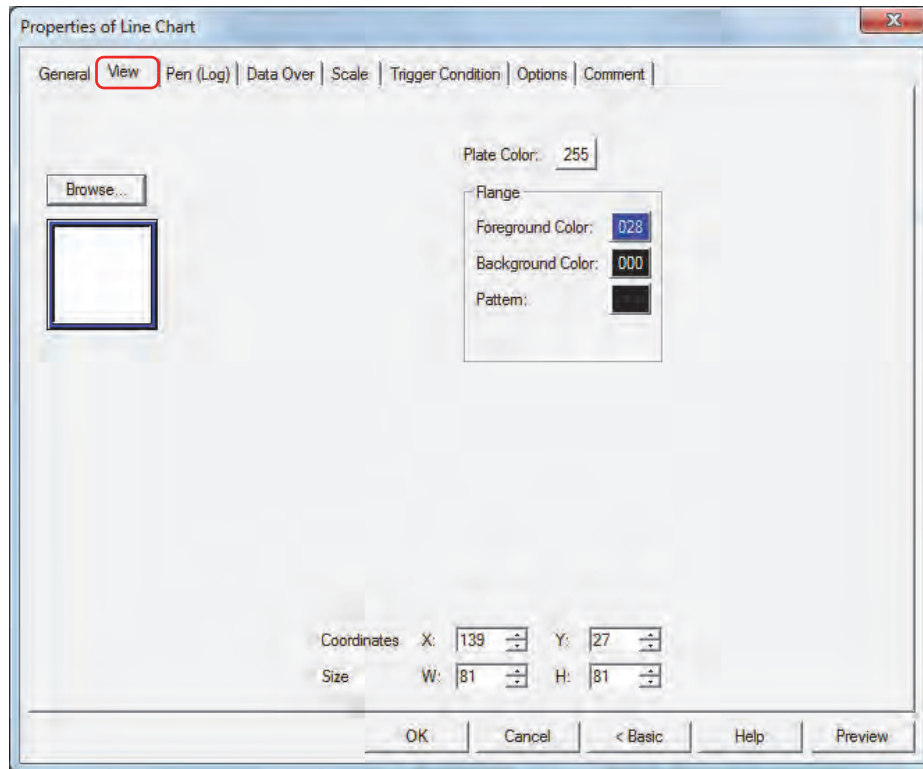

■ **Browse**

Select the type of graphic to be used to represent the part from the list of graphics. Click this button to display the View Browser.

■ **Plate Color**

Selects the plate (color: 256 colors, monochrome: 8 shades).
Click the **Color** button to display the Color Palette. Select a color from the Color Palette.

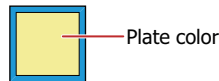

■ **Flange**

Foreground Color, Background Color:

Selects the foreground and background colors of the flange (color: 256 colors, monochrome: 8 shades).

Click the **Color** button to display the Color Palette. Select a color from the Color Palette.

Pattern:

Selects a pattern for the flange.

Click the **Pattern** button to open the Pattern Palette. Select a pattern from the Pattern Palette.

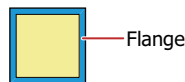

■ **Coordinates**

X, Y:

Sets the display position of parts using coordinates.

The X and Y coordinates of parts are defined relative to an origin at the top-left corner of the screen.

X: 0 to (Base Screen horizontal size - 1)

Y: 0 to (Base Screen vertical size - 1)

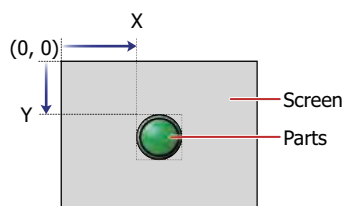

■ **Size**

W, H:

Sets width and height to define the size of parts.

W: 5 to (Base Screen horizontal size)

H: 5 to (Base Screen vertical size)

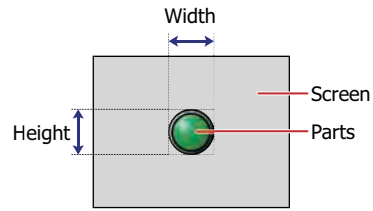

● Pen (Log) Tab

The **Pen (Log)** tab is only displayed when **Log Trend (Normal)** or **Log Trend (Pen Recorder)** is selected for **Chart Type** on the **General** tab.

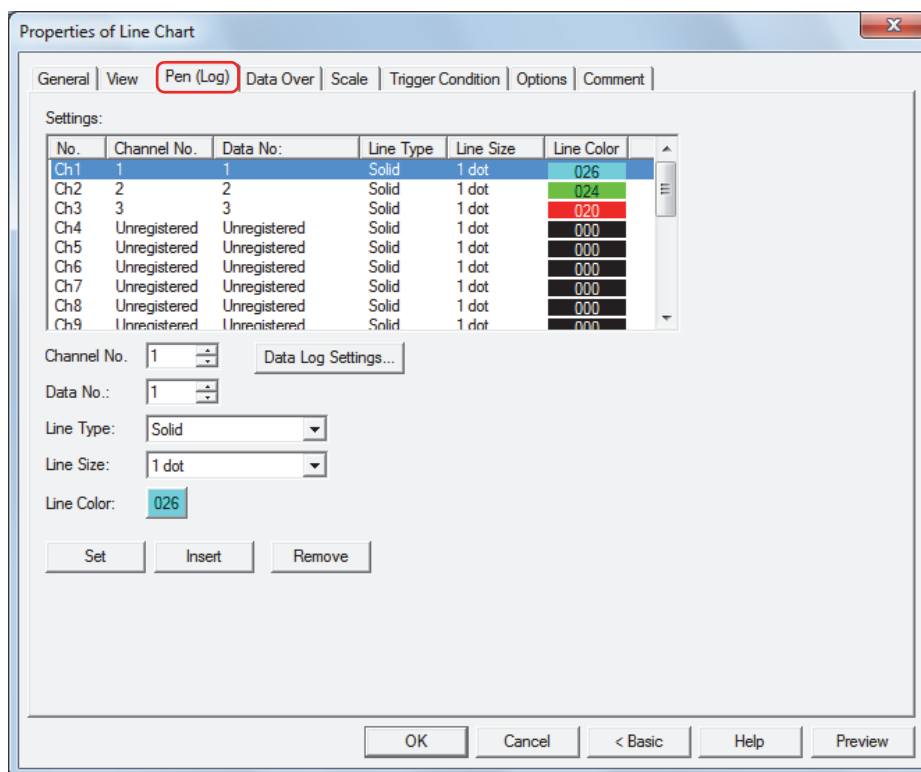

■ Settings

Lists the chart settings.

- No.:
- Channel No.:
- Data No.:
- Line Type:
- Line Size:
- Line Color:

■ Channel No.

Specifies the Data Log channel number to display on the chart (1 to 128).

Data Log Settings: Displays the Data Log Settings dialog box where you can configure the channel while checking the data to display. Select **Channel No.** under **Settings**, and then click **OK** to close the Data Log Settings dialog box. **Channel No.** reflects the selected channel number.

■ Data No.

Specifies the data number to display on the chart out of the data contained in the selected Data Log channel number.

■ Line Type

Selects the type of line from the following.

Solid, Dot, Dash, Long Dash, Long Dash Dot, Long Dash Dot Dot

■ Line Size

Selects the line size from the following.

1 dot, 2 dots, 3 dots, 5 dots

■ **Line Color**

Selects the line color for the chart (color: 256 colors, monochrome: 8 shades).

Click this button to display the Color Palette. Select a color from the Color Palette.

■ **Set**

Registers the chart settings to the list. If you select a Ch number that is already registered, that number is overwritten with the new settings.

Select a Ch number on the list, and then click this button to register the settings for the Data Log **Channel No.** and **Data No.** and the chart **Line Type**, **Line Size**, and **Line Color**.

Always register the settings from Ch1.

■ **Insert**

Inserts the chart settings in the position selected on the list.

Select a Ch number on the list, and then click this button to insert the settings for the Data Log **Channel No.** and **Data No.** and the chart **Line Type**, **Line Size**, and **Line Color**. The settings at the insertion point shift down one line. Settings cannot be inserted if all Ch numbers are configured.

■ **Remove**

Deletes the registered settings from the list.

Select a Ch number, and then click this button to delete the selected settings from the list.

● **Pen (Device) Tab**

The **Pen (Device)** tab is only displayed when **Device Display** is selected for **Chart Type** on the **General** tab.

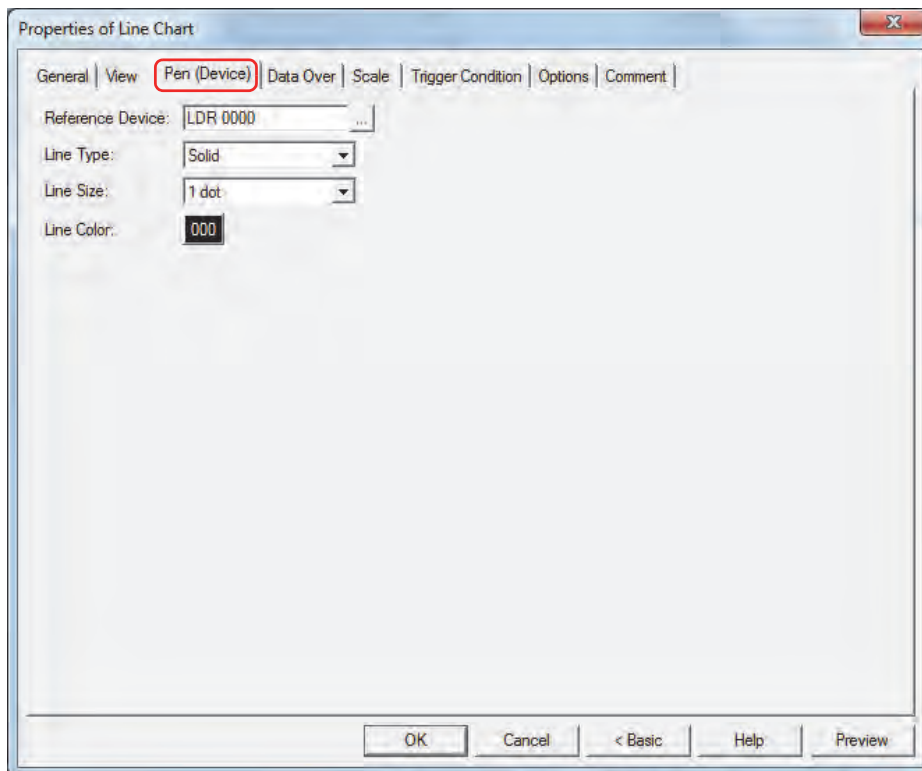

■ **Reference Device**

Specifies the starting address of the data to display on the chart.

Click **...** to display the Device Address Settings dialog box. For the device address configuration procedure, refer to Chapter 2 "5.1 Device Address Settings" on page 2-61.

The data size for the devices is 16 bits.

Updating and erasing the display is controlled by the lower 2 bits of the starting address value (control status).

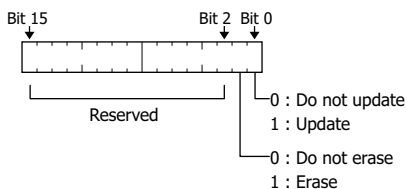

The number of values of devices to display is specified by the value of starting address + 1.

The values of devices from starting address + 2 are displayed on the chart.

Example: If **Reference Device** is set to D100, continuous devices are used starting from D100. The used devices are as follows.

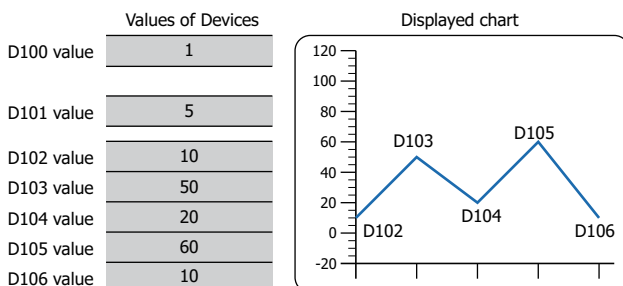
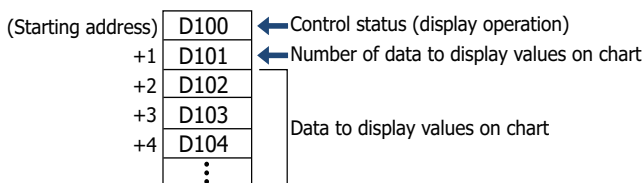

■ **Line Type**

Selects the type of line from the following.

Solid, Dot, Dash, Long Dash, Long Dash Dot, Long Dash Dot Dot

■ **Line Size**

Selects the line size from the following.

1 dot, 2 dots, 3 dots, 5 dots

■ **Line Color**

Selects the line color for the chart (color: 256 colors, monochrome: 8 shades).

Click this button to display the Color Palette. Select a color from the Color Palette.

● **Data Over** Tab

The **Data Over** tab is displayed in Advanced mode.

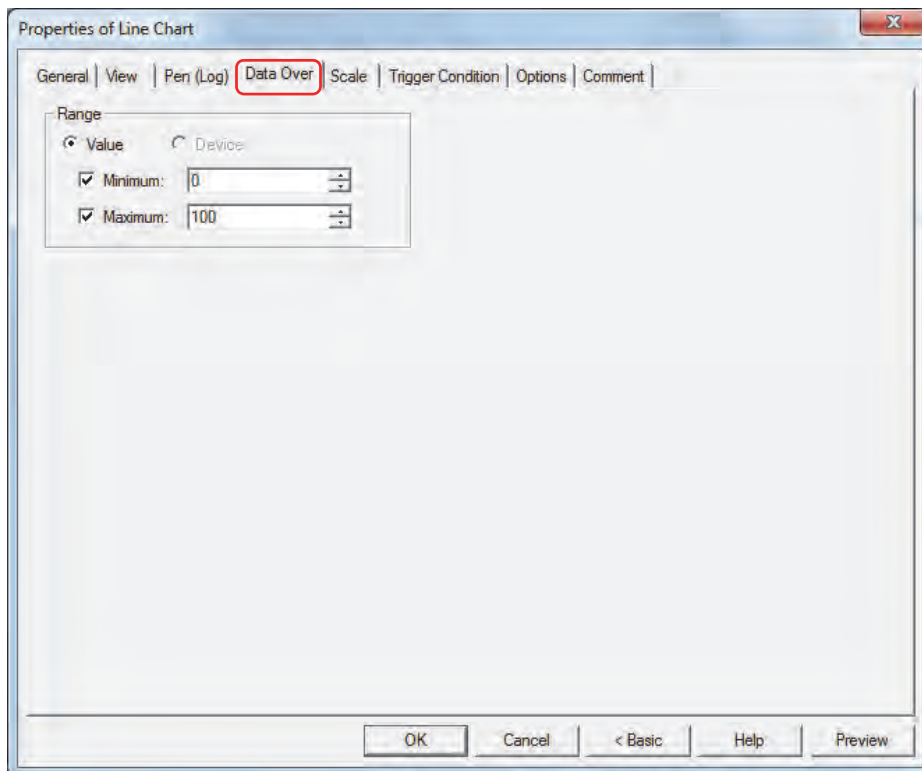

■ **Range**

The type of data is **Value**. This option uses constants for the allowable range. Specifies the allowable range of values to display.

Minimum, Maximum: Select these check boxes to specify the minimum and/or maximum.

The minimum and maximum that can be specified differ according to the data type selected with **Data Format** on the **General** tab. For details on data types, refer to Chapter 2 "1.1 Available Data" on page 2-1.



When grid lines are displayed for the minimum and maximum, select the **Show Gridline** check box on the **Scale** tab and then select **Data Over**.

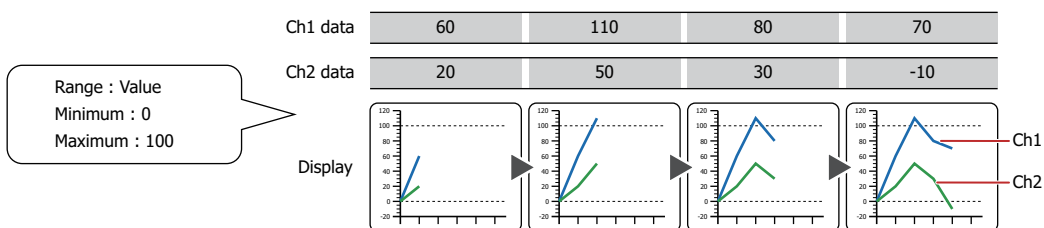

● Scale Tab

The **Scale** tab is displayed in Advanced mode.

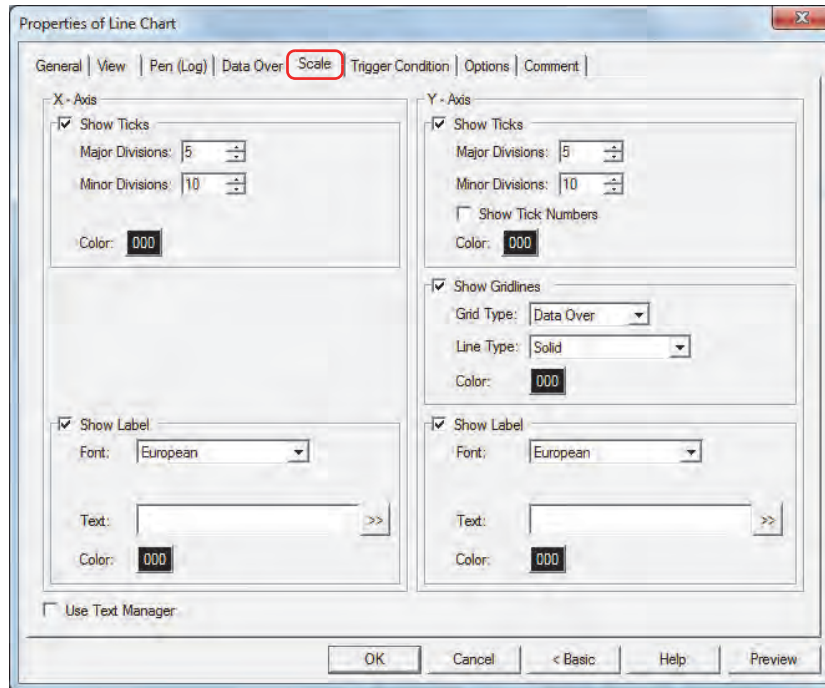

■ Show Ticks

Select this check box to display a scale on a chart.

Major Divisions: Enter the number of major scale divisions (1 to 20).

Minor Divisions: Enter the number of minor scale divisions (1 to 20).

Show Tick Numbers: Select this check box to display numbers along the scale. Can only be set for **Y-Axis**.

Color: Selects the color of scales (color: 256 colors, monochrome: 8 shades).
Click the **Color** button to display the Color Palette. Select a color from the Color Palette.



The numbers and scales will be the same color.



If the area for displaying the scale is small, the scale will not be displayed properly.

■ Show Gridline

Select this check box to display grid lines on the chart. The grid lines are displayed on the chart.

Display Position: Select from **Scale** and **Data Over** to specify the grid line display position.

Scale: Grid lines are displayed according to the number of major scale divisions.
Can only be set when the **Show Ticks** check box is selected.

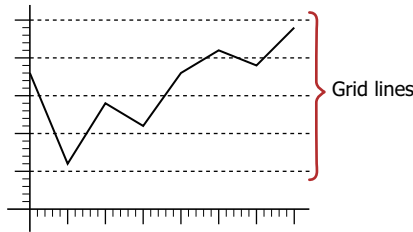

Data Over: Grid lines are displayed at the positions of values specified for **Maximum** and **Minimum** under the **Data Over** tab.

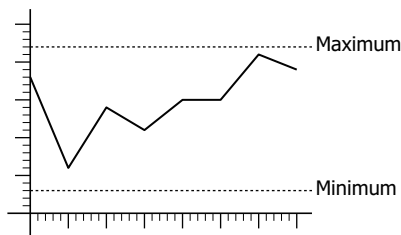

Line Type: Selects the type of grid lines from the following.

Solid, Dot, Dash, Long Dash, Long Dash Dot, Long Dash Dot Dot

Color: Specifies grid line color (color: 256 colors, monochrome: 8 shades).

Click the **Color** button to display the Color Palette. Select a color from the Color Palette.

■ Show Label

Select this check box to display labels on the scale.

Font: Selects the font for text used in labels from the following.

Japanese, European, Chinese, Taiwanese, Korean, Central European, Baltic, Cyrillic

Can only be set when the **Use Text Manager** check box is cleared.

The characters that can be displayed depend on the font. For details, refer to Chapter 2 "1.2 Available Text" on page 2-5.

Text ID: Specifies the Text Manager ID No. (1 to 32,000) when text registered in Text Manager are used for labels.

Click to display Text Manager.

Can only be set when the **Use Text Manager** check box is selected.

Text: Inputs characters to be displayed for labels. The maximum number is 40 characters.

The characters that can be entered depend on the font selected using **Font**. For details, refer to Chapter 2 "1.2 Available Text" on page 2-5.

Can only be input when the **Use Text Manager** check box is cleared.



When entering Unicode characters click to display the Unicode Input dialog box. Enter the characters using the Unicode Input dialog box then click **OK**.

Color: Selects the color of the text used for labels (color: 256 colors, monochrome: 8 shades).

Click the **Color** button to display the Color Palette. Select a color from the Color Palette.

■ Use Text Manager

Select this check box if using the text registered in Text Manager for labels.



If a carriage return (CR) is included, the characters after the CR are not displayed. However, if Windows Font is set for the specified Text ID, all the characters are displayed.

● **Trigger Condition Tab**

The **Trigger Condition** tab is displayed in Advanced mode.

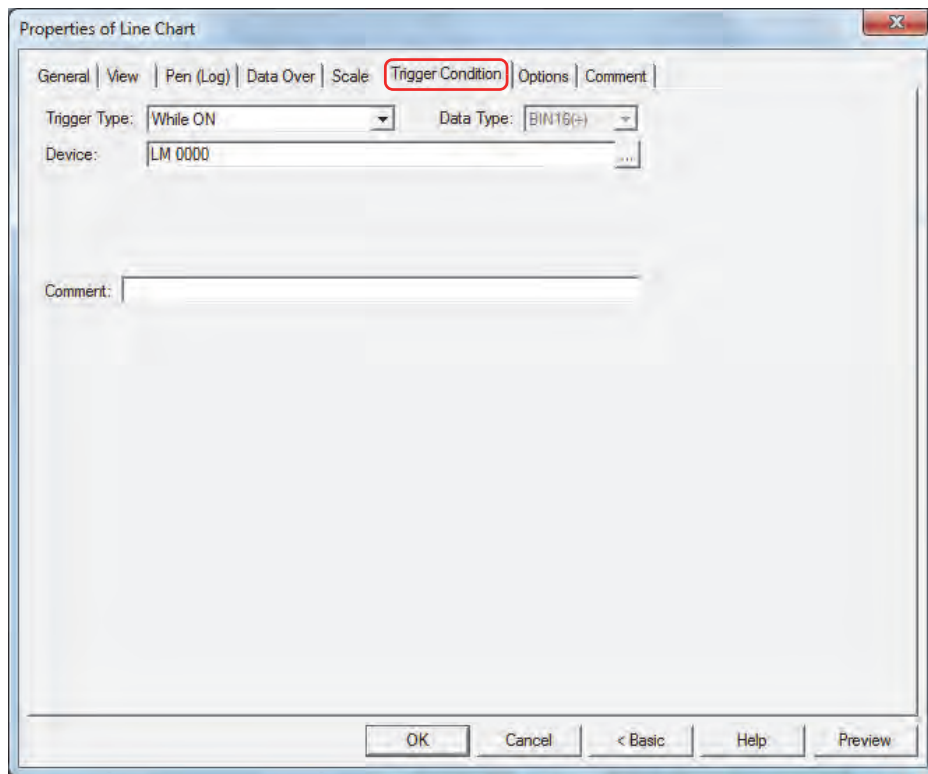

The line chart is enabled while the condition is satisfied, and it is disabled while the condition is not satisfied. When disabled, the plate and flange are displayed, but the chart is not displayed.

Example: When **Trigger Type** is **While ON** and **Device** is LM0

While LM0 is 0, the condition is not satisfied and the line chart is not displayed.

While LM0 is 1, the condition is satisfied and the line chart is displayed.

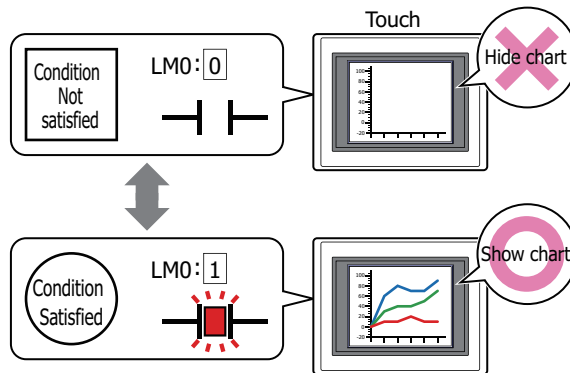

■ **Trigger Type**

Selects the condition to enable the line chart from the following.

Always Enabled: The line chart is always enabled.

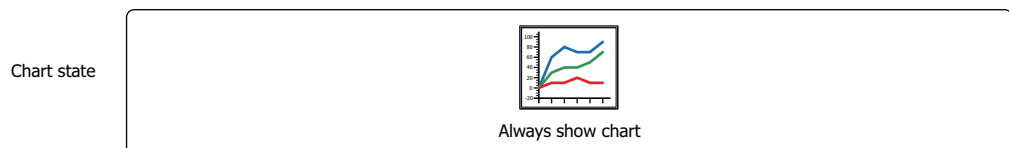

While ON: Enables the line chart when the value of device is 1.

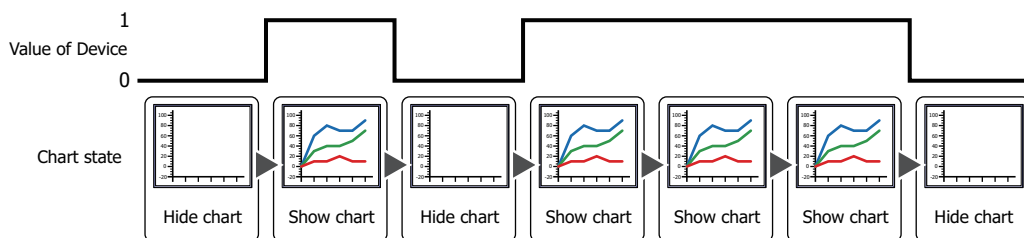

While OFF: Enables the line chart when the value of device is 0.

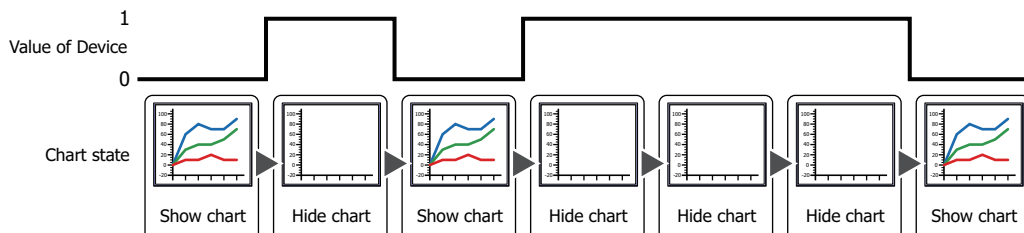

While satisfying the condition:

Enables the line chart when the condition is satisfied.

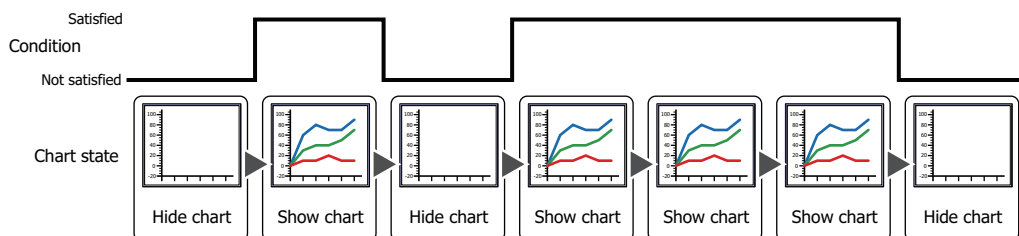

■ Data Type

Selects the data type handled by the condition formula.

Can only be set if **While satisfying the condition** is selected as **Trigger Type**.

For details, refer to Chapter 2 "1.1 Available Data" on page 2-1.

■ Device

Specifies the bit device or bit of the word device to serve as condition.

Can only be set if **While ON** or **While OFF** is selected as **Trigger Type**.

Click to display the Device Address Settings dialog box. For the device address configuration procedure, refer to Chapter 2 "5.1 Device Address Settings" on page 2-61.

■ Condition

Sets the condition formula.

Can only be set if **While satisfying the condition** is selected as **Trigger Type**.

Click to display the Trigger Condition Settings dialog box. For the conditional expression configuration procedure, refer to Chapter 2 "5.2 Setting Conditional Expressions" on page 2-63.

■ Comment

Enter a comment about trigger conditions. The maximum number is 80 characters.

● Options Tab

The **Options** tab is displayed in Advanced mode.

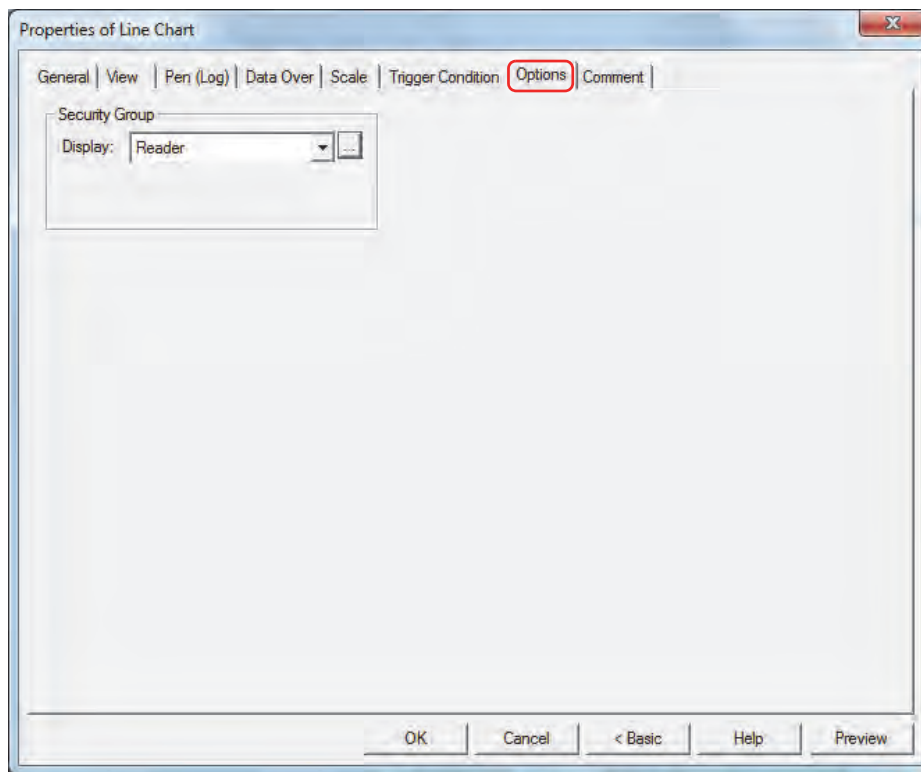

■ Security Group

Security groups are a security function for restricting the display and operation of parts.

Display: Selects the security group for which display of parts is restricted. (Default: None)

None: No security function is used.



Administrator, Operator, Reader: Three security groups are set up by default.

Click  to display the Security Group Settings dialog box. If you create a security group on the Security Group Settings dialog box, you can select that created group. For details, refer to Chapter 21 "2.2 Adding and Editing Security Groups" on page 21-15.



For details about security functions, refer to Chapter 21 "User Accounts and the Security Function" on page 21-1.

Example: If the user and security group for a part are set as follows:

User Name	 User1	 User2
Security Group	None	Group A

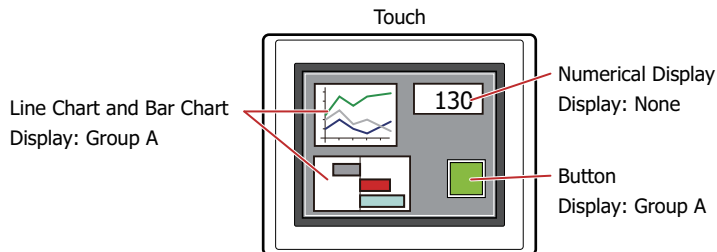

For User1, who is not included in the specified security group, Group A parts are not displayed. If the Password Screen is now opened and User2 logs in, Group A parts are displayed.

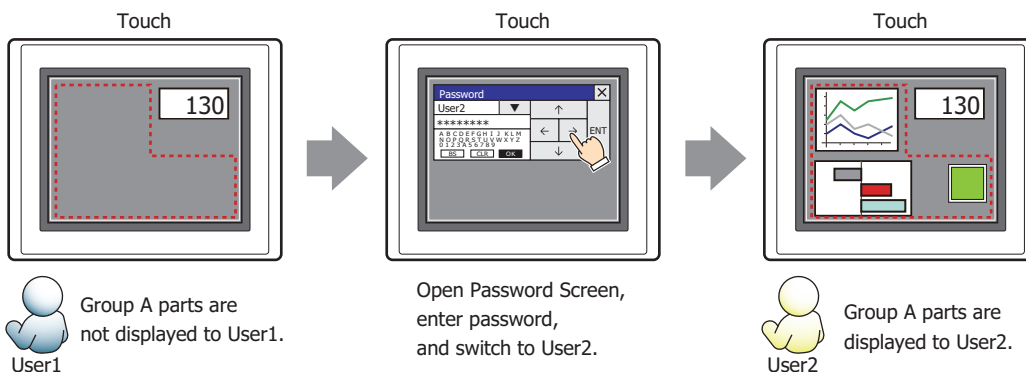

● Comment Tab

The **Comment** tab is used to specify the parts arranged on the editing screen, and the popup text displayed when the mouse pointer is placed close to **No.**, **Name**, or **Type** in the object list.



When there are multiple parts of the same shape on the screen, this features makes it possible to distinguish between the parts without displaying the Properties dialog box for each part, by just mousing over the part.

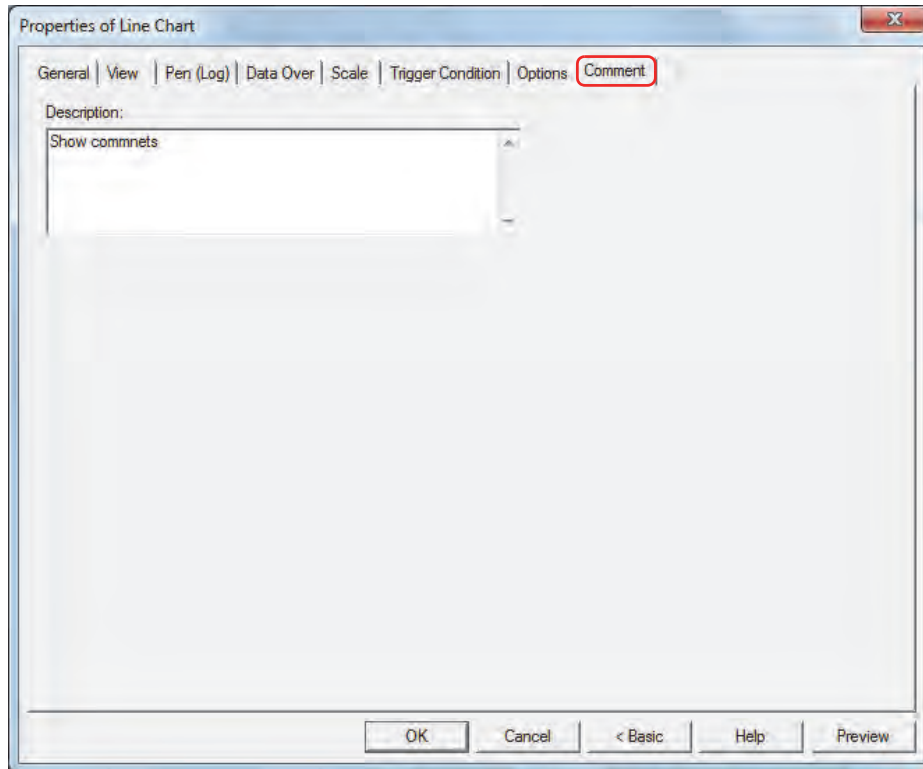

■ Description

Enter a comment about parts. The maximum number is 80 characters.

Example: When mousing over the line chart on the editing screen

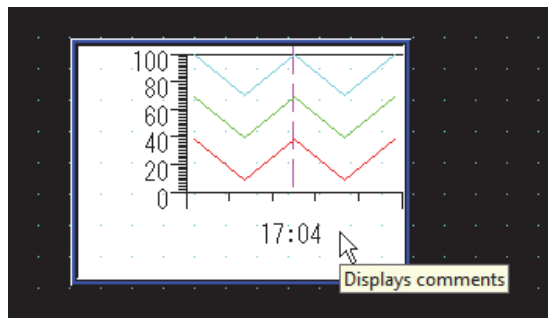

3 Pie Chart

3.1 How the Pie Chart is Used

The stacked bar chart and pie chart are used to show the proportion of individual data to the sum of the data. They can be used to check the relative change in the values of multiple devices in real-time.

- Display the proportion for the sum of values of multiple devices in a stacked bar chart or a pie chart

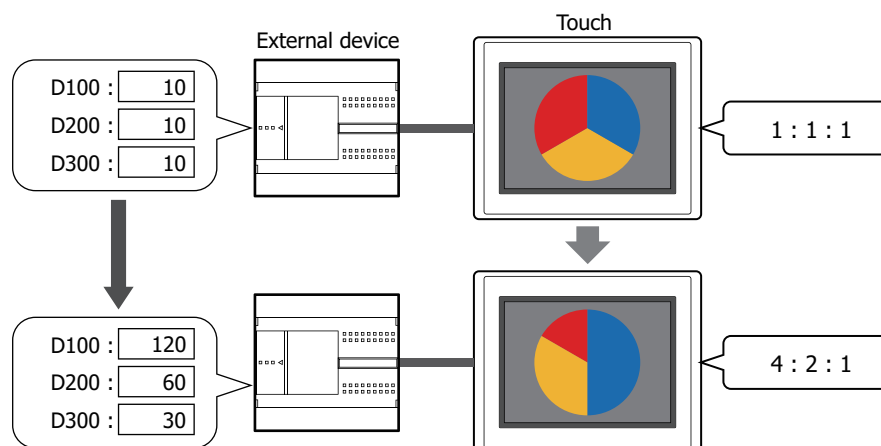

If the source data is all 0, the chart shows the same proportion for all the data.

3.2 Pie Chart Configuration Procedure

This section describes the configuration procedure for pie charts.

- 1 On the **Home** tab, in the **Parts** group, click **Charts**, and then click **Pie Chart**.

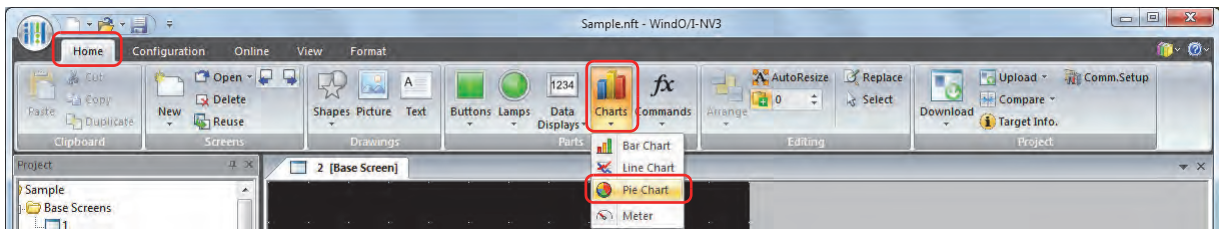

- 2 Click a point on the edit screen where you want to place the Pie Chart.
- 3 Double-click the dropped Pie Chart and a Properties dialog box will be displayed.
- 4 Change the settings on each tab as necessary.

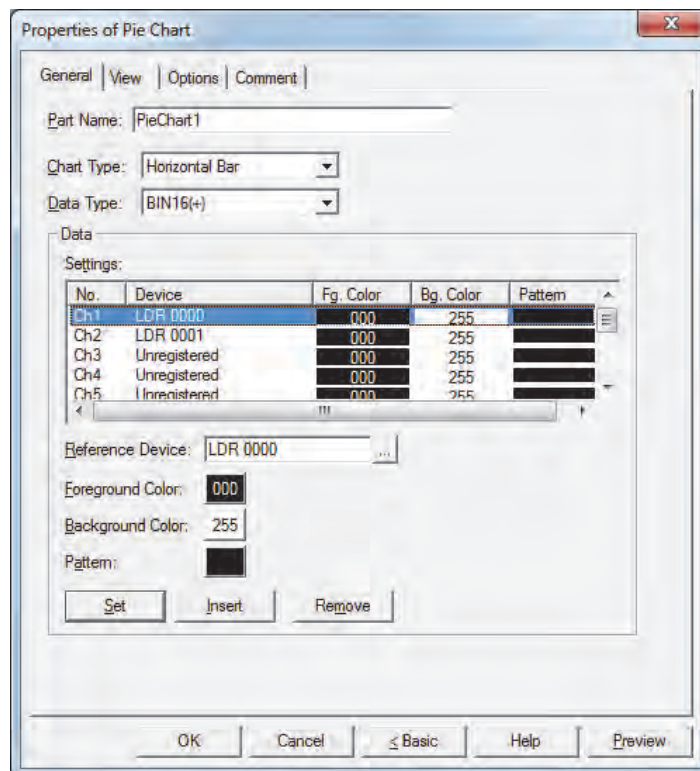

The **Options** tab only appears in Advanced mode.

To switch to Advanced mode, click **Advanced**.

3.3 Properties of Pie Chart Dialog Box

This section describes items and buttons in the Properties dialog box.

● **General Tab**

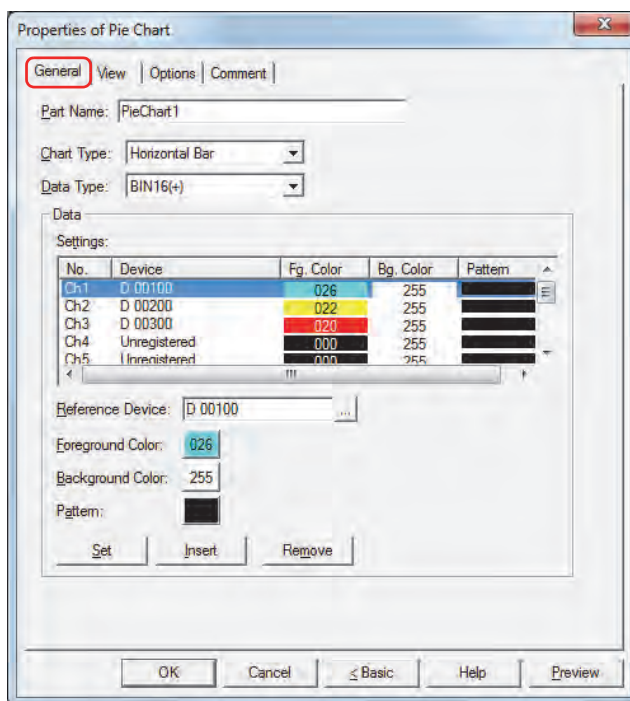

■ **Part Name**

Enter a name for the part. The maximum number is 20 characters.

■ **Chart Type**

Select the type of chart from the following items.

Horizontal Bar: Shows the proportion of the sum of the data as a horizontal stacked bar chart.

Example: When displaying the values for three devices

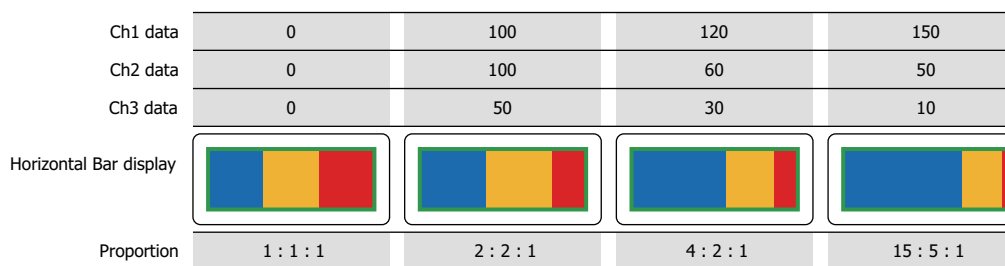

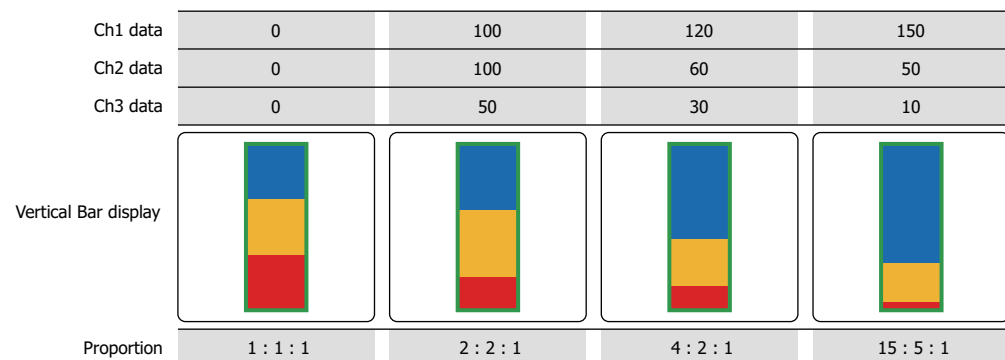

Vertical Bar: Shows the proportion of the sum of the data as a vertical stacked bar chart.

Example: When displaying the values for three devices

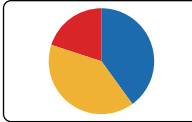

Pie: Shows the proportion of the sum of the data as a pie chart.

Example: When displaying the values for three devices

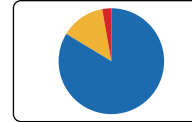
Ch1 data	0	100	120	300
Ch2 data	0	100	60	50
Ch3 data	0	50	30	10
Pie chart display				
Proportion	1 : 1 : 1	2 : 2 : 1	4 : 2 : 1	30 : 5 : 1

Data Type

Selects the data type handled by the chart.

For details, refer to Chapter 2 "1.1 Available Data" on page 2-1.



If **BCD4** or **BCD8** is selected and the read data contains A through F, 1 is written to System Area 2 Arithmetic error bit (address+2, bit 5), and an error message is displayed. For details, refer to Chapter 3 "Arithmetic error" on page 3-25.

Settings

Lists the chart settings. The list shows the numbers, source devices, and colors for the chart.

No.: Shows the numbers for the chart (Ch1 to Ch10).

For **Horizontal Bar**, the numbers are listed in order from the left. For **Vertical Bar**, the numbers are listed in order from the top.

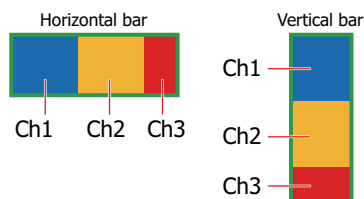

For **Pie**, the numbers are listed clockwise.



Device: Shows the source device.

Fg. Color: Shows the foreground color of the chart.

Bg. Color: Shows the background color of the chart.

Pattern: Shows the chart pattern.

Reference Device

Specifies the source word device for the data to display in the chart.

Click to display the Device Address Settings dialog box. For the device address configuration procedure, refer to Chapter 2 "5.1 Device Address Settings" on page 2-61.

Foreground Color

Selects the foreground color for the chart (color: 256 colors, monochrome: 8 shades).

Click this button to display the Color Palette. Select a color from the Color Palette.

Background Color

Selects the background color for the chart (color: 256 colors, monochrome: 8 shades).

Click this button to display the Color Palette. Select a color from the Color Palette.

■ Pattern

Selects the chart pattern.

Click this button to display the Pattern Palette. Select a pattern from the Pattern Palette.

■ Set

Registers the chart settings to the list. If you select a Ch number that is already registered, that number is overwritten with the new settings.

Select a Ch number on the list, and then click this button to register the **Reference Device**, **Foreground Color**, **Background Color**, and **Pattern** settings.

■ Insert

Inserts the chart settings in the position selected on the list.

Select a Ch number on the list, and then click this button to insert the **Reference Device**, **Foreground Color**, **Background Color**, and **Pattern** settings. The settings at the insertion point shift down one line. Settings cannot be inserted if all Ch numbers are configured.

■ Remove

Deletes the registered settings from the list.

Select a Ch number, and then click this button to delete the selected settings from the list.

● **View Tab**

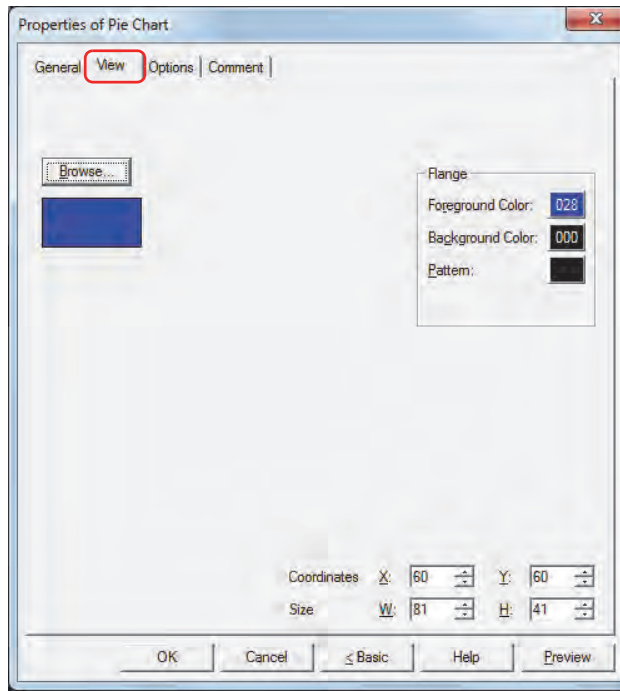

■ **Browse**

Select the type of graphic to be used to represent the part from the list of graphics. Click this button to display the View Browser.

■ **Flange**

Foreground Color, Background Color:

Selects the foreground and background colors of the flange (color: 256 colors, monochrome: 8 shades).

Click the **Color** button to display the Color Palette. Select a color from the Color Palette.

Pattern:

Selects a pattern for the flange.

Click the **Pattern** button to open the Pattern Palette. Select a pattern from the Pattern Palette.

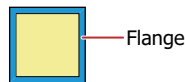

■ **Coordinates**

X, Y:

Sets the display position of parts using coordinates.

The X and Y coordinates of parts are defined relative to an origin at the top-left corner of the screen.

X: 0 to (Base Screen horizontal size - 1)

Y: 0 to (Base Screen vertical size - 1)

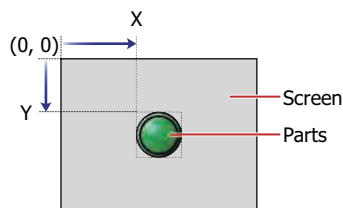

■ **Size**

W, H:

Sets width and height to define the size of parts.

W: 5 to (Base Screen horizontal size)

H: 5 to (Base Screen vertical size)

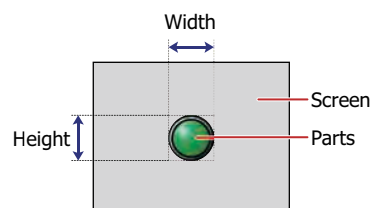

● Options Tab

The **Options** tab is displayed in Advanced mode.

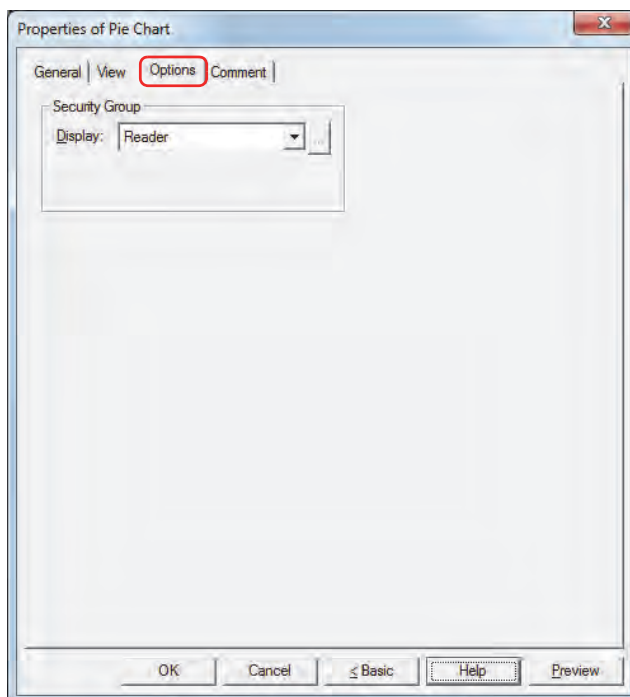

■ Security Group

Security groups are a security function for restricting the display and operation of parts.

Display: Selects the security group for which display of parts is restricted. (Default: None)

None: No security function is used.



Administrator, Operator, Reader: Three security groups are set up by default.

Click  to display the Security Group Settings dialog box. If you create a security group on the Security Group Settings dialog box, you can select that created group. For details, refer to Chapter 21 “2.2 Adding and Editing Security Groups” on page 21-15.



For details about security functions, refer to Chapter 21 “User Accounts and the Security Function” on page 21-1.

Example: If the user and security group for a part are set as follows:

User Name	 User1	 User2
Security Group	None	Group A

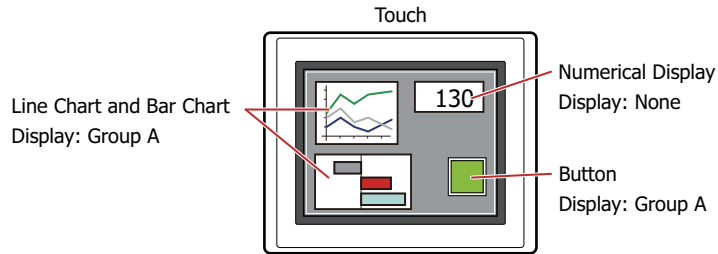

For User1, who is not included in the specified security group, Group A parts are not displayed.
If the Password Screen is now opened and User2 logs in, Group A parts are displayed.

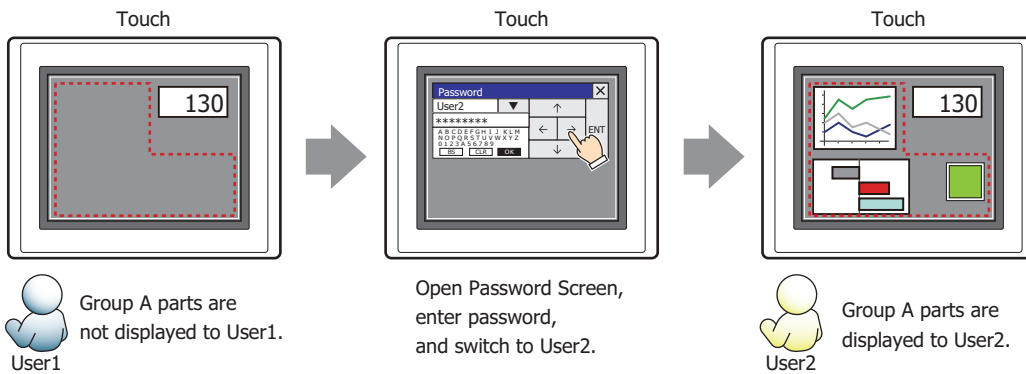

● Comment Tab

The **Comment** tab is used to specify the parts arranged on the editing screen, and the popup text displayed when the mouse pointer is placed close to **No.**, **Name**, or **Type** in the object list.



When there are multiple parts of the same shape on the screen, this features makes it possible to distinguish between the parts without displaying the Properties dialog box for each part, by just mousing over the part.

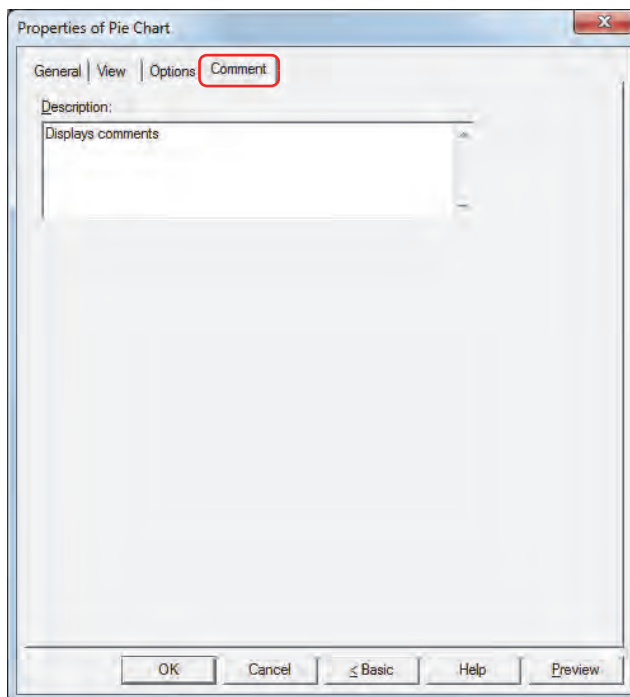

■ Description

Enter a comment about parts. The maximum number is 80 characters.

Example: When mousing over the pie chart on the editing screen

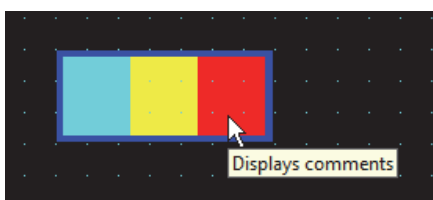

4 Meter

4.1 How the Meter is Used

The meter displays the value of a word device as the movement of a needle.

- Display the value of a word device in a meter

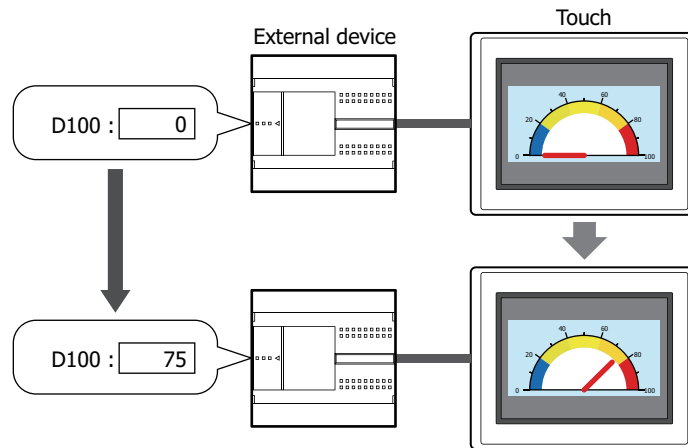

4.2 Meter Configuration Procedure

This section describes the configuration procedure for meters.

- 1 On the **Home** tab, in the **Parts** group, click **Charts**, and then click **Meter**.

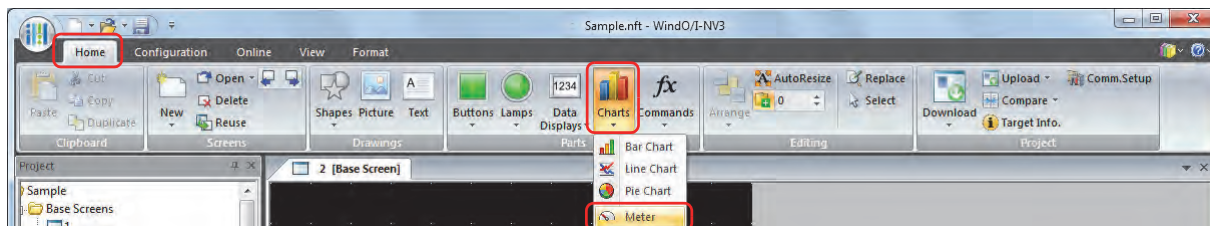

- 2 Click a point on the edit screen where you want to place the Meter.
- 3 Double-click the dropped Meter and a Properties dialog box will be displayed.
- 4 Change the settings on each tab as necessary.

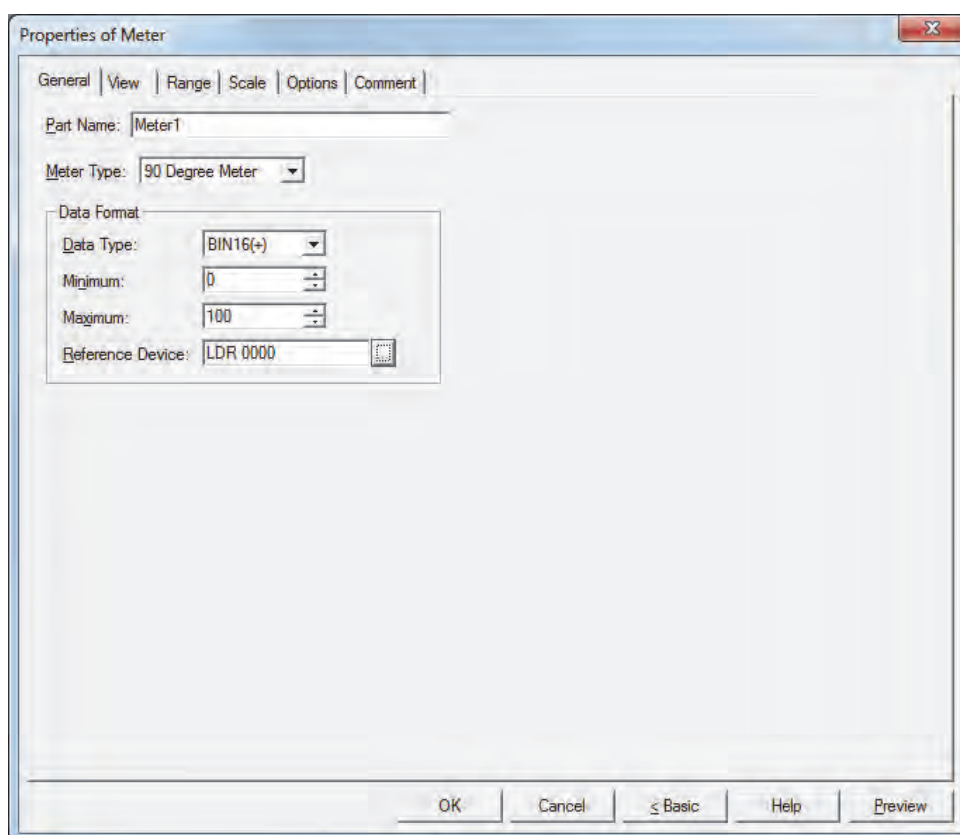

The **Range** tab, **Scale** tab and **Options** tab only appear in Advanced mode.
To switch to Advanced mode, click **Advanced**.

4.3 Properties of Meter Dialog Box

This section describes items and buttons in the Properties dialog box.

● General Tab

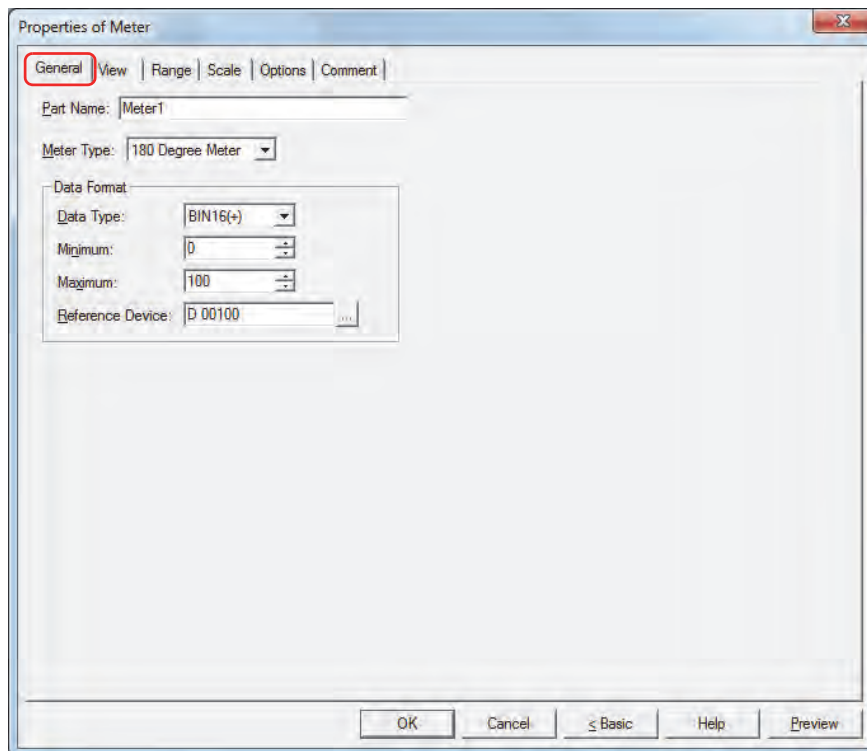

■ Part Name

Enter a name for the part. The maximum number is 20 characters.

■ Meter Type

Select the type of meter from the following items.

90 Degree Meter, 180 Degree Meter, 270 Degree Meter

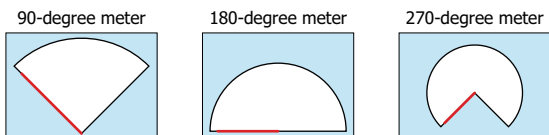

Example: **180 Degree Meter**

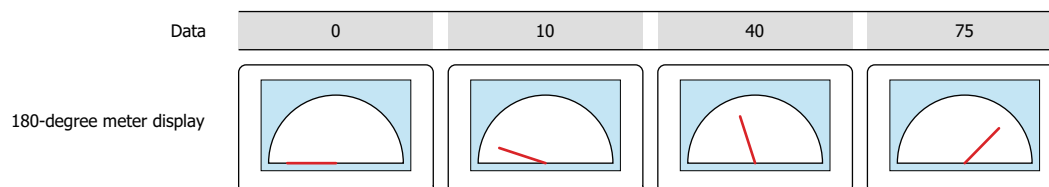

■ Data Format

- Data Type: Selects the data type handled by the meter.
For details, refer to Chapter 2 “1.1 Available Data” on page 2-1.
- Minimum, Maximum: Specifies the minimum and maximum for the data.
The minimum and maximum vary based on the selected data type. For details, refer to Chapter 2 “1.1 Available Data” on page 2-1.
The needle does not move past the left edge when the data value is the minimum or lower.
The needle stops at the right edge when the data value is the maximum or higher.



If **BCD4** is selected for **Data Type** and the read data contains A through F, 1 is written to System Area 2 Arithmetic error bit (address+2, bit 5), and an error message is displayed. For details, refer to Chapter 3 “Arithmetic error” on page 3-25.

■ Reference Device

- Specifies the source word device for the data to display in the meter.
- Click  to display the Device Address Settings dialog box. For the device address configuration procedure, refer to Chapter 2 “5.1 Device Address Settings” on page 2-61.

● View Tab

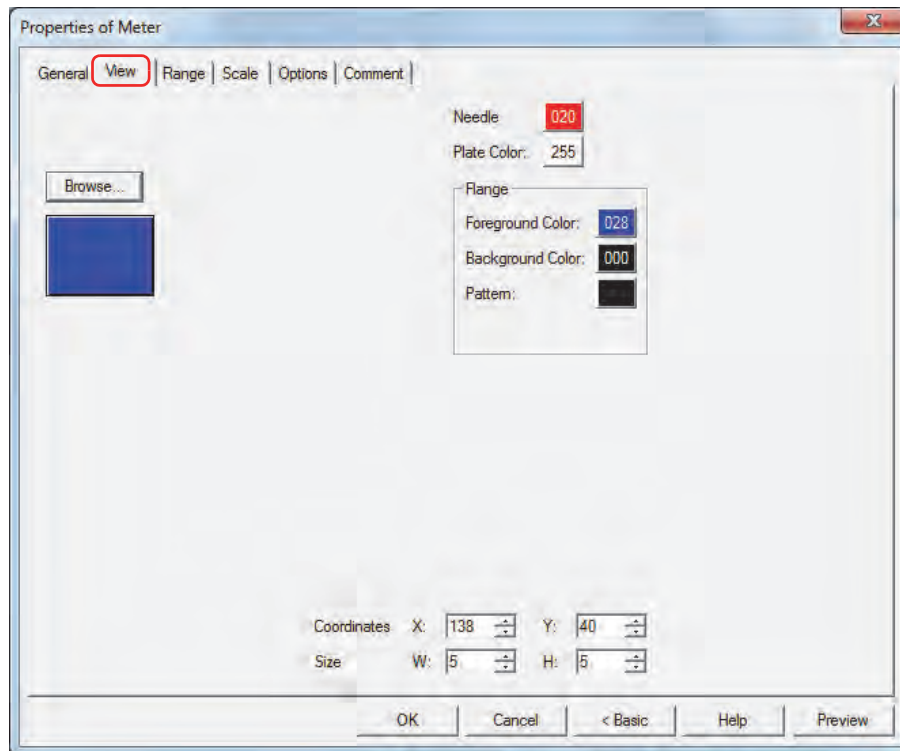

■ Browse

Select the type of graphic to be used to represent the part from the list of graphics. Click this button to display the View Browser.

■ Needle

Selects the needle color of the Meter (color: 256 colors, monochrome: 8 shades).

Click the **Color** button to display the Color Palette. Select a color from the Color Palette.



■ Plate Color

Selects the plate color of the standard graphic (color: 256 colors, monochrome: 8 shades).

Click the **Color** button to display the Color Palette. Select a color from the Color Palette.

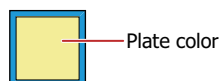

■ Flange

Foreground Color, Background Color:

Selects the foreground and background colors of the flange of the standard graphic (color: 256 colors, monochrome: 8 shades).

Click the **Color** button to display the Color Palette. Select a color from the Color Palette.

Pattern:

Selects a pattern for the flange of the standard graphic.

Click the **Pattern** button to display the Pattern Palette. Select a pattern from the Pattern Palette.

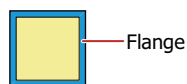

■ Coordinates

X, Y: Sets the display position of parts using coordinates.

The X and Y coordinates of parts are defined relative to an origin at the top-left corner of the screen.

X: 0 to (Base Screen horizontal size - 1)

Y: 0 to (Base Screen vertical size - 1)

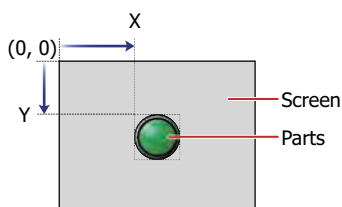

■ Size

W, H: Sets width and height to define the size of parts.

W: 5 to (Base Screen horizontal size)

H: 5 to (Base Screen vertical size)

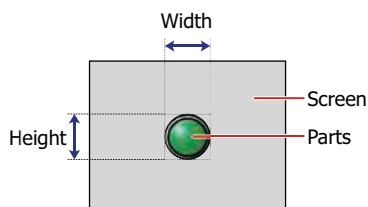

● Range Tab

The **Range** tab is only displayed in Advanced mode.

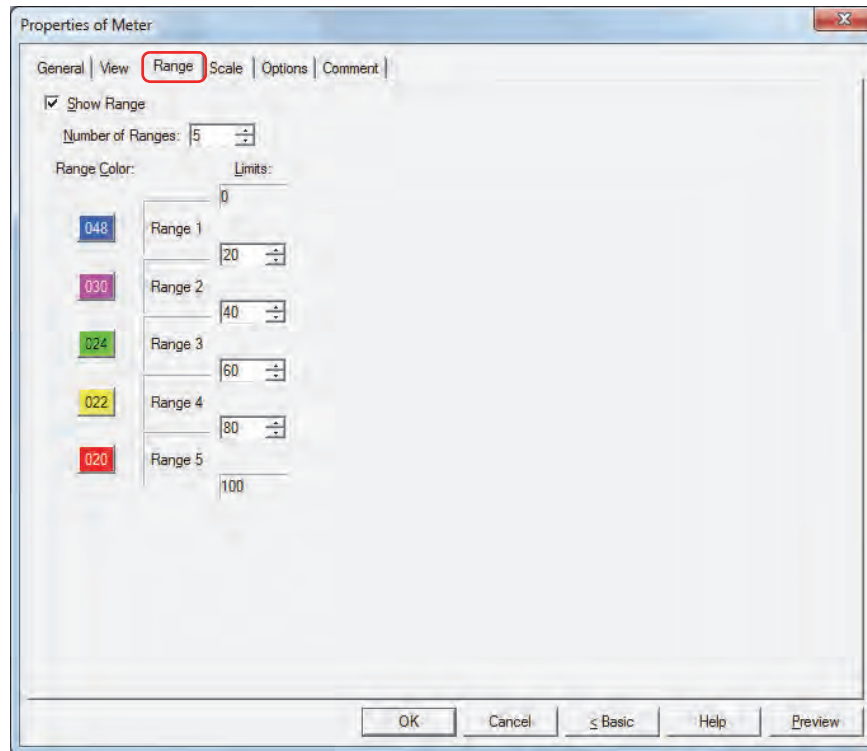

■ Show Range

Select this check box to show ranges on the meter and configure the number of ranges, range colors, and limits.

Number of Ranges: Specifies the number of ranges (1 to 5).

Range Color: Selects the range color (color: 256 colors, monochrome: 8 shades).
Click this button to display the Color Palette. Select a color from the Color Palette.

Limits: Specifies the limit for the range.
The limit varies based on the selected data type. For details, refer to Chapter 2 "1.1 Available Data" on page 2-1.

Example: 180-degree meter, data minimum is 0, maximum is 100, the number of ranges is set to 5

The limit between range 1 and 2: 20

The limit between range 2 and 3: 40

The limit between range 3 and 4: 60

The limit between range 4 and 5: 80

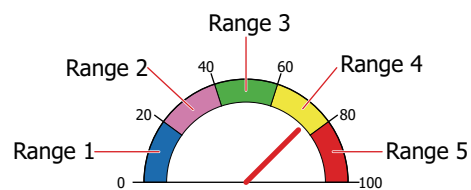

● Scale Tab

The **Scale** tab is displayed in Advanced mode.

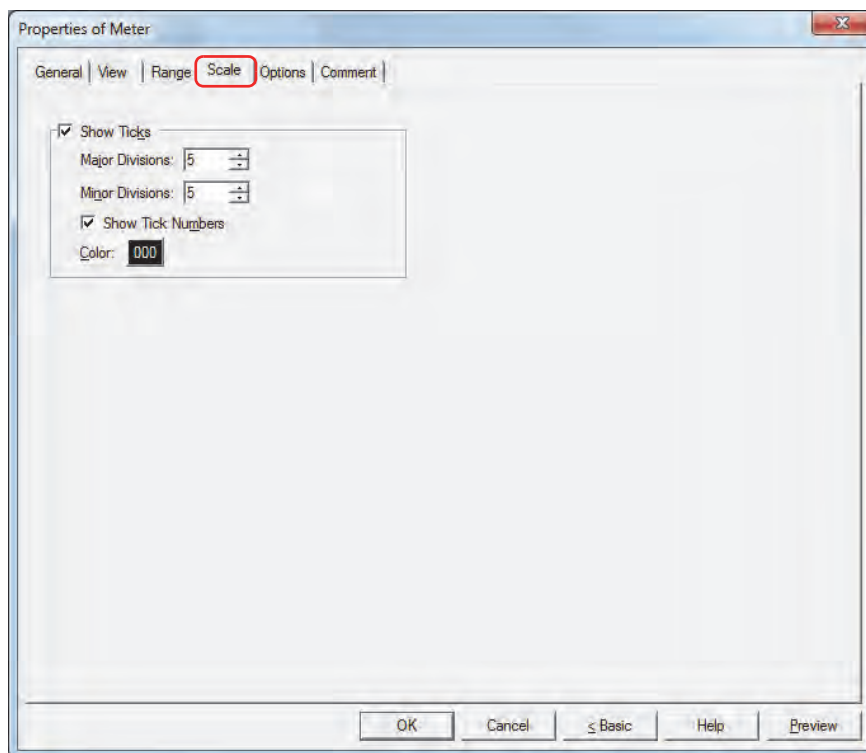

■ Show Ticks

Select this check box to display a scale on a or meter.

Major Divisions: Enter the number of major scale divisions (1 to 20).

Minor Divisions: Enter the number of minor scale divisions (1 to 20).

Show Tick Numbers: Select this check box to display numbers along the scale. The values are displayed in the same color as the scale.

Color: Selects the color of scales (color: 256 colors, monochrome: 8 shades).
Click the **Color** button to display the Color Palette. Select a color from the Color Palette.



If the area for displaying the scale is small, the scale will not be displayed properly.

● Options Tab

The **Options** tab is displayed in Advanced mode.

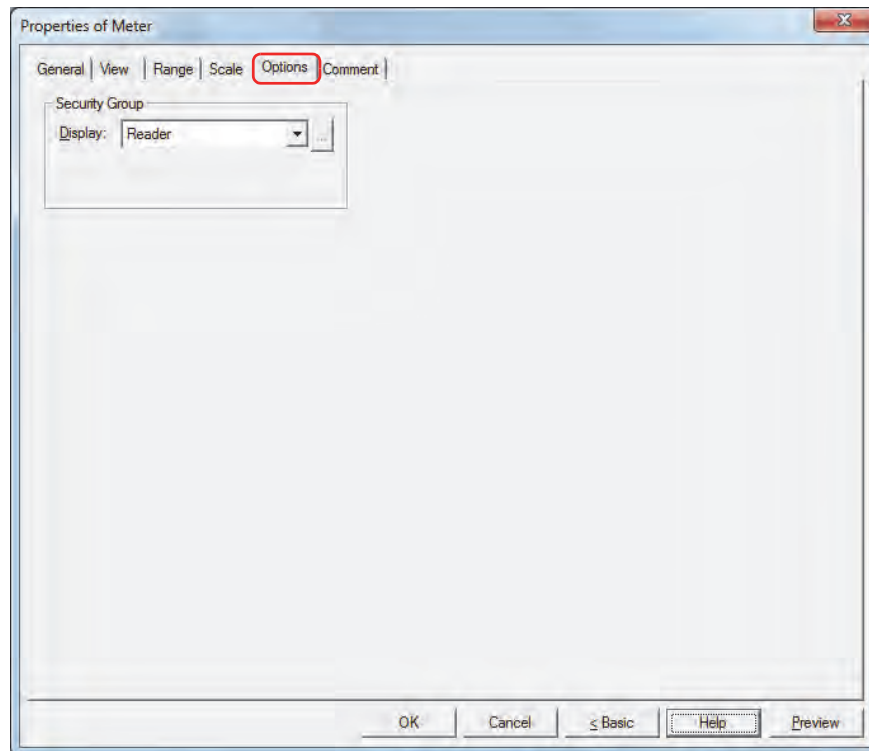

■ Security Group

Security groups are a security function for restricting the display and operation of parts.

Display: Selects the security group for which display of parts is restricted. (Default: None)

None: No security function is used.



Administrator, Operator, Reader: Three security groups are set up by default.

Click  to display the Security Group Settings dialog box. If you create a security group on the Security Group Settings dialog box, you can select that created group. For details, refer to Chapter 21 "2.2 Adding and Editing Security Groups" on page 21-15.



For details about security functions, refer to Chapter 21 "User Accounts and the Security Function" on page 21-1.

Example: If the user and security group for a part are set as follows:

User Name	 User1	 User2
Security Group	None	Group A

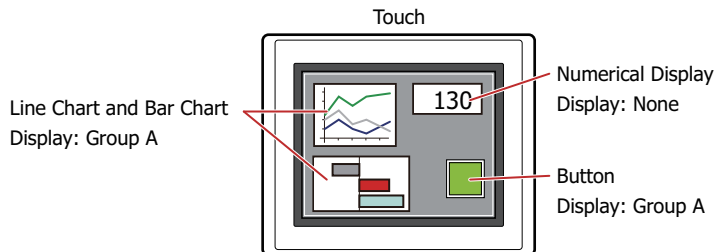

For User1, who is not included in the specified security group, Group A parts are not displayed. If the Password Screen is now opened and User2 logs in, Group A parts are displayed.

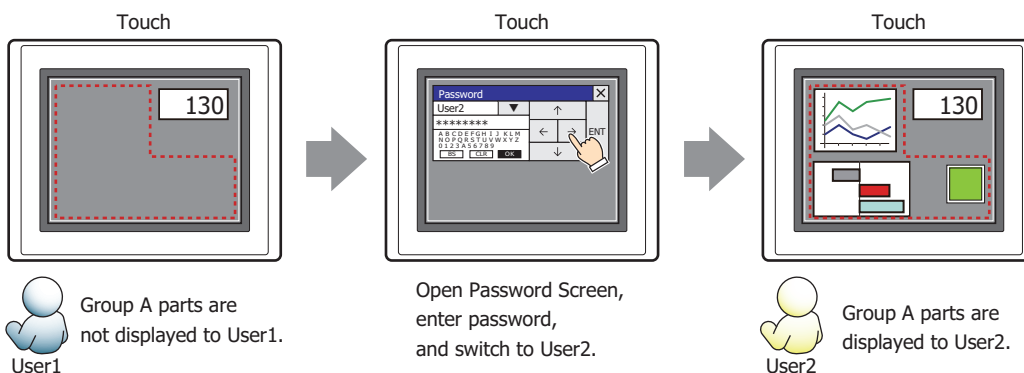

● Comment Tab

The **Comment** tab is used to specify the parts arranged on the editing screen, and the popup text displayed when the mouse pointer is placed close to **No.**, **Name**, or **Type** in the object list.



When there are multiple parts of the same shape on the screen, this feature makes it possible to distinguish between the parts without displaying the Properties dialog box for each part, by just mousing over the part.

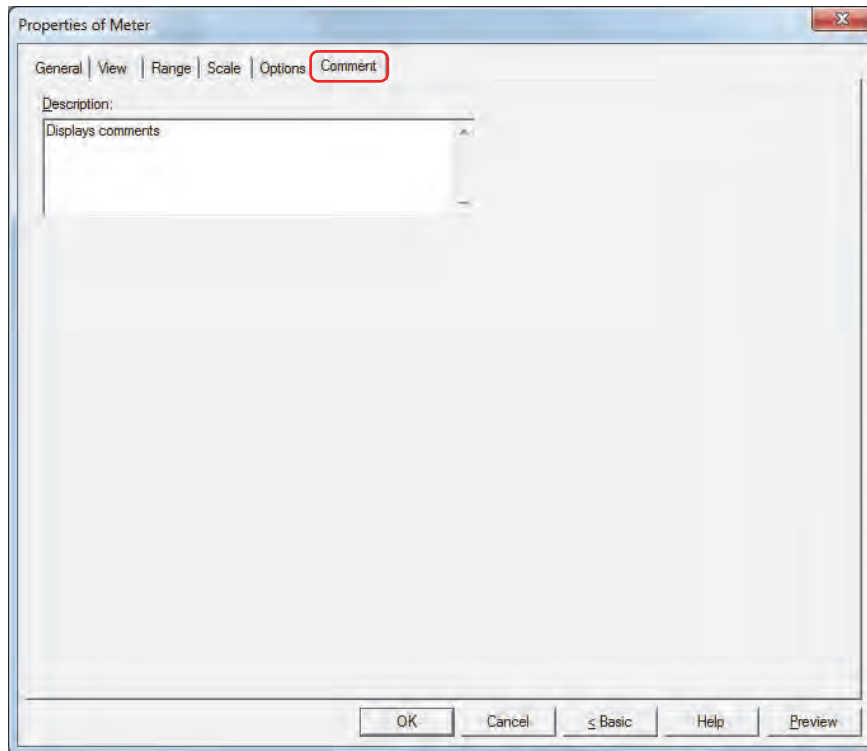

■ Description

Enter a comment about parts. The maximum number is 80 characters.

Example: When mousing over the meter on the editing screen

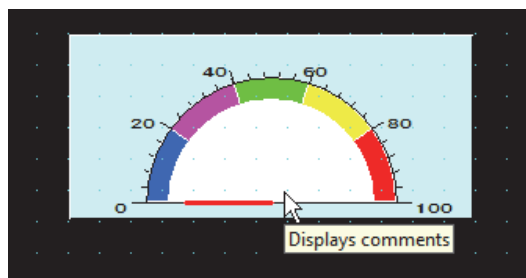

Chapter 11 Commands

This chapter describes how to setup commands and their operation on the Touch.

1 Bit Write Command

1.1 How the Bit Write Command is Used

Writes a 0 or 1 to a bit device.

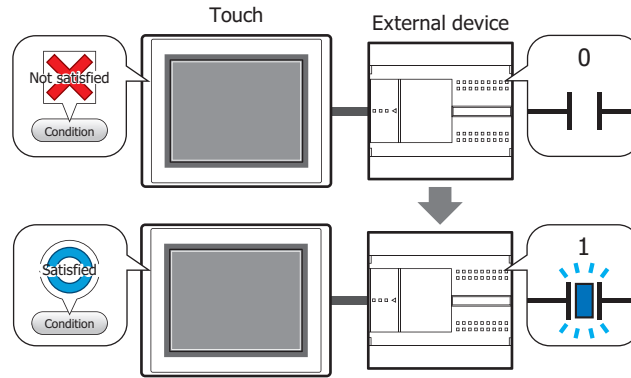

■ Set

Writes a 1 to the specified bit device when the trigger condition is satisfied.

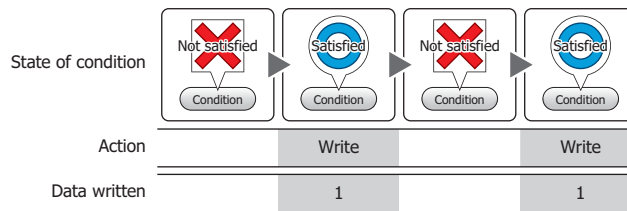

■ Reset

Writes a 0 to the specified bit device when the trigger condition is satisfied.

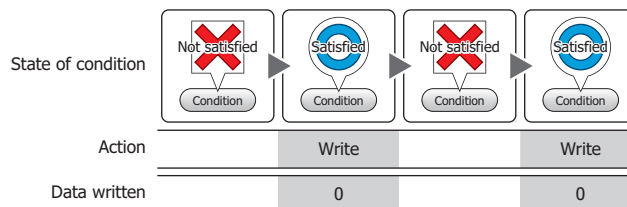

■ Momentary

Writes a 1 to the specified bit device when the trigger condition is satisfied.

When the trigger condition is no longer satisfied, a 0 is written to the specified bit device.

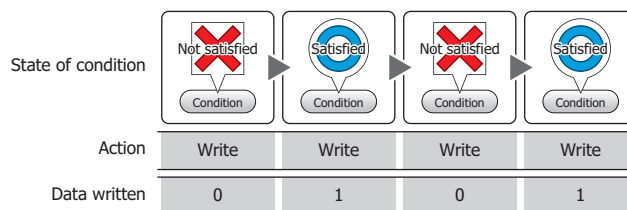

■ **Toggle**

Toggles the value of the specified bit device when the trigger condition is satisfied.

If the value of the bit device is 0 it changes to 1, and vice versa.

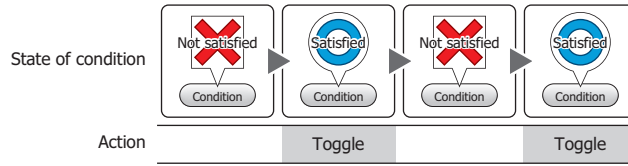

■ **Move**

This function writes the value in the source bit device to the value in the destination bit device when the trigger condition is satisfied.

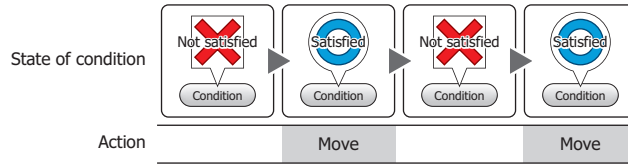

1.2 Bit Write Command Configuration Procedure

This section describes the configuration procedure for the Bit Write Command.

- 1 On the **Home** tab, in the **Parts** group, click **Commands**, and then click **Bit Write Command**.

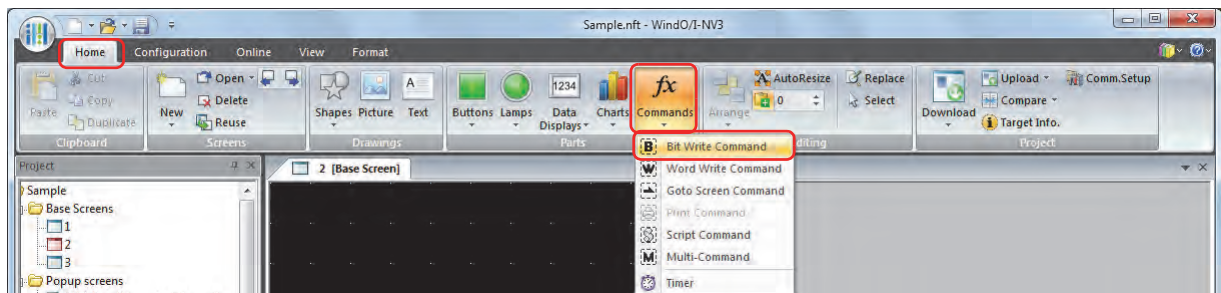

- 2 Click a point on the edit screen where you want to place the Bit Write Command.
- 3 Double-click the dropped Bit Write Command and a Properties dialog box will be displayed.
- 4 Change the settings on each tab as necessary.

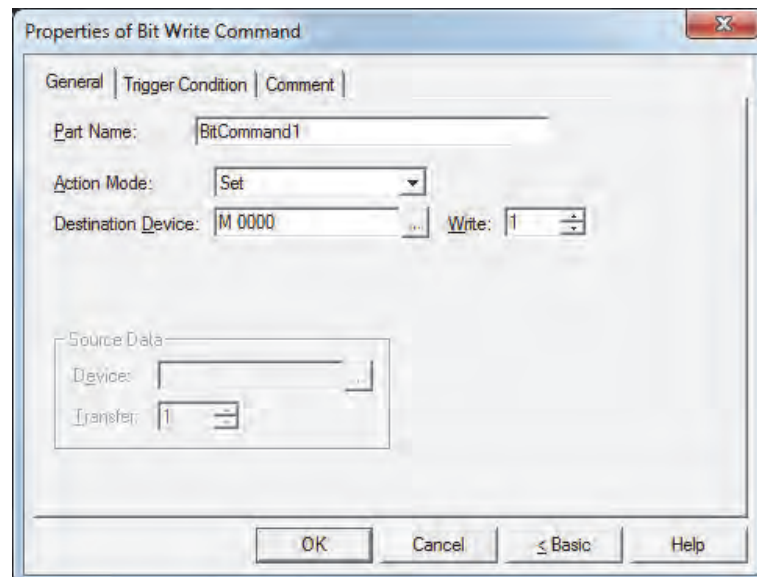

1.3 Properties of Bit Write Command Dialog Box

This section describes items and buttons in the Properties dialog box.

● **General Tab**

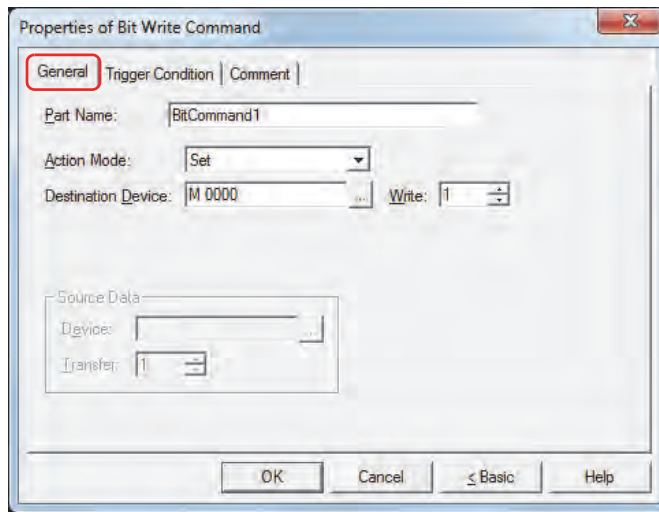

■ **Part Name**

Enter a name for the part. The maximum number is 20 characters.

■ **Action Mode**

Select the action to perform when the trigger condition is satisfied from the following:

Set: Writes a 1 to the specified bit device when the trigger condition is satisfied.

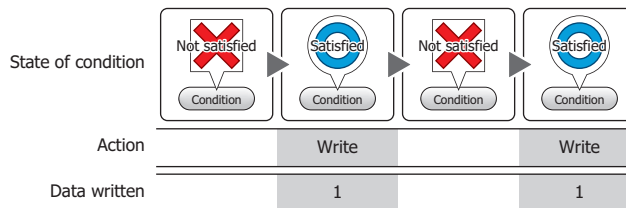

Reset: Writes a 0 to the specified bit device when the trigger condition is satisfied.

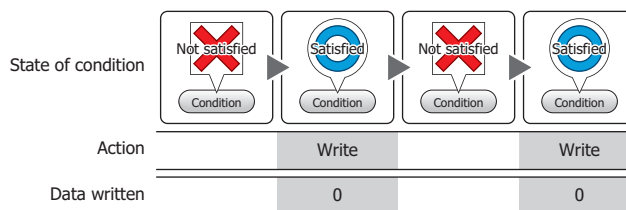

Momentary: Writes a 1 to the specified bit device when the trigger condition is satisfied. When the trigger condition is no longer satisfied, a 0 is written to the specified bit device.

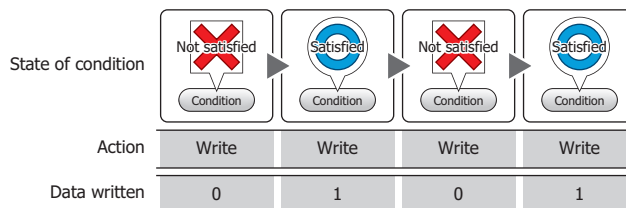

Toggle: Toggles the value of the specified bit device when the trigger condition is satisfied. If the value of the bit device is 0 it changes to 1, and vice versa.

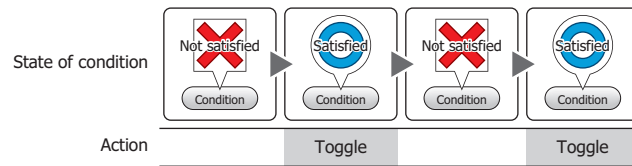

Move: This function writes the value in the source bit device to the value in the destination bit device when the trigger condition is satisfied.

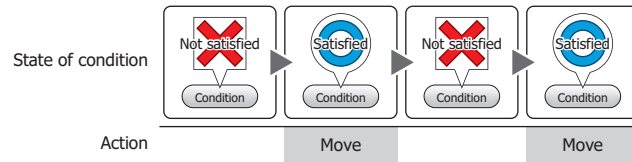

■ **Destination Device**

Specify the destination bit device.

Click to display the Device Address Settings dialog box. For the device address configuration procedure, refer to Chapter 2 “5.1 Device Address Settings” on page 2-61.

■ **Write**^{*1}

Specify the number of bit devices (1 to 64) at the destination.

This setting is enabled only if **Action Mode** is set to **Set** or **Reset**.

Example: This fills a contiguous block of bit devices with the same value.

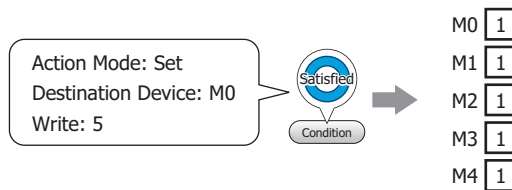

If the bit of the word device is specified, the same value is written to same bit of contiguous word devices.

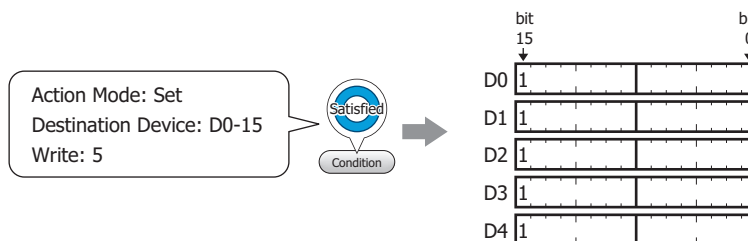

■ **Source Data**

Specifies the device where the data to be written is stored.

This setting is enabled only if **Action Mode** is set to **Move**.

Device: Specify the source bit device.

Click to display the Device Address Settings dialog box. For the device address configuration procedure, refer to Chapter 2 “5.1 Device Address Settings” on page 2-61.

Transfer: Specify the number of bit devices (1 to 64) to move.

Example: This button writes the values in a contiguous block of bit devices to a contiguous block of devices at the destination.

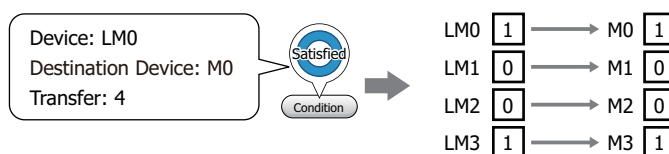

*1 Advanced mode only

● **Trigger Condition Tab**

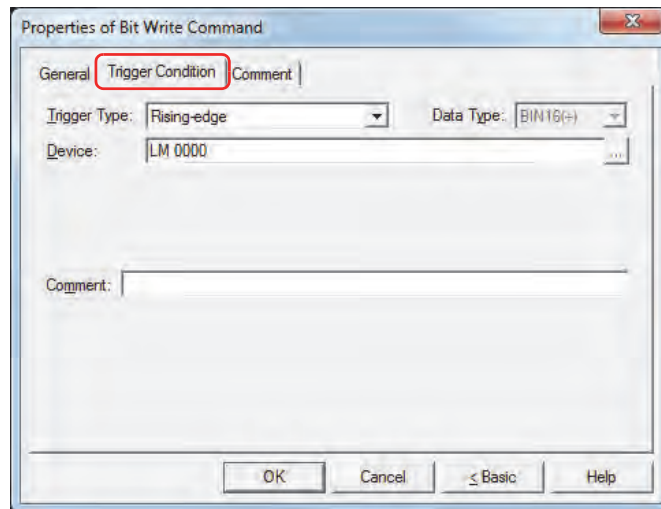

When the condition has been or is satisfied, the command is executed; when not satisfied, the command is not executed.

Example: When **Trigger Type** is **Rising-edge** and **Device** is LM0
 The command is executed when LM0 changes from 0 to 1.

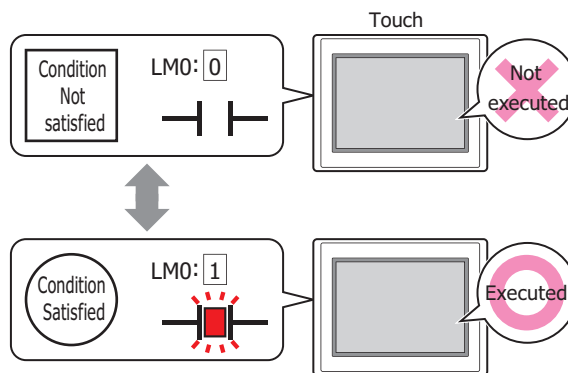

■ **Trigger Type**

Selects the condition to execute the command from the following.

Rising-edge: Command is executed when device changes from 0 to 1.

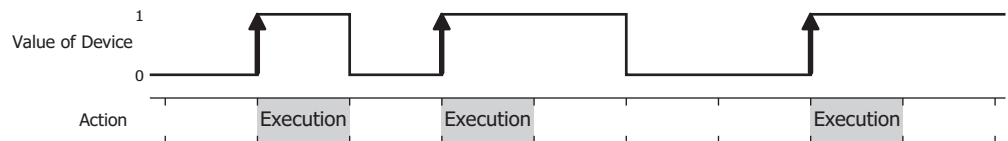

Falling-edge: Command is executed when device changes from 1 to 0.

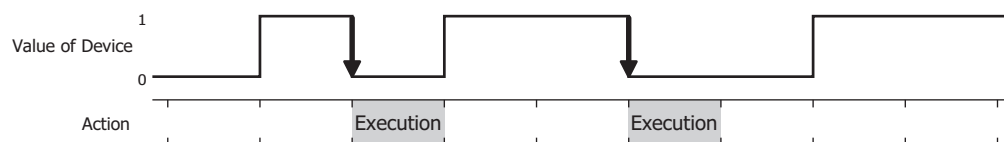

Satisfy the condition: Command is executed when condition changes from not satisfied to satisfied.

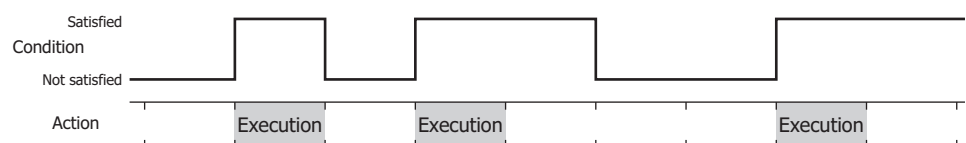

While satisfying the condition:

The command continues being executed while the condition is satisfied.

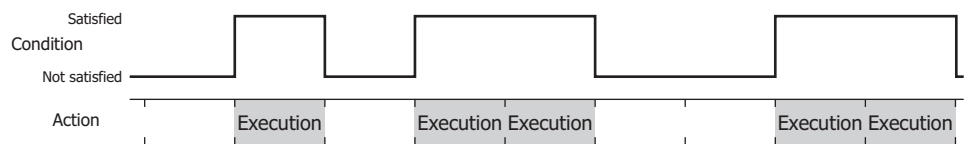

■ Data Type

Selects the data type to be handled by the condition formula.

Can only be set if **Satisfy the condition** or **While satisfying the condition** is selected as **Trigger Type**.

For details, refer to Chapter 2 “1.1 Available Data” on page 2-1.

■ Device

Specifies the bit device or bit of the word device to serve as condition.

Can only be set if **Rising-edge** or **Falling-edge** is selected as **Trigger Type**.

Click to display the Device Address Settings dialog box. For the device address configuration procedure, refer to Chapter 2 “5.1 Device Address Settings” on page 2-61.

■ Condition

Sets the condition formula.

Can only be set if **Satisfy the condition** or **While satisfying the condition** is selected as **Trigger Type**.

Click to display the Trigger Condition Settings dialog box. For the conditional expression configuration procedure, refer to Chapter 2 “5.2 Setting Conditional Expressions” on page 2-63.

■ Comment

Enter a comment about trigger conditions. The maximum number is 80 characters.

● Comment Tab

The **Comment** tab is used to specify the parts arranged on the editing screen, and the popup text displayed when the mouse pointer is placed close to **No.**, **Name**, or **Type** in the object list.



When there are multiple parts of the same shape on the screen, this feature makes it possible to distinguish between the parts without displaying the Properties dialog box for each part, by just mousing over the part.

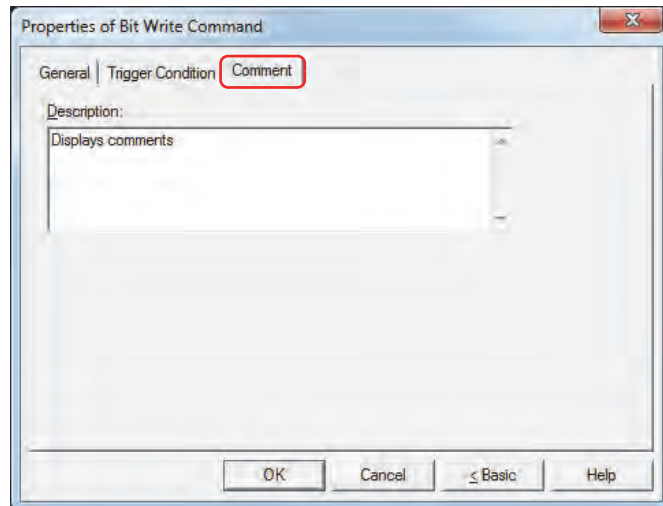

■ Description

Enter a comment about parts. The maximum number is 80 characters.

Example: When mousing over the Bit Write Command on the editing screen

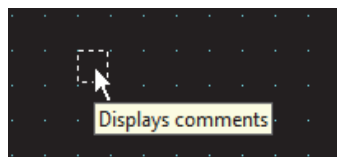

2 Word Write Command

2.1 How the Word Write Command is Used

Writes a value to a word device. Can be used to indirectly specify the destination address or to perform operations on the written value.

- Writes a fixed value to the specified word device when the trigger condition is satisfied.

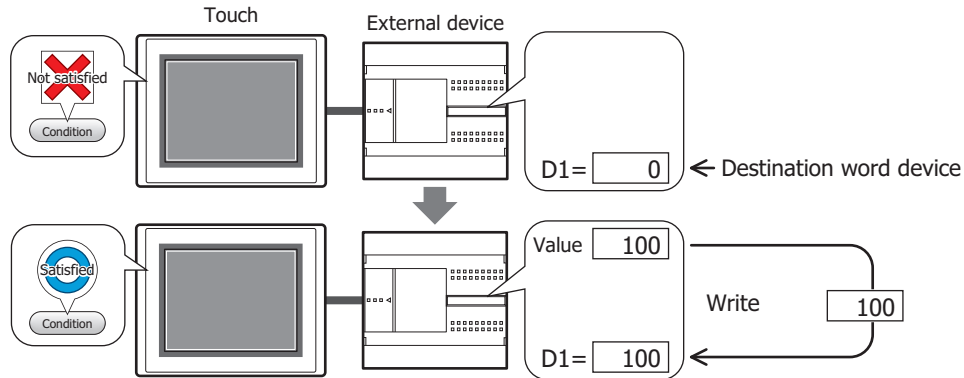

- Writes the value of device to the specified word device when the trigger condition is satisfied.

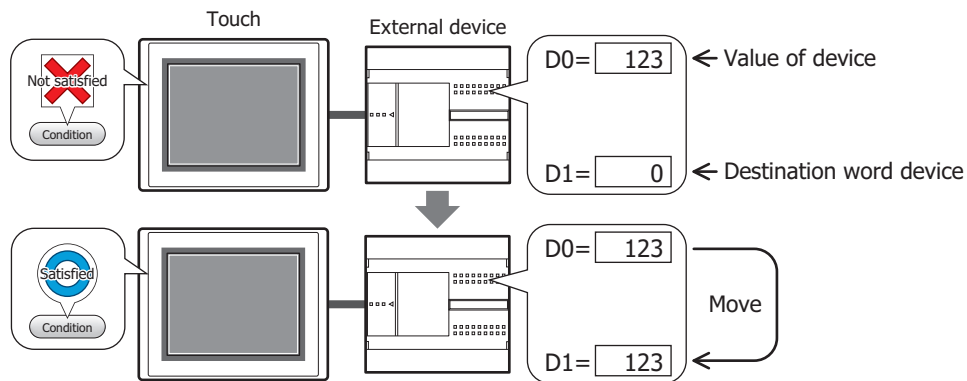

- Performs arithmetic on the value to write before writing it to a word device when the trigger condition is satisfied.

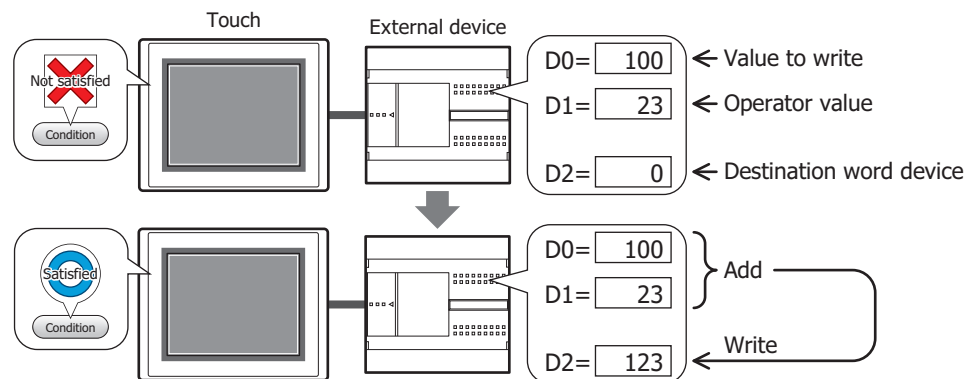

■ **Set**

Writes a fixed value to the specified word device when the trigger condition is satisfied.

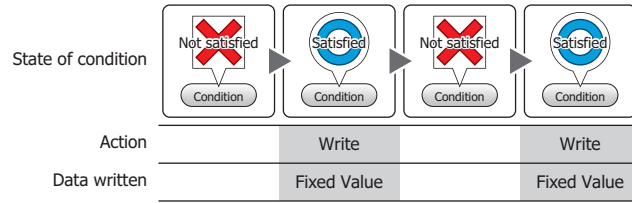

■ **Move**

Writes the value in the source device to the destination word device when the trigger condition is satisfied.

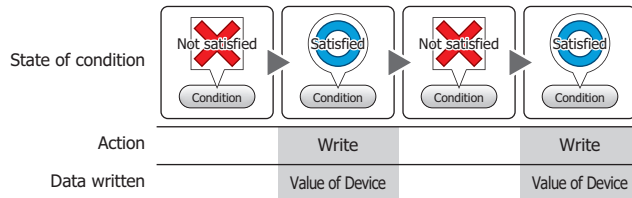

■ **Momentary**

Writes the fixed ON Data value to the specified word device when the trigger condition is satisfied.

Writes the fixed OFF Data value to the specified word device when the trigger condition is no longer satisfied.

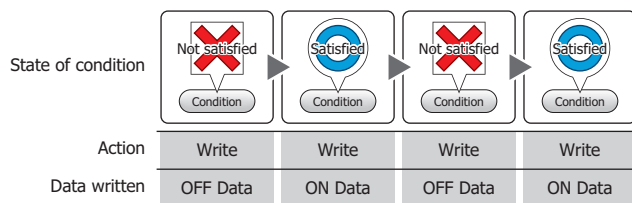

■ **Add, Sub, Multi, Div, Mod, OR, AND, XOR**

Performs arithmetic on the value in a source device and a fixed value or a value of device, and writes the result to a word device when the trigger condition is satisfied.

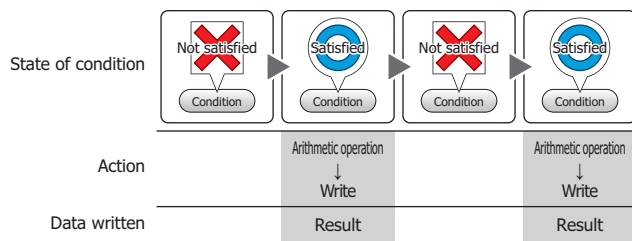

Example: Add (Addition)

When the trigger condition is satisfied, the value in the **Source 1** is added to the value in **Source 2** and the result is written to the word device.

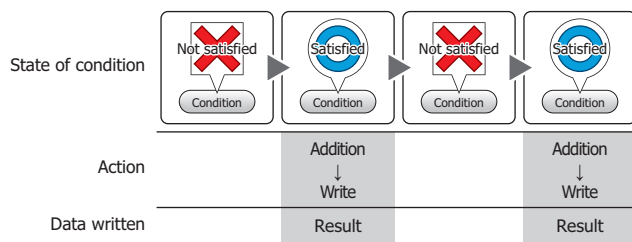

2.2 Word Write Command Configuration Procedure

This section describes the configuration procedure for the Word Write Command.

- 1 On the **Home** tab, in the **Parts** group, click **Commands**, and then click **Word Write Command**.

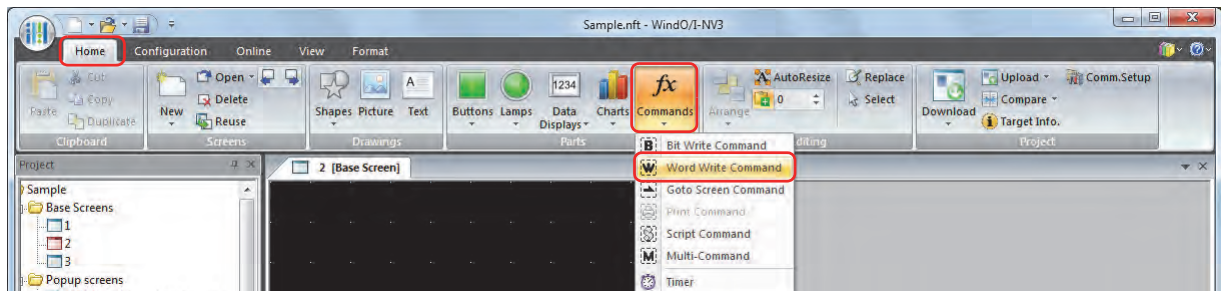

- 2 Click a point on the edit screen where you want to place the Word Write Command.
- 3 Double-click the dropped Word Write Command and a Properties dialog box will be displayed.
- 4 Change the settings on each tab as necessary.

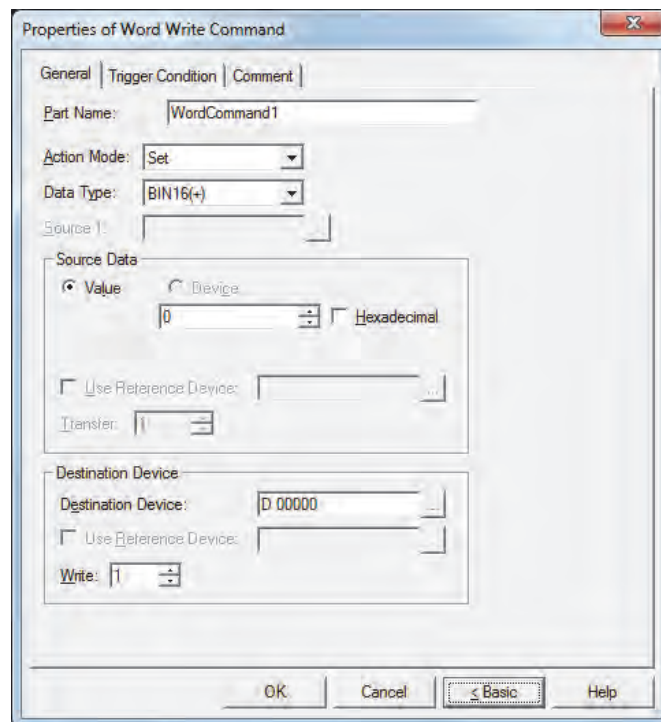

2.3 Properties of Word Write Command Dialog Box

This section describes items and buttons in the Properties dialog box.

● General Tab

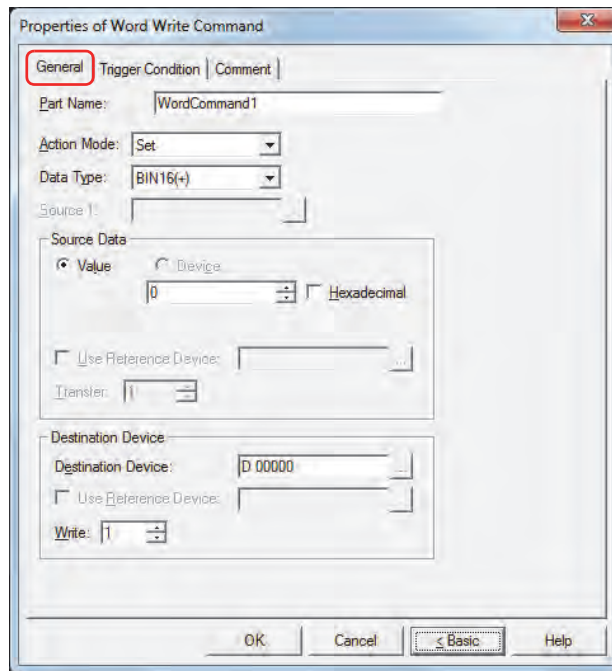

■ Part Name

Enter a name for the part. The maximum number is 20 characters.

■ Action Mode

Select the action to perform when the trigger condition is satisfied from the following:

Set: Writes a fixed value to the specified word device when the trigger condition is satisfied.

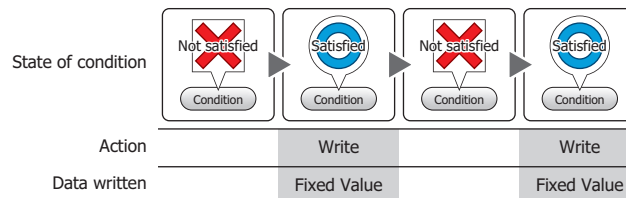

Move: Writes the value in the source device to the destination word device when the trigger condition is satisfied.

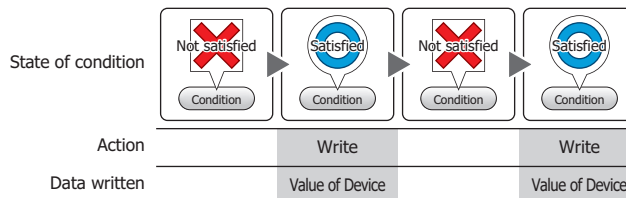

Momentary: Writes the fixed ON Data value to the specified word device when the trigger condition is satisfied. Writes the fixed OFF Data value to the specified word device when the trigger condition is no longer satisfied.

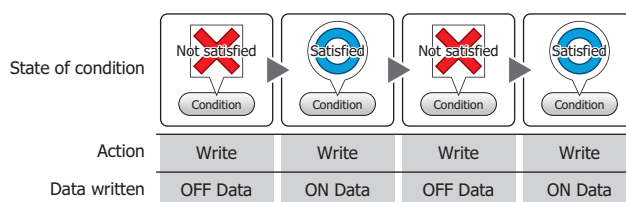

Add, Sub, Multi, Div, Mod, OR, AND, XOR:

Performs arithmetic on the value in a reference device and a fixed value, or the value at a device address and writes the result to a word device when the trigger condition is satisfied.

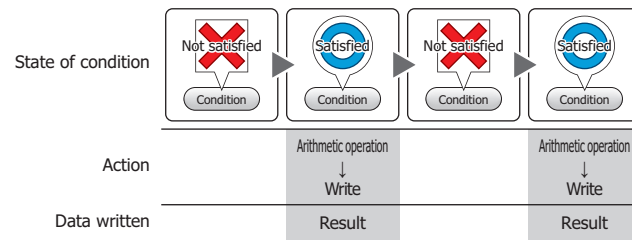

Example: Add (Addition)

When the trigger condition is satisfied, the value in the **Source 1** is added to the value in **Source 2** and the result is written to the word device.

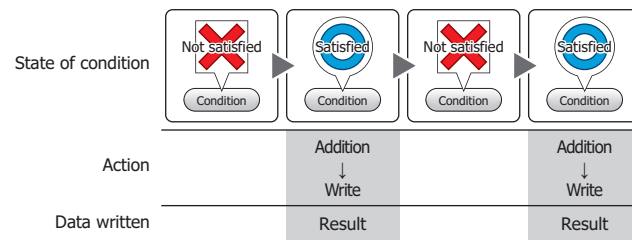

■ Data Type

Select the data type to be handled by the operation selected for **Action Mode**.

For details, refer to Chapter 2 "1.1 Available Data" on page 2-1.

BIN16(+) and **BIN32(+)** can only be set if **Action Mode** is set to **OR**, **AND**, or **XOR**.



BIN16(+) and **BIN32(+)** can only be set if **Action Mode** is set to **Move**. Because the number of devices to transfer is specified in Advanced mode, you do not need to set Data Type.



IF **BCD4**, **BCD8**, or **float32** is selected and the arithmetic data contains a value inexpressible in BCD, a 1 is written to System Area 2 Arithmetic error bit (address+2, bit 5) and an error message is displayed. For details, refer to Chapter 3 "Arithmetic error" on page 3-25.

■ Source 1

Specify the source word device.

Click to display the Device Address Settings dialog box. For the device address configuration procedure, refer to Chapter 2 "5.1 Device Address Settings" on page 2-61.

This setting is enabled only if **Action Mode** is set to **Add**, **Sub**, **Multi**, **Div**, **Mod**, **OR**, **AND**, or **XOR**.

■ Source Data

Select the data type to be handled by the operation selected for **Action Mode** and enter the value.

Value: Use a constant.

Only a **Value** can be handled if **Action Mode** is set to **Set** or **Momentary**.

If **Action Mode** is set to **Momentary**, the value in the **ON Data** is written when the trigger condition is satisfied, and the value in the **OFF Data** when the trigger condition is no longer satisfied.

Hexadecimal: Select this check box to enter the **ON Data** and **OFF Data** values as a hexadecimal.

Device: Use a word device.
Specify the device.

Click  to display the Device Address Settings dialog box. For the device address configuration procedure, refer to Chapter 2 “5.1 Device Address Settings” on page 2-61.

Use Reference Device^{*1}:

Select this check box and specify a device to change the source word device according to the value of the specified device.

This setting is enabled only if **Action Mode** is set to **Move**.

For details, refer to Chapter 2 “Indirect Read and Indirect Write Settings” on page 2-4.

Transfer^{*1}:

Specify the number of word devices (1 to 64) to move.

This setting is enabled only if **Action Mode** is set to **Move**.

Example: If **Transfer** is set to **2** and **Write** is set to **3**, the same data in 2 continuous word devices will be written to the destination device 3 times.

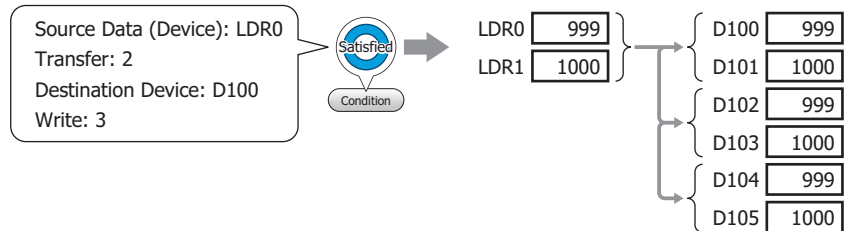

Destination Device

Destination Device: Specify the destination word device.

Click  to display the Device Address Settings dialog box. For the device address configuration procedure, refer to Chapter 2 “5.1 Device Address Settings” on page 2-61.

Use Reference Device^{*1}:

Select this check box and specify a device to change the destination word device according to the value of the specified device.

This setting is enabled only if **Action Mode** is set to **Move**.

For details, refer to Chapter 2 “Indirect Read and Indirect Write Settings” on page 2-4.

Write^{*1}:

Specify the number of word devices (1 to 64) at the destination.

For **Move**, specify how many times to repeat writing.

This setting is enabled only if **Action Mode** is set to **Set**, **Momentary**, **Alternate**, or **Move**.

Example: If **Data Type** is set to **BIN16(+)** and **Write** is set to 5, the same data will be written to 5 continuous word addresses.

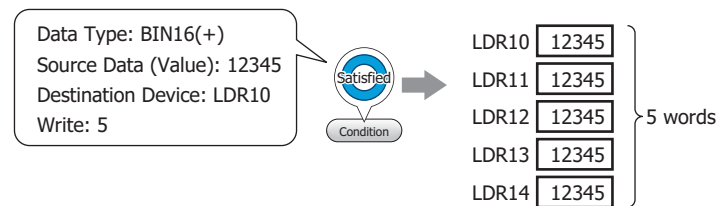

If **Data Type** is set to **BIN32(+)** and **Write** is set to 5, the same data will be written to a total of 10 word addresses (2 words 5 times).

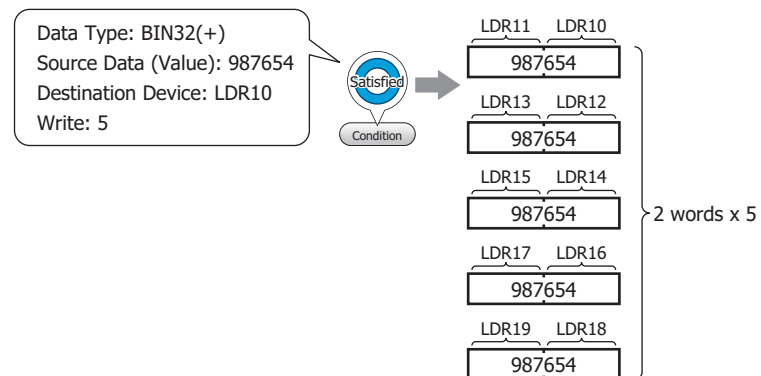

*1 Advanced mode only

● Trigger Condition Tab

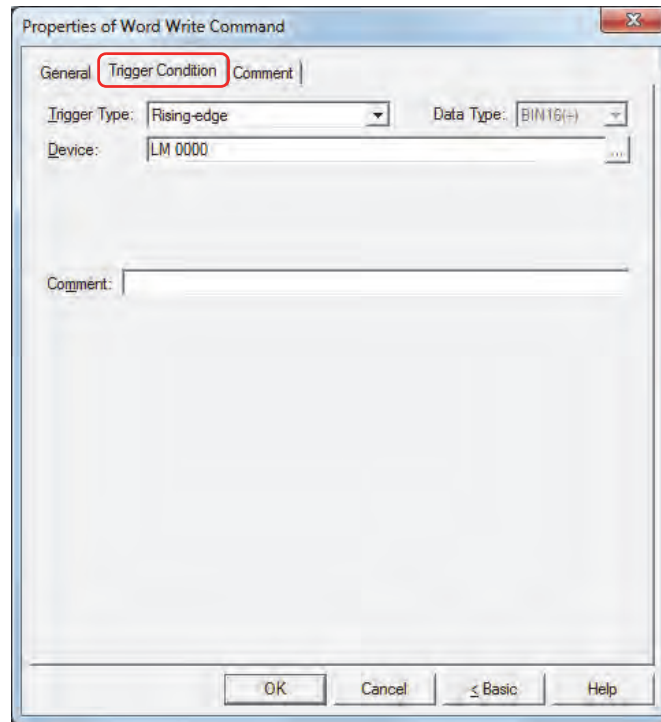

When the condition has been or is satisfied, the command is executed; when not satisfied, the command is not executed.

Example: When **Trigger Type** is **Rising-edge** and **Device** is LM0
The command is executed when LM0 changes from 0 to 1.

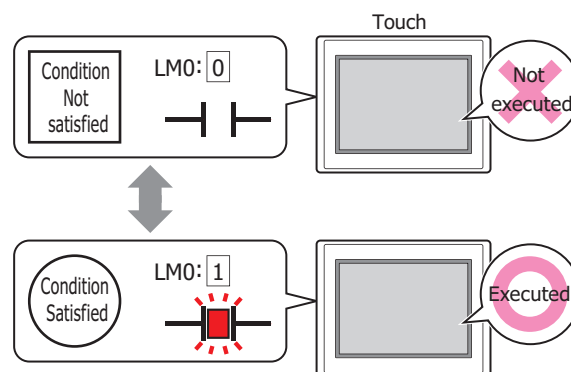

■ Trigger Type

Selects the condition to execute the command from the following.

Rising-edge:

Command is executed when device changes from 0 to 1.

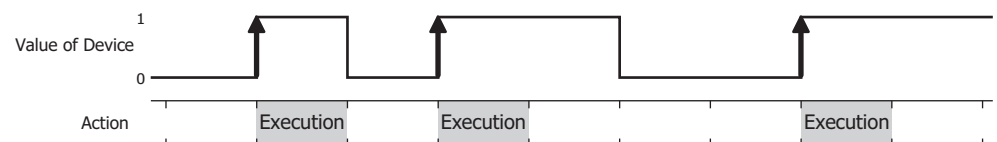

Falling-edge:

Command is executed when device changes from 1 to 0.

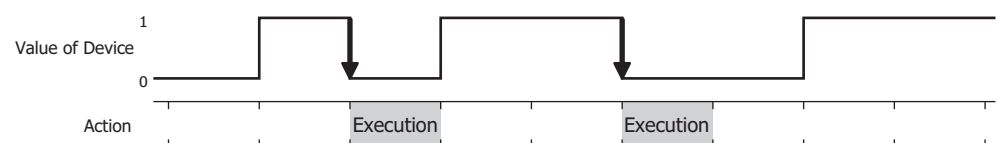

Satisfy the condition: Command is executed when condition changes from not satisfied to satisfied.

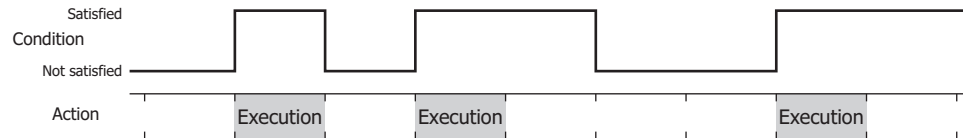

While satisfying the condition:

The command continues being executed while the condition is satisfied.

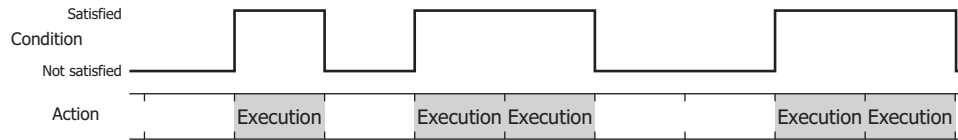

■ Data Type

Selects the data type to be handled by the condition formula.

Can only be set if **Satisfy the condition** or **While satisfying the condition** is selected as **Trigger Type**.

For details, refer to Chapter 2 "1.1 Available Data" on page 2-1.

■ Device

Specifies the bit device or bit of the word device to serve as condition.

Can only be set if **Rising-edge** or **Falling-edge** is selected as **Trigger Type**.

Click to display the Device Address Settings dialog box. For the device address configuration procedure, refer to Chapter 2 "5.1 Device Address Settings" on page 2-61.

■ Condition

Sets the condition formula.

Can only be set if **Satisfy the condition** or **While satisfying the condition** is selected as **Trigger Type**.

Click to display the Trigger Condition Settings dialog box. For the conditional expression configuration procedure, refer to Chapter 2 "5.2 Setting Conditional Expressions" on page 2-63.

■ Comment

Enter a comment about trigger conditions. The maximum number is 80 characters.

● Comment Tab

The **Comment** tab is used to specify the parts arranged on the editing screen, and the popup text displayed when the mouse pointer is placed close to **No.**, **Name**, or **Type** in the object list.



When there are multiple parts of the same shape on the screen, this feature makes it possible to distinguish between the parts without displaying the Properties dialog box for each part, by just mousing over the part.

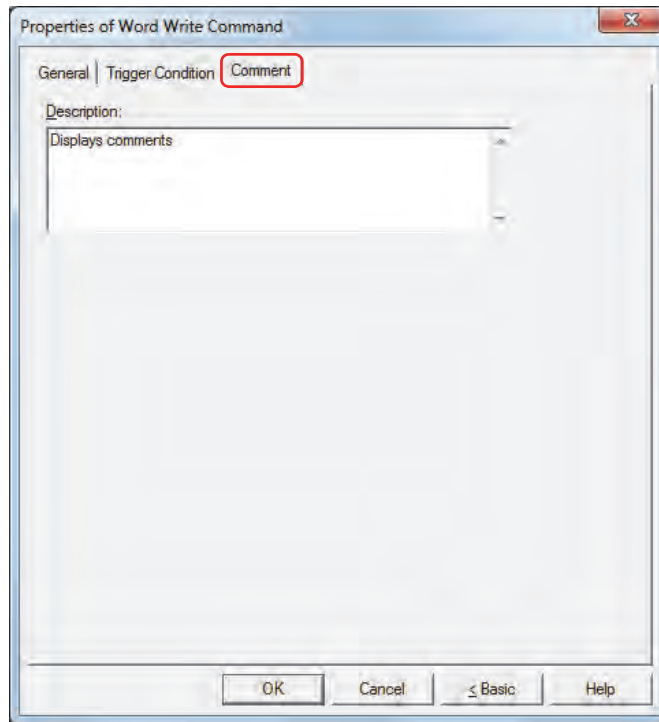

■ Description

Enter a comment about parts. The maximum number is 80 characters.

Example: When mousing over the Word Write Command on the editing screen

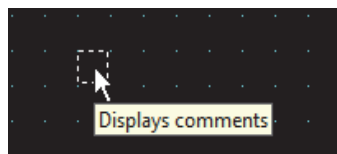

3 Goto Screen Command

3.1 How the Goto Screen Command is Used

Switches to another screen or displays a window.

- Switches between Base Screens when the trigger condition is satisfied.

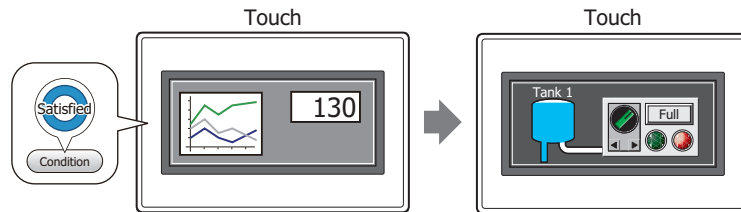

- Opens and closes other windows (such as the Popup Screen, Device Monitor, Ladder Monitor, Password Screen, and Adjust Contrast Screen) when the trigger condition is satisfied.

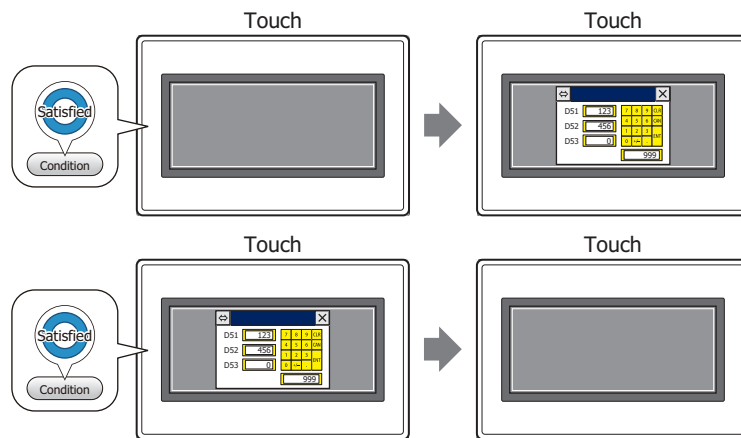

- Switches to the System Mode when the trigger condition is satisfied.

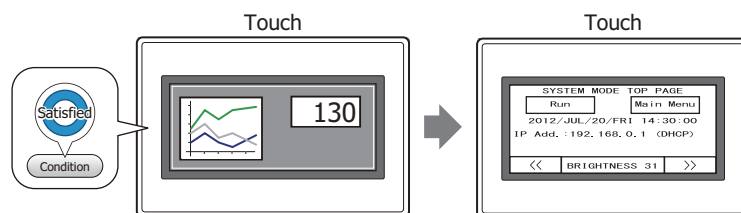

- Resets the current screen when the trigger condition is satisfied.

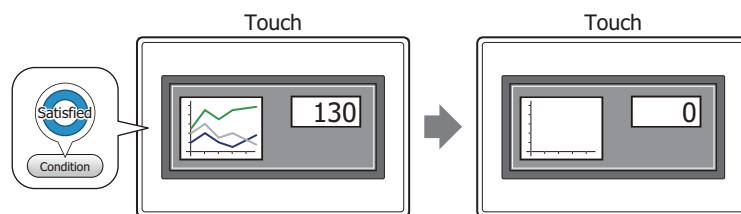

3.2 Goto Screen Command Configuration Procedure

This section describes the configuration procedure for the Goto Screen Command.

- 1 On the **Home** tab, in the **Parts** group, click **Commands**, and then click **Goto Screen Command**.

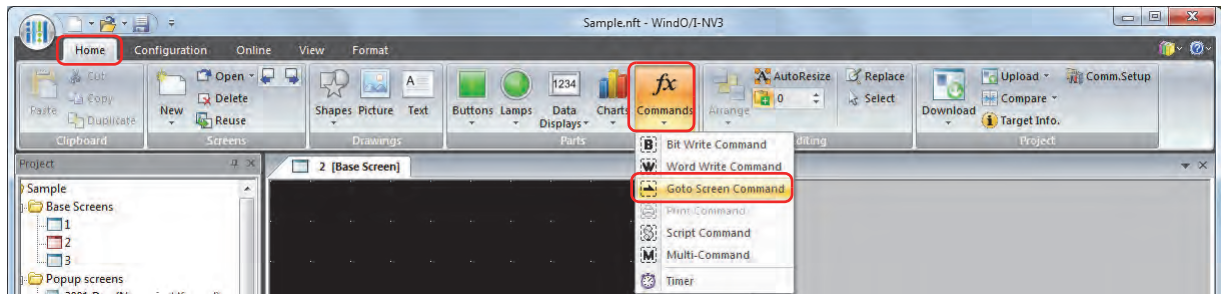

- 2 Click a point on the edit screen where you want to place the Goto Screen Command.
- 3 Double-click the dropped Goto Screen Command and a Properties dialog box will be displayed.
- 4 Change the settings on each tab as necessary.

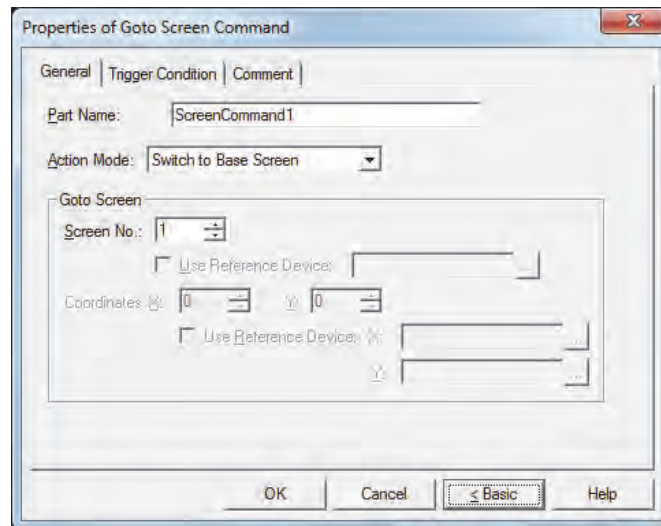

3.3 Properties of Goto Screen Command Dialog Box

This section describes items and buttons in the Properties dialog box.

● General Tab

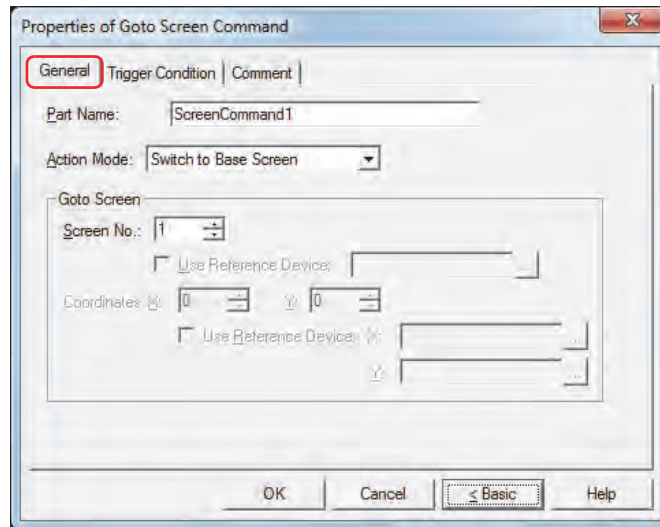

■ Part Name

Enter a name for the part. The maximum number is 20 characters.

■ Action Mode

Select the action to perform when the trigger condition is met from the following:

Back to previous Screen:	Switches to the previous screen. Returns to up to 16 earlier screens.
Switch to Base Screen:	Switches between Base Screen.
Open Popup Screen:	Opens a Popup Screen.
Close Popup Screen:	Closes a Popup Screen.
Open Device Monitor Screen:	Opens the Device Monitor Screen.
Close Device Monitor Screen:	Closes the Device Monitor Screen.
Open Ladder Monitor:	Opens the Ladder Monitor.
Close Ladder Monitor:	Closes the Ladder Monitor.
Open Password Screen:	Opens the Password Screen.
Close Password Screen:	Closes the Password Screen.
Open Adjust contrast Screen:	Opens the Adjust contrast Screen.
Close Adjust contrast Screen:	Closes the Adjust contrast Screen.
Switch to System Mode:	Switches to the Top Page in the System Mode.
Reset current screen:	Resets the current Base Screen.



- **Open Ladder Monitor** and **Close Ladder Monitor** can only operate when ladder program is selected as the programming language in control function.
- When the current Base Screen is reset using the **Reset current screen** function, the window and internal devices restart as if the Base Screens were switched.

■ Goto Screen

Screen No.: If **Action Mode** is set to **Switch to Base Screen**, specify the Base Screen number to switch to (from 1 to 3000). If **Action Mode** is set to **Open Popup Screen** or **Close Popup Screen**, specify the number of the Popup Screen to open or close (from 1 to 3015).

This setting is enabled only if **Action Mode** is set to **Switch to Base Screen**, **Open Popup Screen**, or **Close Popup Screen**.

Use Reference Device^{*1}: Select this check box and specify a device to specify the screen number using the value of the specified device.

Click to display the Device Address Settings dialog box. For the device address configuration procedure, refer to Chapter 2 "5.1 Device Address Settings" on page 2-61.

This setting is enabled only if **Action Mode** is set to **Open Popup Screen** or **Close Popup Screen**.

Coordinates X, Y: Specify the coordinates on the Base Screen for displaying a window.

X and Y specify the upper left corner of the window using the upper left corner of the screen as the origin.

This setting is enabled only if **Action Mode** is set to **Open Popup Screen**, **Open Device Monitor Screen**, **Open Password Screen**, **Open Adjust contrast Screen**, or **Open Movie File Screen**.

Use Reference Device^{*1}: Select this check box and specify a device to specify the coordinates using the value of the specified device.

Click to display the Device Address Settings dialog box. For the device address configuration procedure, refer to Chapter 2 "5.1 Device Address Settings" on page 2-61.

This setting is enabled only if **Action Mode** is set to **Open Popup Screen**.

*1 Advanced mode only

● **Trigger Condition Tab**

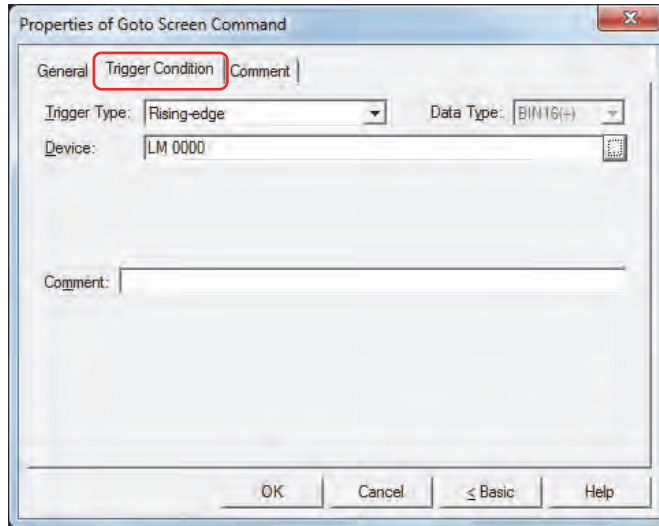

When the condition has been or is satisfied, the command is executed; when not satisfied, the command is not executed.

Example: When **Trigger Type** is **Rising-edge** and **Device** is LM0
 The command is executed when LM0 changes from 0 to 1.

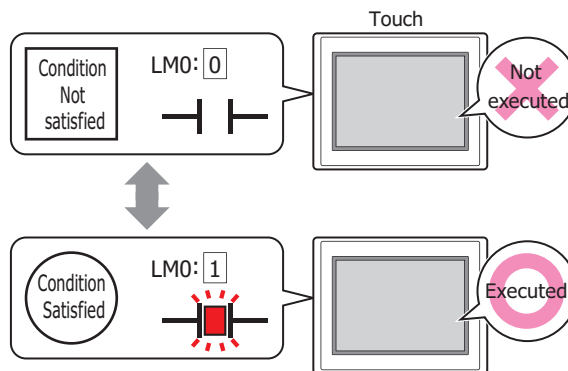

■ **Trigger Type**

Selects the condition to execute the command from the following.

Rising-edge:

Command is executed when device changes from 0 to 1.

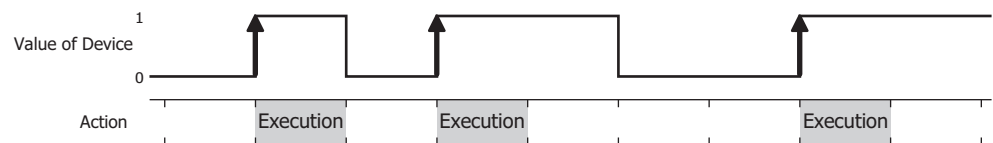

Falling-edge:

Command is executed when device changes from 1 to 0.



Satisfy the condition:

Command is executed when condition changes from not satisfied to satisfied.

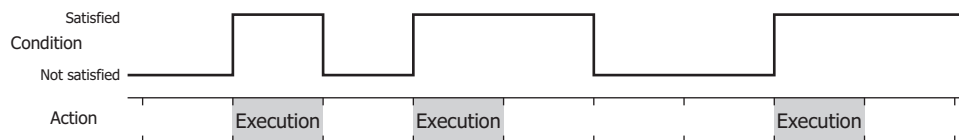

While satisfying the condition:

The command continues being executed while the condition is satisfied.

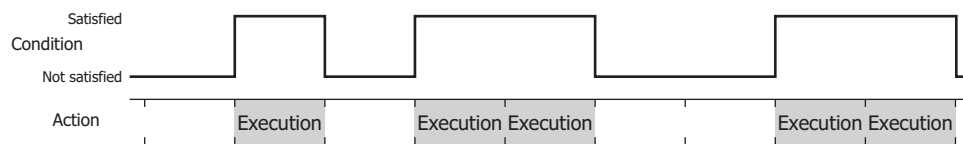

■ Data Type

Selects the data type to be handled by the condition formula.

Can only be set if **Satisfy the condition** or **While satisfying the condition** is selected as **Trigger Type**.

For details, refer to Chapter 2 "1.1 Available Data" on page 2-1.

■ Device

Specifies the bit device or bit of the word device to serve as condition.

Can only be set if **Rising-edge** or **Falling-edge** is selected as **Trigger Type**.

Click to display the Device Address Settings dialog box. For the device address configuration procedure, refer to Chapter 2 "5.1 Device Address Settings" on page 2-61.

■ Condition

Sets the condition formula.

Can only be set if **Satisfy the condition** or **While satisfying the condition** is selected as **Trigger Type**.

Click to display the Trigger Condition Settings dialog box. For the conditional expression configuration procedure, refer to Chapter 2 "5.2 Setting Conditional Expressions" on page 2-63.

■ Comment

Enter a comment about trigger conditions. The maximum number is 80 characters.

● Comment Tab

The **Comment** tab is used to specify the parts arranged on the editing screen, and the popup text displayed when the mouse pointer is placed close to **No.**, **Name**, or **Type** in the object list.



When there are multiple parts of the same shape on the screen, this feature makes it possible to distinguish between the parts without displaying the Properties dialog box for each part, by just mousing over the part.

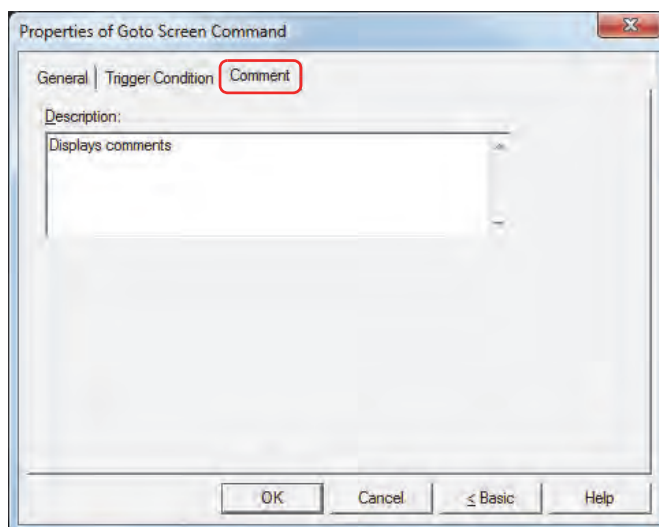

■ Description

Enter a comment about parts. The maximum number is 80 characters.

Example: When mousing over the Goto Screen Command on the editing screen

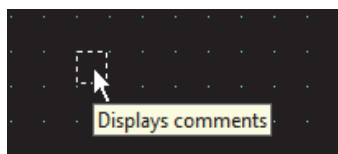

4 Script Command

4.1 How the Script Command is Used

Executes a script when certain conditions are satisfied.

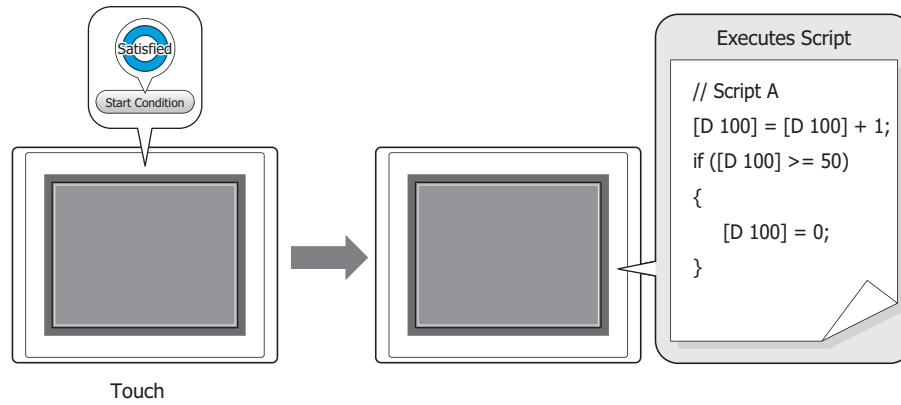

Complex processes such as conditional branching, logical operation, arithmetic operation, function, etc., can be programmed in a text format using Scripts. For details, refer to Chapter 20 "Script" on page 20-1.

4.2 Script Command Configuration Procedure

This section describes the configuration procedure for Script Commands.

- 1 On the **Home** tab, in the **Parts** group, click **Commands**, and then click **Script Command**.

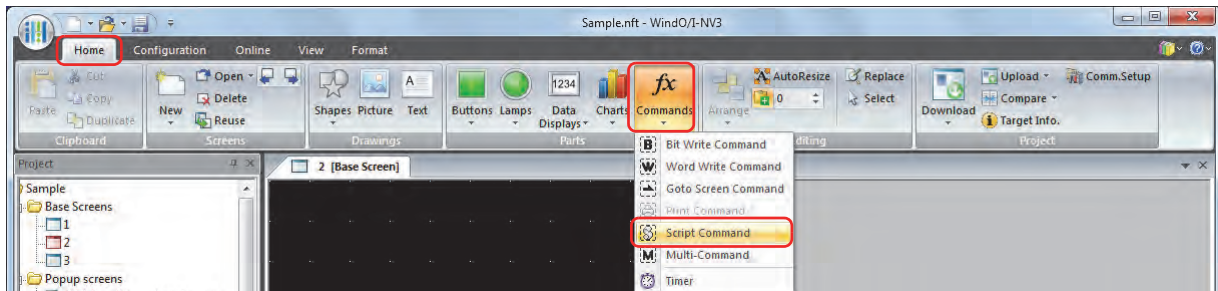

- 2 Click a point on the edit screen where you want to place the Script Command.
- 3 Double-click the dropped Script Command and a Properties dialog box will be displayed.
- 4 Change the settings on each tab as necessary.

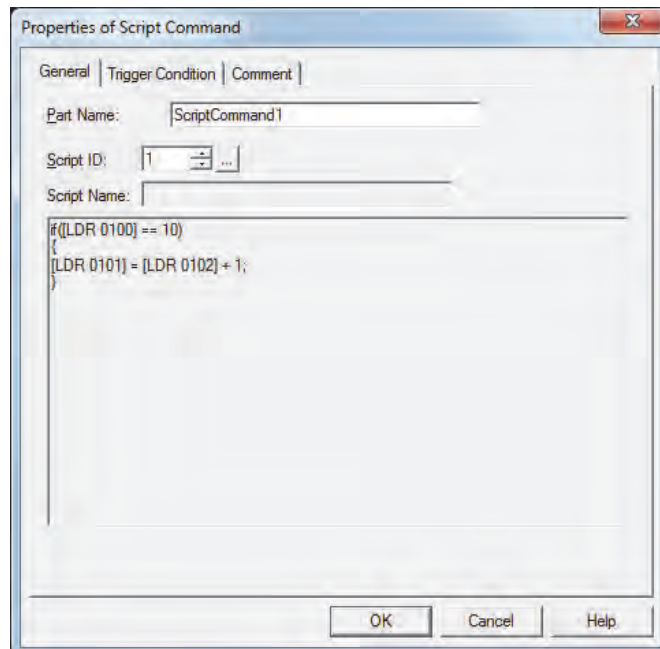

4.3 Properties of Script Command Dialog Box

This section describes items and buttons in the Properties dialog box.

● General Tab

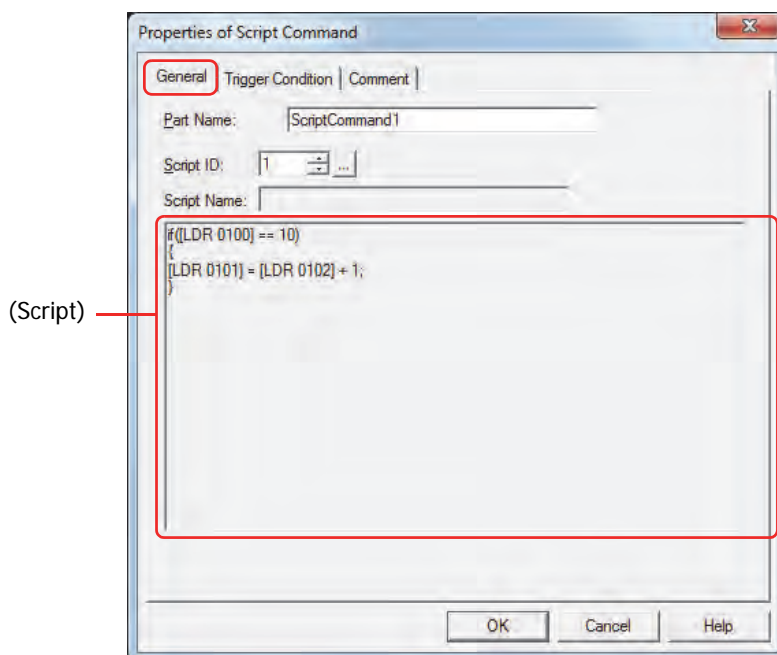

■ Part Name

Enter a name for the part. The maximum number is 20 characters.

■ Script ID

Specify the script ID (1 to 32000) of the script to operate.

Script Manager will open when is clicked. Select a script from the script list.

For details, refer to Chapter 20 "2.2 Script Manager" on page 20-7.

■ Script Name

Displays the name of the script selected in Script Manager.

■ (Script)

Displays the contents of the script selected in Script Manager.

Once this area is double clicked, the Script Editor will open and editing can be done.

For details, refer to Chapter 20 "2.3 Script Editor" on page 20-8.

● **Trigger Condition Tab**

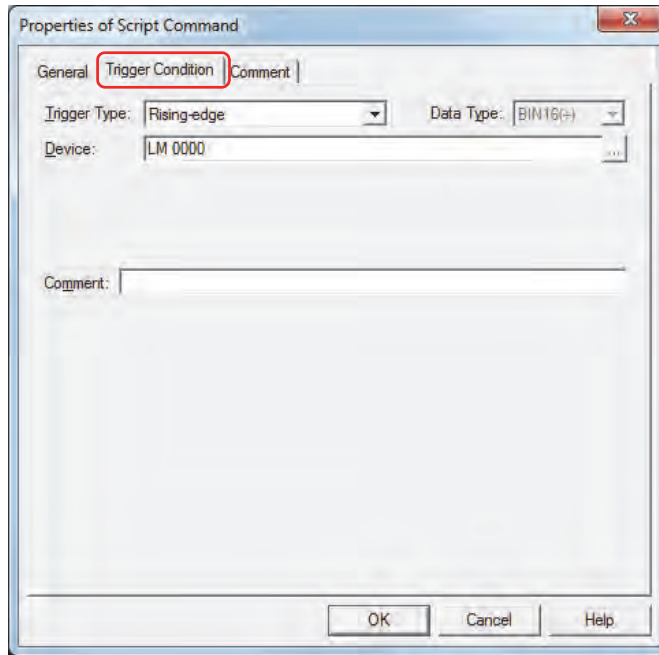

When the condition has been or is satisfied, the command is executed; when not satisfied, the command is not executed.

Example: When **Trigger Type** is **Rising-edge** and **Device** is LM0
 The command is executed when LM0 changes from 0 to 1.

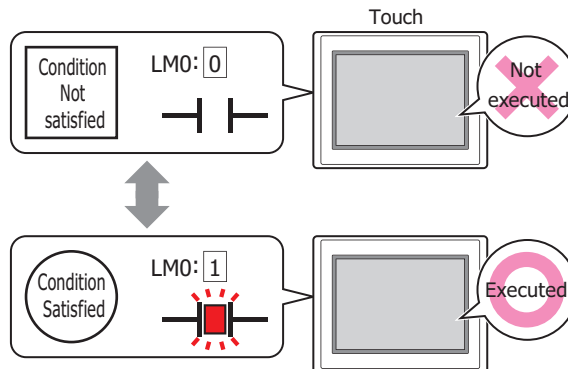

■ **Trigger Type**

Selects the condition to execute the command from the following.

Rising-edge: Command is executed when device changes from 0 to 1.

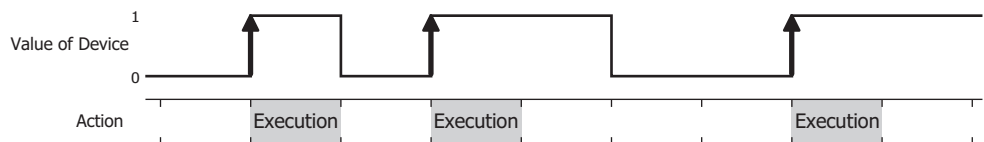

Falling-edge: Command is executed when device changes from 1 to 0.

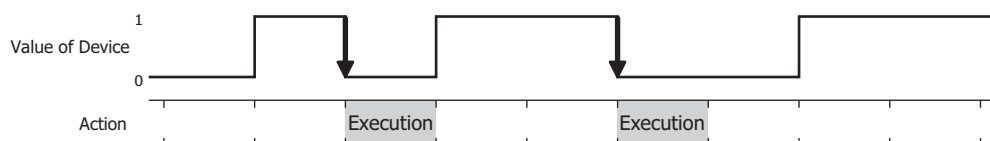

Satisfy the condition: Command is executed when condition changes from not satisfied to satisfied.

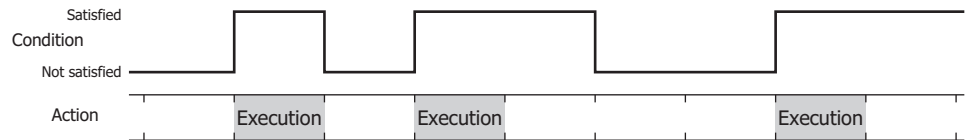

While satisfying the condition:

The command continues being executed while the condition is satisfied.

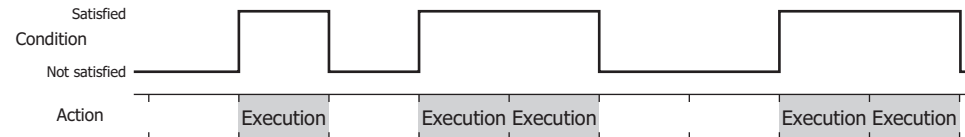

Fixed Period:

Command executes within a fixed time interval.

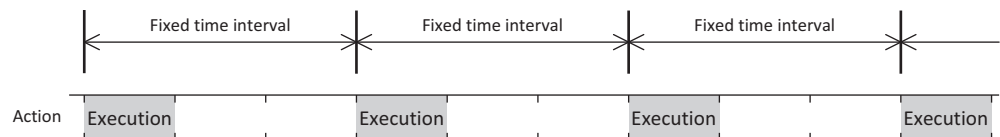

■ Data Type

Selects the data type to be handled by the condition formula.

Can only be set if **Satisfy the condition** or **While satisfying the condition** is selected as **Trigger Type**.

For details, refer to Chapter 2 "1.1 Available Data" on page 2-1.

■ Device

Specifies the bit device or bit of the word device to serve as condition.

Can only be set if **Rising-edge** or **Falling-edge** is selected as **Trigger Type**.

Click to display the Device Address Settings dialog box. For the device address configuration procedure, refer to Chapter 2 "5.1 Device Address Settings" on page 2-61.

■ Condition

Sets the condition formula.

Can only be set if **Satisfy the condition** or **While satisfying the condition** is selected as **Trigger Type**.

Click to display the Trigger Condition Settings dialog box. For the conditional expression configuration procedure, refer to Chapter 2 "5.2 Setting Conditional Expressions" on page 2-63.

■ Period

Sets the period for command execution from 1 to 3600 (seconds).

Can only be set if **Fixed Period** is selected as **Trigger Type**.

■ Comment

Enter a comment about trigger conditions. The maximum number is 80 characters.

● Comment Tab

The **Comment** tab is used to specify the parts arranged on the editing screen, and the popup text displayed when the mouse pointer is placed close to **No.**, **Name**, or **Type** in the object list.



When there are multiple parts of the same shape on the screen, this feature makes it possible to distinguish between the parts without displaying the Properties dialog box for each part, by just mousing over the part.

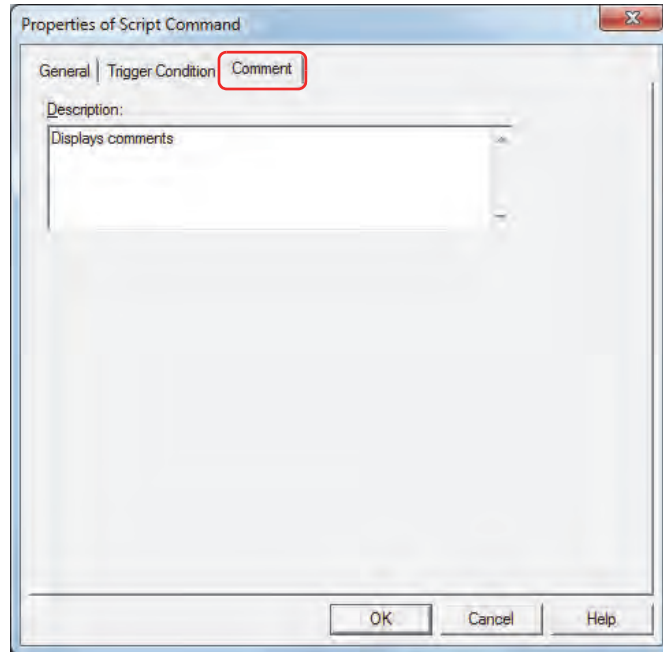

■ Description

Enter a comment about parts. The maximum number is 80 characters.

Example: When mousing over the Script Command on the editing screen

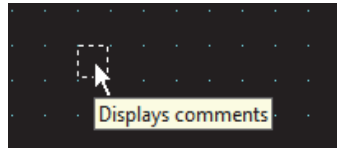

5 Multi-Command

5.1 How the Multi-Command is Used

Executes multiple commands at once.
These commands can be assigned to a Multi-Command.

Command	Description
Bit Write	Writes a 0 or 1 to the specified bit device.
Word Write	Writes a value to a word device. You can specify the destination address indirectly, and perform arithmetic on the value to be written.
Goto Screen	Switches screens or opens other windows.
Key	Performs downloads or uploads. Also used to manipulate other parts.
Script	Executes a script.

- Writes a 1 to a bit device, and the value in a word device to another device when the trigger condition is satisfied.

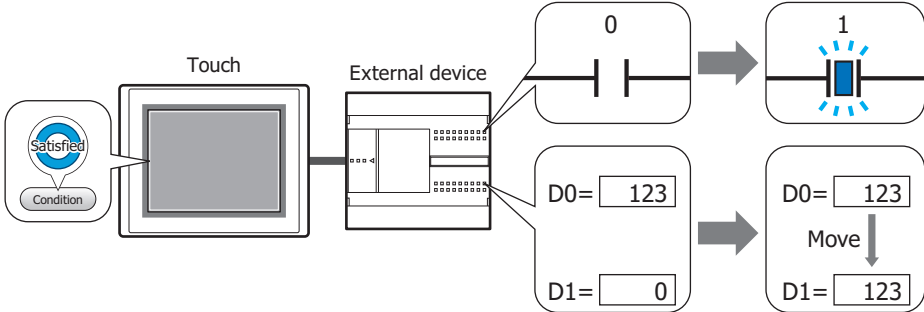

- When the trigger condition is satisfied, executes the script and switches the Base Screen.

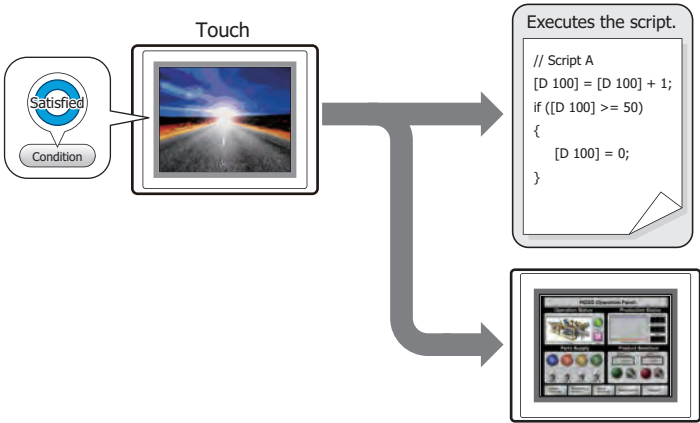

5.2 Multi-Command Configuration Procedure

This section describes the configuration procedure for Multi-Commands.

- 1 On the **Home** tab, in the **Parts** group, click **Commands**, and then click **Multi-Command**.

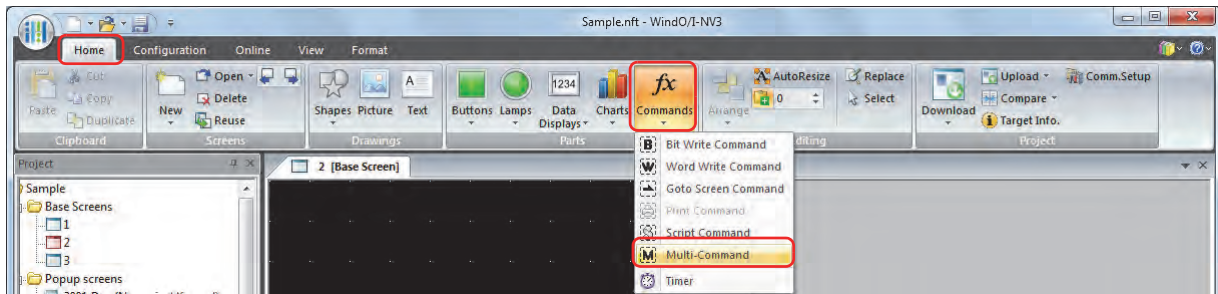

- 2 Click a point on the edit screen where you want to place the Multi-Command.
- 3 Double-click the dropped Multi-Command and a Properties dialog box will be displayed.
- 4 Change the settings on each tab as necessary.

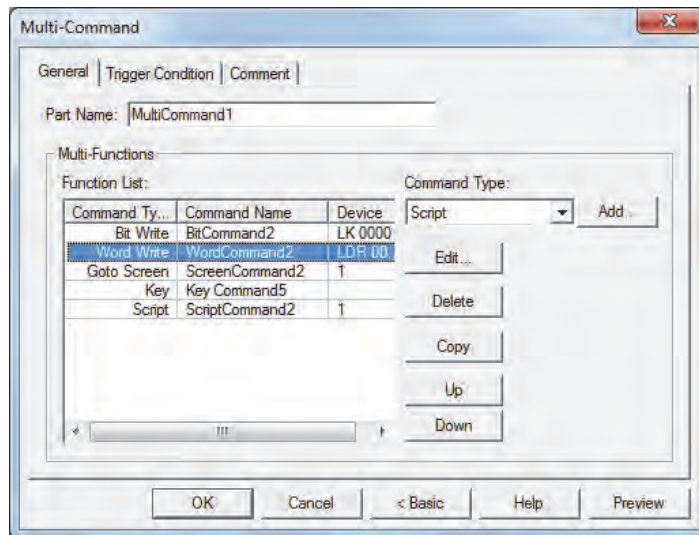

5.3 Properties of Multi-Command Dialog Box

This section describes items and buttons in the Properties dialog box.

● General Tab

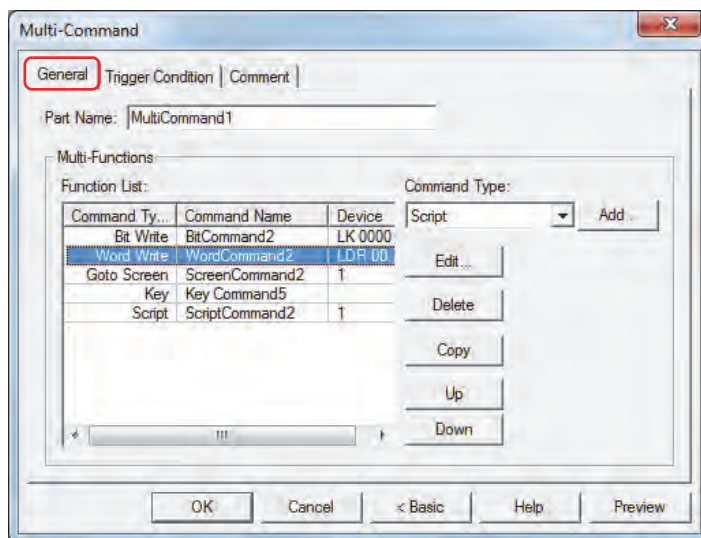

■ Part Name

Enter a name for the part. The maximum number is 20 characters.

■ Multi-Functions

Add and edit commands to be executed when the trigger condition is satisfied.

Function List: Lists the commands to be executed.

Command Type: Shows the command type.

Command Name: Shows the command name.

Device: Shows the setting when one of the following Command Type is selected.
Shows the destination device for the **Bit Write** and **Word Write** commands.
Shows the screen number when **Goto Screen** is set to **Switch to Base Screen**, **Open Popup Screen**, or **Close Popup Screen**.
Shows the script ID for the **Script** command.



- Executes only the Goto Screen command at the end of the **Function List** when multiple **Switch to Base Screen** type commands are set for **Action Mode**.
- Goto Screen commands are not executed from top to bottom as they appear in the **Function List**. Rather, they are executed at the end of the scan of the Touch when the trigger condition is satisfied.
- The function of Key button will affect on the next scan when the trigger condition is satisfied.
- If multiple Key commands are set, only the first and second Key commands in the **Function List** are executed. The third and following Key commands are not executed. Also, only the first Key command that specifies a Data Transfer function in the **Function List** is executed if multiple Key commands are set.

Command Type: Select the command to add.

Bit Write: Writes a 0 or 1 to a bit device or bit of the word device. For details, refer to "Properties of Bit Write for Multi-Functions dialog box" on page 11-35.

Word Write: Writes a value to a word device. Can be used to indirectly specify the destination address or to perform operations on the written value. For details, refer to "Properties of Word Write for Multi-Functions dialog box" on page 11-36.

Goto Screen: Switches to another screen or displays a window. For details, refer to "Properties of Goto Screen for Multi-Functions dialog box" on page 11-38.

- Key: Performs a variety of functions including uploading and downloading, copying files, and operating other parts. For details, refer to "Properties of Key for Multi-Functions dialog box" on page 11-40.
- Script: Executes a script. For details, refer to "Properties of Script for Multi-Functions dialog box" on page 11-42.
- Add: Adds a command to the list. A maximum of 32 commands may be added.
Click this button to display the Properties dialog box for the command selected from **Command Type**.
- Edit: Changes a command in the list.
Click this button to display the Properties dialog box for the command selected in **Function List**.
- Delete: Deletes a command from the list.
Select the command in the list, and then click this button.
- Copy: Copies a command in the list.
Select a command in the list, and then click this button. A copy of the selected command is added to the end of the list.
- Up: Shifts the selected command upward in the list.
- Down: Shifts the selected command downward in the list.

Properties of Bit Write for Multi-Functions dialog box

Sets the Bit Write command for the Multi-Command.

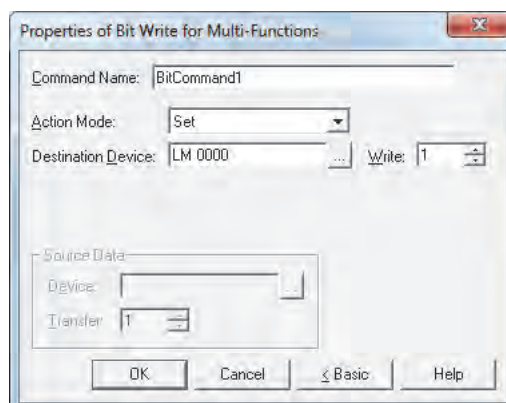

■ Command Name

Enter a name for the command. The maximum number is 20 characters.

■ Action Mode

Select the action to perform when the trigger condition is satisfied from the following:

- Set: Writes a 1 to the specified bit device when the trigger condition is satisfied.
- Reset: Writes a 0 to the specified bit device when the trigger condition is satisfied.
- Set & Reset: Writes a 1 to the specified bit device when the trigger condition is satisfied. When the trigger condition is no longer satisfied, a 0 is written to the specified bit device.
- Toggle: Toggles the value of the specified bit device when the trigger condition is satisfied. If the value of the bit device is 0 it changes to 1, and vice versa.
- Move: This function writes the value in the source bit device to the value in the destination bit device when the trigger condition is satisfied.



For details about the **Action Mode**, refer to “Action Mode” on page 11-4. However, **Set & Reset** for the Multi-Command has the same function as **Momentary** for the Bit Write Command.

■ Destination Device

Specify the destination bit device.

Click to display the Device Address Settings dialog box. For the device address configuration procedure, refer to Chapter 2 “5.1 Device Address Settings” on page 2-61.

■ Write*1

Specify the number of bit devices (1 to 64) at the destination.

This setting is enabled only if **Action Mode** is set to **Set** or **Reset**. For details, refer to “Write” on page 11-5.

■ Source Data

Specifies the device where the data to be written is stored.

This setting is enabled only if **Action Mode** is set to **Move**. For details, refer to “Source Data” on page 11-5.

Device: Specify the source bit device.

Click to display the Device Address Settings dialog box. For the device address configuration procedure, refer to Chapter 2 “5.1 Device Address Settings” on page 2-61.

Transfer: Specify the number of bit devices (1 to 64) to move.

*1 Advanced mode only

Properties of Word Write for Multi-Functions dialog box

Sets the Word Write command for the Multi-Command.

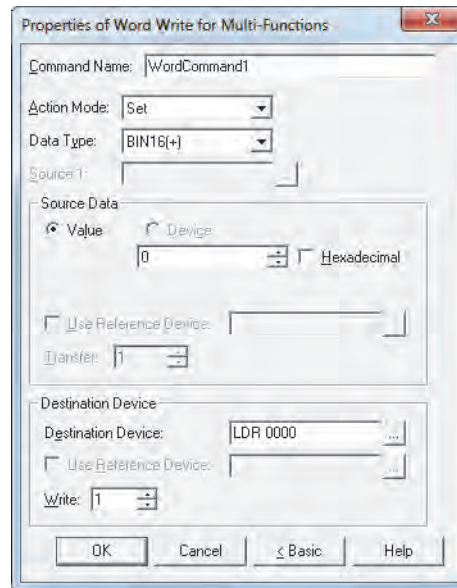

■ Command Name

Enter a name for the command. The maximum number is 20 characters.

■ Action Mode

Select the action to perform when the trigger condition is satisfied from the following:

Set: Writes a fixed value to the specified word device when the trigger condition is satisfied.

Move: Writes the value in the source device to the destination word device when the trigger condition is satisfied.

Set ON & OFF Data: Writes a fixed value of ON Data to the specified word device when the trigger condition is satisfied.

Writes a fixed value of OFF Data to the specified word device when the trigger condition is no longer satisfied.

Add, Sub, Multi, Div, Mod, OR, AND, XOR:

Performs arithmetic on the value in a source device and a fixed value or a value of device, and writes the result to a word device when the trigger condition is satisfied.



For details about the **Action Mode**, refer to "Action Mode" on page 11-12. However, **Set ON & OFF Data** for the Multi-Command has the same function as **Momentary** for the Word Write Command.

■ Data Type

Select the data type handled by the operation selected for **Action Mode**.

For details, refer to Chapter 2 "1.1 Available Data" on page 2-1.

BIN16(+) and **BIN32(+)** can only be set if **Action Mode** is set to **OR**, **AND**, or **XOR**.



BIN16(+) and **BIN32(+)** can only be set if **Action Mode** is set to **Move**. Because the number of devices to transfer is specified in Advanced mode, you do not need to set Data Type.



If **BCD4**, **BCD8**, or **float32** is selected and the arithmetic data contains a value inexpressible in BCD, a 1 is written to System Area 2 Arithmetic error bit (address+2, bit 5) and an error message is displayed.

For details, refer to Chapter 3 "Arithmetic error" on page 3-25.

■ Source 1

Specify the source word device.

Click  to display the Device Address Settings dialog box. For the device address configuration procedure, refer to Chapter 2 "5.1 Device Address Settings" on page 2-61.

This setting is enabled only if **Action Mode** is set to **Add**, **Sub**, **Multi**, **Div**, **Mod**, **OR**, **AND**, or **XOR**.

■ Source Data

Select the data handled by the operation selected for **Action Mode**.

Value: Use a constant.

Only a **Value** can be handled if **Action Mode** is set to **Set** or **Set ON & OFF Data**.

If **Action Mode** is set to **Set ON & OFF Data**, the value in the **ON Data** is written when the trigger condition is satisfied, and the value in the **OFF Data** when the trigger condition is no longer satisfied.

Hexadecimal: Select this check box to enter the **ON Data** and **OFF Data** values as a hexadecimal.

Device: Use a word device.

Specify the device.

Click to display the Device Address Settings dialog box. For the device address configuration procedure, refer to Chapter 2 "5.1 Device Address Settings" on page 2-61.

Use Reference Device^{*1}: Select this check box and specify a device to change the source word device according to the value of the specified device.

This setting is enabled only if **Action Mode** is set to **Move**.

For details, refer to Chapter 2 "Indirect Read and Indirect Write Settings" on page 2-4.

Transfer^{*1}: Specify the number of word devices (1 to 64) to move.

This setting is enabled only if **Action Mode** is set to **Move**.

For details, refer to "Transfer" on page 11-14.

■ Destination Device

Destination Device: Specify the destination word device.

Click to display the Device Address Settings dialog box. For the device address configuration procedure, refer to Chapter 2 "5.1 Device Address Settings" on page 2-61.

Use Reference Device^{*1}: Select this check box and specify a device to change the destination word device according to the value of the specified device.

This setting is enabled only if **Action Mode** is set to **Move**.

For details, refer to Chapter 2 "Indirect Read and Indirect Write Settings" on page 2-4.

Write^{*1}: Specify the number of word devices (1 to 64) at the destination.

For **Move**, specify how many times to write.

This setting is enabled only if **Action Mode** is set to **Set**, **Move**, or **Set ON & OFF Data**.

For details, refer to "Write" on page 11-14.

*1 Advanced mode only

Properties of Goto Screen for Multi-Functions dialog box

Sets the Goto Screen command for the Multi-Command.

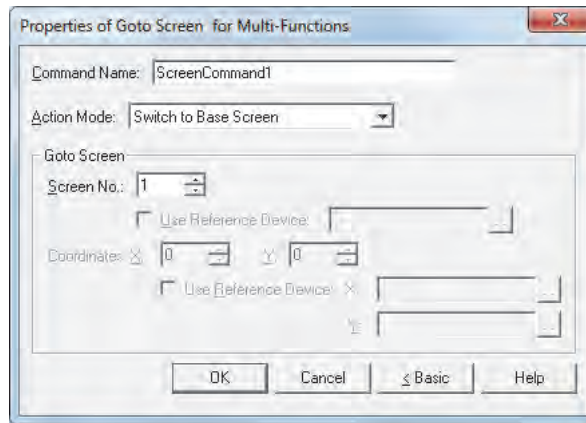

■ Command Name

Enter a name for the command. The maximum number is 20 characters.

■ Action Mode

Select the action to perform when the trigger condition is met from the following:

Back to previous Screen:	Switches to the previous screen. Returns to up to 16 earlier screens.
Switch to Base Screen:	Switches between Base Screen.
Open Popup Screen:	Opens a Popup Screen.
Close Popup Screen:	Closes a Popup Screen.
Open Device Monitor Screen:	Opens the Device Monitor Screen.
Close Device Monitor Screen:	Closes the Device Monitor Screen.
Open Ladder Monitor:	Opens the Ladder Monitor.
Close Ladder Monitor:	Closes the Ladder Monitor.
Open Password Screen:	Opens the Password Screen.
Close Password Screen:	Closes the Password Screen.
Open Adjust contrast Screen:	Opens the Adjust contrast Screen.
Close Adjust contrast Screen:	Closes the Adjust contrast Screen.
Switch to System Mode:	Switches to the Top Page in the System Mode.
Reset current screen:	Resets the current Base Screen.



- **Open Ladder Monitor** and **Close Ladder Monitor** can only operate when ladder program is selected as the programming language in control function.
- When the current Base Screen is reset using the **Reset current screen** function, the window and internal devices restart as if the Base Screens were switched.

■ Goto Screen

Screen No.: If **Action Mode** is set to **Switch to Base Screen**, specify the Base Screen number to switch to (from 1 to 3000). If **Action Mode** is set to **Open Popup Screen** or **Close Popup Screen**, specify the number of the Popup Screen to open or close (from 1 to 3015).

This setting is enabled only if **Action Mode** is set to **Switch to Base Screen**, **Open Popup Screen**, or **Close Popup Screen**.

Use Reference Device^{*1}: Select this check box and specify a device to specify the screen number using the value of the specified device.

Click to display the Device Address Settings dialog box. For the device address configuration procedure, refer to Chapter 2 "5.1 Device Address Settings" on page 2-61.

This setting is enabled only if **Action Mode** is set to **Open Popup Screen** or **Close Popup Screen**.

Coordinates X, Y: Specify the coordinates on the Base Screen for displaying a window.

X and Y specify the upper left corner of the window using the upper left corner of the screen as the origin.

This setting is enabled only if **Action Mode** is set to **Open Popup Screen**, **Open Device Monitor Screen**, **Open Password Screen**, **Open Adjust contrast Screen**, or **Open Movie File Screen**.

Use Reference Device^{*1}: Select this check box and specify a device to specify the coordinates using the value of the specified device.

Click to display the Device Address Settings dialog box. For the device address configuration procedure, refer to Chapter 2 "5.1 Device Address Settings" on page 2-61.

This setting is enabled only if **Action Mode** is set to **Open Popup Screen**.

*1 Advanced mode only

Properties of Key for Multi-Functions dialog box

Sets the Key command for the Multi-Command.

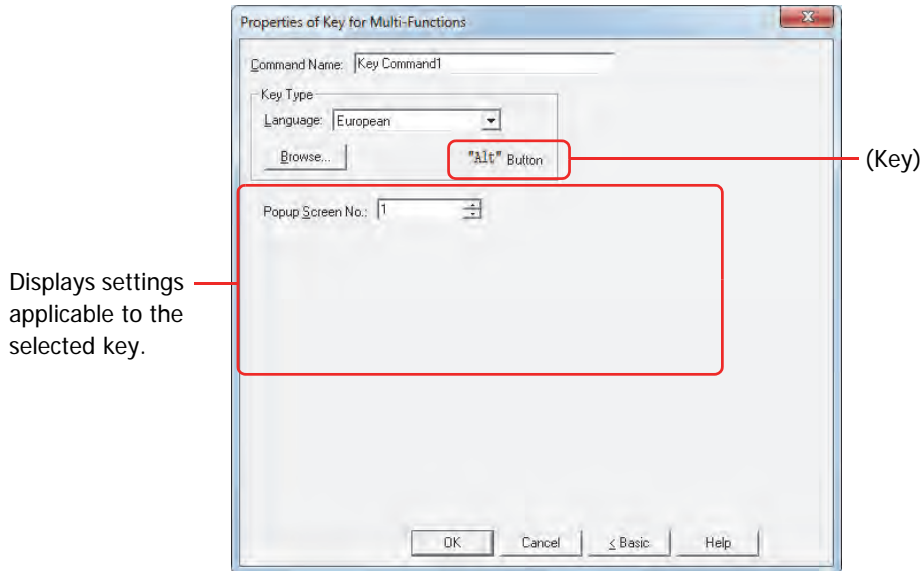

■ Command Name

Enter a name for the command. The maximum number is 20 characters.

■ Key Type

Select the function for the Key command.

Language: Switches the display of the key that is displayed when **Keypad** is selected in Key Browser. These languages are available:

Japanese, European, Central European, Baltic, Cyrillic.

Browse: Opens the Key Browser when clicked. Select a key.
For details, refer to Chapter 7 "4.5 Key Browser" on page 7-66.

(Key): Displays the name of the key selected using the Key Browser.



The function of Key command will affect on the next scan when the trigger condition is satisfied.

The settings explained below appear depending on the type of key selected.

■ Popup Screen No.

The **Alt** key switches the current Popup Screen used as a Keypad when this button is pressed.

Specify the Popup Screen number to open a Keypad for.

This setting is enabled only if **Alt** was selected using the Key Browser.

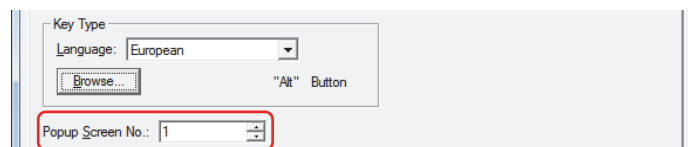

■ Scroll Size

Key Buttons **Pg. Up** and **Pg. Dwn** scroll the list up and down, respectively. Key Buttons **Fcs. Up** and **Fcs. Dwn** move the focus up and down, respectively. This settings specifies the number of pages or lines (1 to 1023 lines) to scroll or move the focus per each press of the button.

This setting is enabled only if **Pg. Up**, **Pg. Dwn**, **Fcs. Up**, and **Fcs. Dwn** are selected using the Key Browser.

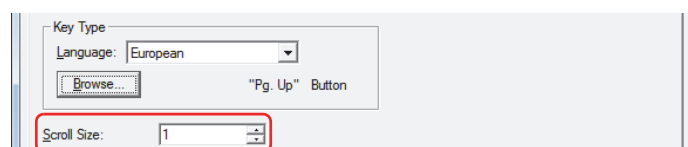

■ Transfer Setting

Key commands **Download Project** and **Upload Project** perform the data transfer function specified by their names.

These settings specify the source, data to be transferred, and destination.

This setting is enabled only if one of these keys is selected after clicking **Data Transfer** in the Key Browser.

If **Download Project** is selected.

Source: This is set to the USB flash drive on which the project file to transfer (.ZNV) was saved.

File Path: Specify the path to the project file (.ZNV) to transfer. The maximum number is 247 characters.

Example: Where "FT_DEMO_1.ZNV" is a project file saved on the root directory of a USB flash drive:

FT_DEMO_1.ZNV

If **Upload Project** is selected.

Source: Specify where to save the project uploaded from Touch. The location is the USB flash drive.

File Path: Specify the path to the folder where the uploaded project file will be saved. The maximum number is 247 characters.

Example: To save it to the folder "Uploaded_Project" on a USB flash drive:

Uploaded_Project

Properties of Script for Multi-Functions dialog box

Sets the script for the Multi-Command.

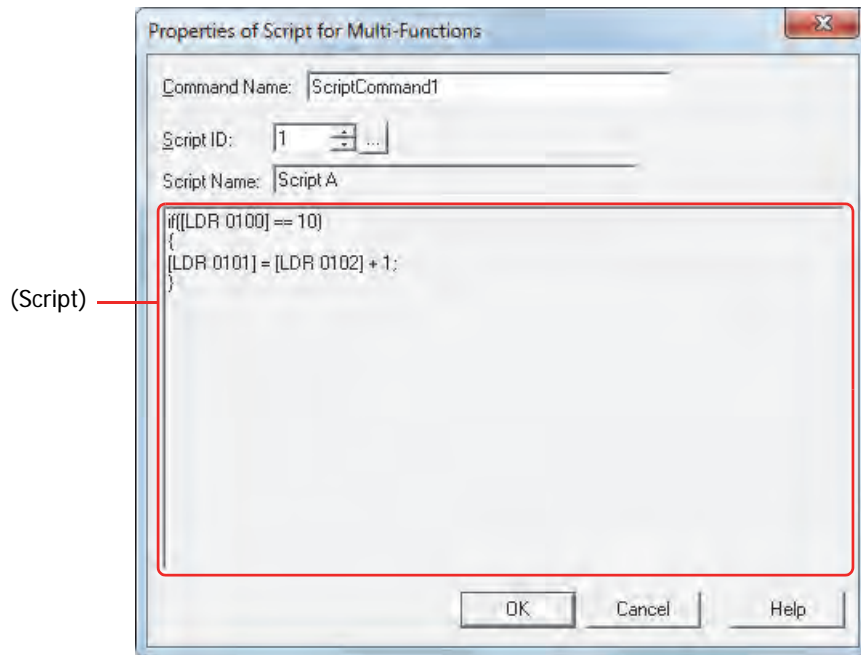

- **Command Name**

Enter a name for the command. The maximum number is 20 characters.

- **Script ID**

Specify the script ID (1 to 32,000) of the script to operate.

Script Manager will open when is clicked. Select a script from the script list.

For details, refer to Chapter 20 "2.2 Script Manager" on page 20-7.

- **Script Name**

Displays the name of the script selected in Script Manager.

- **(Script)**

Displays the contents of the script selected in Script Manager.

Once this area is double clicked, the Script Editor will open and editing can be done.

For details, refer to Chapter 20 "2.3 Script Editor" on page 20-8.

● Trigger Condition Tab

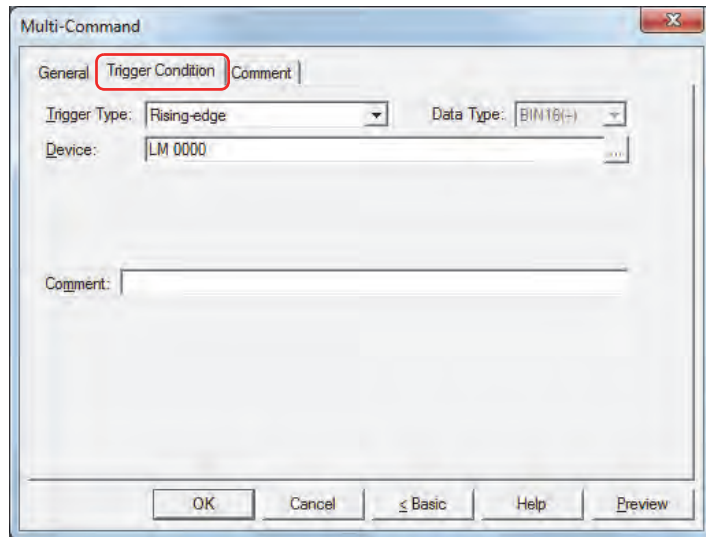

When the condition has been or is satisfied, the command is executed; when not satisfied, the command is not executed.

Example: When **Trigger Type** is **Rising-edge** and **Device** is LM0
The command is executed when LM0 changes from 0 to 1.

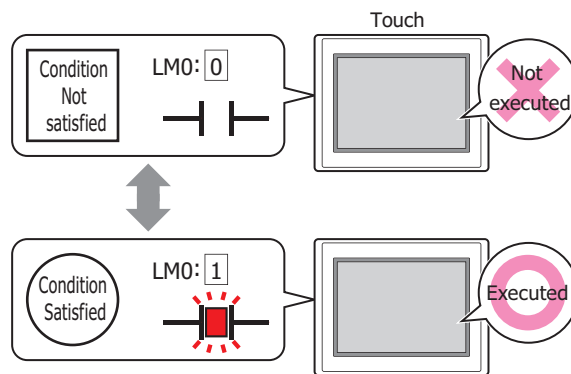

■ Trigger Type

Selects the condition to execute the command from the following.

Rising-edge: Command is executed when device changes from 0 to 1.

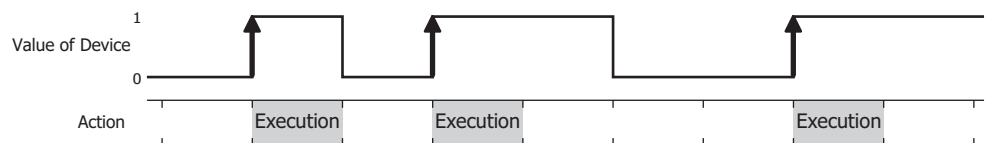

Falling-edge: Command is executed when device changes from 1 to 0.

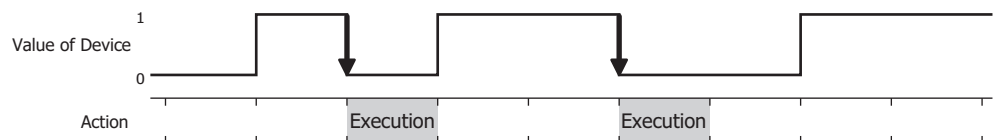

Satisfy the condition: Command is executed when condition changes from not satisfied to satisfied.

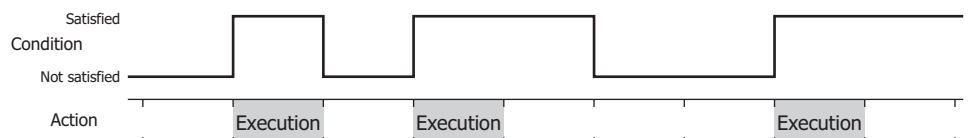

While satisfying the condition:

The command continues being executed while the condition is satisfied.

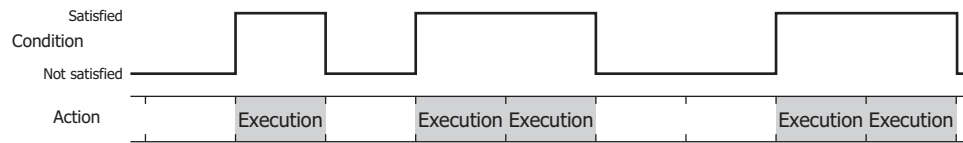

■ Data Type

Selects the data type to be handled by the condition formula.

Can only be set if **Satisfy the condition** or **While satisfying the condition** is selected as **Trigger Type**.

For details, refer to Chapter 2 "1.1 Available Data" on page 2-1.

■ Device

Specifies the bit device or bit of the word device to serve as condition.

Can only be set if **Rising-edge** or **Falling-edge** is selected as **Trigger Type**.

Click to display the Device Address Settings dialog box. For the device address configuration procedure, refer to Chapter 2 "5.1 Device Address Settings" on page 2-61.

■ Condition

Sets the condition formula.

Can only be set if **Satisfy the condition** or **While satisfying the condition** is selected as **Trigger Type**.

Click to display the Trigger Condition Settings dialog box. For the conditional expression configuration procedure, refer to Chapter 2 "5.2 Setting Conditional Expressions" on page 2-63.

■ Comment

Enter a comment about trigger conditions. The maximum number is 80 characters.

● **Comment** Tab

The **Comment** tab is used to specify the parts arranged on the editing screen, and the popup text displayed when the mouse pointer is placed close to **No.**, **Name**, or **Type** in the object list.



When there are multiple parts of the same shape on the screen, this features makes it possible to distinguish between the parts without displaying the Properties dialog box for each part, by just mousing over the part.

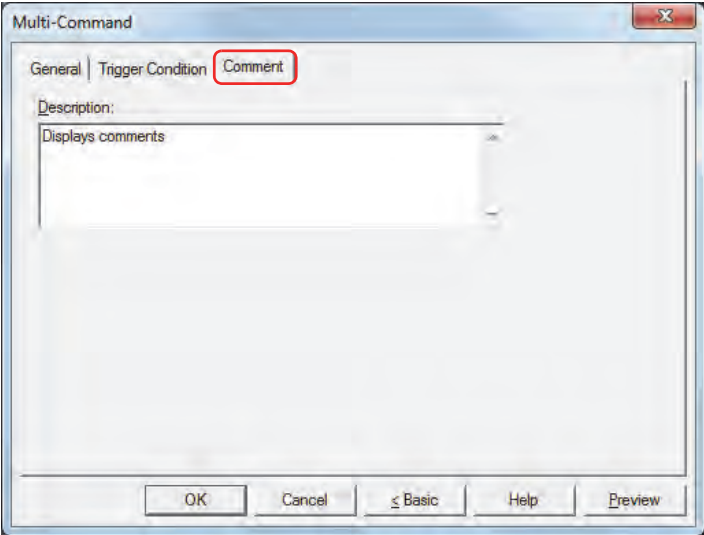

■ **Description**

Enter a comment about parts. The maximum number is 80 characters.
Example: When mousing over the Multi-Command on the editing screen



6 Timer

6.1 How the Timer is Used

Starts a countdown when the trigger condition is satisfied, and writes 1 to an internal device (HMI Timer Relay LTC) once the set time has elapsed.

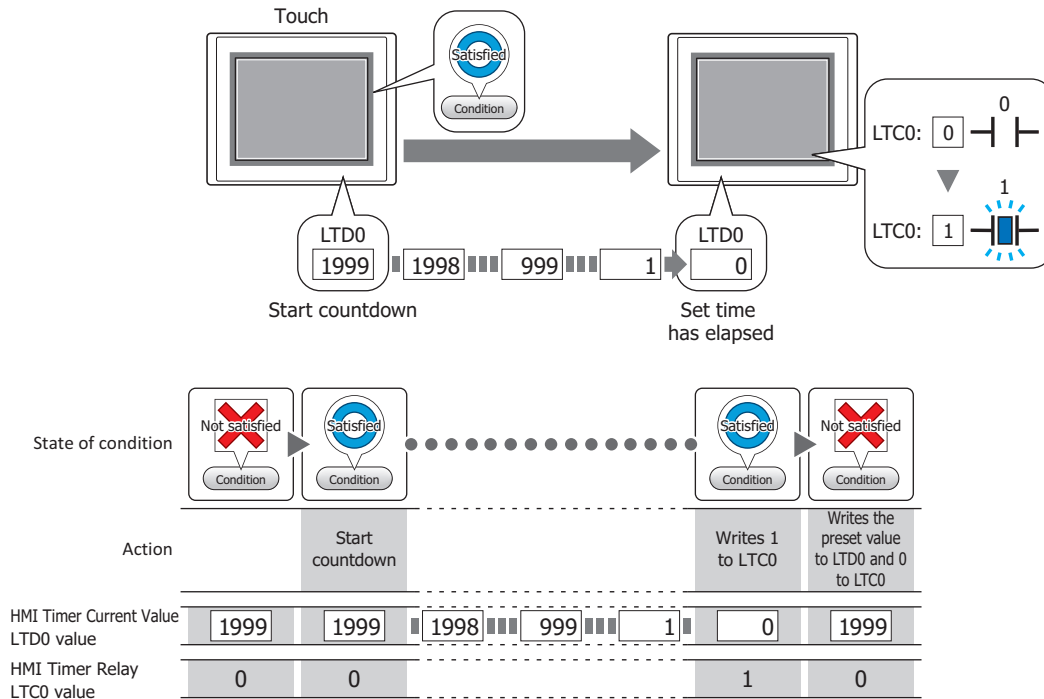

- The HMI Timer Relay LTC is an internal device (bit device) that changes to 1 once the time set for the timer has elapsed.
- The HMI Timer Current Value LTD is an internal device (word device) that stores current values for the timer.
- Once switched to the screen that the timer has been placed in, the following values will be given regardless of whether the trigger condition is satisfied or not satisfied.
 - HMI Timer Relay LTC: 0
 - HMI Timer Current Value LTD: Preset Value

6.2 Timer Configuration Procedure

This section describes the configuration procedure for Timers.

- 1 On the **Home** tab, in the **Parts** group, click **Commands**, and then click **Timer**.

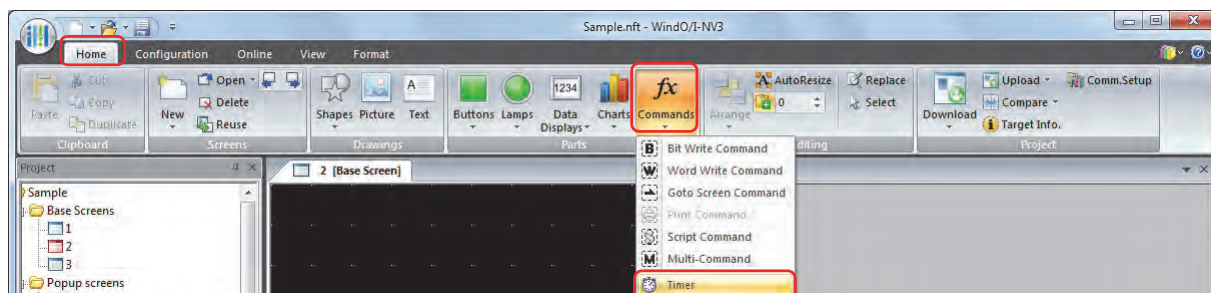

- 2 Click a point on the edit screen where you want to place the Timer.
- 3 Double-click the dropped Timer and a Properties dialog box will be displayed.
- 4 Change the settings on each tab as necessary.

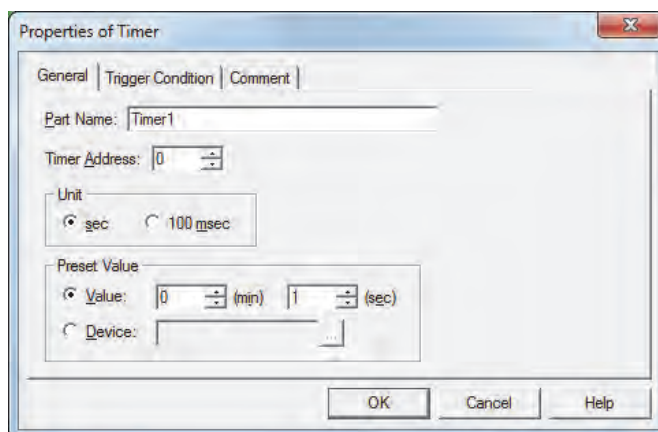

6.3 Properties of Timer Dialog Box

This section describes items and buttons in the Properties dialog box.

● General Tab

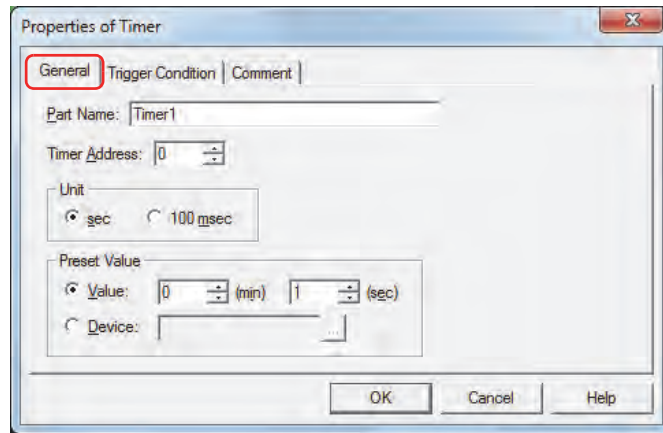

■ Part Name

Enter a name for the part. The maximum characters is 20 characters.

■ Timer Address

Specifies the HMI Timer address (0 to 31).

The device type for the HMI Timer Relay is LTC. The device type where the current value is stored is LTD.

Example: When 0 is specified for **Timer Address**

HMI Timer Relay: LTC0

HMI Timer Current Value: LTD0

■ Unit

Select the unit of time from **sec** or **100 msec**.

■ Preset Value

Select the data type to use and then enter the preset value.

The preset value is the time from when the timer starts its countdown until 1 is written to the HMI Timer Relay LTC.

Value: When selecting **sec** in **Unit**, the preset value is specified with 1 to 65535 (second units) up to a maximum of 1092 minutes 15 seconds.

When selecting **100 msec** in **Unit**, the preset value is specified with 1 to 65535 (100 milliseconds units).

Device: Uses the values of word device.

Click to display the Device Address Settings dialog box. For the device address configuration procedure, refer to Chapter 2 "5.1 Device Address Settings" on page 2-61.

● Trigger Condition Tab

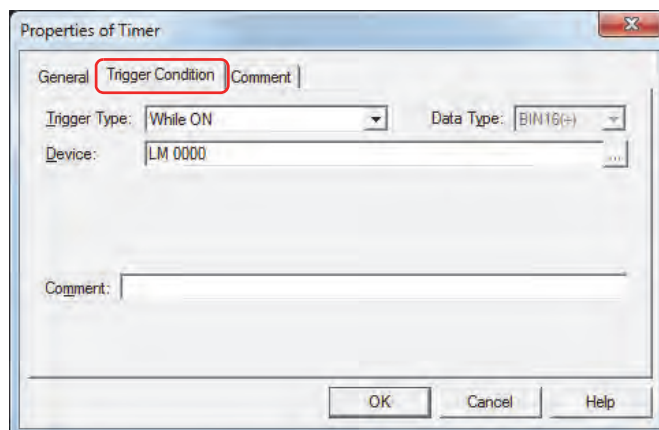

When the condition has been or is satisfied, the command is executed; when not satisfied, the command is not executed.

Example: When **Trigger Type** is **Rising-edge** and **Device** is LM0
The command is executed when LM0 changes from 0 to 1.

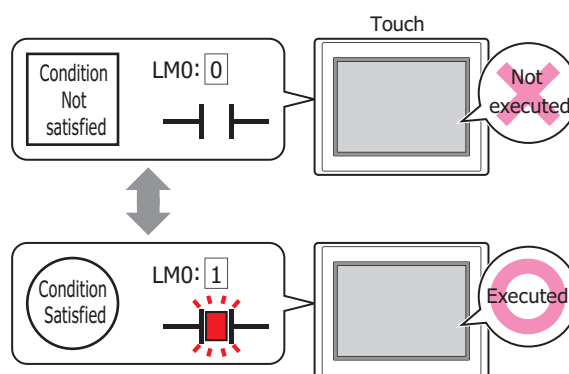

■ Trigger Type

Selects the condition to execute the command from the following.

While ON: Command is executed when device is 1.

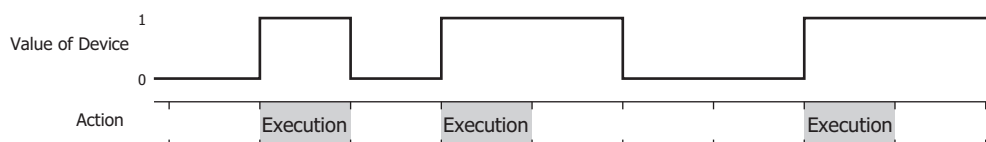

While OFF: Command is executed when device is 0.

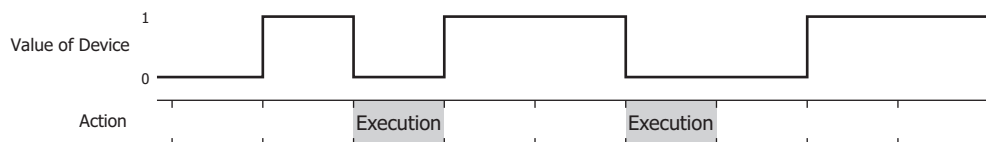

While satisfying the condition:

The command continues being executed while the condition is satisfied.

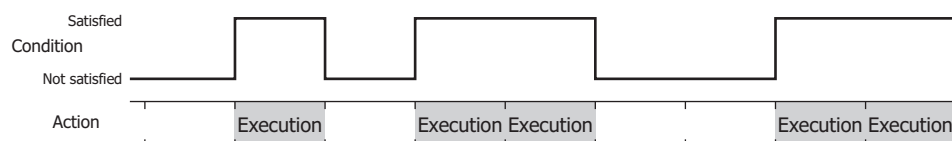

■ Data Type

Selects the data type to be handled by the condition formula.

Can only be set if **While satisfying the condition** is selected as **Trigger Type**.

For details, refer to Chapter 2 "1.1 Available Data" on page 2-1.

■ Device

Specifies the bit device or bit of the word device to serve as condition.

Can only be set if **While ON** or **While OFF** is selected as **Trigger Type**.

Click to display the Device Address Settings dialog box. For the device address configuration procedure, refer to Chapter 2 "5.1 Device Address Settings" on page 2-61.

■ Condition

Sets the condition formula.

Can only be set if **While satisfying the condition** is selected as **Trigger Type**.

Click to display the Trigger Condition Settings dialog box. For the conditional expression configuration procedure, refer to Chapter 2 "5.2 Setting Conditional Expressions" on page 2-63.

■ Comment

Enter a comment about trigger conditions. The maximum number is 80 characters.

● Comment Tab

The **Comment** tab is used to specify the parts arranged on the editing screen, and the popup text displayed when the mouse pointer is placed close to **No.**, **Name**, or **Type** in the object list.



When there are multiple parts of the same shape on the screen, this feature makes it possible to distinguish between the parts without displaying the Properties dialog box for each part, by just mousing over the part.

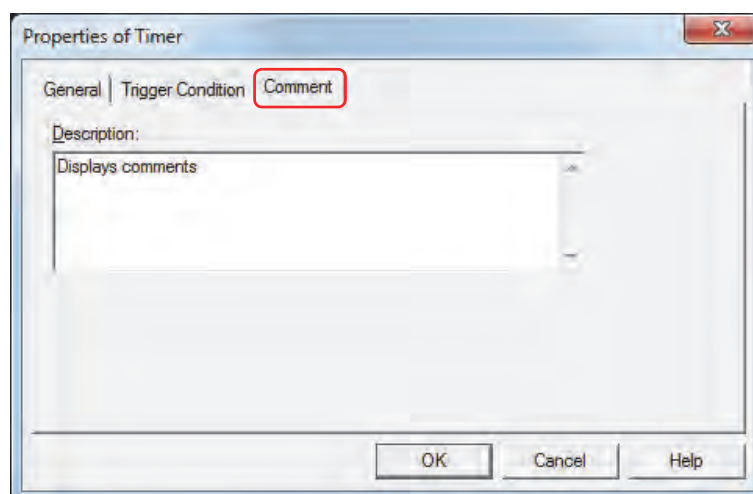

■ Description

Enter a comment about parts. The maximum number is 80 characters.

Example: When mousing over the Timer on the editing screen

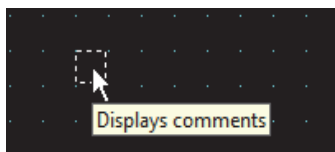

Chapter 12 Control Function

This chapter describes the actions and operations for ladder program and FBD program, basic operation for WindLDR, and functions of each instruction and FB.

The functions controlled by ladder programs or FBD programs created with WindLDR is called as control function.

1 Control Function Actions

1.1 Actions and Operations of Ladder Program and FBD Program

● Ladder Program and FBD Program Actions

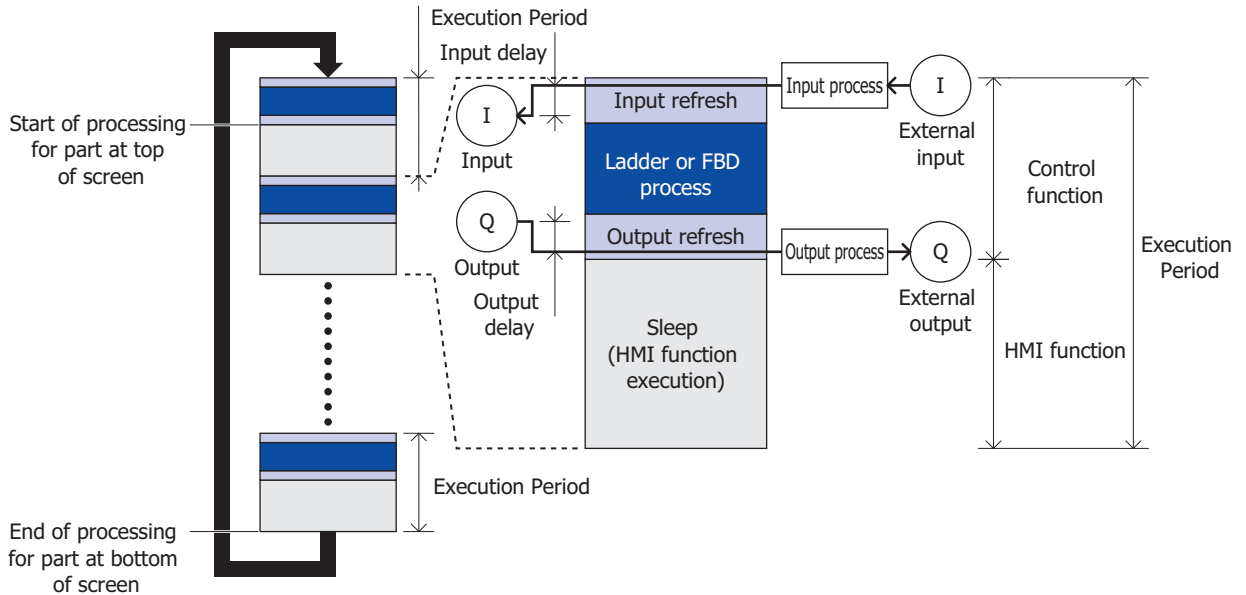

■ Input refresh

A capture process is executed at the specified input filter, and the external output is reflected in the internal device Input (I).

■ Input delay

There is a delay between an external input and the internal device Input (I). The maximum delay period is calculated by the amount of 5 microseconds, filter value and the execution period.



When an input occurs immediately after the input refresh ends, the input delay will be the longest because the processor waits for the input refresh in the next scan before reflecting the input to the input relay.

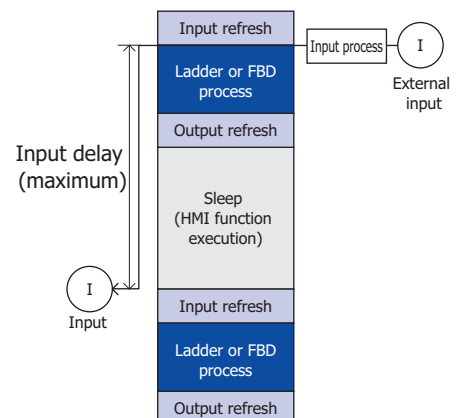

■ Ladder or FBD process

Executes the ladder program or FBD program.

■ Output refresh

Updates the relay output (Q).

Output delay

There is a delay between an external output and the internal device Output(Q). The maximum delay period is calculated by the amount of 300 milliseconds and the execution period.



When an output occurs immediately after the output refresh ends, the output delay will be the longest because the processor waits for the output refresh in the next scan before reflecting the output to the output relay.

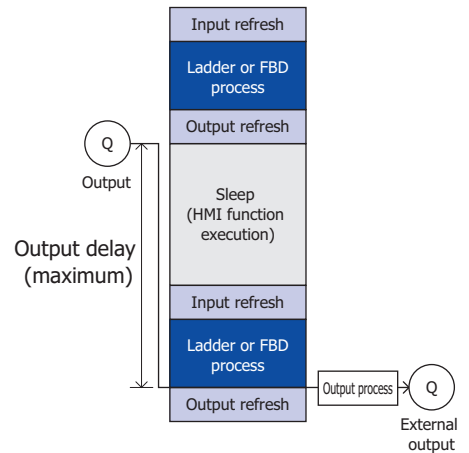

Control function

A control function refers to three processes: input refresh, ladder or FBD process, and output refresh. For details of control function settings, refer to Chapter 3 "4 Special Functions" on page 3-45, and the "SmartAXIS Ladder Programming Manual" or the "SmartAXIS FBD Programming Manual".



Only control devices can be used for control function.

Sleep

Sleep refers to the time used by the control function subtracted from the Execution Period. This is when the processor executes HMI function.

Execution Period

The Execution Period refers to one scan of the control function (input refresh + ladder or FBD process + output refresh) and HMI function (sleep).

The control function is executed once every specified execution interval.



If execution of the control function takes more than half of the time specified for the Execution Period, the processor automatically extends the Execution Period so that the control function completes within 1/2 of the Execution Period. In this instance, error number 7 will be stored in HMI Special Data Register LSD53.



There is a delay in the ladder program or FBD program. Take this delay time into consideration when specifying the Execution Period. For example, if it is necessary to capture external inputs within 100 milliseconds, set the Execution Period to 90 milliseconds. The default Execution Period is 10 milliseconds. If you don't change the default value, it will be the same as the M8123 (10 milliseconds clock) operation period. In this case, M8123 is always ON or OFF.

HMI function

Parts laid out on the screen are processed from top to bottom only when the control function is in sleep mode. Display processing pauses when execution of the next control function begins, and resumes when the function goes to sleep again.

When processing reaches the bottom of the screen, processing returns to the top of the screen.

● Executing and Stopping Ladder Programs or FBD Programs

This section describes operations to start and stop the Touch.



Make sure your safety before turning the Touch on and off. Incorrect operation may cause machine damage or accidents.

The ladder program or FBD program is executed (RUN) and stopped (STOP) by using the Touch operations, or by external input with the stop input and reset input functions.

For details on stop input settings, refer to Chapter 3 "4.2 Stop Input" on page 3-48.

For details on reset input settings, refer to Chapter 3 "4.3 Reset Input" on page 3-49.

Switching from RUN to STOP is executed by END process of the ladder program or Scan End process of the FBD program, and the following functions are stopped.

Ladder program: High-speed counter, User interrupt, Catch input, Timer interrupt

FBD program: High-speed counter, Catch input

- For outputs during STOP, keep or clear can be selected by special internal relay M8025 (Maintain Outputs While Ladder Program Operation Stopped). For details on M8025 (Maintain Outputs While Ladder Program Operation Stopped), refer to Chapter 27 "Special Internal Relay (M)" on page 27-5.
- The current values of timer instructions and timer FB are reset. For details, refer to the follows:
 - Ladder program: Timer instruction
 - ☞ Chapter 5 "Basic Instructions" - "TML (1-sec Timer)" in the "SmartAXIS Ladder Programming Manual"
 - FBD program: Timer FB
 - ☞ Chapter 8 "The timer FB" in the "SmartAXIS FBD Programming Manual"

Also, when switching from STOP to RUN, device states are cleared or kept according to **Memory Backup in Function Settings**. For details, refer to Chapter 3 "4.6 Keep and Clear Control Devices" on page 3-53.

2 Ladder Program

2.1 Basic Operation for WindLDR

This section describes basic procedures for operating WindLDR.

- Start WindLDR

On the WindO/I-NV3 **View** tab, in the **Workspace** group, click  (control function).
WindLDR starts.

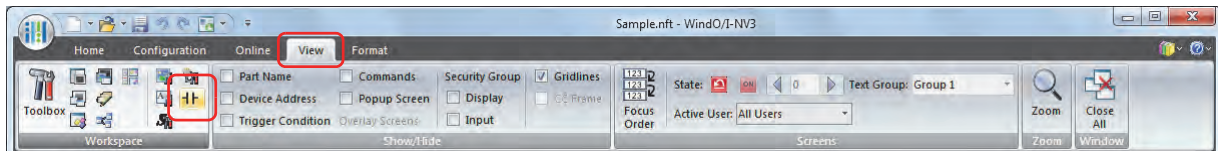

Next, create a ladder program.

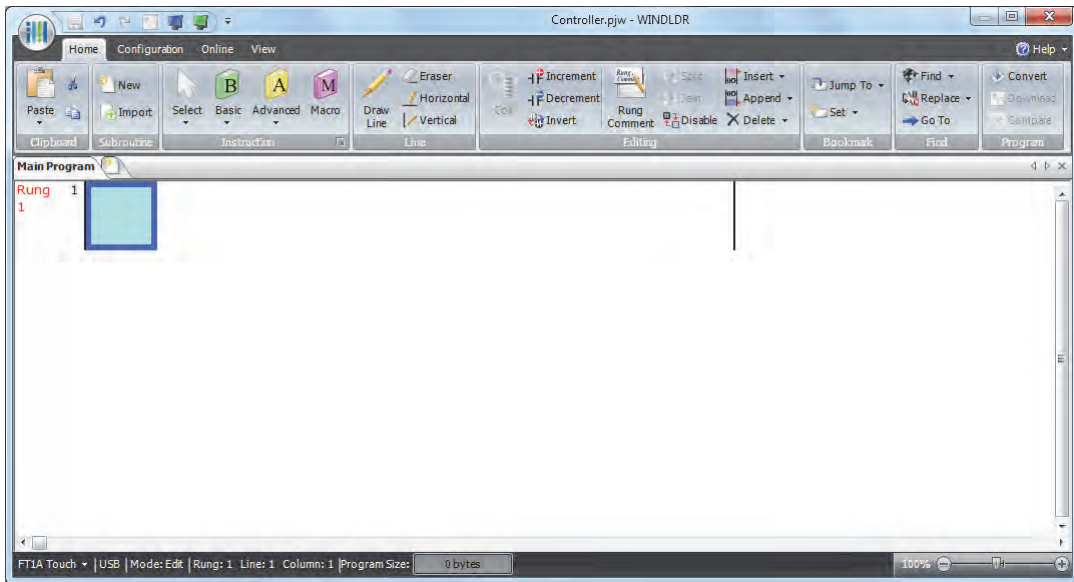

- The programming language can be changed in the PLC Selection dialog box. The PLC Selection dialog box can also be accessed using the following methods.
 - Click **PLC Type** on the status bar, and then click **PLC Selection** on the displayed drop-down list.
 - On the **Configuration** tab, in the **PLC** group, click **PLC**.
- To change the default programming language, select the programming language on the PLC Selection dialog box, and then click **Use as Default**.

● Creating Ladder Program

This section describes the procedure for creating a simple ladder program in WindLDR.



For details about basic and advanced instructions, refer to the "SmartAXIS Ladder Programming Manual".

Create a simple program using WindLDR. The sample program performs the following operation:

- When input I0 is turned on, output Q0 is turned on.
- When input I1 is turned on, output Q1 is turned on.
- When both inputs I0 and I1 are turned on, output Q2 flashes in 1-sec increments.

Rung No.	Input I0	Input I1	Output Operation
1	ON	OFF	Output Q0 is turned ON.
2	OFF	ON	Output Q1 is turned ON.
3	ON	ON	Output Q2 flashes in 1-sec increments.



One collection of a group of instructions that control output or advanced instructions is called a rung. WindLDR manages programs in rung units. Function descriptions can be configured as rung comments for individual rungs.

Inserting a NO contact of input IO

- 1 On the WindLDR **Home** tab, in the **Instruction** group, click **Basic**, and then click **A (Normally Open)**. The symbol for NO contact is displayed at the mouse pointer.

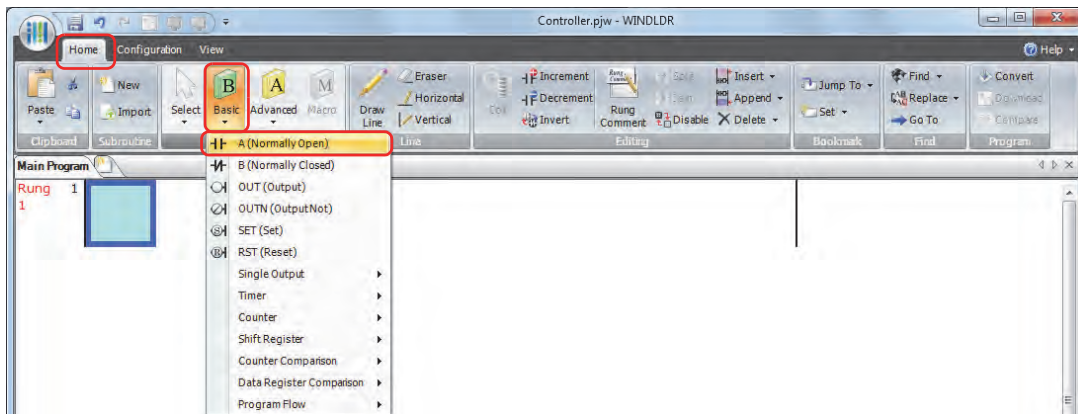

- 2 Move the mouse pointer to the first column of the first line where you want to insert a NO contact, and then click the left mouse button. The NO contact is created on the ladder line and the properties are displayed in the Property window.

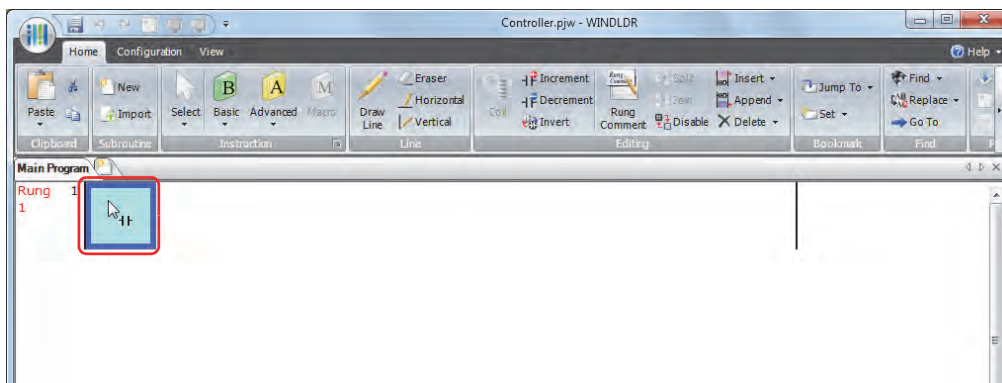

- 3 Set the device in the **Property** window. Enter "IO" for **Device** and press ENTER. A NO contact of input IO is programmed in the first column of the first ladder line.

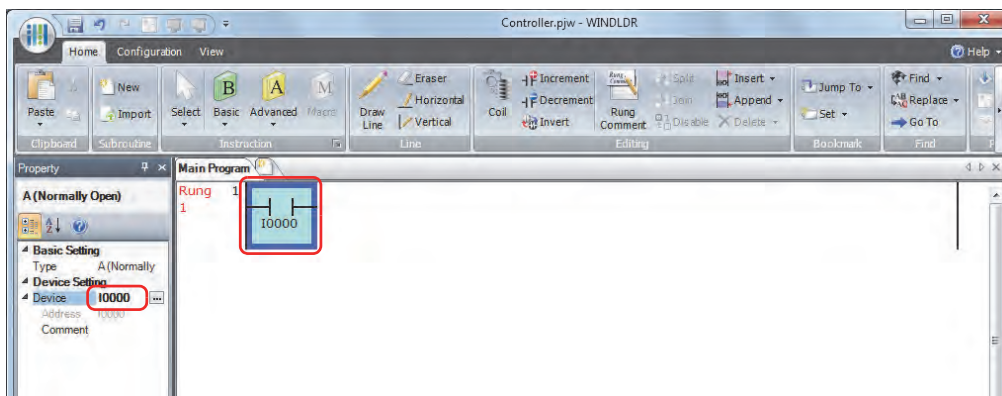

Instructions can be entered using the right-click menu or the keyboard.

If entering an instruction using the right-click menu, open the menu, click **Basic Command (B)**, and then click **A (Normally Open)**.

If entering NO contact from the keyboard, press **[A]** and then select **NO contact** from the Coil Selection dialog box and press ENTER.

For details, refer to the online help for WindLDR.

Inserting a NC contact of input I1

- 1 On the WindLDR **Home** tab, in the **Instruction** group, click **Basic**, and then click **B (Normally Closed)**. The symbol for NC contact is displayed at the mouse pointer.

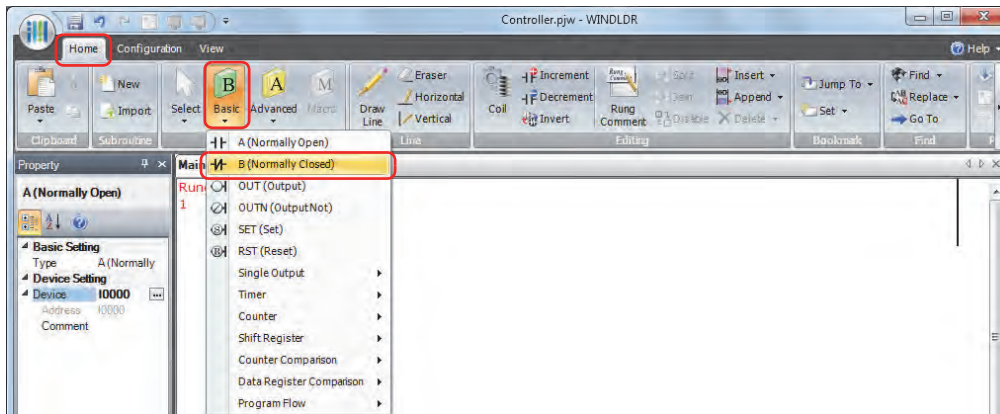

- 2 Move the mouse pointer to the second column of the first ladder line where you want to insert a NC contact, and then click the left mouse button. The NC contact is created on the ladder line and the properties are displayed in the **Property** window.

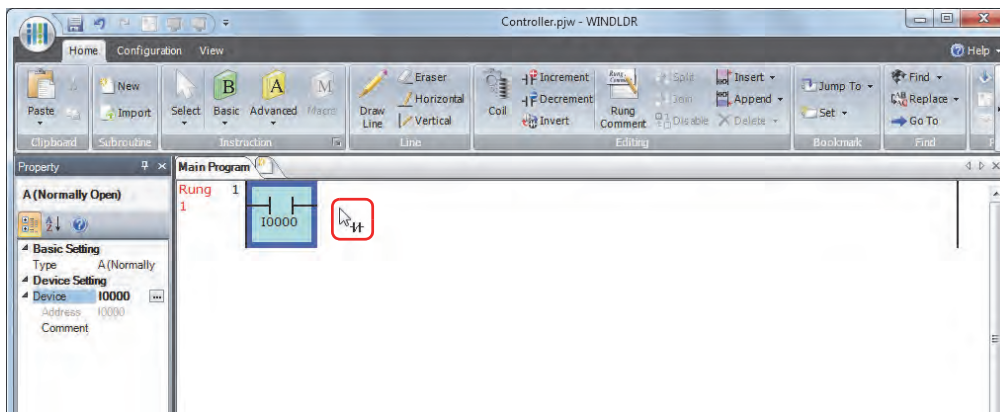

- 3 Set the device in the **Property** window. Enter "I1" for **Device** and press ENTER. A NC contact of input I1 is programmed in the first column of the first ladder line.

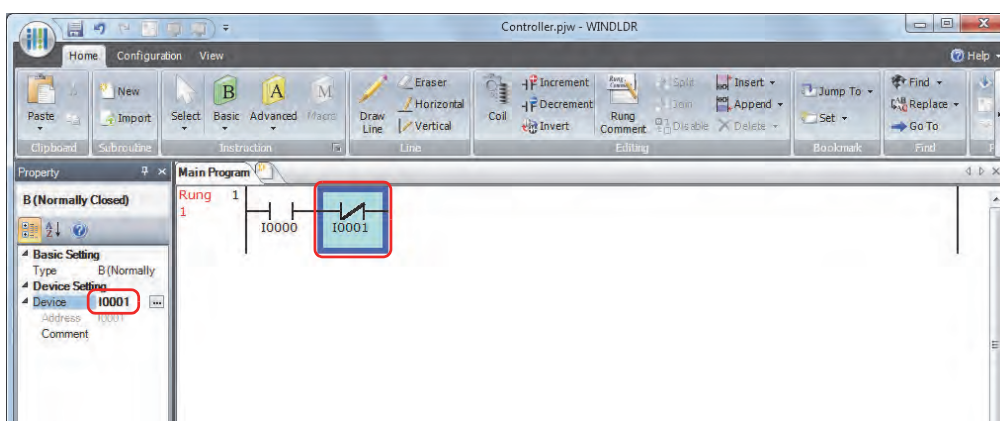

Inserting Output Q0

- 1 On the WindLDR **Home** tab, in the **Instruction** group, click **Basic**, and then click **OUT (Output)**.
The symbol for Output is displayed at the mouse pointer.

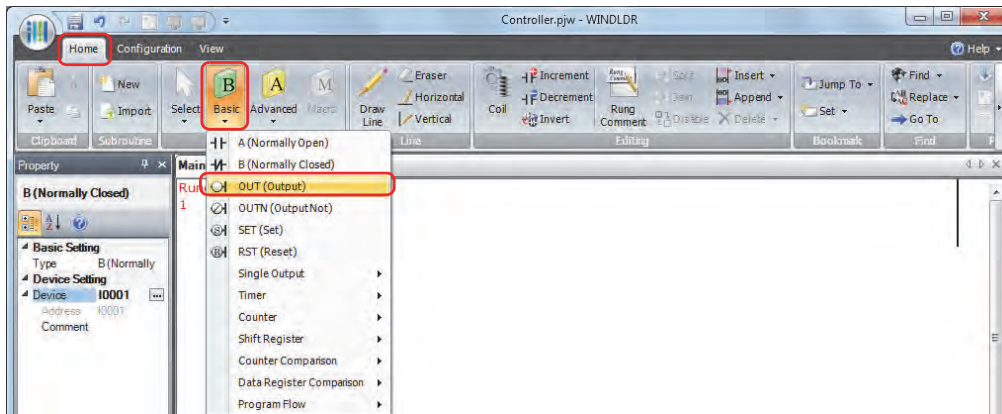

- 2 Move the mouse pointer to the third column of the first ladder line where you want to insert an output coil, and then click the left mouse button.
The output is created on the ladder line and the properties are displayed in the **Property** window.

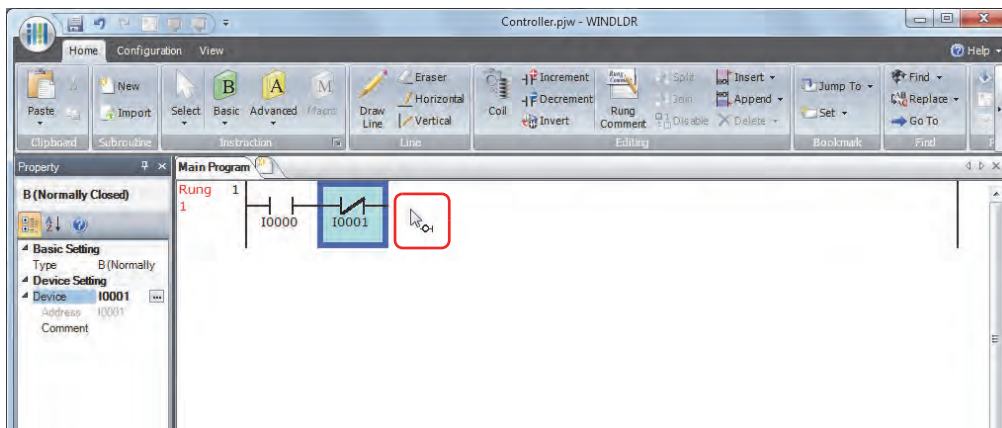

- 3 Set the device in the **Property** window.
Enter "Q0" for **Device** and press ENTER.
Output Q0 is connected to the series circuit of the NO contact for input I0 and the NC contact for input I1.

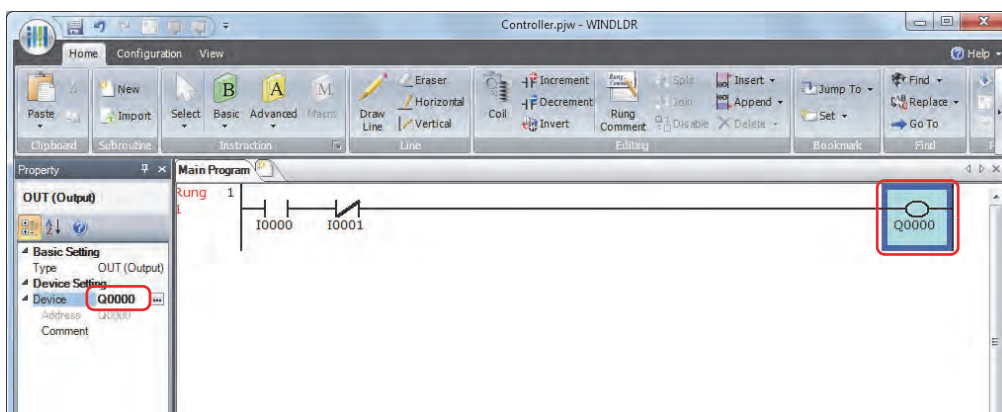

This completes programming for rung 1.

Creates Rung 2

- 1 A new rung is inserted.

To insert a rung, on the **Home** tab, in the **Editing** group, click **Append**, and then click **Append a Rung**.

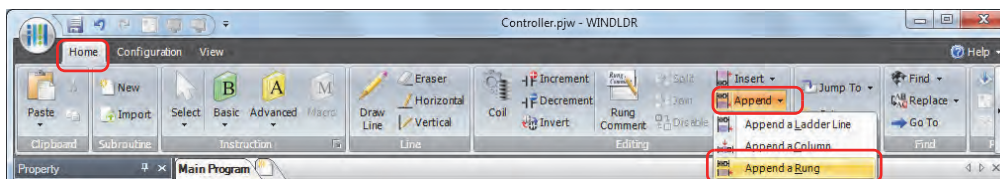

Rungs can be added using the right-click menu or the keyboard.

If inserting a rung using the right-click menu, open the menu and click **Append (N)**, and then click **Rung (R)**.

If inserting a rung from the keyboard, press ENTER.

For details, refer to the online help for WindLDR.

- 2 Enter NC contact I0 and NO contact I1, and Output Q1.

Enter NC contact I0 and NO contact I1, and Output Q1 in the same way as described from "Inserting a NO contact of input I0" on page 12-6 to "Inserting Output Q0" on page 12-8.

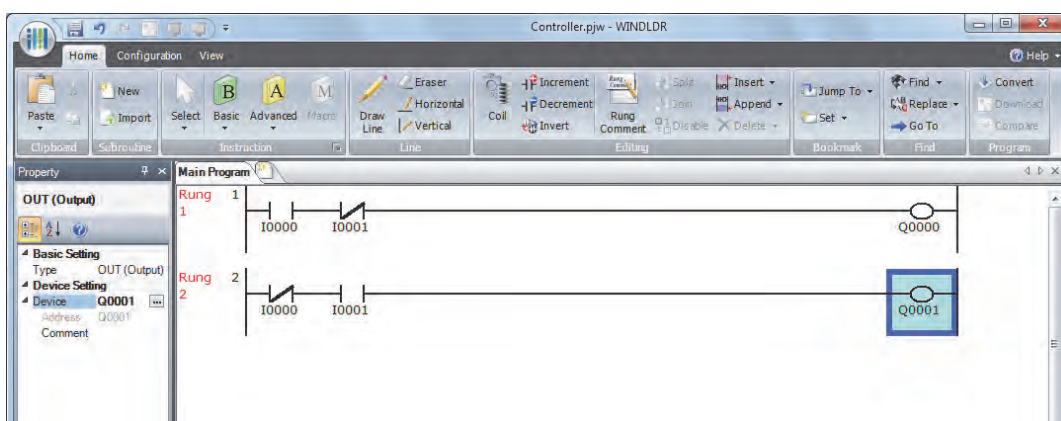

Creates Rung 3

- 1 Insert a rung and enter NO contact I0, NO contact I1, and Output M0010.

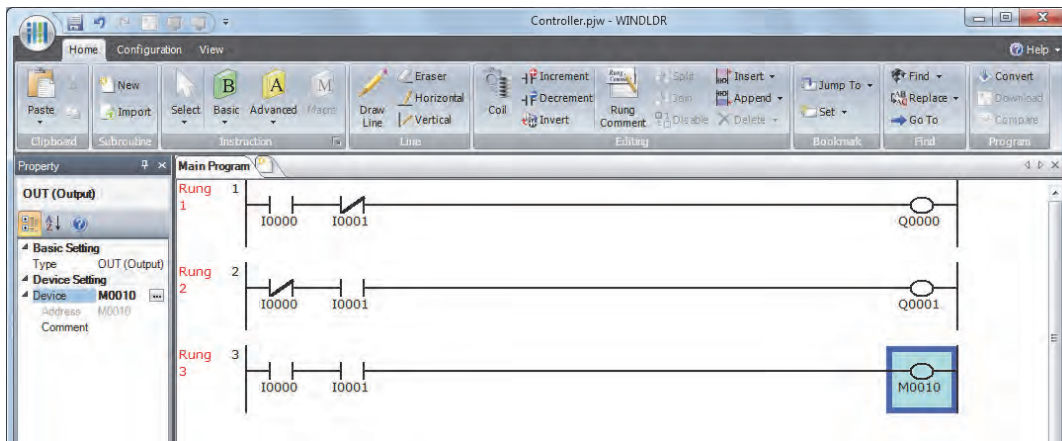

- 2 A new ladder line is inserted.

To insert a ladder line, on the **Home** tab, in the **Editing** group, click **Append**, and then click **Append a Ladder Line**.

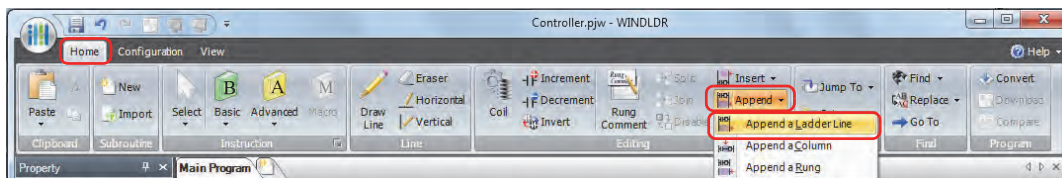

One output or computation instruction can be laid out on each ladder line. If entering multiple outputs or computation instructions within a single rung, or if setting input conditions that extend over multiple lines, insert a ladder line to the rung.

Ladder lines can be inserted using the right-click menu or the keyboard.

If inserting a rung using the right-click menu, open the menu and click **Append (N)**, and then click **Ladder Line (L)**.

If inserting a rung from the keyboard, press **⇩**.

For details, refer to the online help for WindLDR.

- 3 Enter NO contact M0010, NO contact M8121, and Output Q2.
- M8121 is a special internal relay that repeatedly toggles ON/OFF on a 1 second cycle.

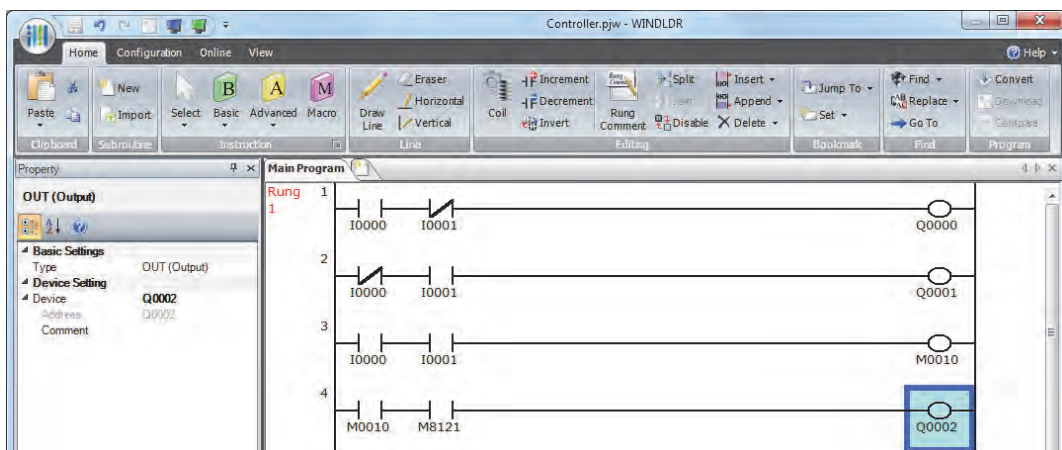

This completes programming for rung 1 to 3.

Conversion of Programs

- 1 Confirms that programs have been correctly created.

On the **Home** tab, in the **Program** group, click **Convert**.

When the instruction symbols are connected correctly, conversion is completed successfully. If any error is found, the errors are listed on the Info Window screen. Then, make corrections as necessary.

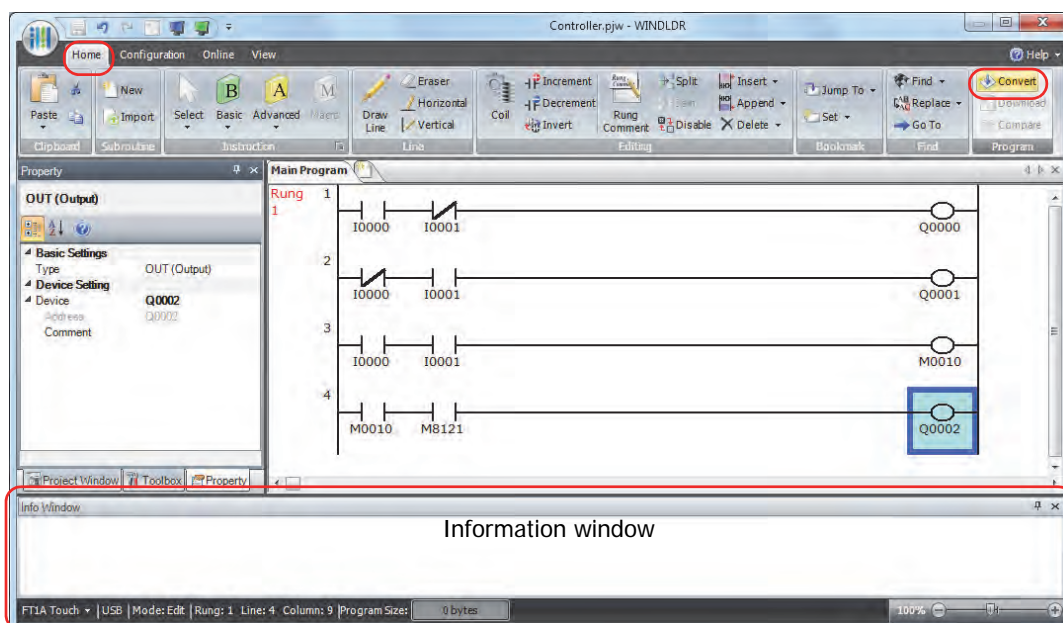

Monitor Operation

Another powerful function of WindLDR is to monitor the PLC operation on the computer. The input and output status of the sample program can be monitored in the ladder diagram.

On the WindLDR **Online** tab, in the **Monitor** group, click **Monitor**.

When both inputs I0 and I1 are on, the ladder diagram on the monitor screen looks as follows:

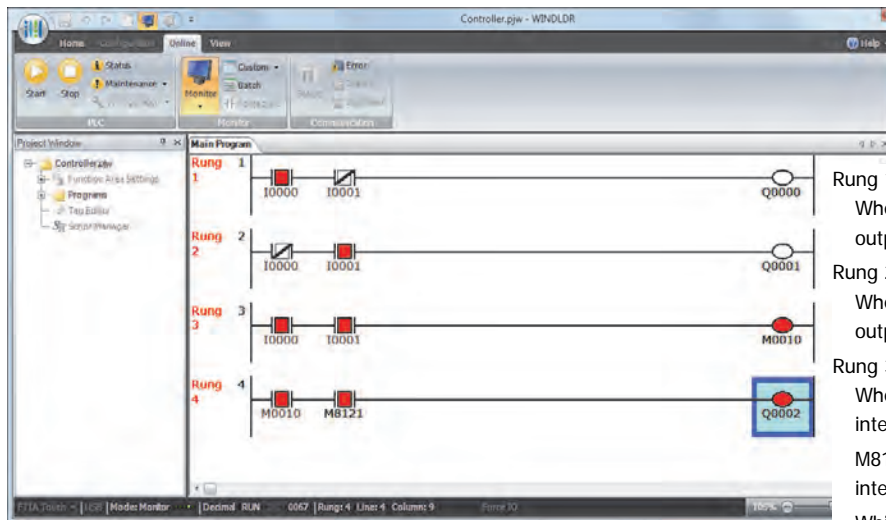

Rung 1:

When both inputs I0 and I1 are on, output Q0 is turned off.

Rung 2:

When both inputs I0 and I1 are on, output Q1 is turned off.

Rung 3:

When both inputs I0 and I1 are on, internal relay M10 is turned on.

M8121 is the 1-sec clock special internal relay.

While M10 is on, output Q2 flashes in 1-sec increments.

● Exit WindLDR

Click  in WindLDR, and then click **Exit WindLDR**.

WindLDR closes.

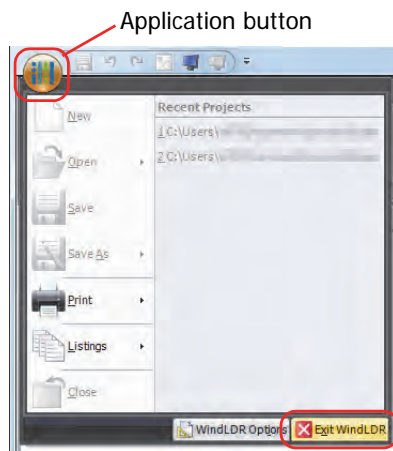

- If project data is saved during editing in WindO/I-NV3, control function are also saved.
- If you click  in WindLDR and then click **Close**, or if you close the project file while editing in WindO/I-NV3, you will exit WindLDR.

2.2 Instructions Reference

The instructions for ladder program are divided into basic instructions, which perform sequencing, and advanced instructions, which perform moves, comparisons, Boolean computations, binary arithmetic operations, bit shifts, and other operations. Some instruction words cannot be used in interrupt processes.









In an interrupt process, the processing of the main program is interrupted, using the interrupt input, timer interrupt, and high-speed counter of function settings, and a specified subroutine is executed. If a subroutine that includes instruction words that cannot be used in interrupt processes is executed, a ladder program execution error occurs.

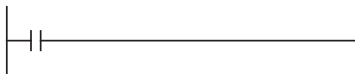
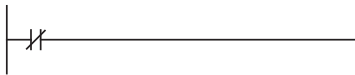
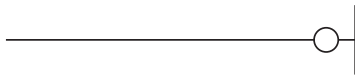
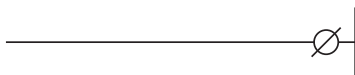

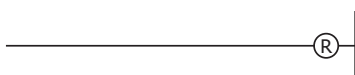
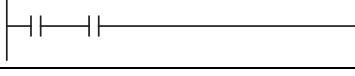
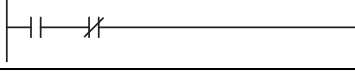
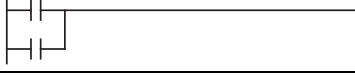
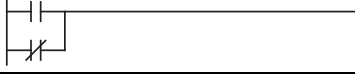

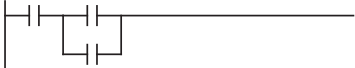
The input and operation of SmartAXIS ladder program requires specialist knowledge. To make effective use of the SmartAXIS, take the time to develop a thorough understanding of the contents and programs in this manual.

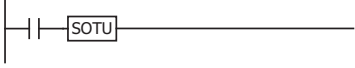
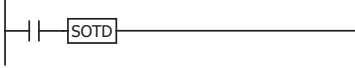
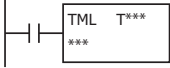
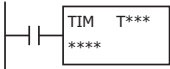
● Basic Instruction List

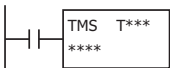
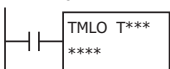
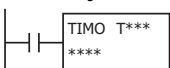
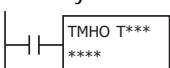
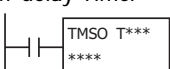
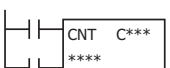
Symbol	Name and Diagram	Function	Interrupt Program Execution
LOD	Load 	The LOD instruction starts the logical operation with an NO (normally open) contact. Stores intermediate results and reads contact status	YES
LODN	Load Not 	The LODN instruction starts the logical operation with an NC (normally closed) contact. Stores intermediate results and reads contact status	YES
OUT	Output 	Outputs the result of bit logical operation	YES
OUTN	Output Not 	Outputs the inverted result of bit logical operation	YES
SET	Set 	Sets output, internal relay, data register bit or shift register	YES
RST	Reset 	Resets output, internal relay, data register bit or shift register	YES
AND	And 	Series connection of NO contact	YES
ANDN	And Not 	Series connection of NC contact	YES
OR	Or 	Parallel connection of NO contact	YES
ORN	Or Not 	Parallel connection of NC contact	YES

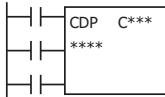
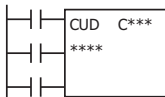
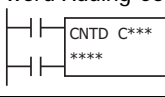
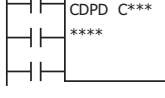
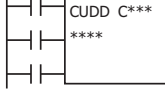
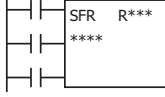
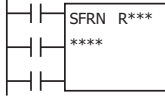
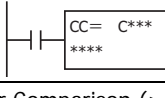
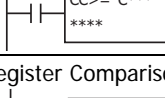
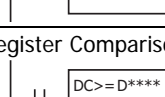
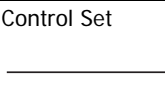
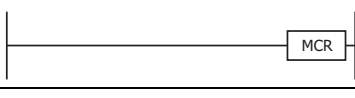
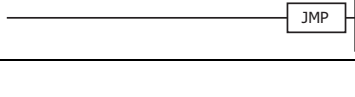
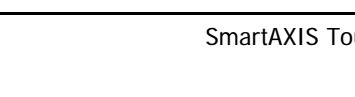
Symbol	Name and Diagram	Function	Interrupt Program Execution
AND-LOD	And Load 	Series connection of circuit blocks	YES
OR-LOD	Or Load 	Parallel connection of circuit blocks	YES
BPS	Bit Push	Saves the result of bit logical operation temporarily	YES
BRD	Bit Read	Reads the result of bit logical operation which was saved temporarily	YES
BPP	Bit Pop	Restores the result of bit logical operation which was saved temporarily	YES
SOTU	Single Output Up 	Falling-edge differentiation output	NO
SOTD	Single Output Down 	Rising-edge differentiation output	NO
TML	1-sec Timer 	1 sec On Delay timer	NO
TIM	100-ms Timer 	100 msec ON Delay timer	NO
TMH	10-ms Timer 	10 msec ON Delay timer	NO
TMS	1-ms Timer 	1 msec ON Delay timer	NO
TMLO	1-sec Off-delay Timer 	1 sec OFF Delay timer	NO
TIMO	100-ms Off-delay Timer 	100 msec OFF Delay timer	NO
TMHO	10-ms Off-delay Timer 	10 msec OFF Delay timer	NO
TMSO	1-ms Off-delay Timer 	1 msec OFF Delay timer	NO
CNT	Counter 	Adding counter	NO

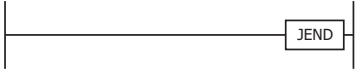

Symbol	Name and Diagram	Function	Interrupt Program Execution
CDP	Dual Pulse Reversible Counter 	Dual Pulse Reversible Counter	NO
CUD	Up/Down Selection Reversible Counter 	Up/down selection reversible counter	NO
CNTD	Double-word Adding Counter 	Double-word adding counter	NO
CDPD	Double-word Dual Pulse Reversible Counter 	Double-word dual pulse reversible counter	NO
CUDD	Double-word Up/Down Selection Reversible Counter 	Double-word up/down selection reversible counter	NO
SFR	Forward shift register 	Forward shift register	NO
SFRN	Reverse shift register 	Reverse shift register	NO
CC=	Counter Comparison (=) 	Equal to comparison of counter current value	YES
CC>=	Counter Comparison (>=) 	Greater than or equal to comparison of counter current value	YES
DC=	Data Register Comparison (=) 	Equal to comparison of data register value	YES
DC>=	Data Register Comparison (>=) 	Greater than or equal to comparison of data register value	YES
MCS	Master Control Set 	Starts a master control	YES
MCR	Master Control Reset 	Ends a master control	YES
JMP	Jump 	Jumps a designated program area	YES

Symbol	Name and Diagram	Function	Interrupt Program Execution
JEND	Jump End 	Ends a jump instruction	YES
END	End 	Ends a program	YES

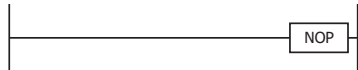
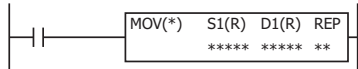
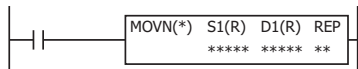
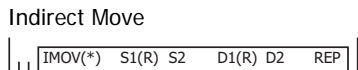
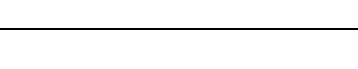
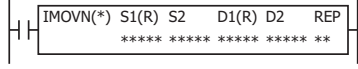
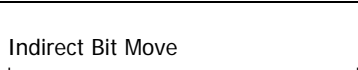
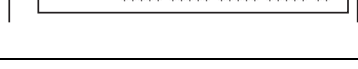
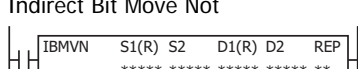
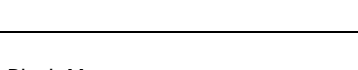
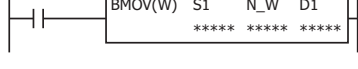
● Advanced Instruction List

Symbol	Name and Diagram	Function	Interrupt Program Execution
NOP	NOP 	No Operation	YES
MOV	Move 	When input is on, 16- or 32-bit data from device designated by S1 is moved to device designated by D1. S1 → D1	YES
MOVN	Move Not 	When input is on, 16- or 32-bit data from device designated by S1 is inverted bit by bit and moved to device designated by D1. S1 NOT → D1	YES
IMOV	Indirect Move 	When input is on, the values contained in devices designated by S1 and S2 are added to determine the source of data. The 16- or 32-bit data so determined is moved to destination, which is determined by the sum of values contained in devices designated by D1 and D2. S1 + S2 → D1 + D2	YES
IMOVN	Indirect Move Not 	When input is on, the values contained in devices designated by S1 and S2 are added to determine the source of data. The 16- or 32-bit data so determined is inverted and moved to destination, which is determined by the sum of values contained in devices designated by D1 and D2. S1 + S2 NOT → D1 + D2	YES
IBMV	Indirect Bit Move 	When input is on, the values contained in devices designated by S1 and S2 are added to determine the source of data. The 1-bit data so determined is moved to destination, which is determined by the sum of values contained in devices designated by D1 and D2. S1 + S2 → D1 + D2	YES
IBMVN	Indirect Bit Move Not 	When input is on, the values contained in devices designated by S1 and S2 are added to determine the source of data. The 1-bit data so determined is inverted and moved to destination, which is determined by the sum of values contained in devices designated by D1 and D2. S1 + S2 NOT → D1 + D2	YES
BMOV	Block Move 	When input is on, N blocks of 16-bit word data starting with device designated by S1 are moved to N blocks of destinations, starting with device designated by D1. N-W specifies the quantity of blocks to move. S1, S1+1, S1+2, ... , S1+N-1 → D1, D1+1, D1+2, ... , D1+N-1	YES
NSET	N Data Set 	When input is on, N blocks of 16- or 32-bit data in devices designated by S1, S2, S3, ... , Sn are moved to N blocks of destinations, starting with device designated by D1. S1, S2, S3, ... , Sn → D1, D2, D3, ... , Dn	YES
NRS	N Data Repeat Set 	When input is on, 16- or 32-bit data designated by S1 is set to N blocks of destinations, starting with device designated by D1. S1 → D1, D2, D3, ... , Dn-1	YES
XCHG	Exchange 	When input is on, the 16- or 32-bit data in devices designated by D1 and D2 are exchanged with each other. Word data type: D1 ↔ D2 Double-word data type: D1·D1+1 → D2, D2+1	YES

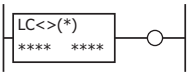
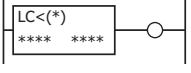
Symbol	Name and Diagram	Function	Interrupt Program Execution
TCCST	Timer/Counter Current Value Store 	When input is on, 16- or 32-bit data designated by S1 is read out and stored to the current value of device designated by D1. $S1 \rightarrow D1$	YES
CMP=	Compare Equal To 	When input is on, 16- or 32-bit data designated by source devices S1 and S2 are compared. When S1 data is equal to S2 data, destination device D1 is turned on. When the condition is not met, D1 is turned off. Data type W or I: $S1 = S2 \rightarrow D1$ on Data type D, L, or F: $S1 \cdot S1+1 = S2 \cdot S2+1 \rightarrow D1$ on	YES
CMP<>	Compare Unequal To 	When input is on, 16- or 32-bit data designated by source devices S1 and S2 are compared. When S1 data is not equal to S2 data, destination device D1 is turned on. When the condition is not met, D1 is turned off. Data type W or I: $S1 \neq S2 \rightarrow D1$ on Data type D, L, or F: $S1 \cdot S1+1 \ S2 \cdot S2+1 \rightarrow D1$ on	YES
CMP<	Compare Less Than 	When input is on, 16- or 32-bit data designated by source devices S1 and S2 are compared. When S1 data is less than S2 data, destination device D1 is turned on. When the condition is not met, D1 is turned off. Data type W or I: $S1 < S2 \rightarrow D1$ on Data type D, L, or F: $S1 \cdot S1+1 < S2 \cdot S2+1 \rightarrow D1$ on	YES
CMP>	Compare Greater Than 	When input is on, 16- or 32-bit data designated by source devices S1 and S2 are compared. When S1 data is greater than S2 data, destination device D1 is turned on. When the condition is not met, D1 is turned off. Data type W or I: $S1 > S2 \rightarrow D1$ on Data type D, L, or F: $S1 \cdot S1+1 > S2 \cdot S2+1 \rightarrow D1$ on	YES
CMP<=	Compare Less Than or Equal To 	When input is on, 16- or 32-bit data designated by source devices S1 and S2 are compared. When S1 data is less than or equal to S2 data, destination device D1 is turned on. When the condition is not met, D1 is turned off. Data type W or I: $S1 \leq S2 \rightarrow D1$ on Data type D, L, or F: $S1 \cdot S1+1 \leq S2 \cdot S2+1 \rightarrow D1$ on	YES
CMP>=	Compare Greater Than or Equal To 	When input is on, 16- or 32-bit data designated by source devices S1 and S2 are compared. When S1 data is greater than or equal to S2 data, destination device D1 is turned on. When the condition is not met, D1 is turned off. Data type W or I: $S1 \geq S2 \rightarrow D1$ on Data type D, L, or F: $S1 \cdot S1+1 \geq S2 \cdot S2+1 \rightarrow D1$ on	YES
ICMP>=	Interval Compare Greater Than or Equal To 	When input is on, the 16- or 32-bit data designated by S1, S2, and S3 are compared. When the condition is met, destination device D1 is turned on. When the condition is not met, D1 is turned off. Data type W or I: $S1 \leq S2 \leq S3 \rightarrow D1$ on Data type D, L, or F: $S1 \cdot S1+1 \leq S2 \cdot S2+1 \leq S3 \cdot S3+1 \rightarrow D1$ on	YES
LC=	Load Compare Equal To 	This instruction constantly compares 16- or 32-bit data designated by S1 and S2. When S1 data is equal to S2 data, the output to the following instructions is turned on. When the condition is not met, the output is turned off. Data type W or I: $S1 = S2$ Data type D, L, or F: $S1 \cdot S1+1 = S2 \cdot S2+1$	YES

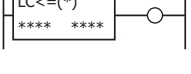
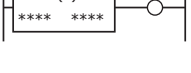
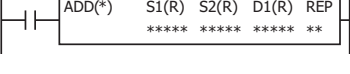
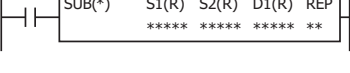
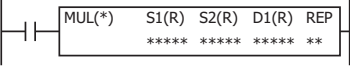
Symbol	Name and Diagram	Function	Interrupt Program Execution
LC<>	Load Compare Unequal To 	This instruction constantly compares 16- or 32- bit data designated by S1 and S2. When S1 data is equal to S2 data, the output to the following instructions is turned on. When the condition is not met, the output is turned off. Data type W or I: $S1 \neq S2$ Data type D, L, or F: $S1 \cdot S1+1 \neq S2 \cdot S2+1$	YES
LC<	Load Compare Less Than 	This instruction constantly compares 16- or 32- bit data designated by S1 and S2. When S1 data is less than S2 data, the output to the following instructions is turned on. When the condition is not met, the output is turned off. Data type W or I: $S1 < S2$ Data type D, L, or F: $S1 \cdot S1+1 < S2 \cdot S2+1$	YES
LC>	Load Compare Greater Than 	This instruction constantly compares 16- or 32- bit data designated by S1 and S2. When S1 data is greater than S2 data, the output to the following instructions is turned on. When the condition is not met, the output is turned off. Data type W or I: $S1 > S2$ Data type D, L, or F: $S1 \cdot S1+1 > S2 \cdot S2+1$	YES
LC<=	Load Compare Less Than or Equal To 	This instruction constantly compares 16- or 32- bit data designated by S1 and S2. When S1 data is less than or equal to S2 data, the output to the following instructions is turned on. When the condition is not met, the output is turned off. Data type W or I: $S1 \leq S2$ Data type D, L, or F: $S1 \cdot S1+1 \leq S2 \cdot S2+1$	YES
LC>=	Load Compare Greater Than or Equal To 	This instruction constantly compares 16- or 32- bit data designated by S1 and S2. When S1 data is greater than or equal to S2 data, the output to the following instructions is turned on. When the condition is not met, the output is turned off. Data type W or I: $S1 \geq S2$ Data type D, L, or F: $S1 \cdot S1+1 \geq S2 \cdot S2+1$	YES
ADD	Addition 	When input is on, 16- or 32-bit data designated by source devices S1 and S2 are added. The result is set to destination device D1 and carry (M8003). Data type W or I: $S1 + S2 \rightarrow D1, CY$ Data type D, L, or F: $S1 \cdot S1+1 + S2 \cdot S2+1 \rightarrow D1 \cdot D1+1, CY$	YES
SUB	Subtraction 	When input is on, 16- or 32-bit data designated by source device S2 is subtracted from 16- or 32-bit data designated by source device S1. The result is set to destination device D1 and borrow (M8003). Data type W or I: $S1 - S2 \rightarrow D1, BW$ Data type D, L, or F: $S1 \cdot S1+1 - S2 \cdot S2+1 \rightarrow D1 \cdot D1+1, BW$	YES
MUL	Multiplication 	When input is on, 16- or 32-bit data designated by source device S1 is multiplied by 16- or 32-bit data designated by source device S2. The result is set to destination device D1. When the result exceeds the valid range for data types D or L, the special internal relay M8004 (ladder program execution error) is turned on. Data type W or I: $S1 \times S2 \rightarrow D1 \cdot D1+1$ Data type D, L, or F: $S1 \cdot S1+1 \times S2 \cdot S2+1 \rightarrow D1 \cdot D1+1$	YES

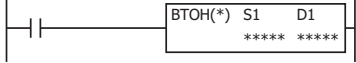
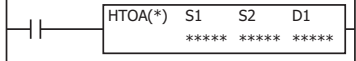
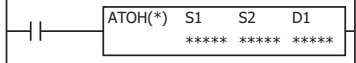
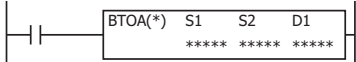
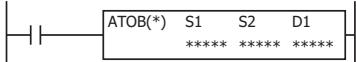
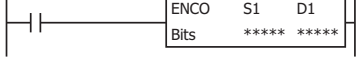
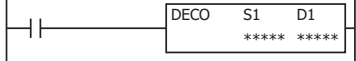
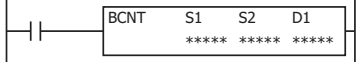

Symbol	Name and Diagram	Function	Interrupt Program Execution
DIV	<p>Division</p>	<p>When input is on, 16- or 32-bit data designated by source device S1 is divided by 16- or 32-bit data designated by source device S2. The quotient is set to 16- or 32-bit destination device D1, and the remainder is set to the next 16- or 32-bit data. Data type F does not generate a remainder.</p> <p>When S2 is 0 (dividing by 0), the special internal relay M8004 (ladder program execution error) is turned on.</p> <p>Data type W or I: $S1 \div S2 \rightarrow D1$ (quotient), $D1+1$ (remainder)</p> <p>Data type D or L: $S1 \cdot S1+1 \div S2 \cdot S2+1 \rightarrow D1 \cdot D1+1$ (quotient), $D1+2 \cdot D1+3$ (remainder)</p> <p>Data type F: $S1 \cdot S1+1 \div S2 \cdot S2+1 \rightarrow D1 \cdot D1+1$ (quotient)</p>	YES
INC	<p>Increment</p>	<p>When input is on, one is added to the 16- or 32-bit data designated by device S/D and the result is stored to the same device.</p> <p>Data type W or I: $S/D + 1 \rightarrow S/D$</p> <p>Data type D or L: $S/D \cdot S/D+1 + 1 \rightarrow S/D \cdot S/D+1$</p>	YES
DEC	<p>Decrement</p>	<p>When input is on, one is subtracted from the 16- or 32-bit data designated by device S/D and the result is stored to the same device.</p> <p>Data type W or I: $S/D - 1 \rightarrow S/D$</p> <p>Data type D or L: $S/D \cdot S/D+1 - 1 \rightarrow S/D \cdot S/D+1$</p>	YES
ROOT	<p>Root</p>	<p>When input is on, the square root of device designated by S1 is extracted and is stored to the destination designated by D1.</p> <p>The square root is calculated to two decimals, omitting the figures below the second place of decimals, and multiplied by 100.</p> <p>Data type W: $\sqrt{S1} \rightarrow D1$</p> <p>When input is on, the square root of device designated by S1·S1+1 is extracted and is stored to the destination designated by D1·D1+1.</p> <p>The square root is calculated to two decimals, omitting the figures below the second place of decimals, and multiplied by 100.</p> <p>Data type D: $\sqrt{S1 \cdot S1+1} \rightarrow D1 \cdot D1+1$</p> <p>When input is on, the square root of device designated by S1·S1+1 is extracted and is stored to the destination designated by D1·D1+1.</p> <p>Data type F: $\sqrt{S1 \cdot S1+1} \rightarrow D1 \cdot D1+1$</p>	YES
SUM	<p>Sum</p>	<p>Calculate the total of designated data, depending on the calculation option.</p> <p>ADD: When input is on, N blocks of 16- or 32-bit data starting at device designated by S1 are added and the result is stored to device designated by D1. S2 specifies the quantity of data blocks.</p> <p>XOR: When input is on, N blocks of 16-bit data starting at device designated by S1 are XORed and the result is stored to device designated by D1. S2 specifies the quantity of data blocks.</p>	YES

Symbol	Name and Diagram	Function	Interrupt Program Execution
ANDW	<p>AND Word</p>	<p>When input is on, 16- or 32-bit data designated by source devices S1 and S2 are ANDed, bit by bit. The result is set to destination device D1.</p> $S1 \cdot S2 \rightarrow D1$	YES
ORW	<p>OR Word</p>	<p>When input is on, 16- or 32-bit data designated by source devices S1 and S2 are ORed, bit by bit. The result is set to destination device D1.</p> $S1 + S2 \rightarrow D1$	YES
XORW	<p>Exclusive OR Word</p>	<p>When input is on, 16- or 32-bit data designated by source devices S1 and S2 are exclusive ORed, bit by bit. The result is set to destination device D1.</p> $S1 \oplus S2 \rightarrow D1$	YES
SFTL	<p>Shift Left</p>	<p>When input is on, N_B-bit data string starting with source device S1 is shifted to the left by the quantity of bits designated by device Bits.</p> <p>The result is set to source device S1, and the last bit status shifted out is set to a carry (special internal relay M8003). Zero or 1 designated by source device S2 is set to the LSB.</p> $CY \leftarrow S1$	YES
SFTR	<p>Shift Right</p>	<p>When input is on, N_B-bit data string starting with source device S1 is shifted to the right by the quantity of bits designated by device Bits.</p> <p>The result is set to source device S1, and the last bit status shifted out is set to a carry (special internal relay M8003). Zero or 1 designated by source device S2 is set to the MSB.</p> $S1 \rightarrow CY$	YES
BCDLS	<p>BCD Left Shift</p>	<p>When input is on, the 32-bit binary data designated by S1 is converted into 8 BCD digits, shifted to the left by the quantity of digits designated by S2, and converted back to 32-bit binary data.</p> <p>Valid values for each of S1 and S1+1 are 0 through 9999.</p> <p>The quantity of digits to shift can be 1 through 7. Zeros are set to the lowest digits as many as the digits shifted.</p>	YES
WSFT	<p>Word Shift</p>	<p>When input is on, N blocks of 16-bit word data starting with device designated by D1 are shifted up to the next 16-bit positions. At the same time, the data designated by device S1 is moved to device designated by D1. S2 specifies the quantity of blocks to move.</p>	YES
ROTL	<p>Rotate Left</p>	<p>When input is on, 16- or 32-bit data of the designated source device S1 is rotated to the left by the quantity of bits designated by device bits.</p> <p>The result is set to the source device S1, and the last bit status rotated out is set to a carry (special internal relay M8003).</p>	YES
ROTR	<p>Rotate Right</p>	<p>When input is on, 16- or 32-bit data of the designated source device S1 is rotated to the right by the quantity of bits designated by device bits.</p> <p>The result is set to the source device S1, and the last bit status rotated out is set to a carry (special internal relay M8003).</p>	YES
HTOB	<p>Hex to BCD</p>	<p>When input is on, the 16- or 32-bit data designated by S1 is converted into BCD and stored to the destination designated by device D1.</p> <p>Valid values for the source device are 0 through 9999 for the word data type, and 0 through 9999 9999 for the double-word data type.</p> $S1 \rightarrow D1$	YES



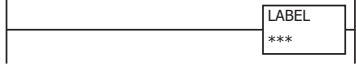
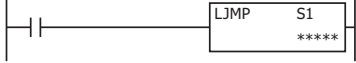
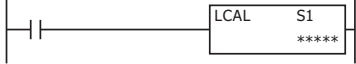
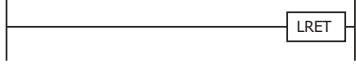
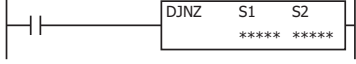

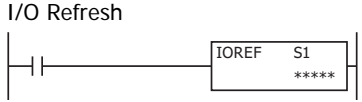
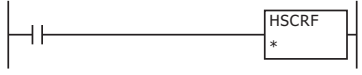
Symbol	Name and Diagram	Function	Interrupt Program Execution
BTOH	BCD to Hex 	When input is on, the BCD data designated by S1 is converted into 16- or 32-bit binary data and stored to the destination designated by device D1. Valid values for the source device are 0 through 9999 (BCD) for the word data type, and 0 through 9999 9999 (BCD) for the double-word data type. S1 → D1	YES
HTOA	Hex to ASCII 	When input is on, the 16-bit binary data designated by S1 is read from the lowest digit as many as the quantity of digits designated by S2, converted into ASCII data, and stored to the destination starting with the device designated by D1. The quantity of digits to convert can be 1 through 4. S1 → D1, D1+1, D1+2, D1+3	YES
ATOH	ASCII to Hex 	When input is on, the ASCII data designated by S1 as many as the quantity of digits designated by S2 is converted into 16-bit binary data, and stored to the destination designated by device D1. Valid values for source data to convert are 30h to 39h and 41h to 46h. The quantity of digits to convert can be 1 through 4. S1, S1+1, S1+2, S1+3 → D1	YES
BTOA	BCD to ASCII 	When input is on, the 16- or 32-bit binary data designated by S1 is converted into BCD, and converted into ASCII data. The data is read from the lowest digit as many as the quantity of digits designated by S2. The result is stored to the destination starting with the device designated by D1. The quantity of digits to convert can be 1 through 5 for the word data type, and 1 through 10 for the double-word data type. Word data type: S1 → D1, D1+1, D1+2, D1+3, D1+4 Double-word data type: S1·S1+1 → D1, D1+1, D1+2, ..., D1+9	YES
ATOB	ASCII to BCD 	When input is on, the ASCII data designated by S1 as many as the quantity of digits designated by S2 is converted into BCD, and converted into 16- or 32-bit binary data. The result is stored to the destination designated by device D1. Valid values for source data to convert are 30h through 39h. The quantity of digits to convert can be 1 through 5 for the word data type, and 1 through 10 for the double-word data type. Word data type: S1, S1+1, S1+2, S1+3, S1+4 → D1 Double-word data type: S1, S1+1, S1+2, ..., S1+9 → D1·D1+1	YES
ENCO	Encode 	When input is on, a bit which is on is sought. The search begins at S1 until the first point which is set (on) is located. The quantity of points from S1 to the first set point (offset) is stored to the destination designated by device D1. If no point is on in the searched area, 65535 is stored to D1.	YES
DECO	Decode 	When input is on, the values contained in devices designated by S1 and D1 are added to determine the destination, and the bit so determined is turned on.	YES
BCNT	Bit Count 	When input is on, bits which are on are sought in an array of consecutive bits starting at the point designated by source device S1. Source device S2 designates the quantity of bits searched. The quantity of bits which are on is stored to the destination designated by device D1.	YES

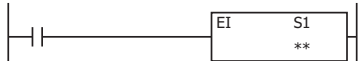
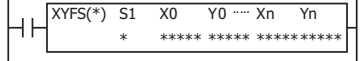
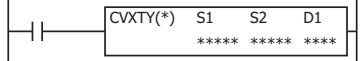
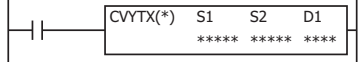
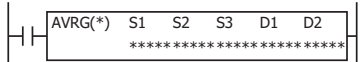
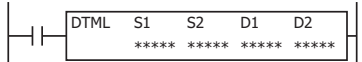
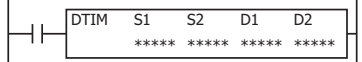
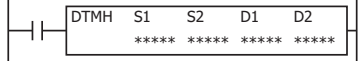
Symbol	Name and Diagram	Function	Interrupt Program Execution									
ALT	<p>Alternate Output</p>	<p>When input is turned on, output, internal relay, or shift register bit designated by D1 is turned on and remains on after the input is turned off.</p> <p>When input is turned on again, the designated output, internal relay, or shift register bit is turned off.</p> <p>The ALT instruction must be used with a SOTU or SOTD instruction, otherwise the designated output, internal relay, or shift register bit repeats to turn on and off in each scan.</p>	YES									
CVDT	<p>Convert Data Type</p>	<p>When input is on, the data type of the 16- or 32-bit data designated by S1 is converted and stored to the destination designated by device D1.</p> <p>Data types can be designated for the source and destination, separately.</p> <table border="1" style="width: 100%; border-collapse: collapse;"> <thead> <tr> <th>Data Type</th> <th>W, I</th> <th>D, L, F</th> </tr> </thead> <tbody> <tr> <td>Source</td> <td>S1</td> <td>S1·S1+1</td> </tr> <tr> <td>Destination</td> <td>D1</td> <td>D1·D1+1</td> </tr> </tbody> </table> <p>When the same data type is designated for both source and destination, the CVDT instruction has the same function as the MOV instruction.</p> <p>Unless F (float) data type is selected for both source and destination, only the integral number is moved, omitting the fraction.</p> <p>When the source data exceeds the range of destination data type, the destination stores a value closest to the source data within the destination data type.</p> <p>S1 → D1</p>	Data Type	W, I	D, L, F	Source	S1	S1·S1+1	Destination	D1	D1·D1+1	YES
Data Type	W, I	D, L, F										
Source	S1	S1·S1+1										
Destination	D1	D1·D1+1										
DTDV	<p>Data Divide</p>	<p>When input is on, the 16-bit binary data designated by S1 is divided into upper and lower bytes. The upper byte data is stored to the destination designated by device D1.</p> <p>The lower byte data is stored to the device next to D1.</p> <p>S1 → D1, D1+1</p>	YES									
DTCB	<p>Data Combine</p>	<p>When input is on, the lower-byte data is read out from 2 consecutive sources starting with device designated by S1 and combined to make 16-bit data. The lower byte data from the first source device is moved to the upper byte of the destination designated by device D1, and the lower byte data from the next source device is moved to the lower byte of the destination.</p> <p>S1, S1+1 → D1</p>	YES									
SWAP	<p>Data Swap</p>	<p>When input is on, upper and lower byte- or word-data of a word- or double-word-data designated by S1 are exchanged, and the result is stored to destination designated by D1.</p> <p>S1 → D1</p>	YES									
WEEK	<p>Weekly Timer</p>	<p>Specified day of the week and ON time and OFF time are compared with the current day/time, and the result is output</p>	NO									
YEAR	<p>Yearly Timer</p>	<p>Specified date and current date are compared and result is output</p>	NO									

Symbol	Name and Diagram	Function	Interrupt Program Execution
LABEL	<p>Label</p> 	<p>This is the label number, from 0 to 127 (all-in-one type CPU) or 0 to 255 (slim type CPU), used at the program address where the execution of program instructions begins for a program branch.</p> <p>An END instruction may be used to separate a tagged portion of the program from the main program. In this way, scan time is minimized by <i>not</i> executing the program branch unless input conditions are satisfied.</p> <p>Note: The same label number cannot be used more than once.</p>	YES
LJMP	<p>Label Jump</p> 	<p>When input is on, jump to the address with label 0 through 127 (all-in-one type CPU) or 0 to 255 (slim type CPU) designated by S1.</p> <p>When input is off, no jump takes place, and program execution proceeds with the next instruction.</p> <p>The LJMP instruction is used as an "either/or" choice between two portions of a program. Program execution does <i>not</i> return to the instruction following the LJMP instruction, after the program branch.</p>	YES
LCAL	<p>Label Call</p> 	<p>When input is on, the address with label 0 through 127 (all-in-one type CPU) or 0 to 255 (slim type CPU) designated by S1 is called. When input is off, no call takes place, and program execution proceeds with the next instruction.</p> <p>The LCALL instruction calls a subroutine, and returns to the main program after the branch is executed. A LRET instruction (see below) must be placed at the end of a program branch which is called, so that normal program execution resumes by returning to the instruction following the LCALL instruction.</p> <p>Note: The END instruction must be used to separate the main program from any subroutines called by the LCALL instruction.</p> <p>A maximum of four LCALL instructions can be nested. When more than four LCALL instructions are nested, a ladder program execution error will result, turning on special internal relay M8004.</p>	YES
LRET	<p>Label Return</p> 	<p>This instruction is placed at the end of a subroutine called by the LCALL instruction. When the subroutine is completed, normal program execution resumes by returning to the instruction following the LCALL instruction.</p> <p>The LRET must be placed at the end of the subroutine starting with a LABEL instruction. When the LRET is programmed at other places, a ladder program execution error will result, turning on special internal relay M8004.</p>	YES
DJNZ	<p>Decrement Jump Non-zero</p> 	<p>When input is on, the value stored in the data register designated by S1 is decremented by one and is checked. If the resultant value is not 0, program execution jumps to address with label 0 through 127 (all-in-one CPU) or 255 (slim CPU) designated by S2. If the decrement results in 0, no jump takes place, and program execution proceeds with the next instruction.</p>	YES

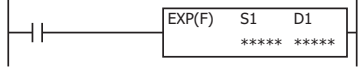
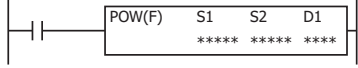
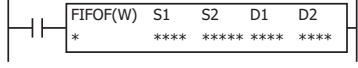
Symbol	Name and Diagram	Function	Interrupt Program Execution
IOREF	I/O Refresh 	When input is on, 1-bit I/O data designated by source device S1 is refreshed immediately regardless of the scan time. When I (input) is used as S1, the actual input status is immediately read into an internal relay starting with M300 allocated to each input available on the CPU module. When Q (output) is used as S1, the output data in the RAM is immediately written to the actual output available on the CPU module. Refresh instructions are useful when a real-time response is required in a user program which has a long scan time. The refresh instruction is most effective when using the refresh instruction at a ladder step immediately before using the data. The IOREF instruction can be used with an interrupt input or timer interrupt to refresh data.	YES
HSCRF	High-speed Counter Refresh 	When input is on, the HSCRF instruction refreshes the high-speed counter current values in special data registers in real time. The current values of four high-speed counters HSC1 through HSC4 are usually updated in every scan. The HSCRF can be used in any place in the ladder diagram where you want to read the updated high-speed counter current value.	YES
DI	Disable Interrupt 	When input is on, interrupt inputs and timer interrupt designated by source device S1 are disabled.	NO
EI	Enable Interrupt 	When input is on, interrupt inputs and timer interrupt designated by source device S1 are enabled.	NO
XYFS	XY Format Set 	When input is on, the format for XY conversion is set. The XY coordinates define the linear relationship between X and Y.	NO
CVXTY	Convert X to Y 	When input is on, the X value designated by device S2 is converted into corresponding Y value according to the linear relationship defined in the XYFS instruction. The conversion result is set to the device designated by D1.	NO
CVYTX	Convert Y to X 	When input is on, the Y value designated by device S2 is converted into corresponding X value according to the linear relationship defined in the XYFS instruction. The conversion result is set to the device designated by D1.	NO
AVRG	Average 	When input is on, sampling data designated by device S1 is processed according to sampling conditions designated by devices S2 and S3. When sampling is complete, average, maximum, and minimum values are stored to 3 consecutive devices starting with device designated by D1, then sampling completion output designated by device D2 is turned on.	NO
DTML	1-sec Dual Timer 	While input is on, destination device D1 repeats to turn on and off for a duration designated by devices S1 and S2, respectively. The time range is 0 through 65535 sec.	NO
DTIM	100-msec Dual Timer 	While input is on, destination device D1 repeats to turn on and off for a duration designated by devices S1 and S2, respectively. The time range is 0 through 6553.5 sec.	NO
DTMH	10-msec Dual Timer 	While input is on, destination device D1 repeats to turn on and off for a duration designated by devices S1 and S2, respectively. The time range is 0 through 655.35 sec.	NO

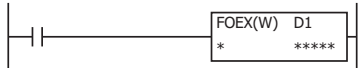
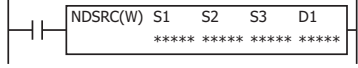
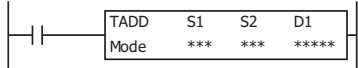
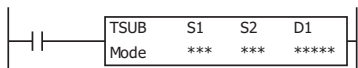
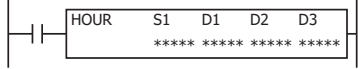
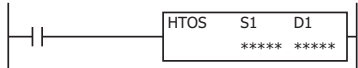
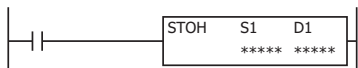
Symbol	Name and Diagram	Function	Interrupt Program Execution
DTMS	1-msec Dual Timer 	While input is on, destination device D1 repeats to turn on and off for a duration designated by devices S1 and S2, respectively. The time range is 0 through 65.535 sec.	NO
TTIM	Teaching Timer 	While input is on, the ON duration is measured in units of 100 ms and the measured value is stored to a data register designated by destination device D1. The measured time range is 0 through 6553.5 sec.	NO
RAD	Degree to Radian 	When input is on, the degree value designated by source device S1 is converted into a radian value and stored to the destination designated by device D1. $S1 \cdot S1+1 \times \pi/180 \rightarrow D1 \cdot D1+1$ rad	YES
DEG	Radian to Degree 	When input is on, the radian value designated by source device S1 is converted into a degree value and stored to the destination designated by device D1. $S1 \cdot S1+1 \text{ rad} \times 180/\pi \rightarrow D1 \cdot D1+1^\circ$	YES
SIN	Sine 	When input is on, the sine of the radian value designated by source device S1 is stored to the destination designated by device D1. $\sin S1 \cdot S1+1 \rightarrow D1 \cdot D1+1$	YES
COS	Cosine 	When input is on, the cosine of the radian value designated by source device S1 is stored to the destination designated by device D1. $\cos S1 \cdot S1+1 \rightarrow D1 \cdot D1+1$	YES
TAN	Tangent 	When input is on, the tangent of the radian value designated by source device S1 is stored to the destination designated by device D1. $\tan S1 \cdot S1+1 \rightarrow D1 \cdot D1+1$	YES
ASIN	Arc Sine 	When input is on, the arc sine of the value designated by source device S1 is stored in radians to the destination designated by device D1. $\text{asin } S1 \cdot S1+1 \rightarrow D1 \cdot D1+1$ rad If the S1·S1+1 value is not within this range, an indefinite value is stored to D1·D1+1. The S1·S1+1 value must be within the following range: $-1.0 \leq S1 \cdot S1+1 \leq 1.0$ If the S1·S1+1 value is not within this range, an indefinite value is stored to D1·D1+1.	YES
ACOS	Arc Cosine 	When input is on, the arc cosine of the value designated by source device S1 is stored in radians to the destination designated by device D1. $\text{acos } S1 \cdot S1+1 \rightarrow D1 \cdot D1+1$ rad If the S1·S1+1 value is not within this range, an indefinite value is stored to D1·D1+1. The S1·S1+1 value must be within the following range: $-1.0 \leq S1 \cdot S1+1 \leq 1.0$ If the S1·S1+1 value is not within this range, an indefinite value is stored to D1·D1+1.	YES
ATAN	Arc Tangent 	When input is on, the arc tangent of the value designated by source device S1 is stored in radians to the destination designated by device D1. $\text{atan } S1 \cdot S1+1 \rightarrow D1 \cdot D1+1$ rad	YES
LOGE	Natural Logarithm 	When input is on, the natural logarithm of the binary data designated by source device S1 is stored to the destination designated by device D1. $\log_e S1 \cdot S1+1 \rightarrow D1 \cdot D1+1$	YES
LOG10	Common Logarithm 	When input is on, the common logarithm of the binary data designated by source device S1 is stored to the destination designated by device D1. $\log_{10} S1 \cdot S1+1 \rightarrow D1 \cdot D1+1$	YES

Symbol	Name and Diagram	Function	Interrupt Program Execution
EXP	Exponent 	When input is on, e is raised to the power S1·S1+1 designated by source device S1 and is stored to the destination designated by device D1. e (base of natural logarithm) = 2.7182818 $e^{S1 \cdot S1+1} \rightarrow D1 \cdot D1+1$	YES
POW	Power 	When input is on, binary data designated by source device S1 is raised to the power S2·S2+1 designated by source device S2 and the operation result is stored to the destination designated by device D1. $S1 \cdot S1+1^{S2 \cdot S2+1} \rightarrow D1 \cdot D1+1$	YES
FIFO	FIFO Format 	When input is on, FIFO instruction initializes an FIFO data file. Each data file has unique number 0 through 9. A maximum of 10 data files can be used in a user program.	NO
FIEX	First-In Execute 	When input is on, the data stored in data registers starting with the device designated by S1 is stored to the corresponding FIFO data file.	YES
FOEX	First-Out Execute 	When input is on, the data is retrieved from the corresponding FIFO data file and stored to the data registers starting with the device designated by D1.	YES
NDSRC	N Data Search 	When input is on, a value specified by device S1 is sought. Data registers are searched, starting with the data register designated by device S2. Device S3 specifies the quantity of 1-word or 2-word blocks of data registers to search, depending on the data type. The offset of the data register where a match first occurred is stored in data register designated by device D1. The quantity of times the value was matched is stored in the next data register. When the search results in no match, 65535 is stored in device D1 and 0 is stored in device D+1.	NO
TADD	Time Addition 	When input is on, time data designated by source device S2 are added to date/time data designated by source device S1, depending on the selected mode. The result is stored to destination device D1 and carry (M8003). $S1 + S2 \rightarrow D1, CY$	YES
TSUB	Time Subtraction 	When input is on, time data designated by source device S2 are subtracted from date/time data designated by source device S1, depending on the selected mode. The result is stored to destination device D1 and borrow (M8003). $S1 - S2 \rightarrow D1, CY$	YES
HOUR	Hour 	While input is on, the ON duration is measured. The measured time value (hour, minute, and second) is stored to 3 consecutive data registers designated by destination device D1 and compared with the preset value designated by source device S1. When the D1 value reaches the S1 value, an output or internal relay designated by destination device D2 is turned on. Two data registers starting with destination device D3 are reserved for system work area. $S1 \leftrightarrow D1 \rightarrow D2$	NO
HTOS	HMS to Sec 	When input is on, time data in hours, minutes, and seconds designated by source device S1 is converted into seconds. The result is stored to destination device D1. Hours, minutes, seconds → Seconds	YES
STOH	Sec to HMS 	When input is on, time data in seconds designated by source device S1 is converted into hours, minutes, and seconds. The result is stored to destination device D1. Seconds → Hours, minutes, seconds	YES
SCRPT	Script 	Calls and executes a script from the ladder program.	YES
PID	PID 	Performs PID control.	NO

● Available Data

The available data types for each command word are as follows.



In WindLDR data types are displayed as follows: BIN16(+) as W (word), BIN16(+/-) as I (integer), BIN32(+) as D (double word), BIN32(+/-) as L (long), and float32 as F (float).

Group		Data Type				
		W	I	D	L	F
		Word	Integer	Double word	Long	Float
NOP	NOP	NO	NO	NO	NO	NO
Move	MOV	YES	YES	YES	YES	YES
	MOVN	YES	YES	YES	YES	NO
	IMOV	YES	NO	YES	NO	YES
	IMOVN	YES	NO	YES	NO	NO
	IBMV(N)	YES	NO	NO	NO	NO
	BMOV	YES	NO	NO	NO	NO
	NSET	YES	YES	YES	YES	YES
	NRS	YES	YES	YES	YES	YES
	XCHG	YES	NO	YES	NO	NO
	TCCST	YES	NO	YES	NO	NO
Data Comparison	CMP=	YES	YES	YES	YES	YES
	CMP<>	YES	YES	YES	YES	YES
	CMP<	YES	YES	YES	YES	YES
	CMP>	YES	YES	YES	YES	YES
	CMP<=	YES	YES	YES	YES	YES
	CMP>=	YES	YES	YES	YES	YES
	ICMP>=	YES	YES	YES	YES	YES
	LC=	YES	YES	YES	YES	YES
	LC<>	YES	YES	YES	YES	YES
	LC<	YES	YES	YES	YES	YES
	LC>	YES	YES	YES	YES	YES
	LC<=	YES	YES	YES	YES	YES
LC>=	YES	YES	YES	YES	YES	
Binary Arithmetic	ADD	YES	YES	YES	YES	YES
	SUB	YES	YES	YES	YES	YES
	MUL	YES	YES	YES	YES	YES
	DIV	YES	YES	YES	YES	YES
	INC	YES	YES	YES	YES	NO
	DEC	YES	YES	YES	YES	NO
	ROOT	YES	NO	YES	NO	YES
	SUM(ADD)	YES	YES	YES	YES	YES
	SUM(XOR)	YES	NO	NO	NO	NO
Boolean Computation	ANDW	YES	NO	YES	NO	NO
	ORW	YES	NO	YES	NO	NO
	XORW	YES	NO	YES	NO	NO

Group		Data Type				
		W	I	D	L	F
		Word	Integer	Double word	Long	Float
Shift and Rotate	SFTL	NO	NO	NO	NO	NO
	SFTR	NO	NO	NO	NO	NO
	BCDLS	NO	NO	YES	NO	NO
	WSFT	YES	NO	NO	NO	NO
	ROTL	YES	NO	YES	NO	NO
	ROTR	YES	NO	YES	NO	NO
Data Conversion	HTOB	YES	NO	YES	NO	NO
	BTOH	YES	NO	YES	NO	NO
	HTOA	YES	NO	NO	NO	NO
	ATOH	YES	NO	NO	NO	NO
	BTOA	YES	NO	YES	NO	NO
	ATOB	YES	NO	YES	NO	NO
	ENCO	NO	NO	NO	NO	NO
	DECO	NO	NO	NO	NO	NO
	BCNT	NO	NO	NO	NO	NO
	ALT	NO	NO	NO	NO	NO
	CVDT	YES	YES	YES	YES	YES
	DTDV	YES	NO	NO	NO	NO
	DTCB	YES	NO	NO	NO	NO
	SWAP	YES	NO	YES	NO	NO
Week Programmer	WEEK	NO	NO	NO	NO	NO
	YEAR	NO	NO	NO	NO	NO
Program Branching	LABEL	NO	NO	NO	NO	NO
	LJMP	NO	NO	NO	NO	NO
	LCAL	NO	NO	NO	NO	NO
	LRET	NO	NO	NO	NO	NO
	DJNZ	NO	NO	NO	NO	NO
I/O Refresh	IOREF	NO	NO	NO	NO	NO
	HSCRF	NO	NO	NO	NO	NO
Enable/Disable Interrupt	DI	NO	NO	NO	NO	NO
	EI	NO	NO	NO	NO	NO
Coordinate Conversion	XYFS	YES	YES	NO	NO	NO
	CVXTY	YES	YES	NO	NO	NO
	CVYTX	YES	YES	NO	NO	NO
Average	AVRG	YES	YES	YES	YES	YES
Dual / Teaching Timer	DTML	NO	NO	NO	NO	NO
	DTIM	NO	NO	NO	NO	NO
	DTMH	NO	NO	NO	NO	NO
	DTMS	NO	NO	NO	NO	NO
	TTIM	NO	NO	NO	NO	NO

Group		Data Type				
		W	I	D	L	F
		Word	Integer	Double word	Long	Float
Trigonometric Function	RAD	NO	NO	NO	NO	YES
	DEG	NO	NO	NO	NO	YES
	SIN	NO	NO	NO	NO	YES
	COS	NO	NO	NO	NO	YES
	TAN	NO	NO	NO	NO	YES
	ASIN	NO	NO	NO	NO	YES
	ACOS	NO	NO	NO	NO	YES
	ATAN	NO	NO	NO	NO	YES
Logarithm / Power	LOGE	NO	NO	NO	NO	YES
	LOG10	NO	NO	NO	NO	YES
	EXP	NO	NO	NO	NO	YES
	POW	NO	NO	NO	NO	YES
File Data Processing	FIFO	YES	NO	NO	NO	NO
	FIEX	YES	NO	NO	NO	NO
	FOEX	YES	NO	NO	NO	NO
	NDSRC	YES	YES	YES	YES	YES
Clock	TADD	NO	NO	NO	NO	NO
	TSUB	NO	NO	NO	NO	NO
	HOUR	NO	NO	NO	NO	NO
	HTOS	NO	NO	NO	NO	NO
	STOH	NO	NO	NO	NO	NO
Script	SCRPT	YES	YES	YES	YES	YES
PID	PID	NO	NO	NO	NO	NO

3 FBD Program

3.1 Basic Operation for WindLDR

This section describes basic procedures for operating WindLDR.

● Start WindLDR

- 1 On the WindO/I-NV3 **View** tab, in the **Workspace** group, click  (control function). WindLDR starts.

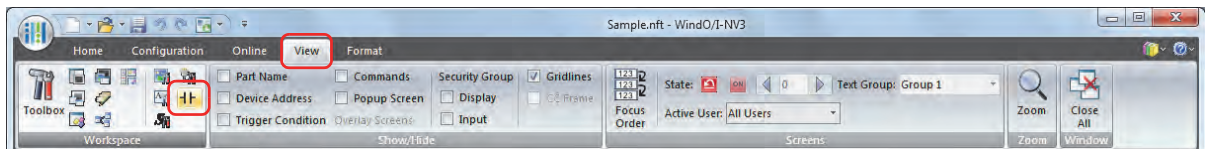

- 2 If the ladder program editing screen is displayed, click **FT1A Touch** on the status bar, and then click **PLC Selection** on the displayed drop-down list. The PLC Selection dialog box is displayed.



The PLC Selection dialog box can also be displayed by clicking **PLC Type** in the **PLC** group on the **Configuration** tab.

- 3 Select **FBD**, and then click **OK**.

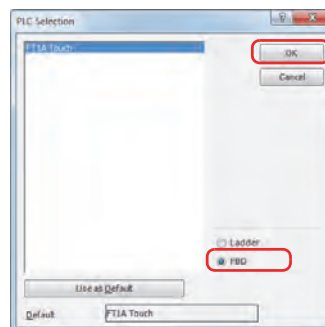

To change the default programming language, select the programming language, and then click **Use as Default**.

Next, create a FBD program.

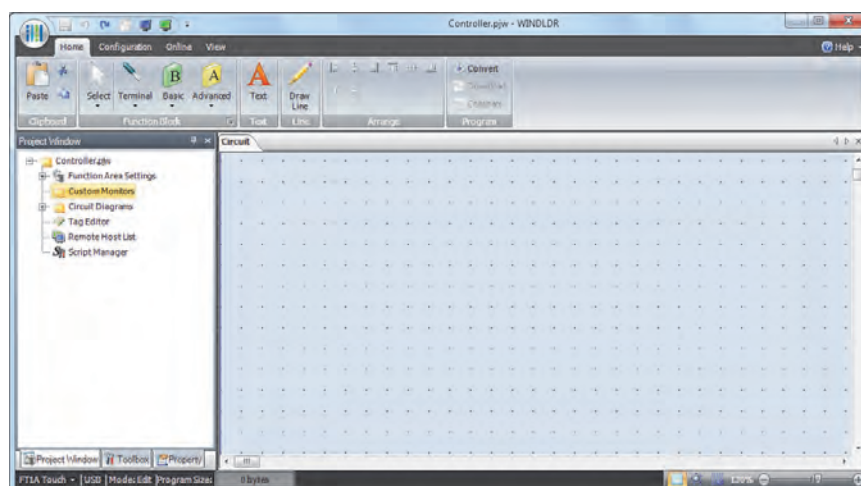

● Creating FBD Program

This section describes the procedure for creating a FBD program in WindLDR.



For details about FB, refer to the "SmartAXIS FBD Programming Manual".

Create a sample program using WindLDR that performs the following operation:

- When input I0 and input I1 are both on, output Q0 turns on.
- When either input I1 or input I2 is on, output Q1 repeatedly turns on and off in a one second cycle.

Circuit block	Input I0	Input I1	Input I2	Action
Q0	ON	ON	–	Turn output Q0 on
Q1	–	OFF	ON	Repeatedly turn output Q2 on and off in a one second cycle
	–	ON	OFF	



The output FB and all the FBs connected on the left side of that output FB's input connectors are called the circuit block. The output value of the output FB is the execution result for a single circuit block.

Insert input I0

- 1 On the WindLDR **Home** tab, in the **Function Block** group, click **Terminal**, and then click **I (Digital Input)**.

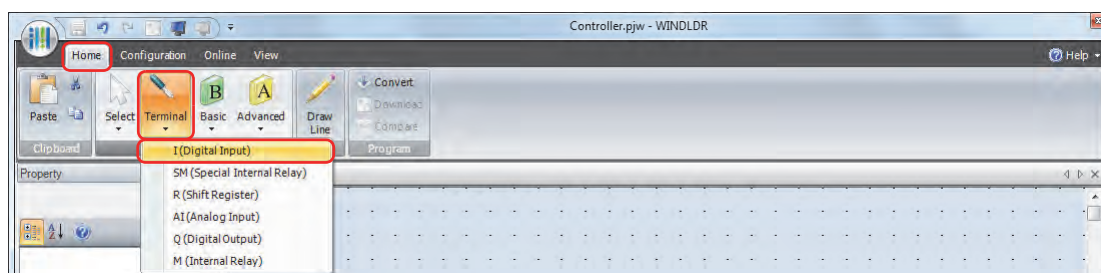

- 2 Move the mouse pointer to the FBD editor, and then click the mouse button.
Input I0 is inserted at the position of the mouse pointer.

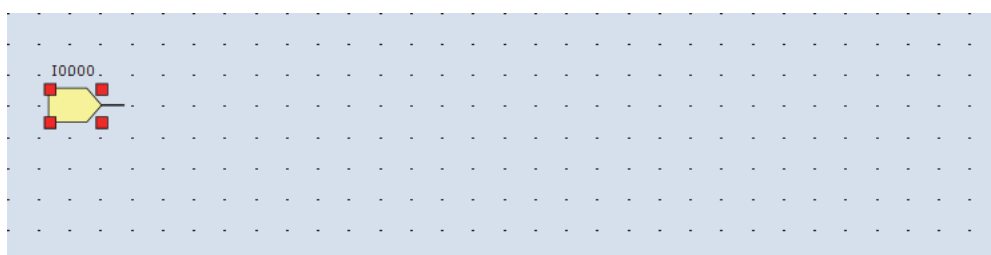

Insert the AND (logical AND) FB

- 1 On the WindLDR **Home** tab, in the **Function Block** group, click **Basic**, and then click **AND (Logical AND)**.

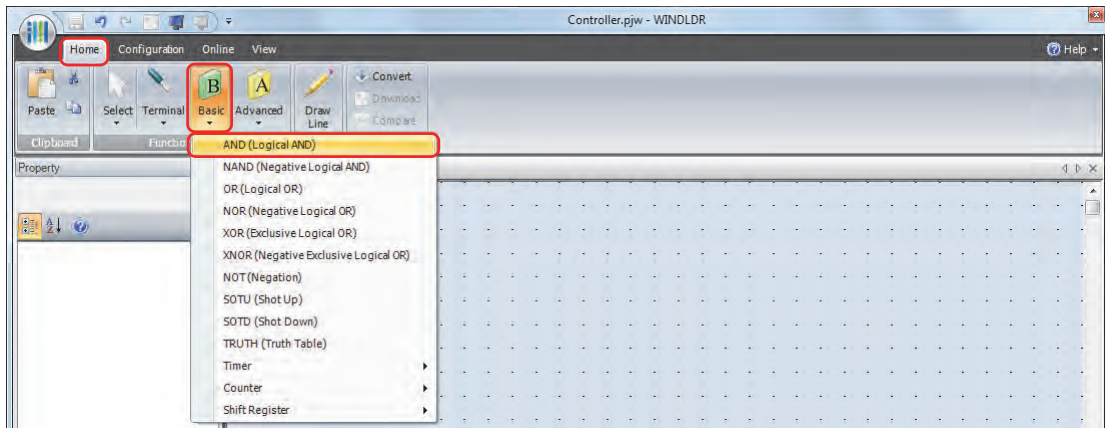

- 2 Move the mouse pointer to the FBD editor, and then click the mouse button. AND B0 is inserted at the position of the mouse pointer.

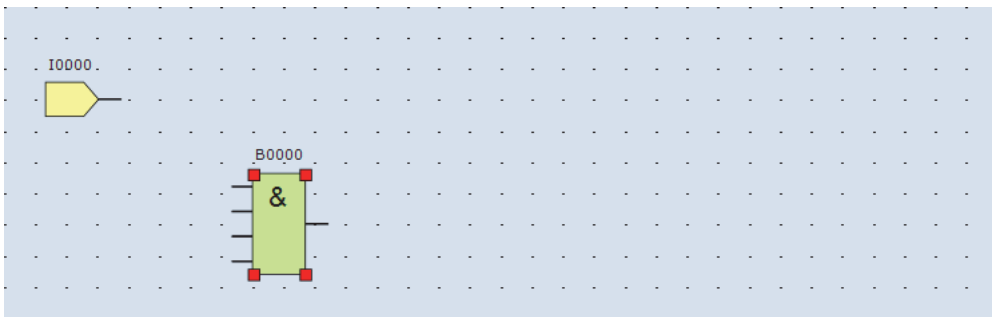
Connect input I0 and AND B0 with a connection line

- 1 On the WindLDR **Home** tab, in the **Line** group, click **Draw Line**.



- 2 Move the mouse pointer to the input I0 output connector.

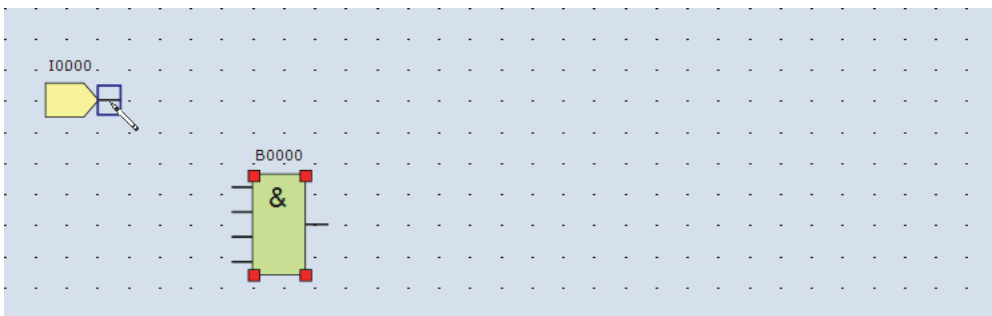

- 3 Click the mouse button and drag the line to the AND B0 input 1 connector.

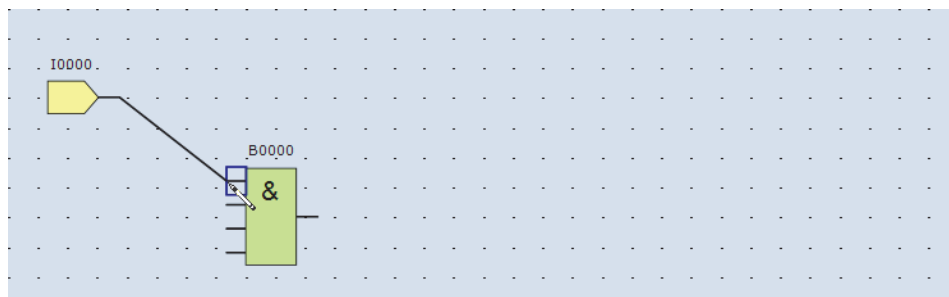

- 4 Release the mouse button.
The input IO output connector and the AND B0 input 1 connector are connected.

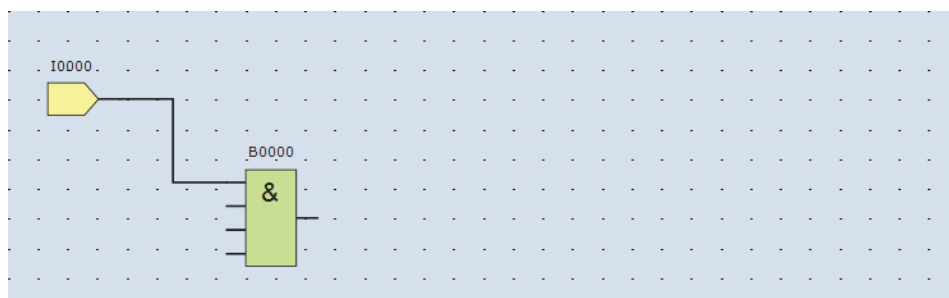

Insert output Q0 and connect it to the AND B0 output

- 1 On the WindLDR **Home** tab, in the **Function Block** group, click **Terminal**, and then click **Q (Digital Output)**.

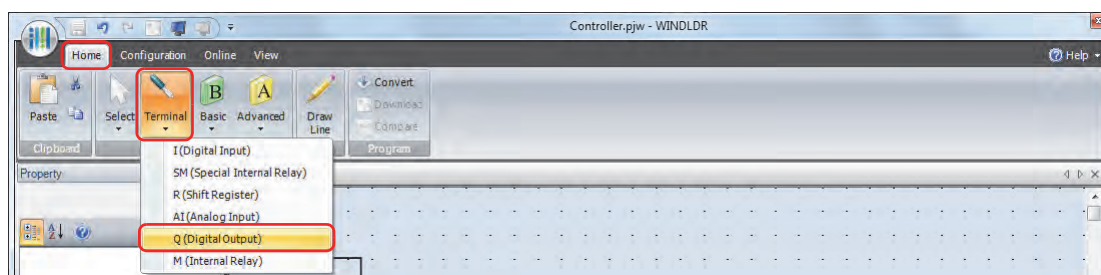

- 2 Move the mouse pointer to the FBD editor, and then click the mouse button.
Output Q0 is inserted at the position of the mouse pointer.

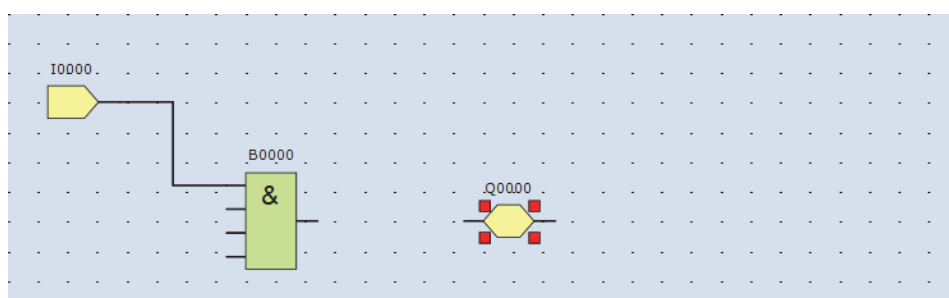

- 3 Connect the AND B0 output connector and the output Q0 input connector with a connection line.
Connect them in the same manner as "Connect input IO and AND B0 with a connection line" on page 12-34.

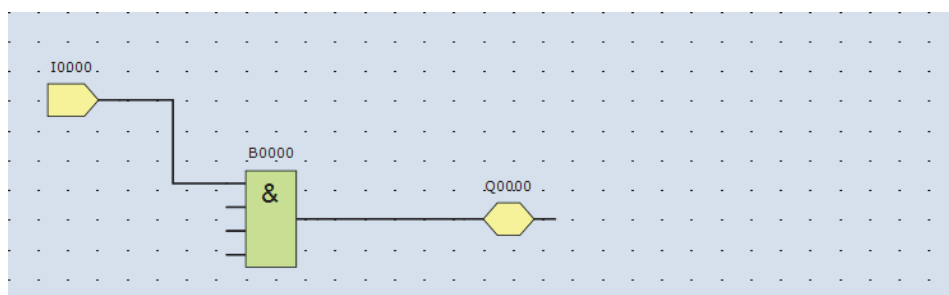

Insert input I1 and connect it to AND B0 input 2

Insert input I1 in the same manner as “Insert input I0” on page 12-33 and connect it with a connection line in the same manner as “Connect input I0 and AND B0 with a connection line” on page 12-34.

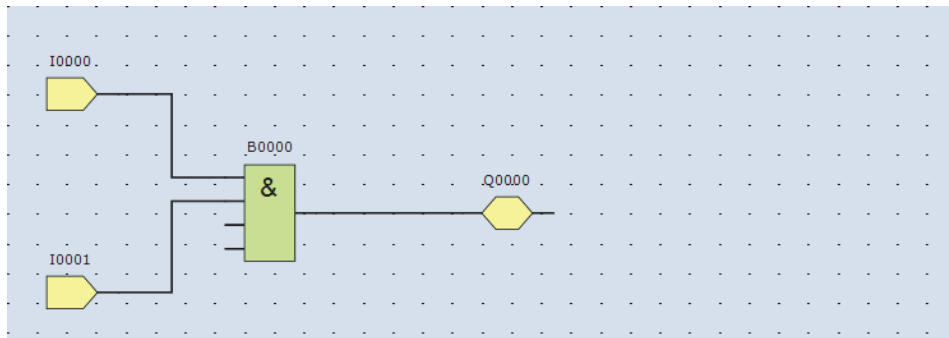
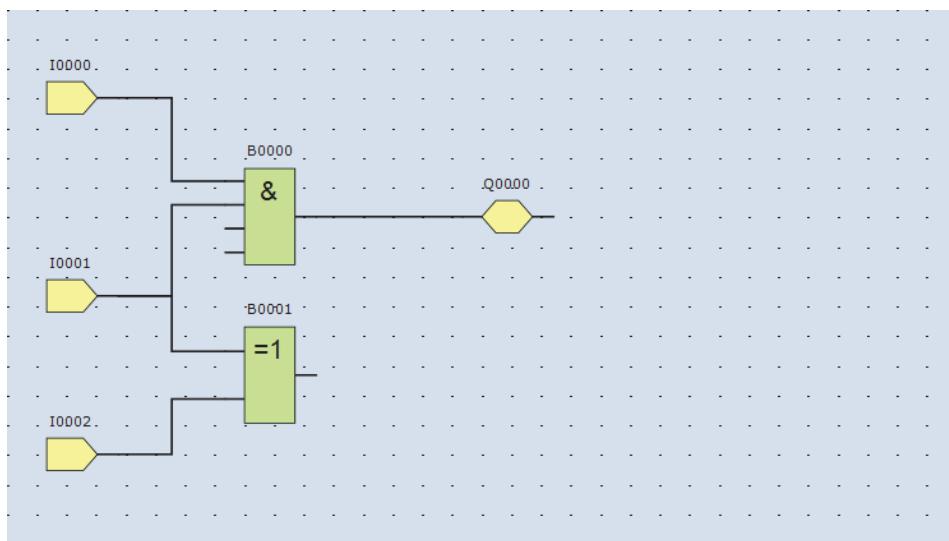
Insert input I2 and XOR B1 and connect input I1 and input I2 to XOR B1 input 1 and input 2

The FB output connectors can be connected to multiple FB input connectors. Multiple FB output connectors cannot be connected to a single FB input connector.

Insert special internal relay M8121, AND B2, and output Q1 and connect them with connection lines



M8121 is a special internal relay that repeatedly turns on and off in a one second cycle. For details on the special internal relay, refer to Chapter 27 “Special Internal Relay (M)” on page 27-5.

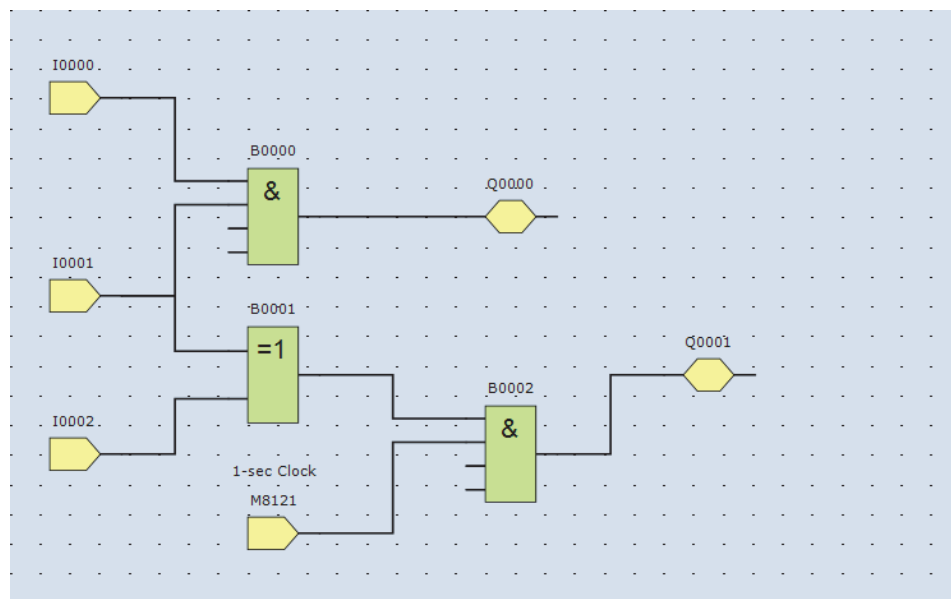

This completes the FBD program.

Conversion of Programs

- 1 Confirm that the program has been correctly created.
On the WindLDR **Home** tab, in the **Program** group, click **Convert**.
If the FBs are correctly connected, the conversion will be successful. If errors are found, a list of errors is displayed in the information window. Fix those errors in order.

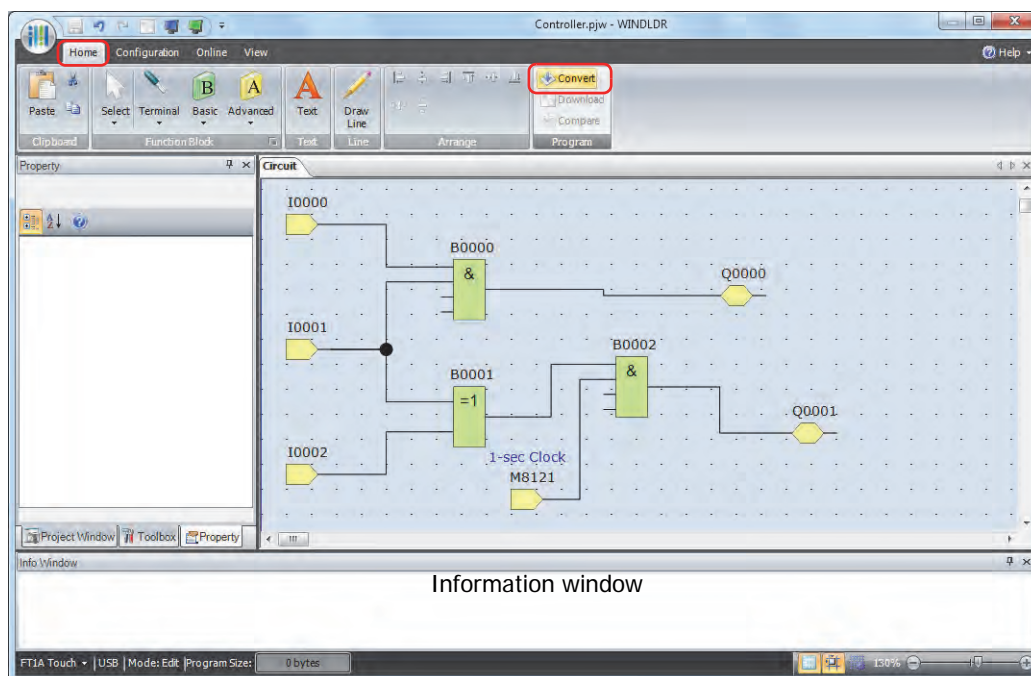

Monitor Operation

You can monitor the operation of the downloaded program with WindLDR's monitor function.

- 1 After the program is successfully downloaded, on the WindLDR **Online** tab, in the **Monitor** group, click **Monitor**. The Touch state is displayed on the WindLDR screen.

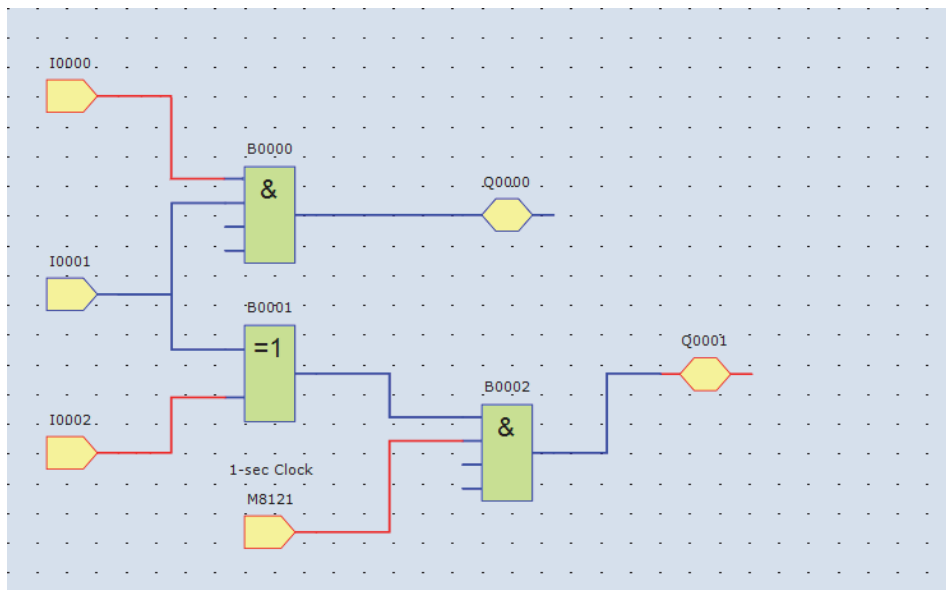

- 2 Monitor the following operations.

- When you turn on both input I0 and input I1, output Q0 turns on.
- When you turn on either input I1 or input I2, output Q1 repeatedly turns on and off in a one second cycle.

This concludes the monitor operation.





- You can monitor the state of the input connectors and output connectors for each FB. When input connectors, output connectors, and connection lines are red, they are on. Blue is off.
- For details on the state of unconnected input connectors in the FBs, refer to the chapters for the FBs in the "SmartAXIS FBD Programming Manual".

● Exit WindLDR

Click  in WindLDR, and then click **Exit WindLDR**.

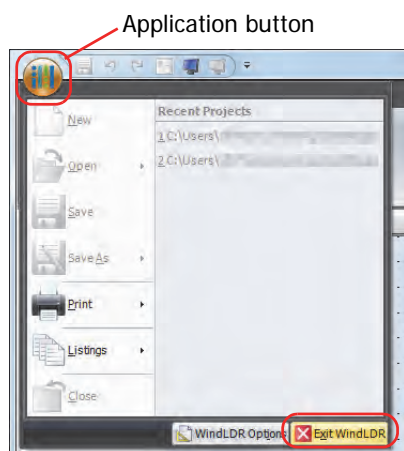
WindLDR closes.



- If project data is saved during editing in WindO/I-NV3, control function are also saved.
- If you click  in WindLDR and then click **Close**, or if you close the project file while editing in WindO/I-NV3, you will exit WindLDR.

3.2 FB Reference



In the FBD program, there are FBs such as logical operation FBs that perform logical operations, timer FB to perform processing using timer devices and counter FB to perform processing using counter devices. If the output of a FB is inverted, the execution results of the FB are inverted and output. For FBs that support inverted output, refer to the following table.



Programming and operating the user program of the SmartAXIS requires special knowledge.

To make effective use of the SmartAXIS, develop a thorough understanding of the contents of this manual and the FBD programming.

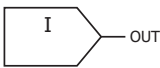
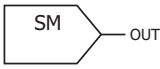
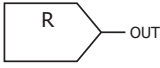



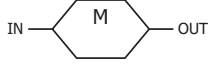

● Input FB

Symbol	Name and Diagram	Function	Output Inversion
I	Digital Input 	Inputs ON/OFF information from an external device to the Touch.	NO
SM	Special Internal Relay 	Special internal relays can be used as bit inputs for FBs. Special function is allocated to each special internal relay.	NO
R	Shift Register 	Outputs ON/OFF state of a shift register device.	NO
AI	Analog Input 	<ul style="list-style-type: none"> •For the analog inputs (AI0, AI1) in the Touch, the analog input values can be linearly converted with the AI FB parameter settings within the range of -32,768 to 32,767. •For the analog input cartridge (AI2 to AI5), the analog input values can be linearly converted with the function area settings. For how to configure the function area settings, refer to Chapter 3 "4.15 Analog Cartridge" on page 3-88. 	NO

● Output FB

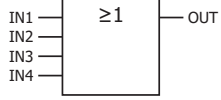
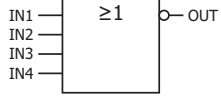
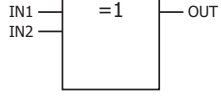
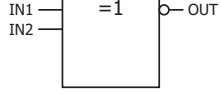
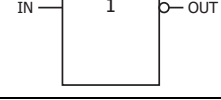
Symbol	Name and Diagram	Function	Output Inversion
Q	Digital Output 	Outputs ON/OFF information from the Touch to an external.	NO
M	Internal Relay 	A bit unit FB used internally in the Touch.	NO

● Logical Operation FB

Symbol	Name and Diagram	Function	Output Inversion
AND	Logical AND 	Implements logical AND for a maximum of four input signals (ON/OFF) and outputs the result.	NO
NAND	Negative Logical AND 	Implements negative logical AND for a maximum of four input signals (ON/OFF) and outputs the result.	NO
OR	Logical OR 	Implements logical OR for a maximum of four input signals (ON/OFF) and outputs the result.	NO
NOR	Negative Logical OR 	Implements negative logical OR for a maximum of four input signals (ON/OFF) and outputs the result.	NO
XOR	Exclusive Logical OR 	Implements exclusive logical OR for a maximum of two input signals (ON/OFF) and outputs the result.	NO
XNOR	Negative Exclusive Logical OR 	Implements negative exclusive logical OR for a maximum of two input signals (ON/OFF) and outputs the result.	NO
NOT	Negation 	Outputs the result of negating the input signal (ON/OFF).	NO
SOTU	Shot Up 	Turns on the output for one scan when the input signal turns from off to on.	NO
SOTD	Shot Down 	Turns on the output for one scan when the input signal turns from on to off.	NO
TRUTH	Truth Table 	A truth table for the output can be configured corresponding to the 16 combination of the four input signals, and TRUTH FB outputs the result according to the table.	YES

● Timer FB

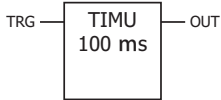
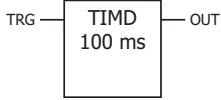
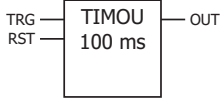
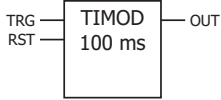
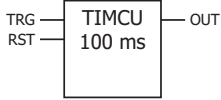
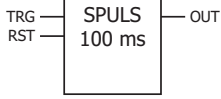
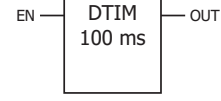
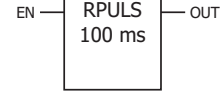
Symbol	Name and Diagram	Function	Output Inversion
TIMU	On-delay Count Up Timer 	After the execution input turns on, the output is turned on when the on-delay time elapses. The current value is incremented from zero to the preset value.	NO
TIMD	On-delay Count Down Timer 	After the execution input turns on, the output is turned on when the on-delay time elapses. The current value is decremented from the preset value to zero.	NO
TIMOU	Off-delay Count Up Timer 	When the execution input turns on, the output is turned on. After the execution input turns off, the output is turned off when the off-delay time elapses. The current value is incremented from zero to the preset value.	NO
TIMOD	Off-delay Count Down Timer 	When the execution input turns on, the output is turned on. After the execution input turns off, the output is turned off when the off-delay time elapses. The current value is decremented from the preset values to zero.	NO
TIMCU	On/off-delay Timer 	After the execution input turns on, the output is turned on when the on-delay time elapses. After the execution input turns off, the output is turned off when the off-delay time elapses.	NO
SPULS	Single Shot Pulse 	After the execution input turns on, the output is turned on for the configured time period.	NO
DTIM	Dual Timer 	The output is turned on and off according to the configured ON and OFF time.	NO
RPULS	Random Pulse Output 	The output is turned on for the length of random time within the configured range of time.	NO

● Counter FB

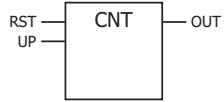
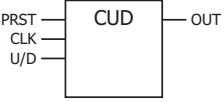
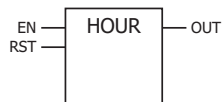
Symbol	Name and Diagram	Function	Output Inversion
CNT	Adding Counter 	When the clock input is turned on, the current value is incremented by one. The output is turned on when the current value reaches the preset value.	NO
CUD	Up/Down Selection Reversible Counter 	When the clock input is turned on, the current value is incremented or decremented by one according to the up/down selection input. The current value is compared with ON/OFF thresholds. The output is turned on or off according to the comparison result.	NO
HOUR	Hour Meter 	Accumulates the ON duration of the execution input in hours, minutes, and seconds. The output is turned on when the accumulated time reaches the configured time.	NO

● Shift Register FB

Symbol	Name and Diagram	Function	Output Inversion
SFR	Shift Register 	When the execution input turns on, the shift registers are shifted to the specified shift direction.	YES

● Data Comparison FB

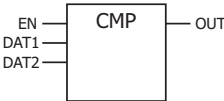
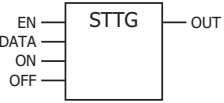
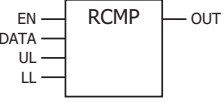
Symbol	Name and Diagram	Function	Output Inversion
CMP	Data Comparison 	Two comparison values are compared and the output is turned on or off according to the comparison result.	YES
STTG	Schmitt Trigger 	The comparison value and the ON/OFF thresholds are compared and the output is turned on or off according to the comparison result.	YES
RCMP	Range Comparison 	The comparison value and the upper/lower limits are compared and the output is turned on or off according to the comparison result.	YES

● Data Conversion FB

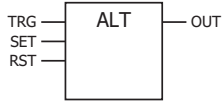
Symbol	Name and Diagram	Function	Output Inversion
ALT	Alternate Output 	Sets/resets the output.	YES

● Week Programmer FB

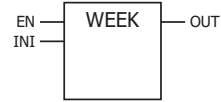
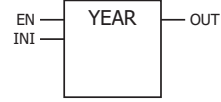
Symbol	Name and Diagram	Function	Output Inversion
WEEK	Weekly Timer 	Compares the specified day of the week, ON time, and OFF time with the current time and outputs the result.	NO
YEAR	Yearly Timer 	Compares the specified date with the current date and outputs the result.	NO

● Script FB

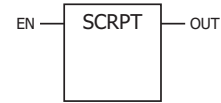
Symbol	Name and Diagram	Function	Output Inversion
SCRPT	Script 	Enables you to program complicated processing with the script language that supports conditional branching, logical operations, arithmetic operations, and functions.	NO

● Special FB

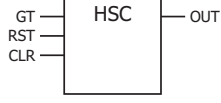
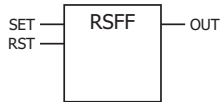
Symbol	Name and Diagram	Function	Output Inversion
HSC	High-speed Counter 	Operates the high-speed counter configured in the function area settings. Turns on/off the high-speed counter gate input/clear input.	YES
RSFF	RS Flip-flop 	When the set input turns on, the output turns on and is kept on. When the reset input turns on, the output turns off.	YES

● Available Data

The available data types for each FB are as follows.



In WindLDR data types are displayed as follows: BIN16(+) as W (word), BIN16(+/-) as I (integer), BIN32(+) as D (double word), BIN32(+/-) as L (long), and float32 as F (float).

FB			Data type				
			W	I	D	L	F
Group	Name	Symbol	Word	Integer	Double word	Long	Float
Input	Digital Input	I	NO	NO	NO	NO	NO
	Special Internal Relay	SM	NO	NO	NO	NO	NO
	Shift Register	R	NO	NO	NO	NO	NO
	Analog Input	AI	YES ^{*1}	YES ^{*1}	NO	NO	NO
Output	Digital Output	Q	NO	NO	NO	NO	NO
	Internal Relay	M	NO	NO	NO	NO	NO
Logical Operation	Logical AND	AND	NO	NO	NO	NO	NO
	Negative Logical AND	NAND	NO	NO	NO	NO	NO
	Logical OR	OR	NO	NO	NO	NO	NO
	Negative Logical OR	NOR	NO	NO	NO	NO	NO
	Exclusive Logical OR	XOR	NO	NO	NO	NO	NO
	Negative Exclusive Logical OR	XNOR	NO	NO	NO	NO	NO
	Negation	NOT	NO	NO	NO	NO	NO
	Shot Up	SOTU	NO	NO	NO	NO	NO
	Shot Down	SOTD	NO	NO	NO	NO	NO
Truth Table	TRUTH	NO	NO	NO	NO	NO	
Timer	On-delay Count Up Timer	TIMU	YES	NO	NO	NO	NO
	On-delay Count Down Timer	TIMD	YES	NO	NO	NO	NO
	Off-delay Count Up Timer	TIMOU	YES	NO	NO	NO	NO
	Off-delay Count Down Timer	TIMOD	YES	NO	NO	NO	NO
	On/off-delay Timer	TIMCU	YES	NO	NO	NO	NO
	Single Shot Pulse	SPULS	YES	NO	NO	NO	NO
	Dual Timer	DTIM	YES	NO	NO	NO	NO
	Random Pulse Output	RPULS	YES	NO	NO	NO	NO
Counter	Adding Counter	CNT	YES	NO	YES	NO	NO
	Up/Down Selection Reversible Counter	CUD	YES	NO	YES	NO	NO
	Hour Meter	HOUR	YES	NO	NO	NO	NO
Shift Register	Shift Register	SFR	NO	NO	NO	NO	NO
Data Comparison	Data Comparison	CMP	YES	YES	YES	YES	NO
	Schmitt Trigger	STTG	YES	YES	YES	YES	NO
	Range Comparison	RCMP	YES	YES	YES	YES	NO
Data Conversion	Alternate Output	ALT	NO	NO	NO	NO	NO
Week Programmer	Weekly Timer	WEEK	NO	NO	NO	NO	NO
	Yearly Timer	YEAR	NO	NO	NO	NO	NO
Script	Script	SCRPT	YES	YES	YES	YES	YES
Special	High-speed Counter	HSC	YES	NO	YES	NO	NO
	RS Flip-flop	RSFF	NO	NO	NO	NO	NO

*1 Analog inputs (AI0, AI1) do not support the word type. When using the analog input cartridge (AI2 to AI5), configure the AI FB data type in the function area settings. For how to configure the function area settings, refer to Chapter 3 "4.15 Analog Cartridge" on page 3-88.

4 Remote I/O

4.1 Overview

When you want to increase the number of I/Os to be connected to a single Touch, you can achieve this using the remote I/O function.

In addition to the built-in I/Os of the Touch, you can expand the number of I/Os up to a maximum of 90 inputs and 54 outputs.

Configure the Touch to which inputs and outputs need to be expanded as the remote I/O master, and configure the Pro/Lite to be the remote inputs and outputs as the remote I/O slaves.

The remote I/O master is configured on connections 1 through 3 in the Function Area Settings dialog box.

The Touch configured as a remote I/O master can connect to one remote I/O slave per one connection. When the connections 1 through 3 are all used for remote I/O, the remote I/O master can connect to a maximum of three remote I/O slaves.

For the remote I/O slave function and configuration procedure, refer to the "SmartAXIS Pro/Lite User's Manual".

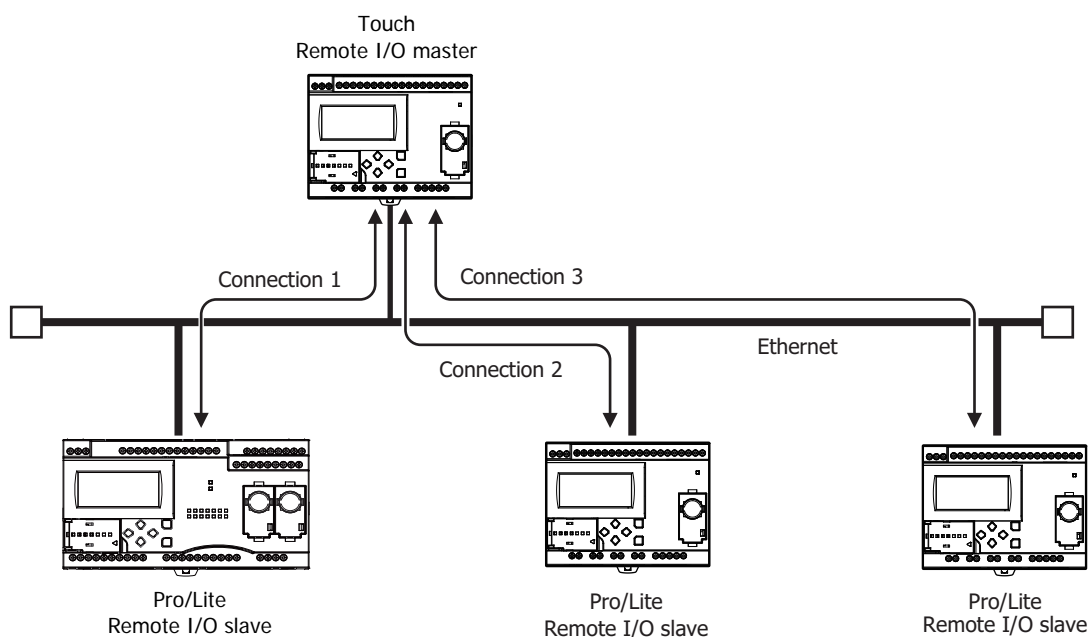

- If a communication timeout occurs at a remote I/O slave, all outputs of the remote I/O slave are turned off.

Depending on the details of the control on the remote I/O slave side, this may lead to a hazardous situation, so set the master receive timeout to an ample length. If the master receive timeout setting is made long, the time that the remote I/O slave outputs remain on also becomes long when communication is actually lost. Set the master receive timeout to a value suited to each application.

- The SmartAXIS configured as remote I/O master/slave communicates over Ethernet. When other SmartAXIS or other network devices are connected on the same LAN, the I/O refresh timing for the remote I/O slaves is affected by those devices.

4.2 Remote I/O Master

The Touch can be used as a remote I/O master by configuring the Touch as a remote I/O master in WindLDR. The settings can be configured in the Function Area Settings dialog box of WindLDR.

The digital input information from the remote I/O slaves connected with connection 1 through 3 is input to I40 to I75, I80 to I115, and I120 to I155. The analog input information from the remote I/O slaves is stored to D8149 to D8156, D8158 to D8165, and D8167 to D8174.

The output information for Q40 to Q61, Q80 to Q101, and Q120 to Q141 on the remote I/O master is output from the remote I/O slaves connected with connection 1 through 3. For details on data communication between the remote I/O master and the remote I/O slaves, refer to "Remote I/O Communication Memory Refresh Image" on page 12-48.

● Specifications

Item		Description	
Connection 1	Digital inputs	I40 to I75	
	Digital outputs	Q40 to Q61	
	Analog inputs	D8149 (=AI10) to D8156 (=AI17)	
	Remote I/O slave 1 communication error status	D8148	
	Remote I/O slave 1 communication error	M8005	
	Remote host	IP address	000.000.000.000 to 255.255.255.255
		Port number	0 to 65535
Timeout	100 ms to 25,500 ms (100 ms increments)		
Connection 2	Digital inputs	I80 to I115	
	Digital outputs	Q80 to Q101	
	Analog inputs	D8158 (=AI20) to D8165 (=AI27)	
	Remote I/O slave 2 communication error status	D8157	
	Remote I/O slave 2 communication error	M8006	
	Remote host	IP address	000.000.000.000 to 255.255.255.255
		Port number	0 to 65535
Timeout	100 ms to 25,500 ms (100 ms increments)		
Connection 3	Digital inputs	I120 to I155	
	Digital outputs	Q120 to Q141	
	Analog inputs	D8167 (=AI30) to D8174 (=AI37)	
	Remote I/O slave 3 communication error status	D8166	
	Remote I/O slave 3 communication error	M8007	
	Remote host	IP address	000.000.000.000 to 255.255.255.255
		Port number	0 to 65535
Timeout	100 ms to 25,500 ms (100 ms increments)		
Refresh period	Communication processing	Scan asynchronous	
	Data update	Each scan end	

● Remote I/O Communication Memory Refresh Image

Data communication between the remote I/O master and the remote I/O slaves is conducted as shown in the diagram below.

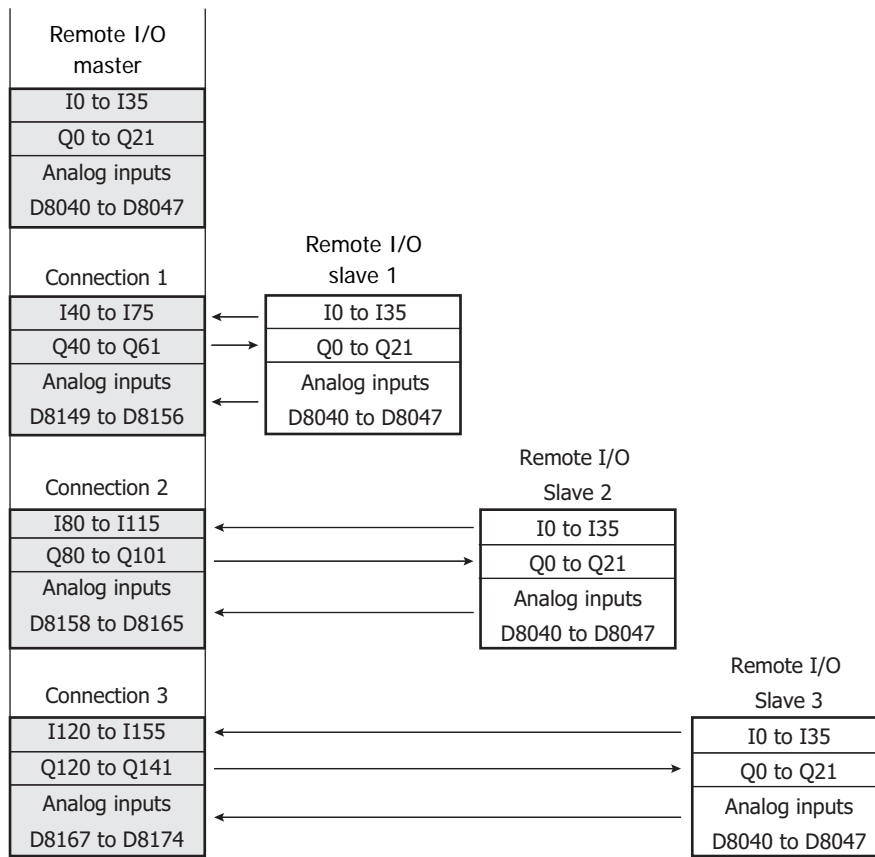

● Connection Status with Remote I/O Slaves

The connections status of each remote I/O slave can be confirmed by referring to the special internal relays and special data registers of the SmartAXIS configured as the remote I/O master.

Item	Connection port	Device	Description
Connection status	Connection 1	M8110	Indicates the connection status with the corresponding slave. OFF: Not connected, ON: Connected
	Connection 2	M8111	
	Connection 3	M8112	
IP address of the connected slave	Connection 1	D8110 to D8113	Stores the IP address of the slave.
	Connection 2	D8114 to D8117	
	Connection 3	D8118 to D8121	
Port number of the connected slave	Connection 1	D8130	Stores the connected port number of the slave.
	Connection 2	D8131	
	Connection 3	D8132	

● Communication Error Information with the Remote I/O Slaves

Communication errors with the remote I/O slaves can be confirmed by referring to M8005 to M8007 (remote I/O slave communication error). The details of the communication error can be confirmed by referring to D8148, D8157, and D8166 (remote I/O slave communication error status).

Item	Device	Description
Remote I/O slave 1 communication error	M8005	ON: Communication error occurs (ON while the error is occurring) OFF: Communicating normally
Remote I/O slave 2 communication error	M8006	
Remote I/O slave 3 communication error	M8007	
Remote I/O slave 1 communication error status	D8148	0: Normal 1: Communication timeout error 2: Connection disconnected 10: Slave output error*1
Remote I/O slave 2 communication error status	D8157	
Remote I/O slave 3 communication error status	D8166	

*1 The remote I/O master can communicate with the remote I/O slave, but this state indicates a system error has occurred on the remote I/O slave. Check the status of the remote I/O slave.

● Remote I/O Communication Timing Chart

Establish connection

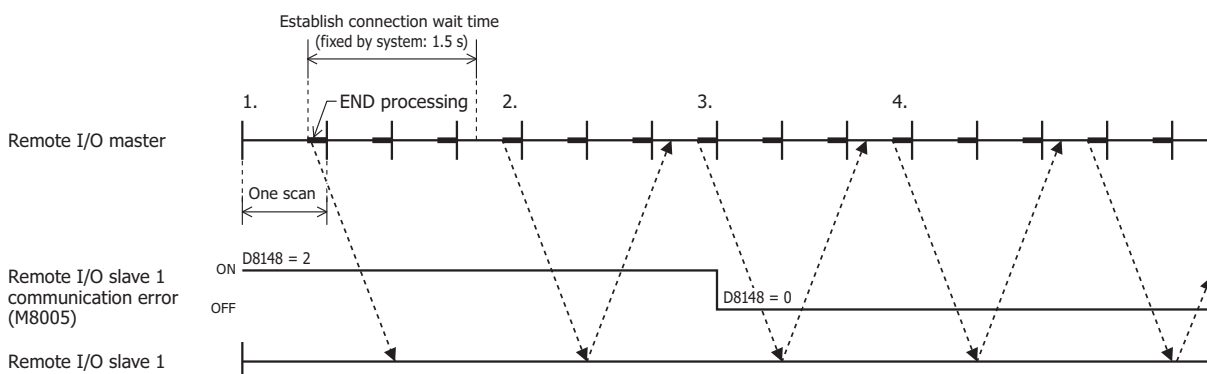

The remote I/O master issues a communication request to the remote I/O slave in the END processing.

1. The remote I/O master's initial state is that the remote slave communication error (M8005 to M8007) is on and the remote slave communication error status (D8148, D8157, D8166) is "2" (connection disconnected).
2. The remote I/O master attempts to establish a connection with remote I/O slave 1, but the connection cannot be established. At the event above, the remote I/O slave 1 communication error (M8005) is kept on, and the remote I/O slave 1 communication status (D8148) is kept as "2" (connection disconnected).
3. When the connection is successfully established afterward, the remote I/O slave 1 communication error (M8005) turns off, and the remote I/O slave 1 communication error status (D8148) also becomes "0" (normal).
4. Communication with remote I/O slave 1 is continued.

Communication timeout

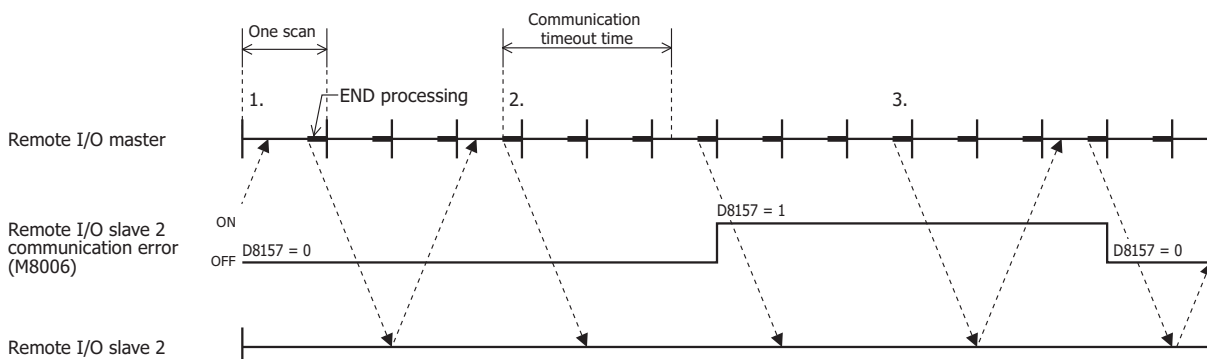

1. While communicating with the remote I/O slave, the remote slave communication error (M8005 to M8007) is off and the remote slave communication error status (D8148, D8157, D8166) is "0" (normal).
2. If the response for a request issued to remote I/O slave 2 takes longer than the communication timeout, the remote I/O slave 2 communication error (M8006) turns on and the remote I/O slave 2 communication error status (D8157) becomes "1" (communication timeout error).
3. When a response from remote I/O slave 2 is returned, the remote I/O slave 2 communication error (M8006) turns off, and the remote I/O slave 2 communication error status (D8157) becomes "0" (normal).

Communication with Multiple Remote I/O Slaves

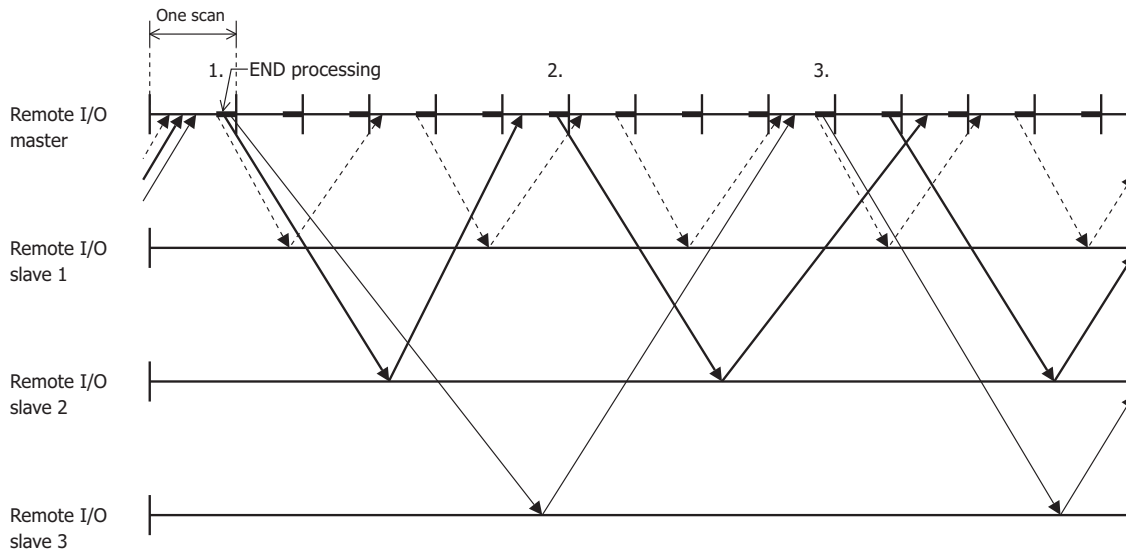

The above timing chart is an example where the communication with remote I/O slave 1 is the fastest and the communication with remote I/O slave 3 is the slowest.

1. The remote I/O master is able to perform remote I/O communication in END processing and it simultaneously issues requests to all remote I/O slaves.
2. The time until the response is returned is affected by the state of the network connecting the remote I/O slaves. Therefore, new requests are only issued for remote I/O slaves that have returned a response.
3. When multiple responses are received in one scan, new requests are issued for all of those simultaneously in END processing.



Remote Communication Speed

The communication speed in remote I/O communication is affected by such factors as the state of the network line and the communication cable. As a reference for communication speed, when performing remote I/O communication using a 100BASE-T compatible cable and switching hub, it takes a minimum of approximately 5 ms after the remote I/O master issues a request until the response from the remote I/O slave is reflected as inputs.

- Procedure

To use the Touch as a remote I/O master, you must configure the **Function Area Settings** tab and download the ladder program or FBD program to the Touch.

- 1 On the WindO/I-NV3 **View** tab, in the **Workspace** group, click  (Control Function) .

WindLDR starts.

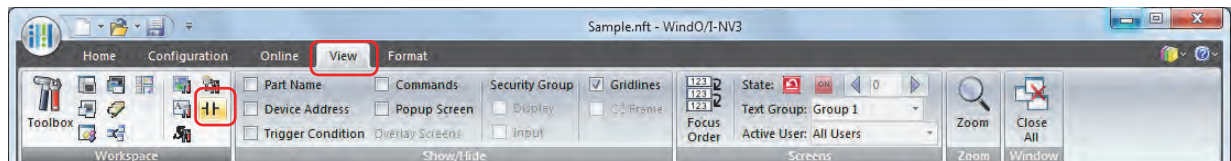

- 2 On the WindLDR **Configuration** tab, in the **Function Area Settings** group, click **Connection Settings**.

The Function Area Settings dialog box is displayed.

- 3 Click **Communication Mode** for the connection to configure, and then select **Remote I/O Master**.

The Remote I/O Master dialog box is displayed.

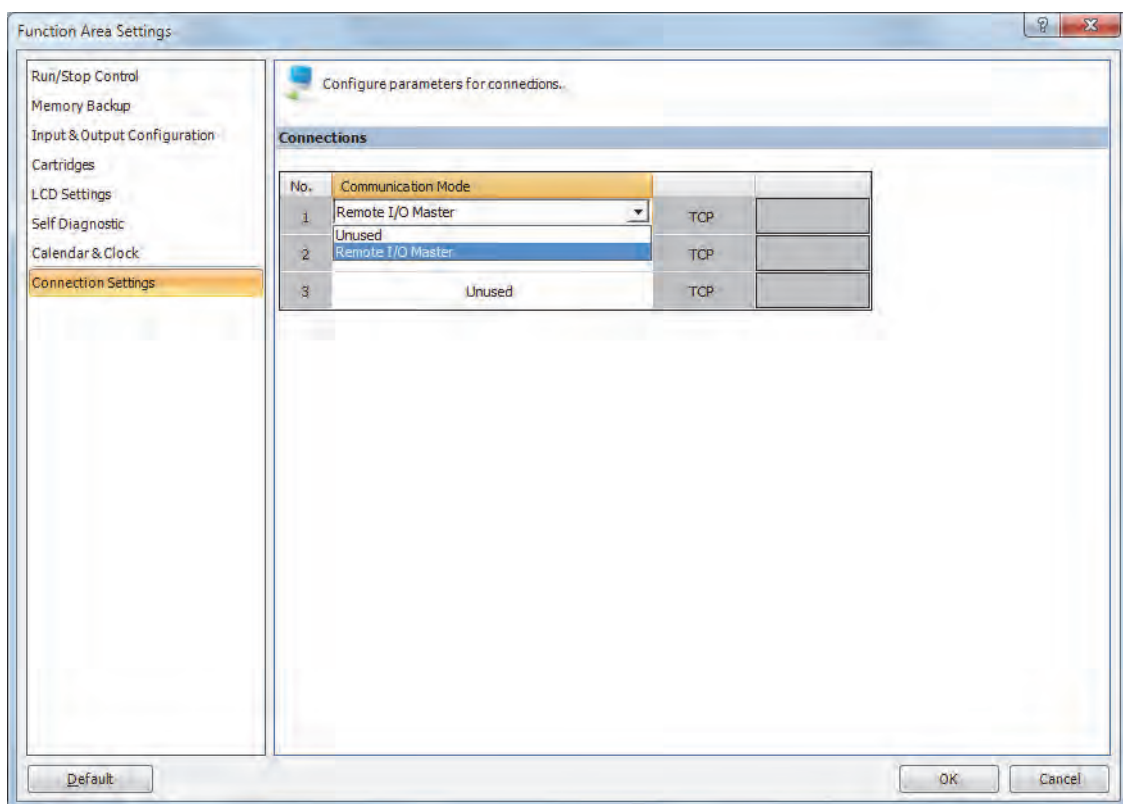

- 4 Click **Remote Host No.** and select **New Remote Host...**

The Remote Host dialog box is displayed.

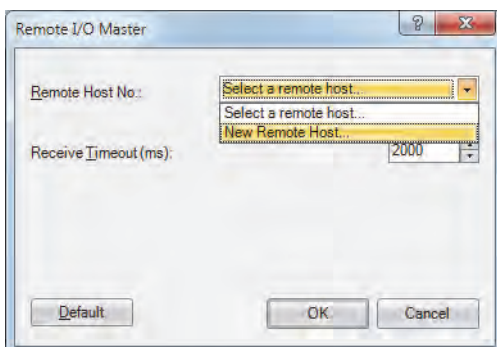

- 5 Configure **IP Address** and **Port** of the remote I/O slave to connect.

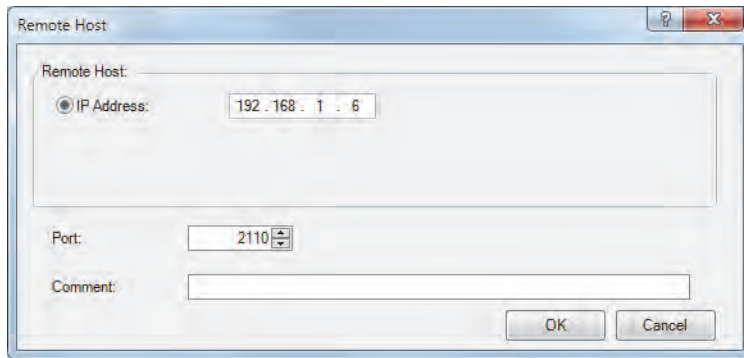

The default port number of the remote I/O slave is 2110.

- 6 Click **OK**.
When the settings are correctly configured, the details configured in the Remote Host dialog box is displayed in **Remote Host No.**
- 7 For **Receive Timeout (ms)**, configure the receive timeout with the remote I/O slave.

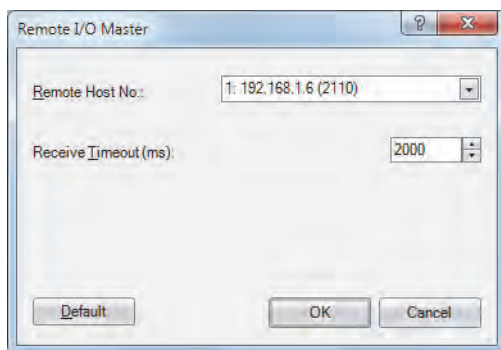

- 8 Click **OK**.
Configuring the remote I/O master is completed.

Chapter 13 Alarm Log Function

This chapter describes how to configure the Alarm Log function and its operation on the Touch.

1 Overview

1.1 How the Alarm Log Function is Used

The Alarm Log function samples the occurrence of alarms and recovery information by monitoring and evaluating the state of devices.

The Alarm Log function can perform the following functions.

- Monitor device states and create Alarm Log data

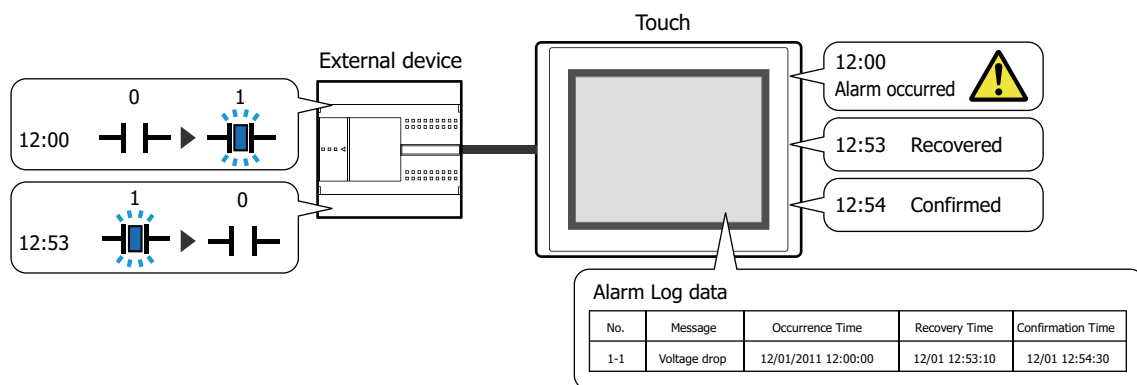

- Monitor device states and detect alarms

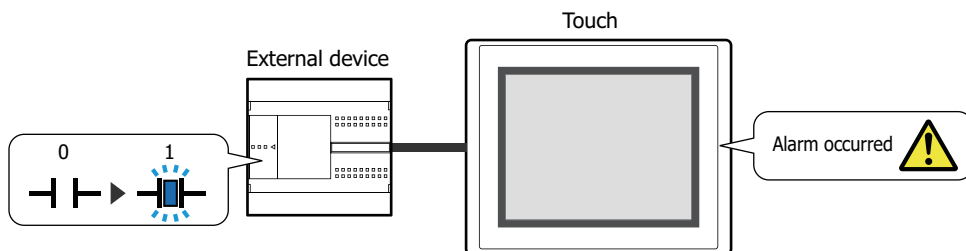

- Display an alarm screen when an alarm occurs

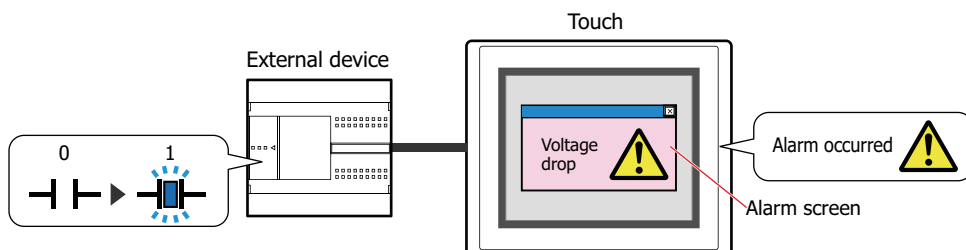

- Make a sound of the buzzer and screen flashing the screen when an alarm occurs

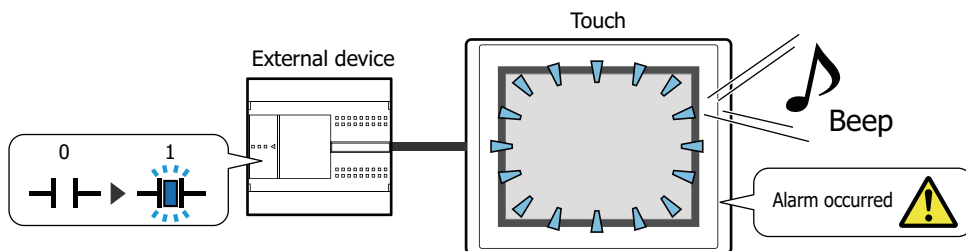

- Output Alarm Log data to the external memory

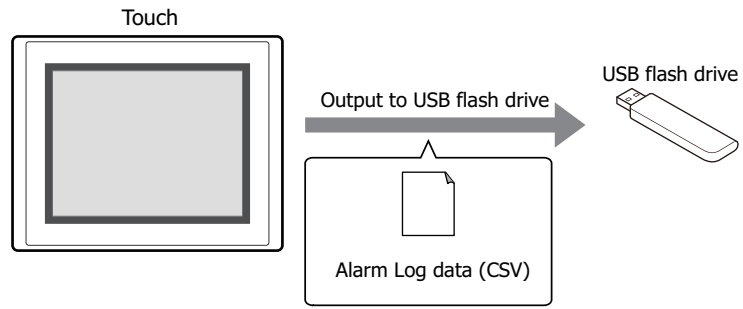

1.2 Alarm States

Alarms have three states: occurred, recovered, and confirmed.

Alarm state	Details
Occurred	Indicates that an alarm has occurred. There are two types of alarms that occur. First Alarm: The first alarm that occurs in a state where no alarms have occurred. Second and later: An alarm that has occurred while another alarm is active.
Recovered	Indicates that the alarm that occurred has been recovered from. However, for channels set to lock, the alarm is not recovered from until a key button is pressed (CHECK or All Chk.).
Confirmed	Indicates the key button CHECK or All Chk. was pressed.

Example: When the source device (the device to monitor) is D100-0, the error state (when an alarm has occurred) is ON, the channel is set to **Unlock**, and the used key button is **CHECK**
When the source device is ON, the alarm changes to the "Occurred" state. When the source device is OFF, the alarm changes to the "Recovered" state. When **CHECK** is pressed, the alarm changes to the "Confirmed" state.

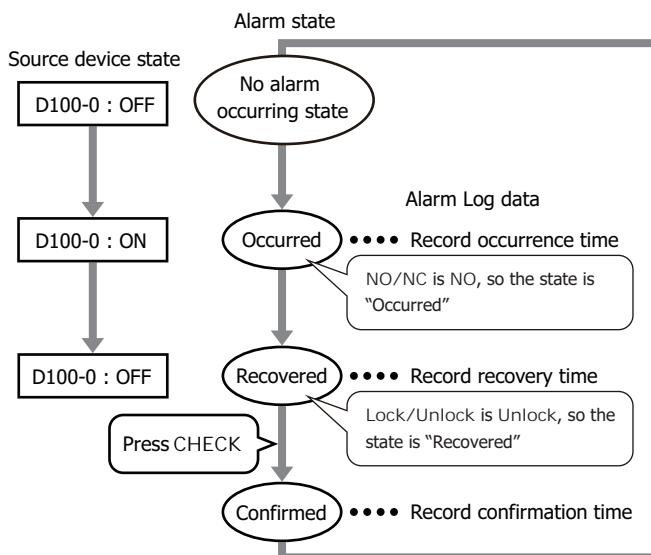

If **CHECK** is pressed before the source device changes to OFF, the alarm changes to the "Confirmed" state regardless of the state of the source device.

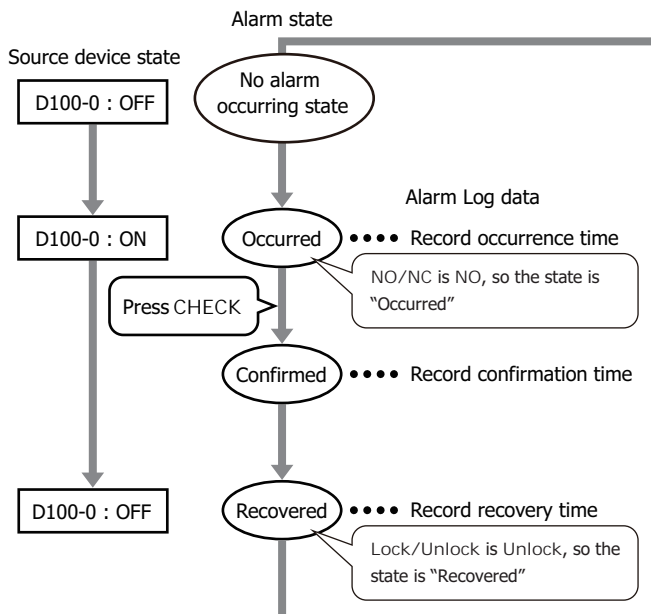

1.3 Sampling Data

Data is sampled each time the alarm occurs, is recovered from, or confirmed.

Example: When the message for channel number 1-1 is "Voltage drop" and the message for channel number 1-2 is "Temperature abnormal"

1	Channel No. 1-1: Alarm occurred (12:50:00)	Ch.No.	Message	Occurrence Time	Recovery Time	Confirmation Time
	Channel No. 1-2: No alarm	1-1	Voltage drop	12/01/2011 12:50:00	-	-
2	Channel No. 1-1: Alarm (12:50:00)	Ch.No.	Message	Occurrence Time	Recovery Time	Confirmation Time
	Channel No. 1-2: Alarm occurred (12:50:10)	1-1	Voltage drop	12/01/2011 12:50:00	-	-
3	Channel No. 1-1: Recovered from alarm (12:50:20)	Ch.No.	Message	Occurrence Time	Recovery Time	Confirmation Time
	Channel No. 1-2: Alarm (12:50:10)	1-1	Voltage drop	12/01/2011 12:50:00	12/01 12:50:20	-
4	Channel No. 1-1: CHECK pressed (12:50:30)	Ch.No.	Message	Occurrence Time	Recovery Time	Confirmation Time
	Channel No. 1-2: Alarm (12:50:10)	1-1	Voltage drop	12/01/2011 12:50:00	12/01 12:50:20	12/01 12:50:30
5	Channel No. 1-1: Alarm occurred (12:51:00)	Ch.No.	Message	Occurrence Time	Recovery Time	Confirmation Time
	Channel No. 1-2: Alarm (12:50:10)	1-1	Voltage drop	12/01/2011 12:50:00	12/01 12:50:20	12/01 12:50:30
		1-2	Temperature abnormal	12/01/2011 12:50:10	-	-
6	Channel No. 1-1: Alarm (12:51:00)	Ch.No.	Message	Occurrence Time	Recovery Time	Confirmation Time
	Channel No. 1-2: CHECK pressed (12:52:10)	1-1	Voltage drop	12/01/2011 12:50:00	12/01 12:50:20	12/01 12:50:30
		1-2	Temperature abnormal	12/01/2011 12:50:10	-	12/01 12:52:10
7	Channel No. 1-1: Alarm (12:51:00)	Ch.No.	Message	Occurrence Time	Recovery Time	Confirmation Time
	Channel No. 1-2: Recovered from alarm (12:52:10)	1-1	Voltage drop	12/01/2011 12:50:00	12/01 12:50:20	12/01 12:50:30
		1-2	Temperature abnormal	12/01/2011 12:50:10	12/01 12:53:00	12/01 12:52:10
		1-1	Voltage drop	12/01/2011 12:51:00	-	-

1.4 Data Configuration

The sampled data is composed of the channel number, message, alarm state, time, and label.
The relationship between the Alarm Log function settings and the sampled data is as follows.

Alarm Log settings

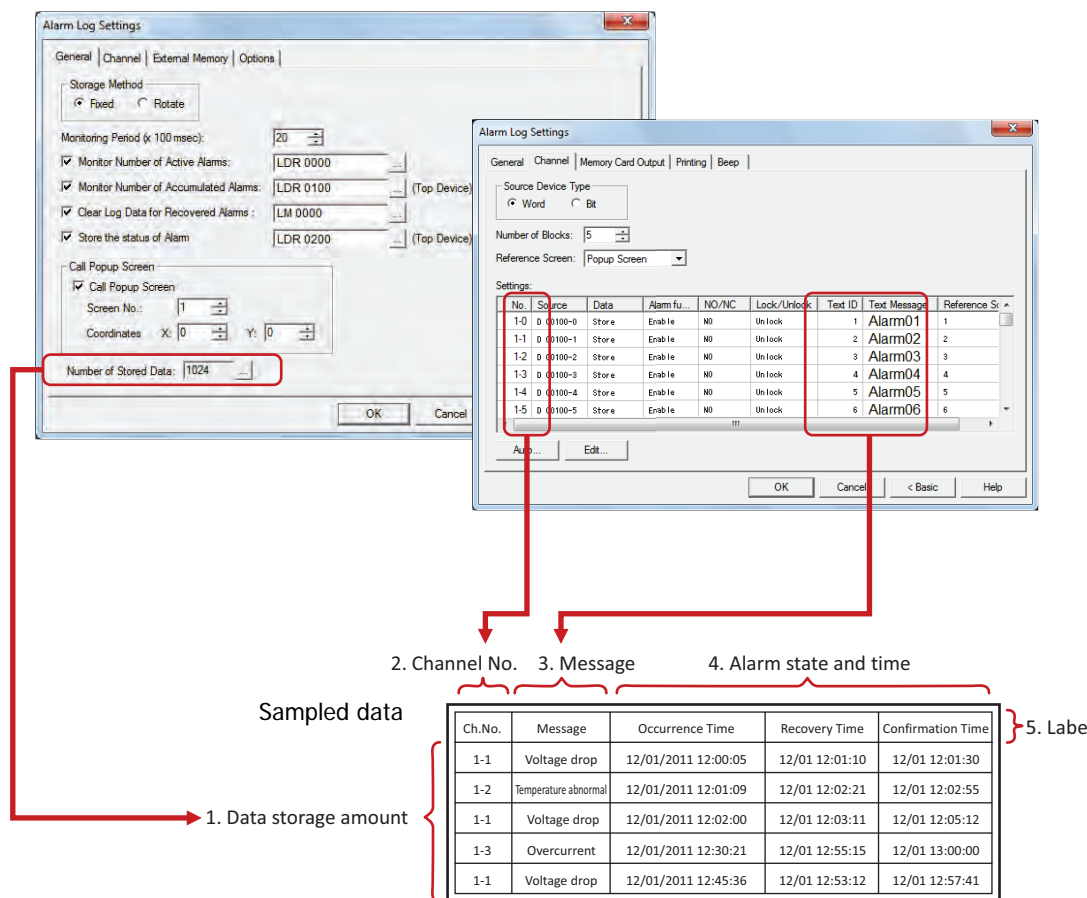

1. Data storage amount: The amount of data that can be saved in the data storage area. For details, refer to “Data Storage Amount” on page 13-7.
2. Channel No.: Composed of (Block No.)-(Channel No.). The devices to monitor and the conditions for alarm occurrence and recovery are configured in the channels. When the sampled data is output as a CSV file, the displayed label is “Ch.No.”.
3. Message: The message displayed when an alarm has occurred.
4. Alarm state and time: The alarm state (occurred, recovered, confirmed) and the time the alarm occurred, was recovered from, and confirmed. When the sampled data is output as a CSV file, the displayed label varies based on the output method.
5. Label: When the sampled data is output as a CSV file, this is the text displayed in the label row. This cannot be changed.

For sampled data, the format for displayed items varies based on the output method.

■ Batch

Batch output shows the recovery and confirmation time for an alarm that has occurred on a single line.

The labels displayed in the label row are "Ch.No.", "Message", "Occurrence Time", "Recovery Time", and "Confirmation Time".

Example: When the message for channel number 1-1 is "Voltage drop" and the message for channel number 1-2 is "Temperature abnormal"

Ch.No.	Message	Occurrence Time	Recovery Time	Confirmation Time
1-1	Voltage drop	12/01/2011 12:50:00	12/01 12:50:20	12/01 12:50:30
1-2	Temperature abnormal	12/01/2011 12:50:10	--	12/01 12:52:10
1-1	Voltage drop	12/01/2011 12:51:00	--	--

■ Real Time

Real time output displays the alarm state and the time the alarm became that state on a single line each time an alarm occurs, is recovered from, or is confirmed.

The labels displayed in the label row are "Ch.No.", "Message", "State", and "Time".

Example: When the message for channel number 1-1 is "Voltage drop" and the message for channel number 1-2 is "Temperature abnormal"

Ch.No.	Message	State	Time
1-1	Voltage drop	Occurred	12/01/2011 12:50:00
1-2	Temperature abnormal	Occurred	12/01/2011 12:50:10
1-1	Voltage drop	Recovered	12/01/2011 12:50:20

1.5 Saving and Deleting Data

● Saving Data

You can select whether or not to save the sampled data in the data storage area. The method to save data is configured on the **Channel** tab in the Alarm Log Settings dialog box.

When Saving Data to the Data Storage Area

Select **Store** under **Data** in the Auto-Setup dialog box or in the Individual Settings dialog box.

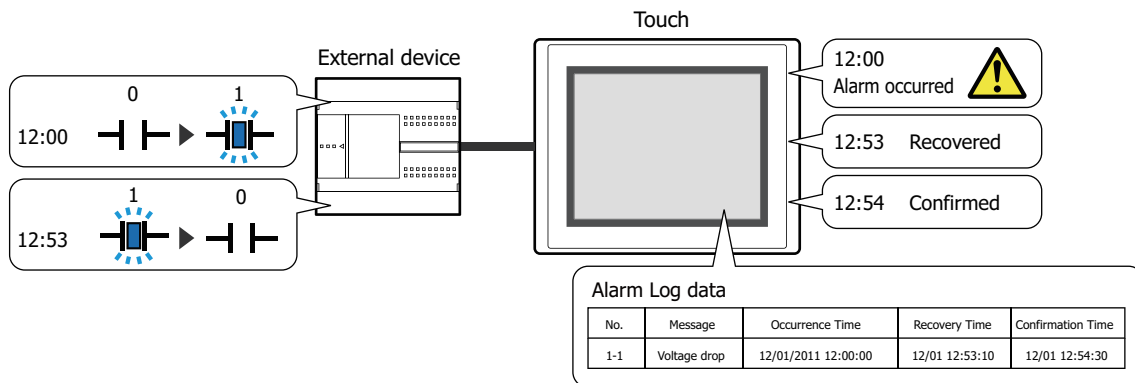

If the number of active alarms exceeds the Alarm Log data storage amount set for the data storage area, the data is processed with either of the following methods.

■ Fixed

If the saved data exceeds the Alarm Log data storage amount, the new data is not saved.

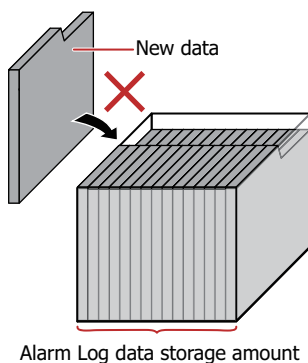

■ Rotate

If the saved data exceeds the Alarm Log data storage amount, the oldest data is deleted and the new data is saved.

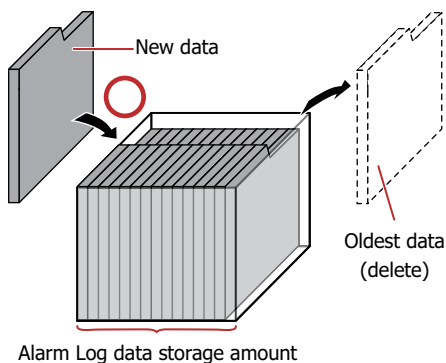

When the backup battery is depleted, the data in the Alarm Log is erased when the Touch is turned off.

Data Storage Amount

The maximum amount of data that can be saved in the data storage area is 5011.

When Not Saving Data to the Data Storage Area

Select **No Store** under **Data** in the Auto-Setup dialog box or in the Individual Settings dialog box.

Use this option to monitor a device state and display only detected active alarms on the Alarm List Display.

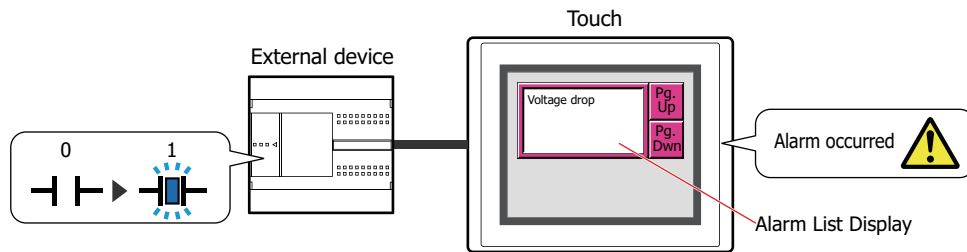

● Deleting Data

The method to delete sampled data from the data storage area is as follows.

- On the **Online** tab in WindO/I-NV3, click the arrow under **Clear**, and then click **All** or **Alarm Log Data**. For details, refer to Chapter 23 "4 Clear" on page 23-22.
- On the Top Page in the System Mode, press **Main Menu**, **Initial Setting**, **Initialize**, and **Alarm Log** in order.

1.6 Using Data and Detected Alarms

The saved data and detected alarms can be used in the following ways.

● Using Saved Data

The saved data can be used in the following ways.

Alarm Log data

Ch.No.	Message	Occurrence Time	Recovery Time	Confirmation Time
1-1	Voltage drop	12/01/2011 12:00:05	12/01 12:01:10	12/01 12:01:30
1-2	Temperature abnormal	12/01/2011 12:01:09	12/01 12:02:21	12/01 12:02:55
1-1	Voltage drop	12/01/2011 12:02:00	12/01 12:03:11	12/01 12:05:12
1-3	Overcurrent	12/01/2011 12:30:21	12/01 12:55:15	12/01 13:00:00
1-1	Voltage drop	12/01/2011 12:45:36	12/01 12:53:12	12/01 12:57:41

To use with the Touch

To use with devices other than the Touch

- Display data with the Alarm Log Display
Display Alarm Log data with the Alarm Log Display. For details, refer to Chapter 9 “7 Alarm Log Display” on page 9-99.

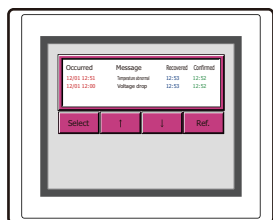

- Save to and read from an external memory
Alarm Log data is saved in a CSV file format into the external memory which it can be read on your computer. For details, refer to “4.4 Saving Data as a CSV File” on page 13-32.

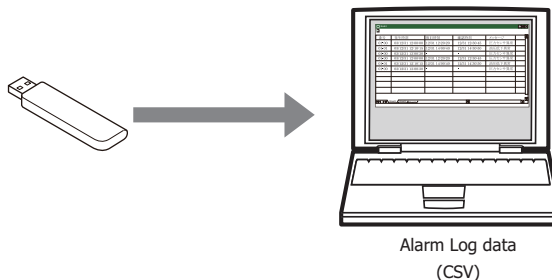

● Using Detected Alarms

- Display alarms with the Alarm List Display
Display detected alarms with the Alarm List Display. For details, refer to “4.2 Displaying Registered Messages with the Alarm List Display According to the Active Alarm” on page 13-27.

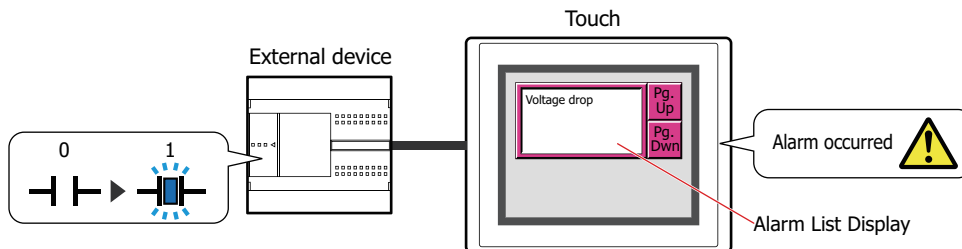

2 Alarm Log Function Configuration Procedure

This section describes the configuration procedure for the Alarm Log function.

2.1 Configuring the Devices to Monitor and the Alarm Detection Condition

- 1 On the **Configuration** tab, in the **System Setup** group, click **Alarm Log**.

The Alarm Log Settings dialog box is displayed.

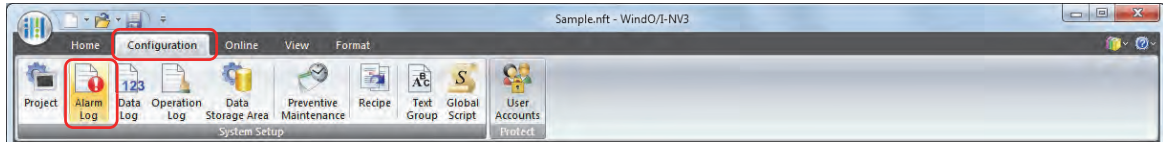

- 2 Select the type of device to monitor under **Source Device Type** on the **Channel** tab.

If you select **Word**, devices are configured per block.

If you select **Bit**, devices are configured per channel.

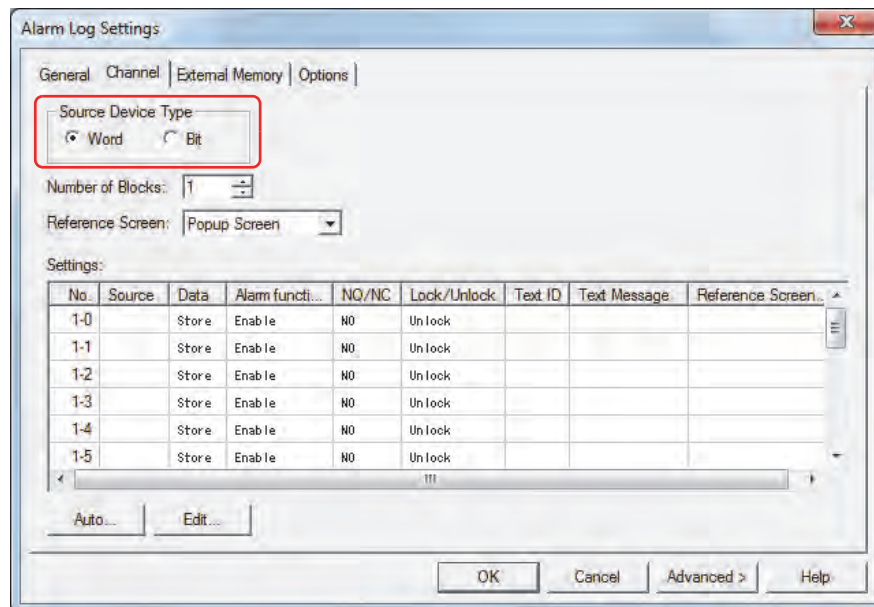

- 3 Set the number of blocks to manage in **Number of Blocks**.

One channel is used for one device to monitor. One block is 16 channels.

The number of blocks that can be set varies based on the **Source Device Type** setting.

- 4 Select the reference screen type in **Reference Screen**.

The reference screen is associated with the channel. This screen is displayed when the key button **Ref.** is pressed.

If a reference screen is not displayed, select **Not Use**.

- 5 To batch register all channels, click **Auto**. To individually register each channel, click **Edit**.

An example when **Auto** is clicked is described here.

The Auto-Setup dialog box is displayed.

6 Specify the device to monitor in **Source**.

Click  to display the Device Address Settings dialog box. For the device address configuration procedure, refer to Chapter 2 “5.1 Device Address Settings” on page 2-61.

For the Auto-Setup dialog box, the device addresses are sequentially set starting with the specified device address from the highlighted row in **Settings**.

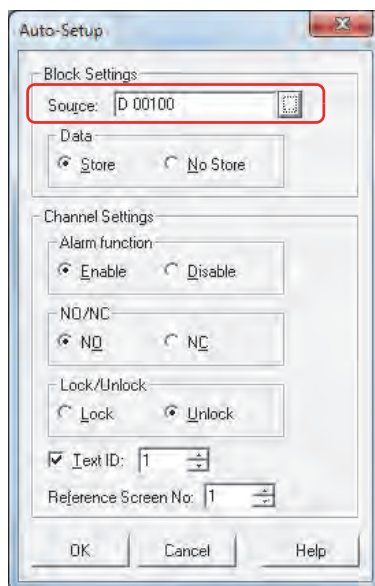

7 Under **Data**, select whether or not to save Alarm Log data in the date storage area.

To display Alarm Log data on the Touch or to output the data to a file, select **Store**.

If you select **No Store**, Alarm Log data is not created, but device states are monitored.

8 Under **Alarm function**, select whether or not to use the alarm function.

For channels with **Disable** selected, device states are not monitored and Alarm Log data is not created.

9 Under **NO/NC**, select the alarm detection condition.

If you select **NO**, the alarm occurs when the monitored bit changes from 0 to 1. If you select **NC**, the alarm occurs when the monitored bit changes from 1 to 0.

10 Under **Lock/Unlock**, select whether or not to automatically recover based on the state of the monitored bit.

If you select **Unlock**, the alarm is automatically recovered from based on the bit state when the monitored bit becomes the normal state.

If you select **Lock**, even if the monitored bit becomes the normal state, the alarm remains active until the key button **CHECK** is pressed.

11 Select the **Text ID** check box and specify the message to display when the alarm occurs as a Text Manager ID number (1 to 32000).

Number of blocks x 16 (number of channels) text IDs are used starting from the set ID number.

12 Specify the screen number (1 to 3000) to display when the key button **Ref.** is pressed in **Reference Screen No.**

Number of blocks x 16 (number of channels) screens are used starting from the screen number.

This option can only be configured when **Base Screen** or **Popup Screen** is selected in **Reference Screen**.

13 Click **OK**.

The devices to monitor and the messages are batch configured and displayed in **Settings** of Alarm Log Settings dialog box.

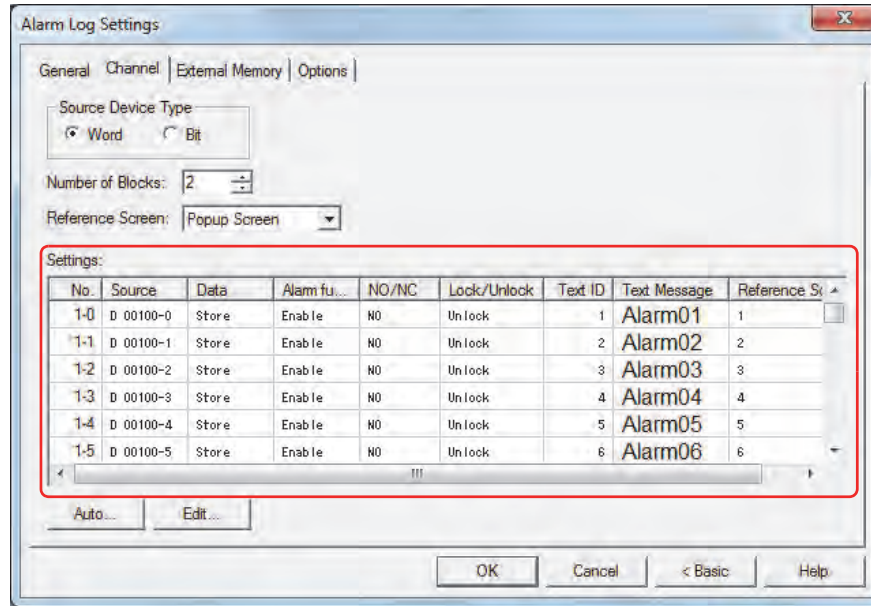

14 Click **OK**.

The Alarm Log Settings dialog box closes.

This concludes configuring the devices to monitor and the alarm detection condition.

Next, configure the functions to execute using saved data and detected alarms.

☞ "4.1 Displaying Saved Data with the Alarm Log Display" on page 13-25

☞ "4.2 Displaying Registered Messages with the Alarm List Display According to the Active Alarm" on page 13-27

☞ "4.3 Make a Sound of the Buzzer and Flash the Screen when an Alarm has Occurred" on page 13-30

☞ "4.4 Saving Data as a CSV File" on page 13-32

3 Alarm Log Settings Dialog Box

This section describes items and buttons on the Alarm Log Settings dialog box.

3.1 Alarm Log Settings Dialog Box

● General Tab

The **General** tab is used to configure what kind of data to sample when an alarm occurs and the methods for saving and deleting the sampled data.

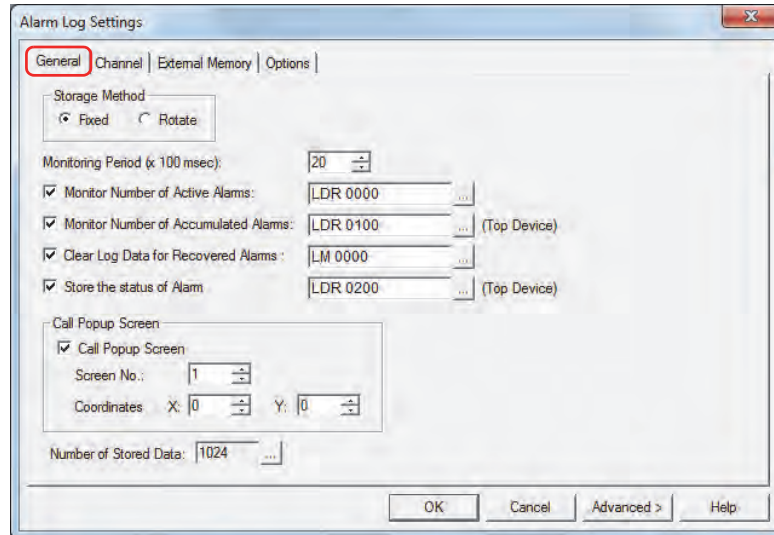

■ Storage Method

Selects the data processing method when the number of active alarms exceeds the Alarm Log data storage amount set for the data storage area.

Fixed: If the saved data exceeds the Alarm Log data storage amount, the new data is not saved.

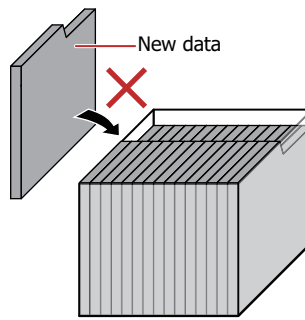

Alarm Log data storage amount

Rotate: If the saved data exceeds the Alarm Log data storage amount, the oldest data is deleted and the new data is saved.

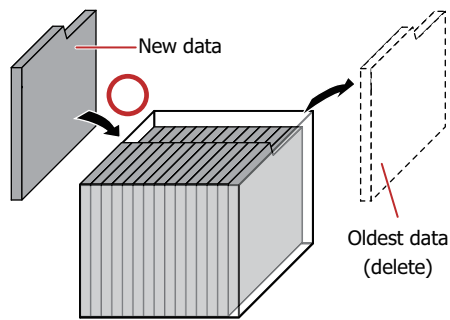

Alarm Log data storage amount

■ Monitoring Period (x 100 msec)

Specifies the period to write the state of the monitored device to the Touch (6 to 500 (100 milliseconds units)).

■ Monitor Number of Active Alarms

Select this check box to count the number of active alarms.

(Destination Device): Specifies a word device to write the number of active alarms.

For the device address configuration procedure, refer to Chapter 2 “5.1 Device Address Settings” on page 2-61.

■ Monitor How Many Times Each Alarm has occurred

Select this check box to count the number of alarms that has occurred per channel.

(Top Device): Specifies a word device to write the number of alarms that has occurred. Number of blocks x 16 (number of channels) addresses are used starting from the set device address.

For the device address configuration procedure, refer to Chapter 2 “5.1 Device Address Settings” on page 2-61.

Example: When the number of blocks is 2 and LKR100 is specified as the starting device

The number of alarms that has occurred for channel number 1-0 is saved in LKR100.

The number of alarms that has occurred for channel 1-1 is saved in LKR101, and this

pattern continues up to LKR131 where the number of alarms that has occurred for

channel number 2-15 is saved.

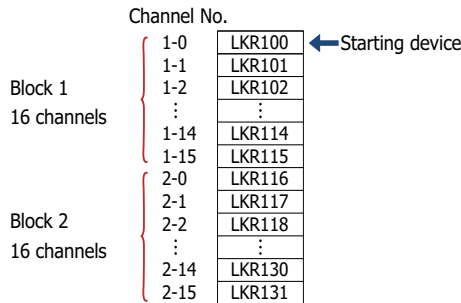

- If you specify HMI Keep Registers (LKR) as the destination word device, the number of alarms that has occurred is retained even when the Touch power is turned off.
- The amount of Alarm Log data saved in the data storage area with the Alarm Log function is stored in HMI Special Data Register LSD57.



- To monitor the number of alarms that has occurred, number of blocks x 16 (number of channels) devices are required from the set starting device. If the destination device does not exist, “Device range error” occurs on the Touch.
- If the values of devices that are counting the number of alarms that has occurred are overwritten by another process, the alarms cannot be accurately counted.

■ Clear Log Data for Recovered Alarms

Select this check box to delete recovered data out of the saved Alarm Log data.

(Trigger Device): Specifies the bit device or bit of the word device to serve as condition to delete data. The recovered data is deleted when the value of the configured device changes from 0 to 1. For the device address configuration procedure, refer to Chapter 2 “5.1 Device Address Settings” on page 2-61.

■ Monitor the State of Each Alarm

Select this check box to check the alarm state per channel.

(Top Device): Specifies a word device to write the alarm state. Number of blocks x 16 (number of channels) addresses are used starting from the set device address.

For the device address configuration procedure, refer to Chapter 2 “5.1 Device Address Settings” on page 2-61.

The following values are written to the bits depending on the alarm state.

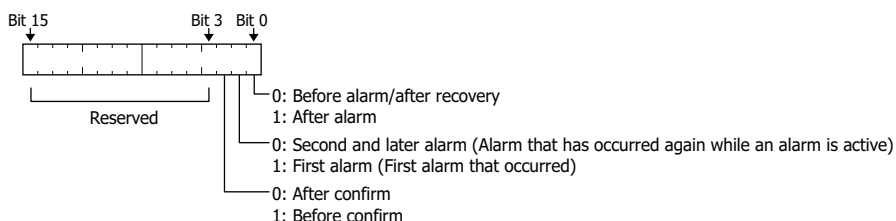

■ Call Popup Screen

These settings configure the Popup Screen to display when an alarm occurs. The Popup Screen displayed when an alarm occurs is called the alarm screen.

Call Popup Screen:	Select this check box to display the alarm screen when an alarm occurs.
Screen No.:	Specifies the alarm screen number (1 to 3015) to display when an alarm occurs.
Coordinates X, Y:	Specifies the coordinates to display the alarm screen. With the upper-left corner of the screen as the origin, the upper-left corner of the alarm screen is the X and Y coordinates. Specify the coordinates in 1 dot units. X: 0 to (Base Screen horizontal size - 1) Y: 0 to (Base Screen vertical size - 1)

■ Number of Stored Data

Specifies the maximum amount of Alarm Log data saved in the data storage area. Data is saved up to the set amount. The maximum amount of data that can be saved in the data storage area is 5011.

Click  to open the Data Storage Area Management dialog box. You can change the allocation of data storage area memory in the Data Storage Area Management dialog box. For details, refer to Chapter 16 "Data Storage Area" on page 16-1.

● **Channel Tab**

The **Channel** tab is used to configure the devices to monitor and the alarm detection condition.

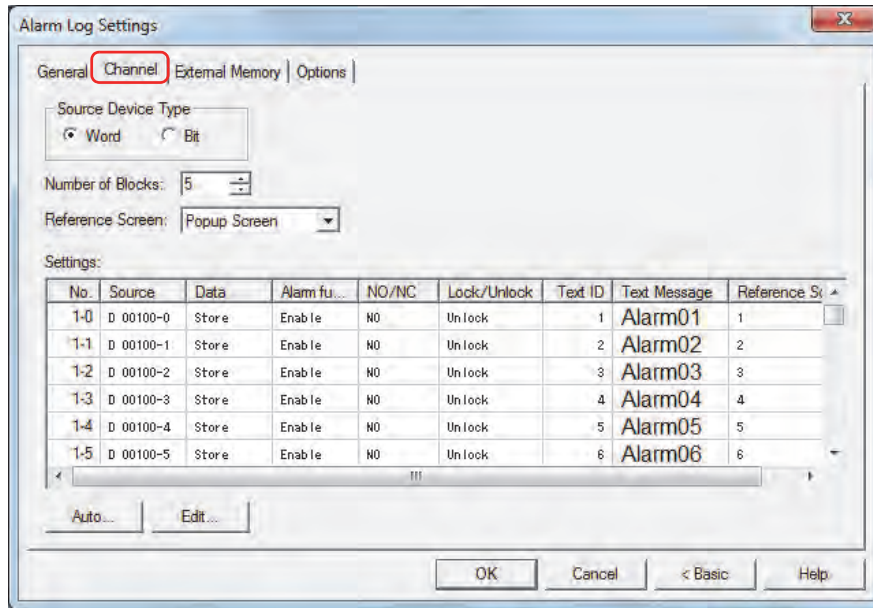

■ **Source Device Type**

Selects the type of device to monitor.

Word: Uses a word device. Devices are configured per block.

Bit: Uses a bit device. Devices are configured per channel.

■ **Number of Blocks**

Configures the Alarm Log data in block units. The number of blocks that can be set varies based on the **Source Device Type** setting and the Touch model.

Word: 0 to 128

Bit: 0 to 8



One block is composed of 16 channels. One device can be monitored for each channel. The maximum number of devices that can be monitored is 16 for each block.

■ **Reference Screen**

Select the type of reference screen from the following items.

Base Screen, Popup Screen, Not Use

The reference screen is displayed when a message is selected on the Alarm List Display or the Alarm Log Display and the key button **Ref.** is pressed. It is the Base Screen or Popup Screen associated with each channel.

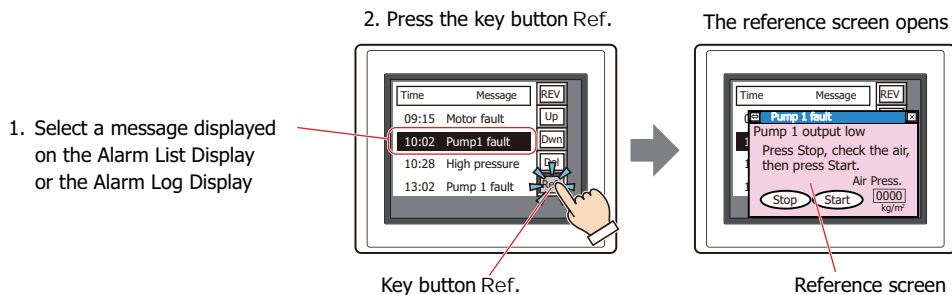

■ Settings

The Alarm Log settings for each channel are edited here.

No.:	Displayed as (Block No.)-(Channel No.). Double clicking the cell opens the Individual Settings dialog box.
Source:	Shows the bit device or bit of the word device to monitor. Double clicking the cell opens the Device Address Settings dialog box. For the device address configuration procedure, refer to Chapter 2 "5.1 Device Address Settings" on page 2-61.
Data:	Shows whether or not to save Alarm Log data in the data storage area. Double clicking the cell switches between Store and No Store .
Alarm function:	Shows whether or not the alarm function is used. Double clicking the cell switches between Enable and Disable . Channels switched to Disable cannot be configured. Device states are not monitored and Alarm Log data is not created.
NO/NC:	Shows the alarm detection condition. Double clicking the cell switches between NO and NC .
Lock/Unlock:	Shows whether or not to automatically recover based on the state of the monitored bit. Double clicking the cell switches between Lock and Unlock .
Text ID:	Shows the Text Manager ID number (1 to 32000) to use for the message displayed when an alarm occurs. Double clicking the cell allows you to specify the Text Manager ID number.
Text Message:	Shows the text for the specified text ID. Double clicking the cell opens Text Manager.
Reference Screen No.:	Shows the screen number to display when the key button Ref. is pressed. Double clicking the cell opens the Individual Settings dialog box. This option can only be configured when Base Screen or Popup Screen is selected in Reference Screen .

■ Auto

Batch registers or changes the settings for all the channels.

Click this button to open the Auto-Setup dialog box. The Auto-Setup dialog box settings are reflected in all the channels.

For details, refer to "Auto-Setup Dialog Box and Individual Settings Dialog Box" on page 13-18.

■ Edit

Registers or changes, the settings for the selected channel.

Select a channel, and then click this button to open the Individual Settings dialog box. The settings for the selected channel are reflected in the Individual Settings dialog box.

For details, refer to "Auto-Setup Dialog Box and Individual Settings Dialog Box" on page 13-18.

Auto-Setup Dialog Box and Individual Settings Dialog Box

With the Auto-Setup dialog box, the Alarm Log settings for all channels are batch registered or changed.

With the Individual Settings dialog box, the Alarm Log settings for the selected channel are registered or changed.

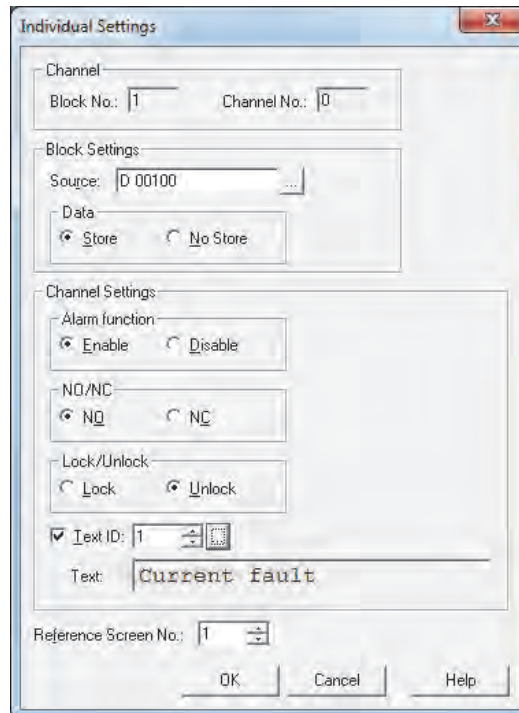

■ Channel*1

Shows the block number and the channel number for the selected channel.

Block No.: Shows the block number for the channel selected in **Settings**.

Channel No.: Shows the channel number for the channel selected in **Settings**.

■ Block Settings

Configures **Source** and **Data** in block units.

Source: For the Auto-Setup dialog box, the device addresses are sequentially set from block number 1-channel number 1, starting with the specified device address.

For the Individual Settings dialog box, if **Source Device Type** on the **Channel** tab is **Word**, the 16 channels for the block selected at the start of the specified device address are batch configured. For **Bit**, the selected channel is individually configured.

Click **...** to open the Device Address Settings dialog box where you can edit the device address. For the device address configuration procedure, refer to Chapter 2 "5.1 Device Address Settings" on page 2-61.

Data: Selects whether or not to save Alarm Log data in the date storage area.

For the Auto-Setup dialog box, all the channels are batch configured.

For the Individual Settings dialog box, the 16 channels for the selected block are batch configured.

Store: Alarm Log data can be displayed on the Touch or output to file.

No Store: Alarm Log data is not created, but device states are monitored.

*1 Individual Settings dialog box only

■ Channel Settings

The trigger condition for the channel is configured here.

- Alarm function: Selects whether or not to use the alarm function.
- Enable: Monitors the state of the device configured for the channel and samples the alarm information.
- Disable: Does not monitor the state of the device. No Alarm Log data is created.
- NO/NC: Selects the alarm detection condition.
- NO: The alarm occurs when the monitored bit changes from 0 to 1.
- NC: The alarm occurs when the monitored bit changes from 1 to 0.
- Lock/Unlock: Selects whether or not to automatically recover based on the state of the monitored bit.
- Lock: Even if the monitored bit returns the normal state, the alarm remains active until the key button **CHECK** is pressed.
- Unlock: The alarm is automatically recovered from based on the bit state when the monitored bit returns the normal state.

Example: When **NO/NC** is **NO**

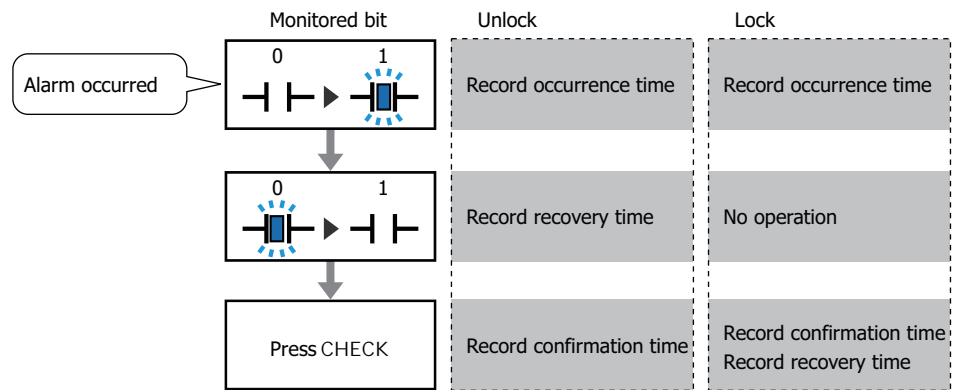

The display on the Alarm List Display disappears when the alarm is recovered from, regardless of the **Lock/Unlock** setting. To keep displaying the alarm until **CHECK** is pressed, use the Alarm Log Display.

- Text ID: To use text registered in Text Manager as the message to display when an alarm occurs, select this check box and specify the Text Manager ID number to use as the message. Number of blocks x 16 (number of channels) text IDs are used starting from the set ID number.
- Click to open Text Manager where you can edit the text.
- Text: Shows the text for the specified text ID.
- Reference Screen No.: Specifies the screen number (1 to 3000) to display when the key button **Ref.** is pressed. Number of blocks x 16 (number of channels) screens are used starting from the screen number.
- This option can only be configured when **Base Screen** or **Popup Screen** is selected in **Reference Screen**.

● External Memory Tab

The **External Memory** tab is used to configure whether or not to output saved data to the external memory.

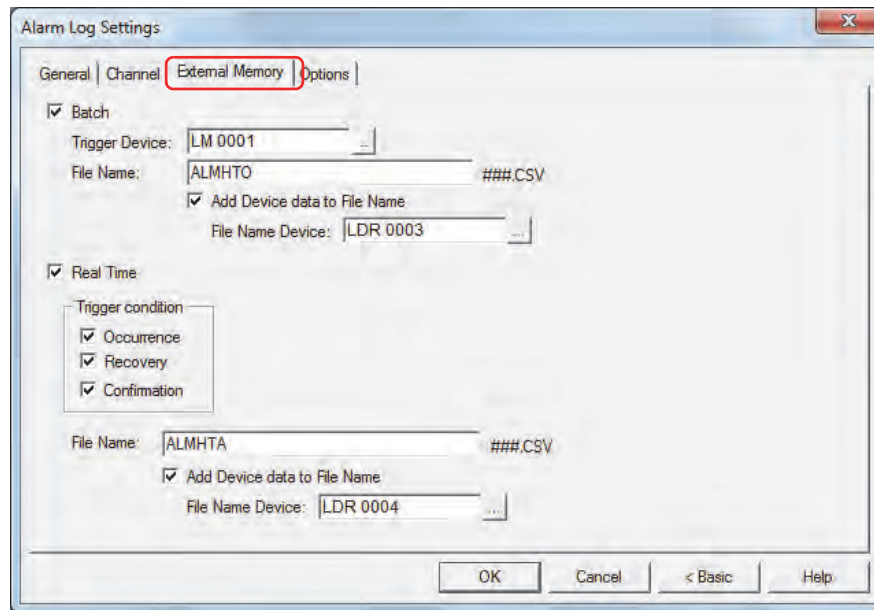

The output data is stored in the following folder on the external memory.

External memory folder\ALARMLOG

The default External Memory Folder name is "HGDATA01". For details, refer to Chapter 26 "1.5 Setting the External Memory Folder" on page 26-12.



Sampled data after starting output to the external memory is not included in the output data.

■ Batch

Select this check box to batch output all the sampled data to the external memory.

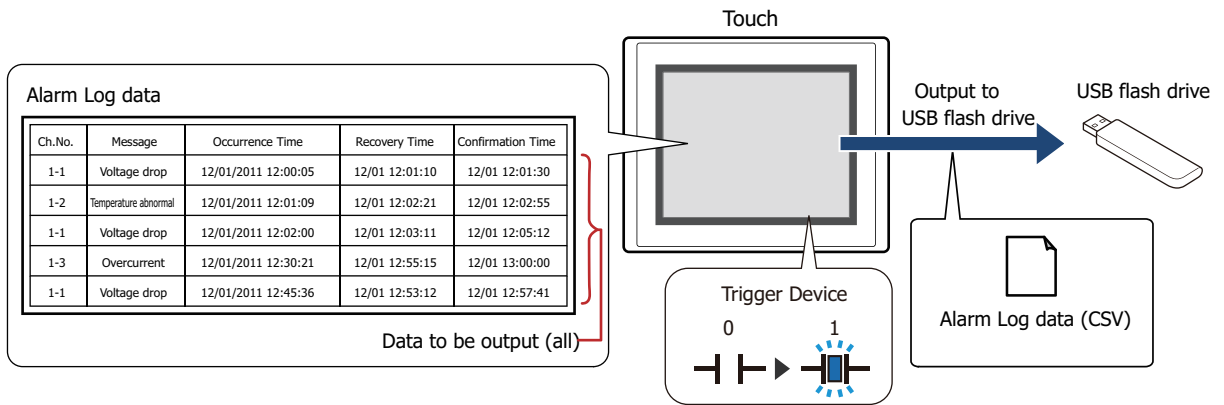

All the data is saved on the external memory when the trigger devices changes from 0 to 1. If a file with the same name already exists on the external memory, that file is overwritten. The maximum amount of output data is the amount configured by the data storage area.



Output stops if there is insufficient free space on the external memory. USB flash drive error information is stored in HMI Special Data Register LSD33.

Trigger Device: Specifies the bit device or bit of the word device to serve as condition for batch output. For the device address configuration procedure, refer to Chapter 2 "5.1 Device Address Settings" on page 2-61.

Data is output to file when the trigger device changes from 0 to 1.

File Name: Enter the file name for the output data or shows the file name.

The default is "ALMHTO.CSV". To change the file name, enter a new file name. The maximum number is 120 characters (including the extension).

Add Device data to File Name*1:

Select this check box to add the bottom three digits of the value of device configured by **File Name Device** to the end of the file name for the output data.

Example: When the value of device configured by **File Name Device** is 123, the file name is "ALMHTO123.CSV".

File Name Device:

Specifies the word device that is the source for the value to add to the file name. For the device address configuration procedure, refer to Chapter 2 "5.1 Device Address Settings" on page 2-61. This option can only be configured when the **Add Device data to File Name** check box is selected.

*1 Advanced mode only

■ Real Time

Select this check box to output data to the external memory in real time.

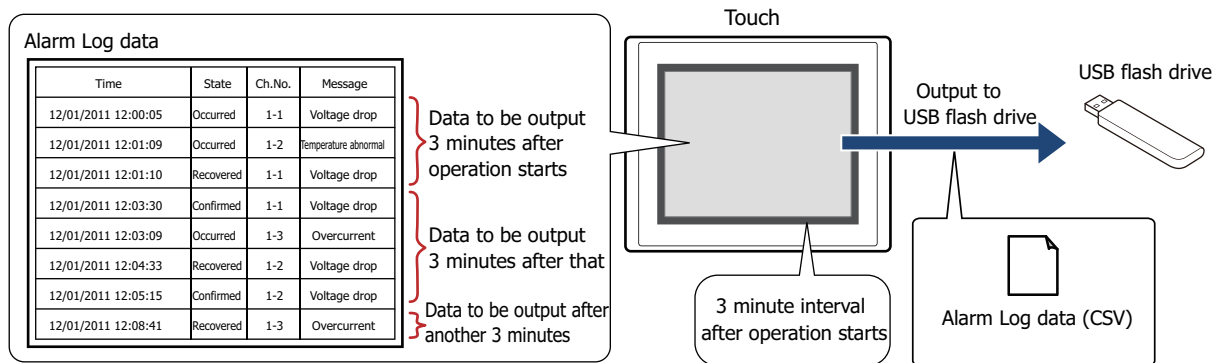

With real time output, data is saved to the external memory in three minute intervals after the Touch starts running. When there is already data with the same file name on the external memory, data is appended to that file. If there was no update to the data during the three minutes, it is not output.

Data is appended to the file until the size of the file reaches the restriction size (256 MB), so the maximum amount of output data varies based on the settings for the output channel such as the amount of data, the data size, and the labels.

If the interval to update the Alarm Log is shorter than real time output (the interval for writing to the external memory), that Alarm Log is recorded up to the 1,023rd item, and then afterwards, old data is discarded in order and replaced with new data.



Real time output stops when the file size of the Alarm Log data exceeds 256 MB or when there is insufficient space on the external memory. USB flash drive error information is stored in HMI Special Data Register LSD33.



- When the value of HMI Special Relay LSM18 changes from 0 to 1, the data at that time is first output in real time to the USB flash drive, and then access to the USB flash drive is stopped.
- You can check the free space on the USB flash drive with HMI Special Data Register LSD34 to 35.

Trigger condition: Select the check boxes for the items that will trigger the output of Alarm Log data to the external memory.

Occurrence: Alarm Log data is output to the external memory when an alarm has occurred.

Recovery: Alarm Log data is output to the external memory when the alarm is recovered from.

Confirmation: Alarm Log data is output to the external memory when the key button **CHECK** was pressed.



Month/day/year hour:minute:second is output for the trigger condition occurrence time, recovery time, and confirmation time.

File Name: Enter the file name for the output data or shows the file name.

The default is "ALMHTA.CSV". To change the file name, enter a new file name. The maximum number is 120 characters (including the extension).

Add Device data to File Name*¹: Select this check box to add the bottom three digits of the value of device configured by **File Name Device** to the end of the file name for the output data.

Example: When the value of device configured by **File Name Device** is 123, the file name is "ALMHTA123.CSV".

File Name Device: Specifies the word device that is the source for the value to add to the file name. For the device address configuration procedure, refer to Chapter 2 "5.1 Device Address Settings" on page 2-61. This option can only be configured when the **Add Device data to File Name** check box is selected.

*1 Advanced mode only



- The function to sample data operates when Alarm Log data is being saved to the external memory.
- The methods to erase Alarm Log files saved on the external memory are as follows.
 - To erase files during operation using parts, on the **External Memory** tab on the Project Settings dialog box, select the **Remove Files stored in External Memory** check box and the **All Alarm Log data** check box, and then configure the trigger device. Assign that trigger device to a part.
 - To erase files with WindO/I-NV3, click **Clear** on the **Online** tab, and then click **Stored Data in External Memory** to open the Clear Data dialog box. Select the **Alarm Log Data** check box, and then click **OK**.

● Options Tab

The **Options** tab is used to configure whether or not the Touch's internal buzzer operates and the screen flashing.

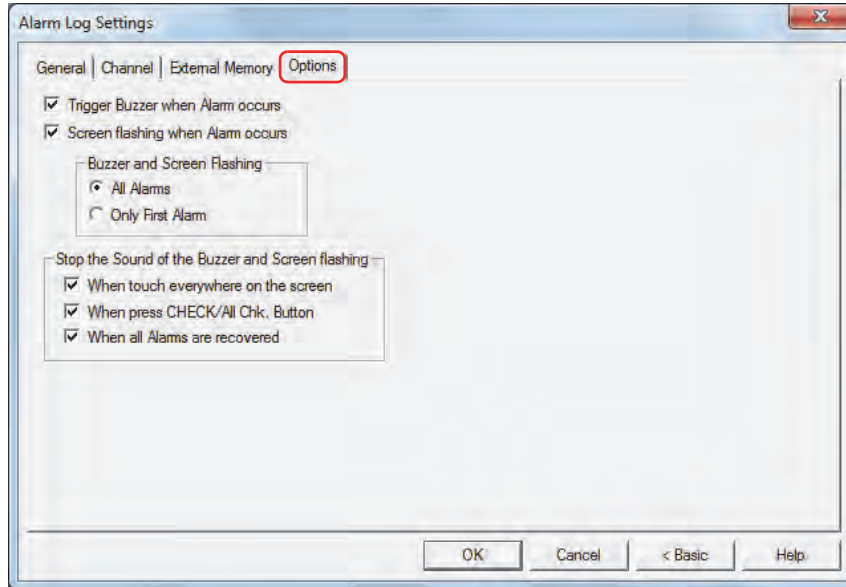

■ Trigger Buzzer when Alarm occurs

Select this check box to make a sound of the buzzer when an alarm has occurred.

■ Screen flashing when Alarm occurs

Select this check box to have the screen flash when an alarm occurs.

For monochrome LCD models, the backlight changes to red while the screen is flashing.

■ Buzzer and Screen Flashing^{*1}

This item selects the condition for the alarm to sound the buzzer or to flash the screen. This item can only be configured when the **Buzzer when Alarm occurs** or the **Screen flashing when Alarms occurs** is selected.

All Alarms: The buzzer is triggered and the screen flashing each time an alarm occur.

Only First Alarm: The buzzer is triggered and the screen flashing only when the first alarm^{*2} occurs. No beeps will sound and no screen will flash when another alarm is already active.

■ Stop the Sound of the Buzzer and Screen flashing^{*1}

Select the check box for the items that will trigger the sound of the buzzer and screen flashing to stop.

When touch everywhere on the screen: The sound of the buzzer and screen flashing stops when you touch anywhere on the screen.

When press CHECK/All Chk. button: The sound of the buzzer and screen flashing stops when you touch the key buttons **CHECK** or **All Chk.** on the Alarm Log Display.

When all Alarms are recovered: The sound of the buzzer and screen flashing stops when all the alarms are recovered from.



- While the sound of the buzzer is sounding, System Area 1 (address+1, bit 6) is 1.
 - While the screen is flashing, System Area 1 (address+1, bit 2) is 1.
For monochrome LCD models, System Area 1 (address+1, bit 3) is 0 and System Area 1 (address+1, bit 4) is 1 while the screen flashing.
 - To stop the sound of the buzzer and the screen flashing when an alarm has occurred, use the following methods.
 - Press the key button **Stop the Sound of the Buzzer and Screen flashing**
 - When a condition selected with the **Stop the Sound of the Buzzer and Screen flashing** check boxes is satisfied
 - To stop the sound of the buzzer, set System Area 1 (address+1, bit 6) to 0
 - To stop the screen flashing, set System Area 1 (address+1, bit 1 to 4) to 0
- However, when System Area 1 (address+1, bit 6) is 1 for a reason other than the occurrence of an alarm, the sound of the buzzer does not stop until 0 is written. When System Area 1 (address+1, bit 1 to 4) are 1, the alarm is triggered, however, the screen flashing doesn't stop until 0 is written into it.
- If you stop the screen flashing, the backlight turns off when System Area 1 (address+1, bit 0), and the backlight turns on when it is 1.

*1 Advanced mode only

*2 The first alarm that has occurred in a state where no alarms are active

4 Using Data and Detected Alarms

4.1 Displaying Saved Data with the Alarm Log Display

- 1 On the **Configuration** tab, in the **System Setup** group, click **Alarm Log**.

The Alarm Log Settings dialog box is displayed.

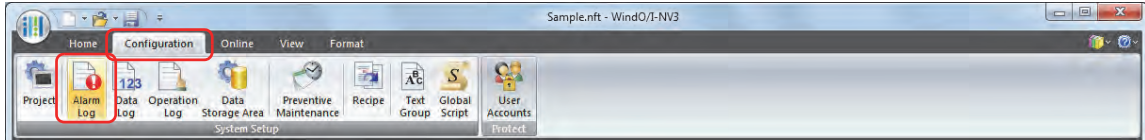

- 2 Select the type of device to monitor under **Source Device Type** on the **Channel** tab and specify **Number of Blocks**.

- 3 Select the channel number to register, and then click **Edit**.

The Individual Settings dialog box is displayed.

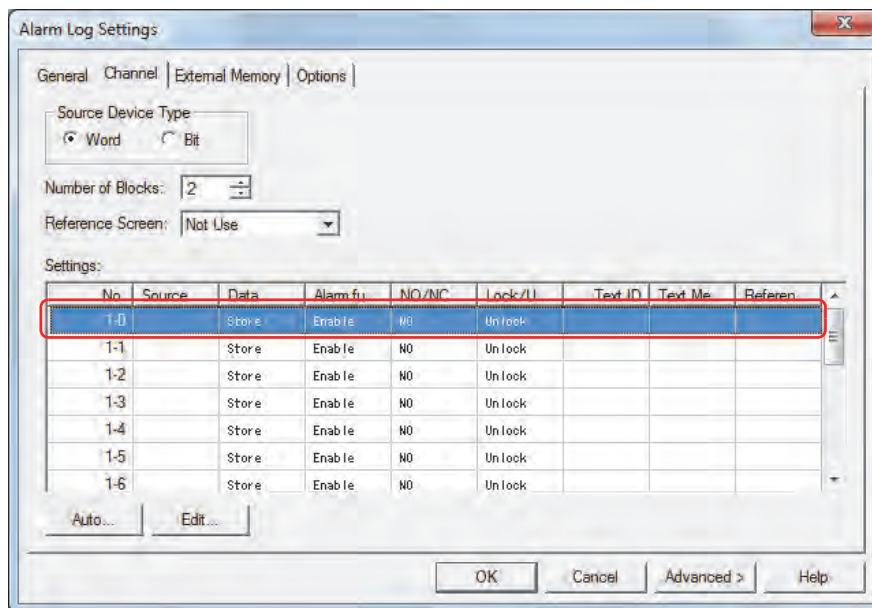

- 4 Specify the device to monitor in **Source** and select **Store** under **Data**.

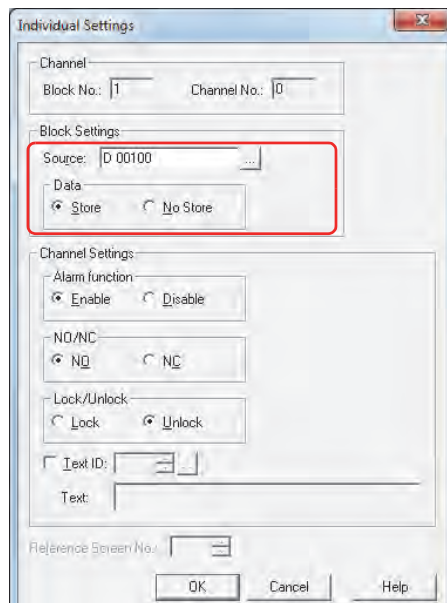

- 5 Select **Enable** under **Alarm function**, configure **NO/NC** and **Lock/Unlock**, and then click **OK**.
- 6 Repeat steps 3 through 5 to register all the channels.
- 7 Click **OK**.
The Alarm Log Settings dialog box closes.
- 8 On the **Home** tab, in the **Parts** group, click **Data Displays**, and then click **Alarm Log Display**.

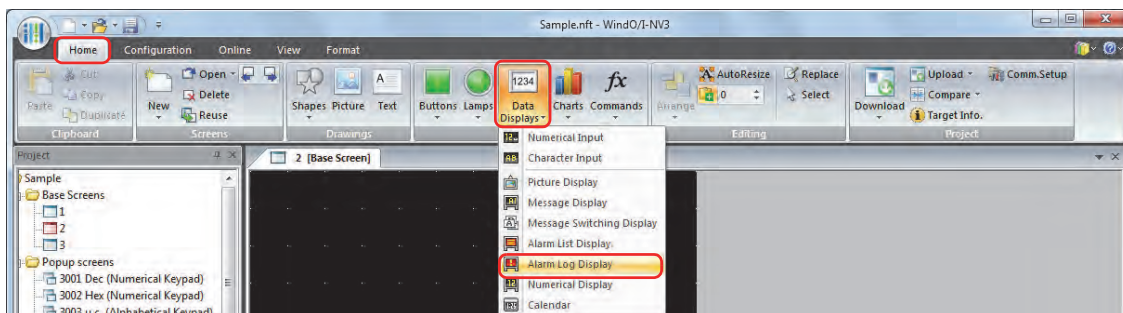

- 9 Click a point on the edit screen where you want to place the Alarm Log Display.
- 10 Double-click the dropped Alarm Log Display and a Properties dialog box will be displayed.

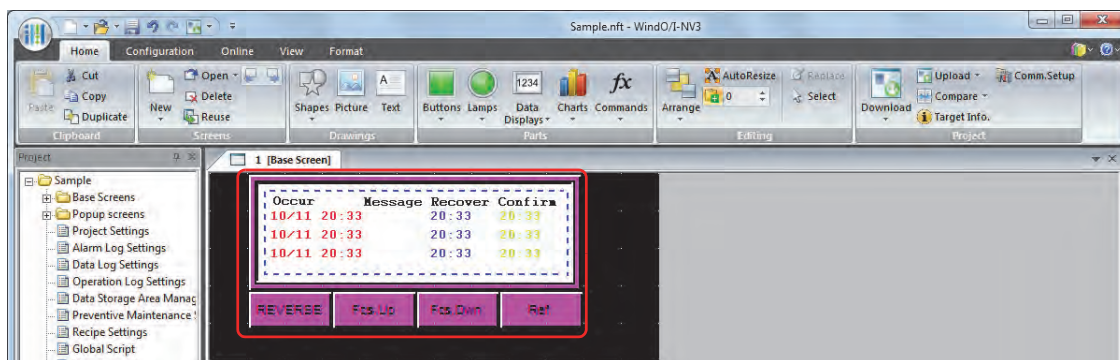

- 11 Change the settings on each tab as necessary.
For details, refer to Chapter 9 "7.3 Properties of Alarm Log Display Dialog Box" on page 9-101.

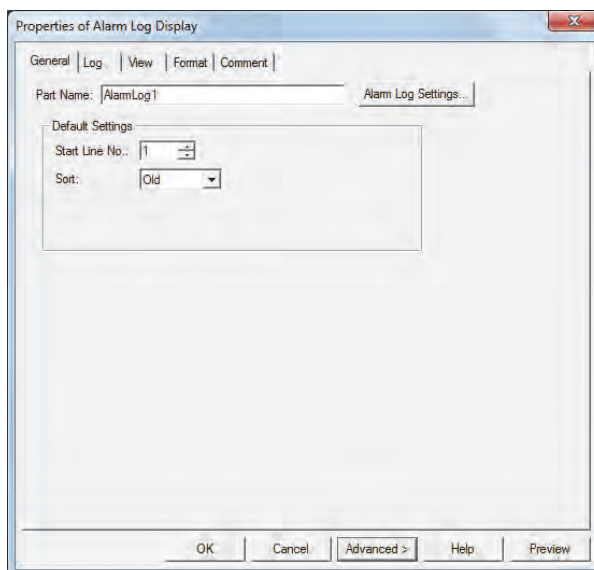

- 12 Click **OK**.
The Properties of Alarm Log Display dialog box closes.
This concludes configuring the Touch to display saved data with the Alarm Log Display.

4.2 Displaying Registered Messages with the Alarm List Display According to the Active Alarm

- 1 On the **Configuration** tab, in the **System Setup** group, click **Alarm Log**.
The Alarm Log Settings dialog box is displayed.

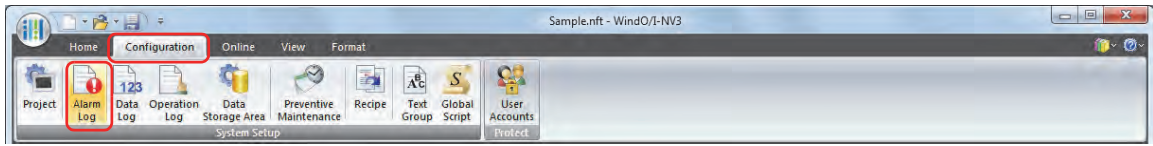

- 2 Select the type of device to monitor under **Source Device Type** on the **Channel** tab and specify **Number of Blocks**.
- 3 Select the channel number to register a message to, and then click **Edit**.
The Individual Settings dialog box is displayed.

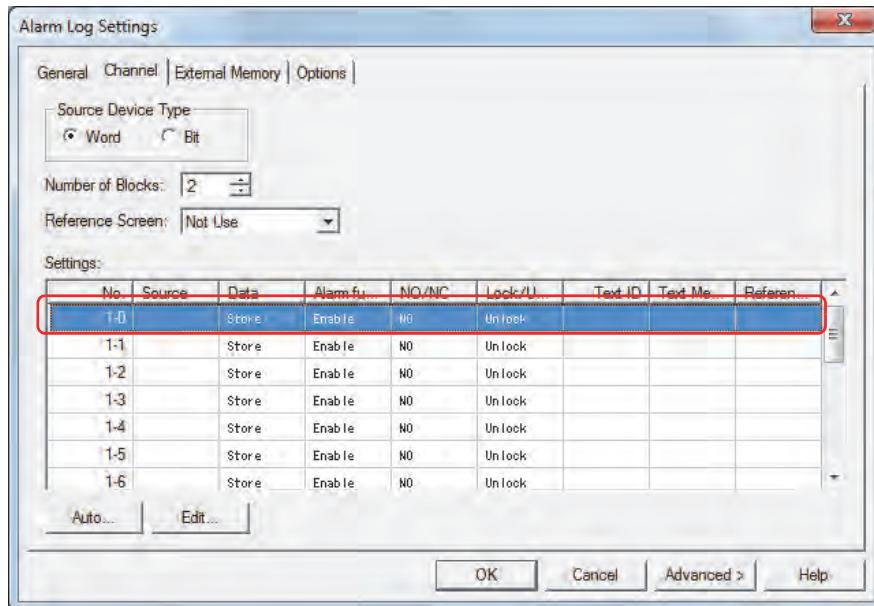

- 4 Specify the device to monitor in **Source** and select **No Store** under **Data**.

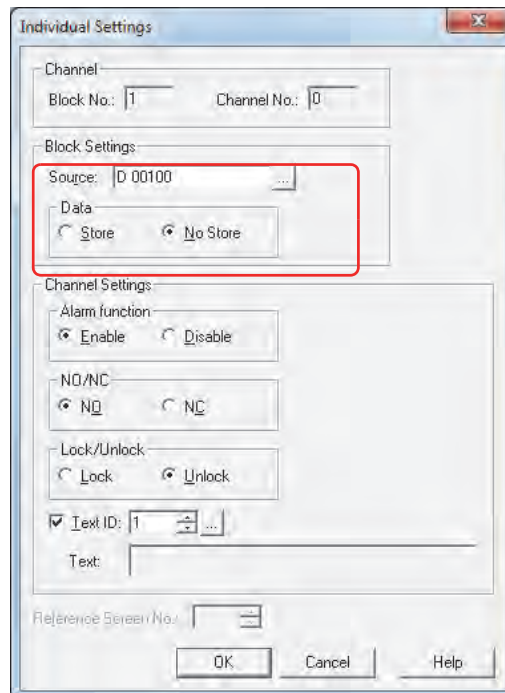

- 5 Select **Enable** under **Alarm function** and configure **NO/NC** and **Lock/Unlock**.
- 6 Select the **Text ID** check box, and then click **...**.
Text Manager opens.

- 7 Enter the message in **Text**.

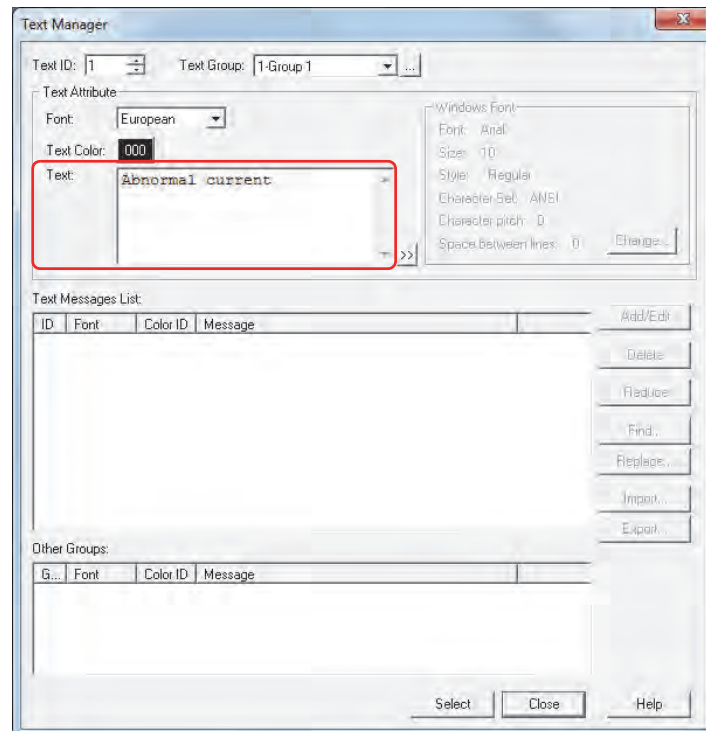

- 8 Click **Select**.

- 9 Click **OK** in the Individual Settings dialog box.

The registered message is displayed in **Settings** of the Alarm Log Settings dialog box.

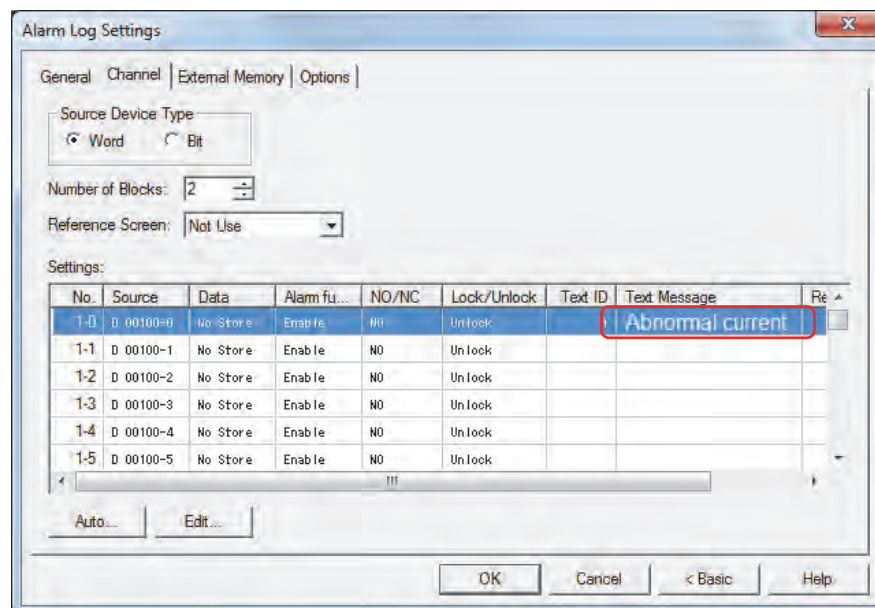

- 10 Repeat steps 3 through 9 to register messages for all the channels.



The messages to use can be registered in advance in Text Manager.

- 11 Click **OK**.

The Alarm Log Settings dialog box closes.

- 12 On the **Home** tab, in the **Parts** group, click **Data Displays**, and then click **Alarm List Display**.

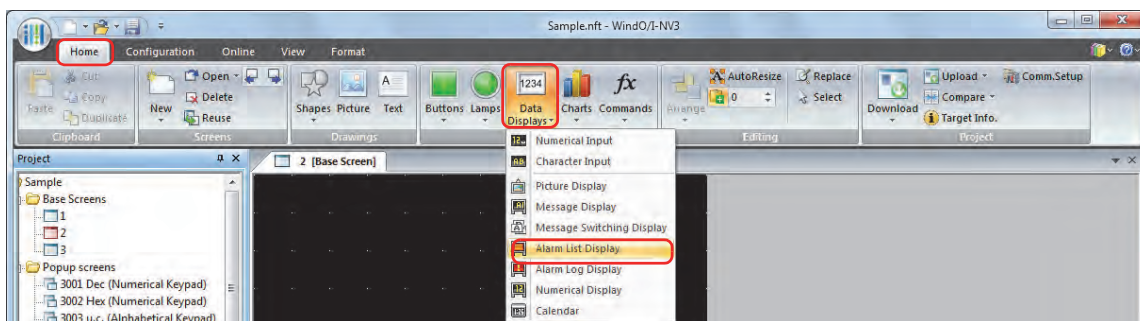

- 13 Click a point on the edit screen where you want to place the Alarm List Display.

- 14 Double-click the dropped Alarm List Display and a Properties dialog box will be displayed.

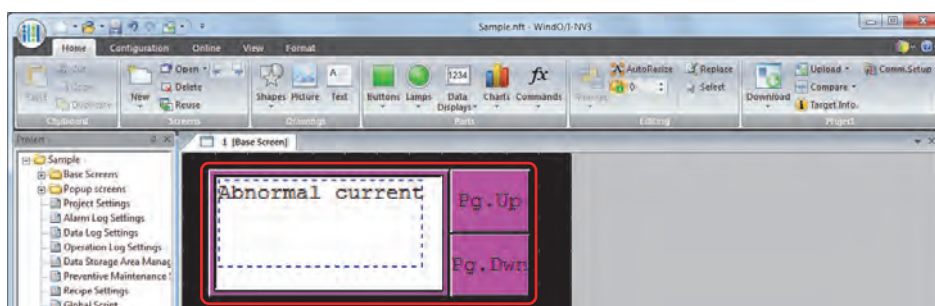

- 15 On the **General** tab, under **Message Settings**, select **Use Alarm Log Settings**.

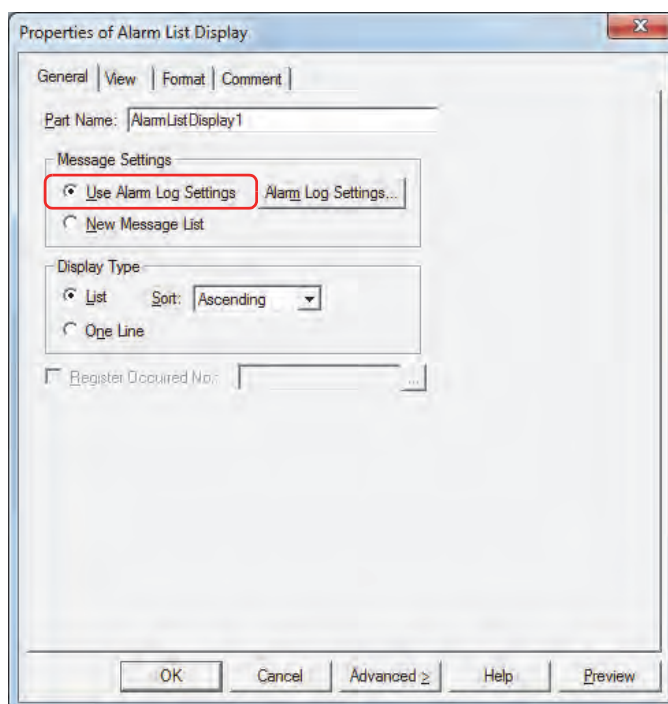

- 16 Configure the other settings and the settings on each tab as necessary.
For details, refer to Chapter 9 "6.3 Properties of Alarm List Display Dialog Box" on page 9-85.

- 17 Click **OK**.

The Properties of Alarm List Display dialog box closes.

This concludes configuring the Touch to display registered messages with the Alarm List Display according to the active alarm.

4.3 Make a Sound of the Buzzer and Flash the Screen when an Alarm has Occurred

- 1 On the **Configuration** tab, in the **System Setup** group, click **Alarm Log**.

The Alarm Log Settings dialog box is displayed.

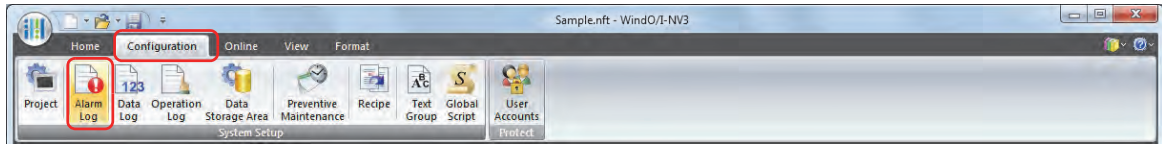

- 2 Select the type of device to monitor under **Source Device Type** on the **Channel** tab and specify **Number of Blocks**.
- 3 Select the channel number to register a message to, and then click **Edit**.

The Individual Settings dialog box is displayed.

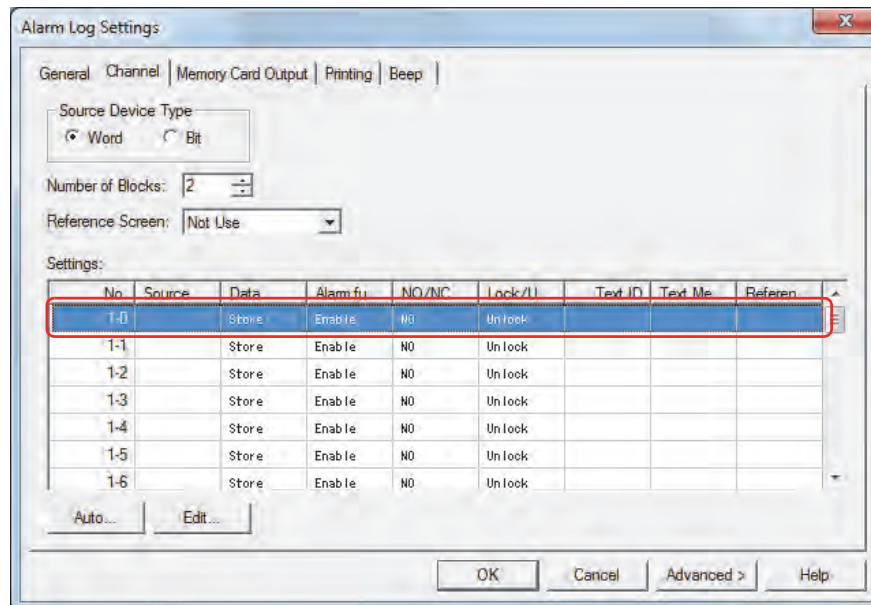

- 4 Specify the device to monitor in **Source** and select **Store** under **Data**.

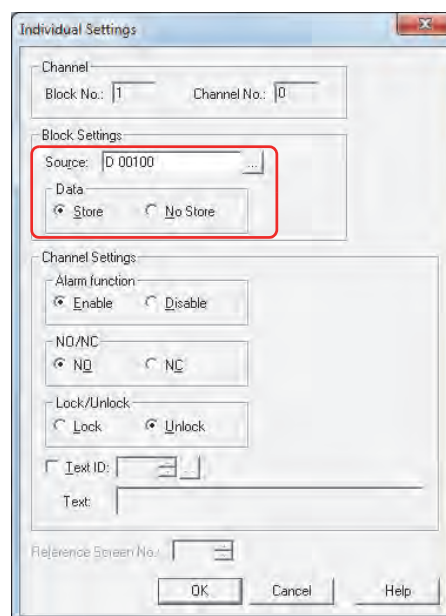

- 5 Select **Enable** under **Alarm function**, configure **NO/NC** and **Lock/Unlock**, and then click **OK**.

- 6 Click the **Options** tab in the Alarm Log Settings dialog box.

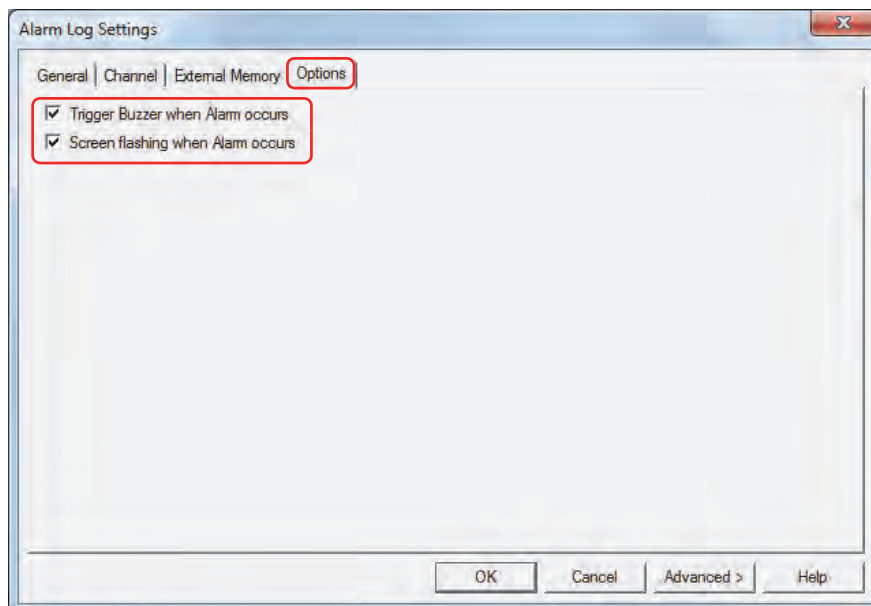

- 7 Select the **Trigger Buzzer when Alarm occurs** check box to make a sound of the buzzer when an alarm has occurred.
- 8 Select the **Screen flashing when Alarm occurs** check box to have the screen flashing when an alarm has occurred.
- 9 Click **OK**.

The Alarm Log Settings dialog box closes.

This concludes configuring the settings to make a sound of the buzzer and the screen flashing when an alarm has occurred.

4.4 Saving Data as a CSV File

● Saving Data as a CSV File

The Alarm Log data can be saved to the external memory as a CSV file.

The procedure to save the data is as follows.

On the WindO/I-NV3 **System Setup** tab, click **Alarm Log** to display the Alarm Log Settings dialog box. Select an output method check box on the **External Memory** tab and configure the items. The data can be saved to the External Memory Folder on the external memory. For details, refer to "External Memory Tab" on page 13-20.



Files saved to external memory are read using WindO/I-NV3.

On the WindO/I-NV3 **Online** tab, click the arrow under **Upload**, and then click **Data in external memory** to display the Upload from external memory dialog box. Select the **Alarm Log Data** check box, specify the location to save the files in **Path**, and then click **OK** to be able to save the files in the specified folder.

● Data Structure and Output Example

The data structure for files output with batch output and real time output is different.

■ Batch

Batch output shows the recovery and confirmation time for an alarm that has occurred on a single line.

The data structure of files output with batch output is as follows. Bold items are replaced by the Alarm Log settings, sampled data, project file name, and WindO/I-NV3 version.

Headers	"Project Name", " Project name ", " Version number "
	"File Type", " Log type "
	Blank row
Title row	"Ch.No.", "Message", "Occurrence Time", "Recovery Time", "Confirmation Time"
Data row	" Channel number ", " Message ", " MM/DD/YYYY HH:MM:SS", " MM/DD/YYYY HH:MM:SS", " MM/DD/YYYY HH:MM:SS "
	⋮

Output example

"Project Name", "Dimmer Console", "V1.00"	Data size of each row
"File Type", "Alarm Log Data"	- 41 bytes
	- 30 bytes
	- 2 bytes
"Ch.No.", "Message", "Occurrence Time", "Recovery Time", "Confirmation Time"	- 74 bytes
" 1-0", "Voltage drop", " 08/11/2011 14:46:12", " 08/11 14:46:13", " 08/11 14:46:16"	- 82 bytes
" 1-1", "Temperature abnormal", " 08/11/2011 14:47:18", " 08/11 14:47:19", " 08/11 14:47:20"	- 90 bytes
⋮	

■ Real Time

Real time output displays the alarm state and the time the alarm became that state on a single line each time an alarm occurs, is recovered from, or is confirmed.

The data structure of files output with real time output is as follows. Bold items are replaced by the Alarm Log settings, sampled data, project file name, and WindO/I-NV3 version.

Headers	"Project Name", " Project name ", " Version number "
	"File Type", " Log type "
	Blank row
Title row	"Time", "State", "Ch.No.", "Message"
Data row	" MM/DD/YYYY HH:MM:SS ", " State ", " Channel number ", " Message "
	⋮

Output example

"Project Name", "Dimmer Console", "V1.00"	Data size of each row
"File Type", "Alarm Log Data"	- 41 bytes
	- 30 bytes
	- 2 bytes
"Time", "State", "Ch.No.", "Message"	- 35 bytes
" 08/11/2011 14:46:12", "Occurred", " 1-0", "Voltage drop"	- 57 bytes
" 08/11/2011 14:46:13", "Recovered", " 1-0", "Voltage drop"	- 58 bytes
" 08/11/2011 14:46:16", "Confirmed", " 1-0", "Voltage drop"	- 58 bytes
" 08/11/2011 14:47:18", "Occurred", " 1-1", "Temperature abnormal"	- 65 bytes
⋮	



- The data size for each row is counted as 2 bytes for full-width characters, one byte for half-width characters, and two bytes for newlines. The total for each row is the total amount of space for the file.
- A space is inserted before the date in the data row.
- The display type for the date and time varies based on the language configured in **Project Settings**, on the **Project Details** tab, in **Language**.

Japanese: YYYY/MM/DD HH:MM:SS

European, Chinese, Taiwanese, Korean, Central European, Baltic, Cyrillic: MM/DD/YYYY HH:MM:SS

Chapter 14 Data Log Function

This chapter describes how to configure the Data Log function and its operation on the Touch.

1 Overview

1.1 How the Data Log Function is Used

The Data Log function samples values of devices with the Touch using the configured sampling condition. The sampled values of devices are saved in internal memory along with the sampling time.

The Data Log function can perform the following functions.

- Sample values of devices at a fixed time interval

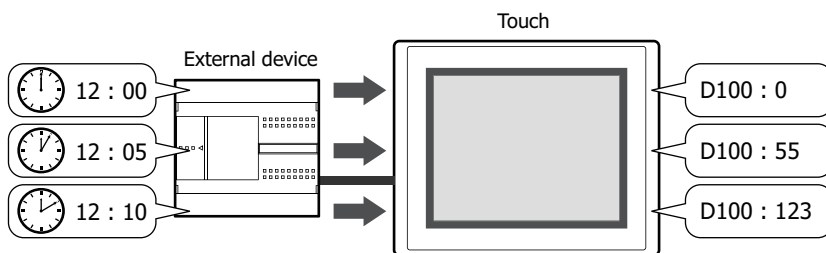

- Sample values of devices when a value of device changes

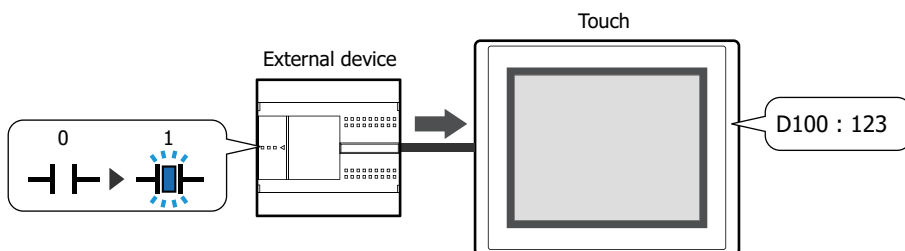

- Output Data Log data to the external memory

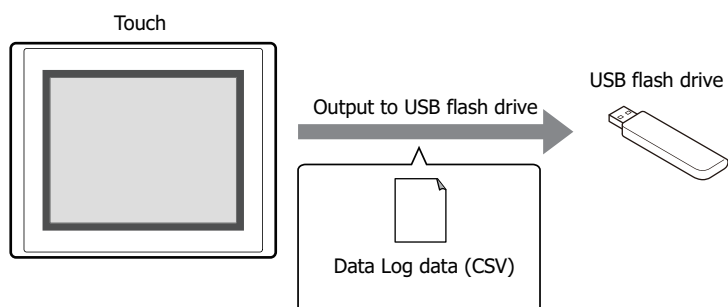

- Copy Data Log data to internal devices

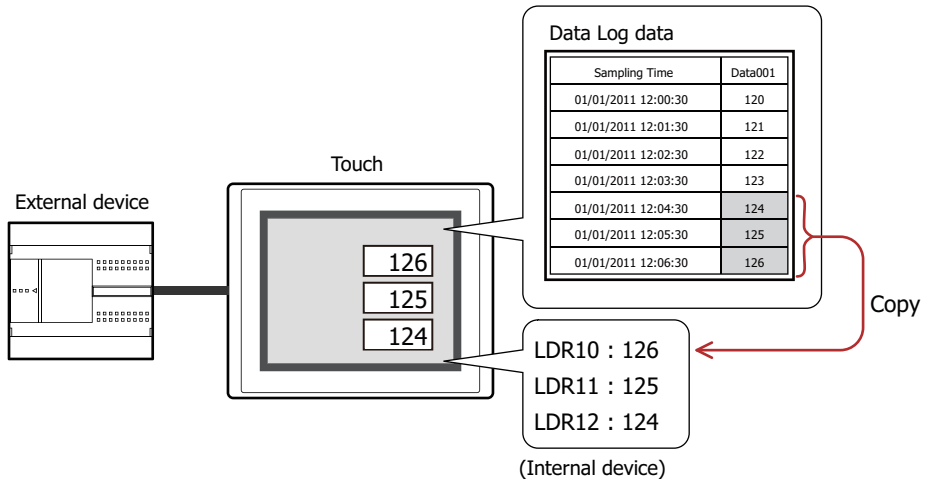

1.2 Sampling Values of Devices

The Touch samples target values of devices at a fixed time interval or when a value of device changes.

● Sampling Values of Devices at a Fixed Time Interval

When sampling values of devices (D100 to D102) at a 5 minute interval (Time: 300 seconds) with the data storage amount in the data storage area is set to 3, the Touch samples Data Log data as follows.

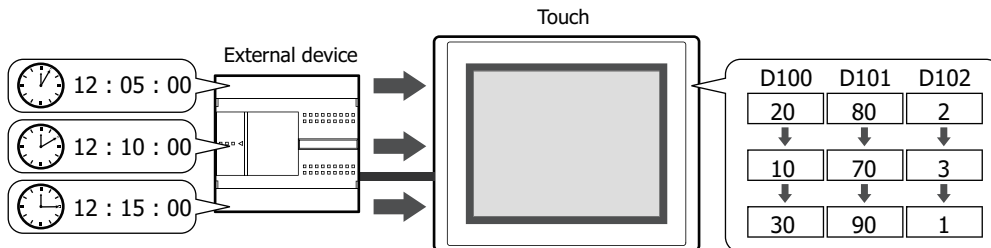

- 1 5 minutes after data sampling starts, the Touch stores the values for devices D100 to D102.
- 2 10 minutes after data sampling starts, the Touch stores the values for devices D100 to D102.
- 3 15 minutes after data sampling starts, the Touch stores the values for devices D100 to D102.

Time	Value		
	D100	D101	D102
01/01/2011 12:01:00	10	70	3
01/01/2011 12:02:00	20	80	2
01/01/2011 12:03:00	30	90	1
01/01/2011 12:04:00	10	70	3
01/01/2011 12:05:00	20	80	2
01/01/2011 12:06:00	30	90	1
01/01/2011 12:07:00	10	70	3
01/01/2011 12:08:00	20	80	2
01/01/2011 12:09:00	30	90	1
01/01/2011 12:10:00	10	70	3
01/01/2011 12:11:00	20	80	2
01/01/2011 12:12:00	30	90	1
01/01/2011 12:13:00	10	70	3
01/01/2011 12:14:00	20	80	2
01/01/2011 12:15:00	30	90	1
01/01/2011 12:16:00	10	70	3

Sampling Time	Value		
	Data 1	Data 2	Data 3
01/01/2011 12:05:00	20	80	2
01/01/2011 12:10:00	10	70	3
01/01/2011 12:15:00	30	90	1

- 4 20 minutes after data sampling starts, the Touch stores the values for devices D100 to D102.

Since the data storage amount in the data storage area is set to 3, the oldest data is deleted in order to make room for the newest data.

Time	Value		
	D100	D101	D102
⋮	⋮	⋮	⋮
01/01/2011 12:17:00	40	60	2
01/01/2011 12:18:00	30	60	1
01/01/2011 12:19:00	10	90	3
01/01/2011 12:20:00	20	80	2

Sampling Time	Value		
	Data 1	Data 2	Data 3
⋮	⋮	⋮	⋮
01/01/2011 12:10:00	10	70	3
01/01/2011 12:15:00	30	90	1
01/01/2011 12:20:00	20	80	2

● Sampling Values of Devices when Value of Device Changes

When sampling values of devices (D100 to D102), when a bit device configured as the sampling condition switches from 0 to 1 and the data storage amount in the data storage area is set to 3, the Touch samples Data Log data as follows.

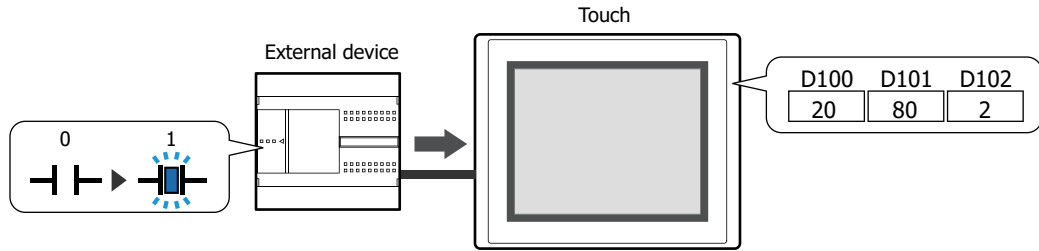

- 1 When data sampling starts and the bit device configured as the sampling condition switches from 0 to 1, the Touch stores the values for devices D100 to D102.
- 2 When the sampling condition device switches from 0 to 1 the second time, the Touch stores the values for devices D100 to D102.
- 3 When the sampling condition device switches from 0 to 1 the third time, the Touch stores the values for devices D100 to D102.

Values of Devices				Data stored on the Touch			
Time	Value			Sampling Time	Value		
	D100	D101	D102		Data 1	Data 2	Data 3
01/01/2011 12:01:00	10	70	3				
01/01/2011 12:02:00	20	80	2				
01/01/2011 12:03:00	30	90	1				
01/01/2011 12:04:00	10	70	3				
01/01/2011 12:05:00	20	80	2	01/01/2011 12:05:00	20	80	2
01/01/2011 12:06:00	30	90	1				
01/01/2011 12:07:00	10	70	3				
01/01/2011 12:08:00	20	80	2				
01/01/2011 12:09:00	30	90	1				
01/01/2011 12:10:00	10	70	3				
01/01/2011 12:11:00	20	80	2				
01/01/2011 12:12:00	30	90	1	01/01/2011 12:13:00	10	70	3
01/01/2011 12:13:00	10	70	3				
01/01/2011 12:14:00	20	80	2	01/01/2011 12:15:00	30	90	1
01/01/2011 12:15:00	30	90	1				
01/01/2011 12:16:00	10	70	3				

- 4 When the sampling condition device switches from 0 to 1 the fourth time, the Touch stores the values for devices D100 to D102.

Since the data storage amount in the data storage area is set to 3, the oldest data is deleted in order to make room for the newest data.

Values of Devices				Data stored on the Touch			
Time	Value			Sampling Time	Value		
	D100	D101	D102		Data 1	Data 2	Data 3
...				
01/01/2011 12:17:00	40	60	2				
01/01/2011 12:18:00	30	60	1				
01/01/2011 12:19:00	10	90	3				
01/01/2011 12:20:00	20	80	2	01/01/2011 12:20:00	20	80	2
				01/01/2011 12:15:00	30	90	1
				01/01/2011 12:13:00	10	70	3

1.3 Data Configuration

The sampled data is composed of the sampling time, values of devices, and labels.
 The relationship between the Data Log function settings and the sampled data is as follows.

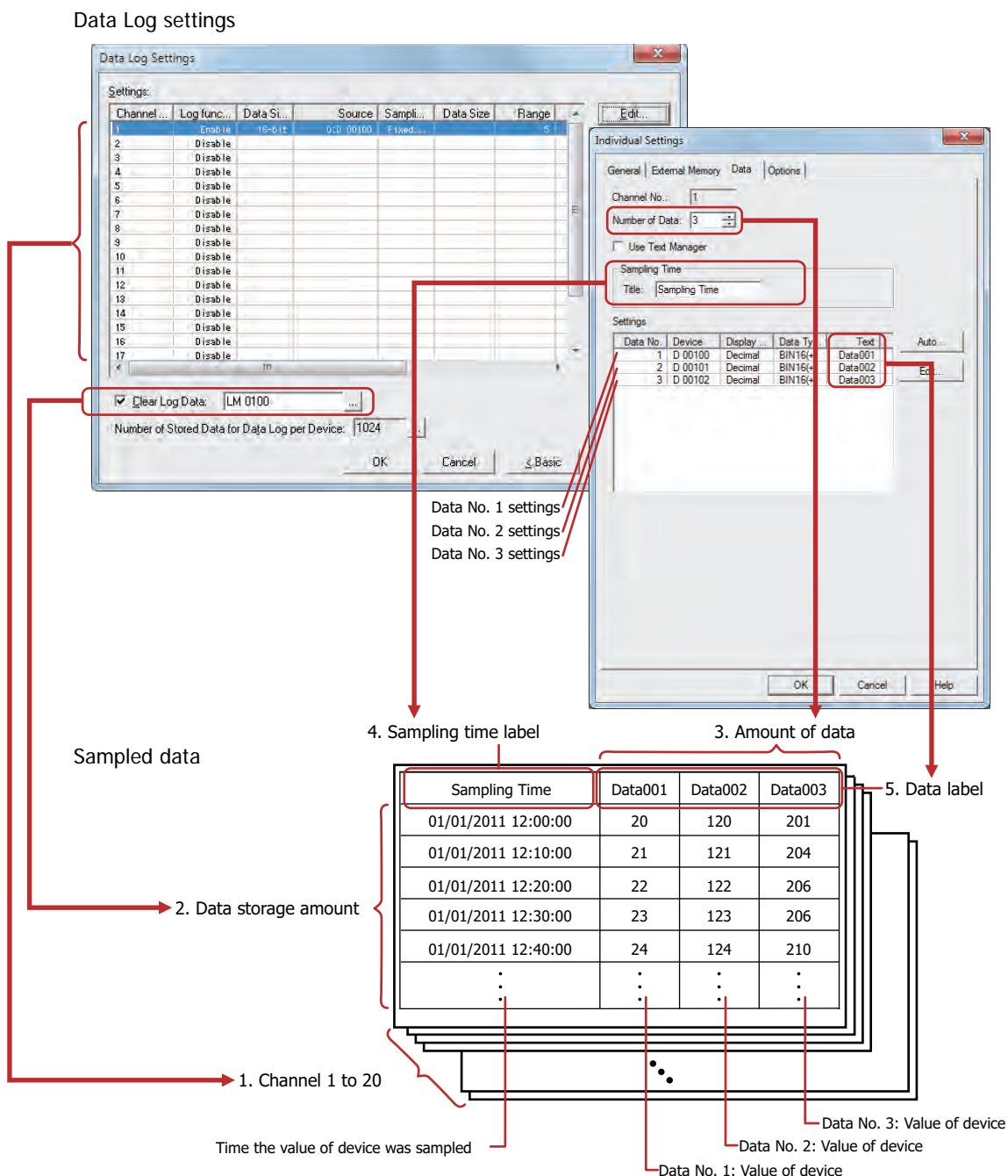

- 1. Channel: The sampled data is in channel units. A maximum of 20 channels can be configured.
- 2. Data storage amount: The amount of sampled data to save. The maximum amount that can be configured per device differs according to the model. For details, refer to "Data Storage Amount" on page 14-6.
- 3. Amount of data: The amount of data configured for a channel. The maximum amount of data that can be configured is 128. The maximum number of devices that can be configured to sample values is 128 total for all channels. For example, when the amount of data for channel 1 is set to 128, this is the maximum amount total for all channels, so channel 2 through 20 cannot be configured.
- 4. Sampling time label: When the sampled data is output as a CSV file, this label is displayed in the label row for the sampling time column.
- 5. Data label: When the sampled data is output as a CSV file, this label is displayed in the label row for the data number columns.

1.4 Saving and Deleting Data

● Saving Data

The sampled values of devices, along with the sampling time, are all saved in the data storage area.

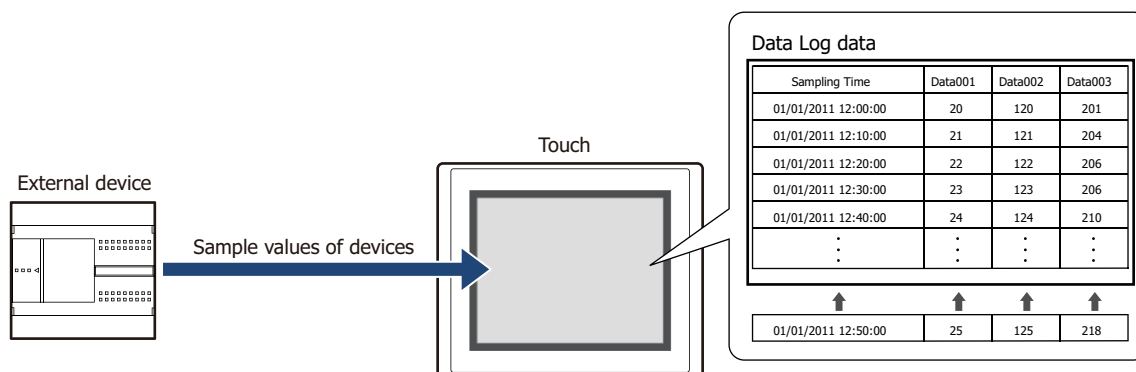

If the saved data exceeds the Data Log data storage amount per device, the old data is deleted and the new data is saved.

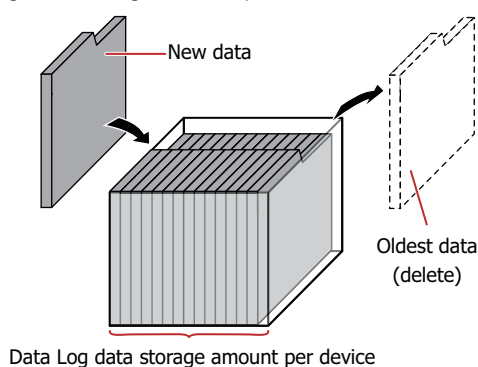

When the backup battery is depleted, the data in the Data Log is erased when the Touch is turned off.

Data Storage Amount

When saving the sampled data to the data storage area, set the data storage amount per device. The amount of data that can be saved in the data storage area is calculated from the configured data storage amount per device and data amount for each channel.

The maximum amount of data that can be saved in the data storage area is 12,528. When saving two devices, the number of data that can be saved in the data storage area is 6,264.

● Deleting Data

The method to delete sampled data from the data storage area is as follows.

- On the **Online** tab in WindO/I-NV3, click the arrow under **Clear**, and then click **All** or **Data Log Data**. For details, refer to Chapter 23 "4 Clear" on page 23-22.
- Press **Main Menu** on the Top Page in the System Mode, **Initial Setting**, **Initialize**, **Data Log** in order.

1.5 Using the Data

The saved data can be used in the following ways.

Data Log data

Sampling Time	Data001	Data002	Data003
01/01/2011 12:00:00	20	120	201
01/01/2011 12:10:00	21	121	204
01/01/2011 12:20:00	22	122	206
01/01/2011 12:30:00	23	123	206
01/01/2011 12:40:00	24	124	210
⋮	⋮	⋮	⋮

To use with the Touch

To use with devices other than the Touch

- Display the data in the Line Chart
Configure the data channel numbers and data numbers and display the data in the Line Chart. For details, refer to “4.1 Display the Data in the Line Chart” on page 14-25.

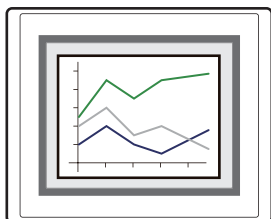

- Display the data with the Numerical Input or the Numerical Display
Copy the data to an internal device and display it with the Numerical Input or the Numerical Display. For details, refer to “4.2 Displaying Data as Numerical Values” on page 14-27.

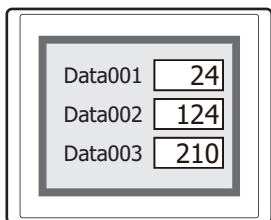

- Save to and read from an external memory
Data Log data is saved in a CSV file format into the external memory which it can be read on your computer. For details, refer to “4.3 Saving Data as a CSV File” on page 14-37.

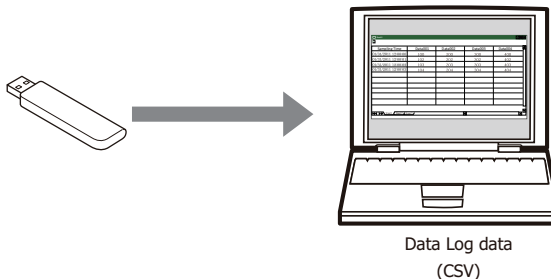

2 Data Log Function Configuration Procedure

This section describes the configuration procedure for the Data Log function.

2.1 Configuring the Sampling Condition and Devices for Sampling Data

- 1 On the **Configuration** tab, in the **System Setup** group, click **Data Log**.

The Data Log Settings dialog box is displayed.

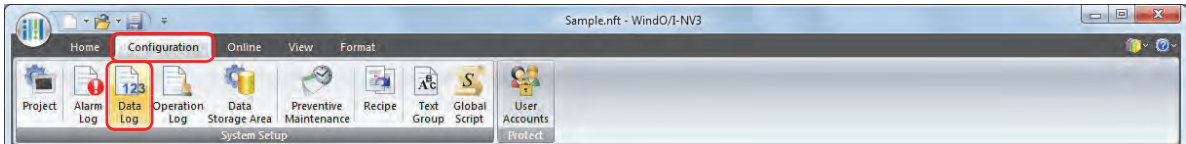

- 2 Select the channel number to register the Data Log settings to in **Settings**, then click **Edit**.

The Individual Settings dialog box is displayed.

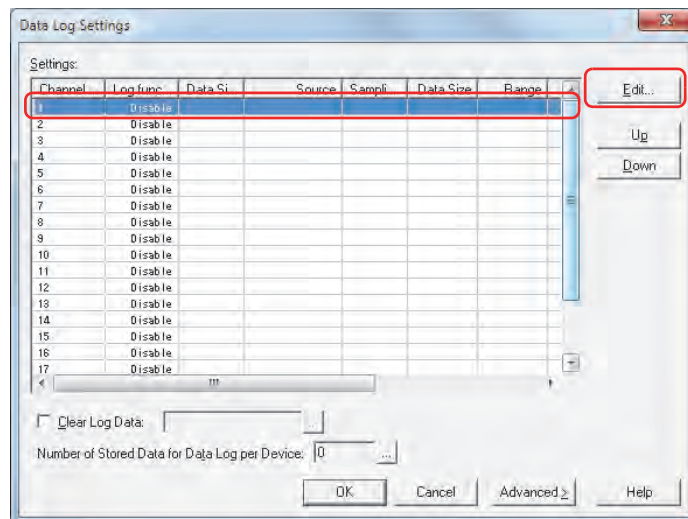

- 3 On the **General** tab, under **Log function**, select **Enable**.

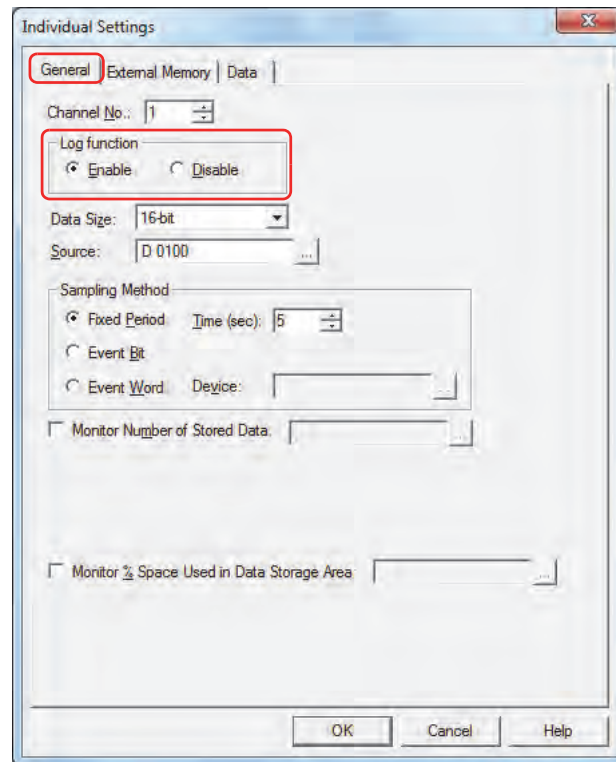

- 4 Select the data size for the source device in **Data Size**.

- 5 Specify the device for sampling data in **Source**.

Click to display the Device Address Settings dialog box. For the device address configuration procedure, refer to Chapter 2 "5.1 Device Address Settings" on page 2-61.

- 6 Select the condition for sampling data under **Sampling Method**.

■ **Fixed Period**

Samples the value of source device at a fixed interval. If **Fixed Period** is selected, specify **Time** in seconds.

■ **Event Bit**

Samples the value of source device each time the monitored bit device or bit of the word device changes from 0 to 1. If **Event Bit** is selected, specify the device to monitor as the condition for sampling data in **Device**.

Click to display the Device Address Settings dialog box. For the device address configuration procedure, refer to Chapter 2 "5.1 Device Address Settings" on page 2-61.

■ **Event Word**

Samples the value of source device each time the value of monitored word device changes. Specify the word device to monitor as the condition for sampling data in **Device**.

Click to display the Device Address Settings dialog box. For the device address configuration procedure, refer to Chapter 2 "5.1 Device Address Settings" on page 2-61.

- 7 Click the **Data** tab.

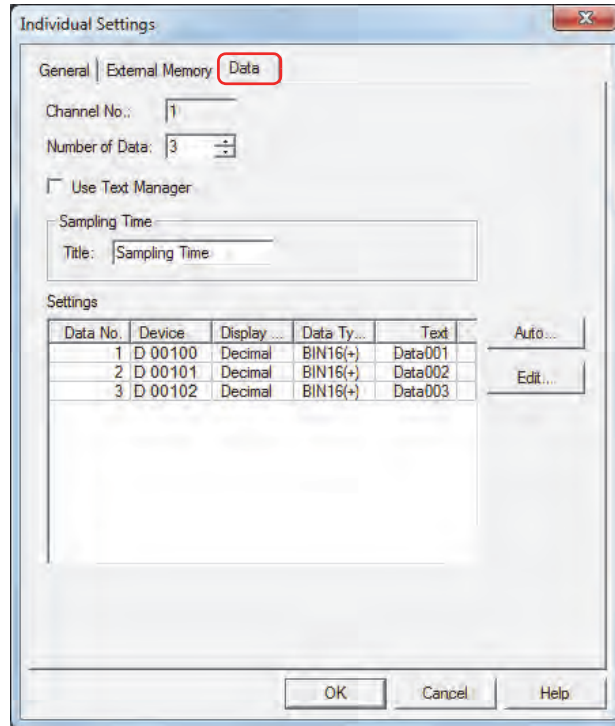

The channel number selected on the **General** tab is displayed in **Channel No.**

- 8 In **Number of Data**, specify the number of devices to sample starting with the source device configured on the **General** tab.

The sequential devices from the starting address for the number of configured devices are displayed in **Settings**.

- 9 Enter the label to display in the sampling time column when the data is output as CSV under **Sampling Time**, in **Label**.

To use text registered in Text Manager, select the **Use Text Manager** check box and specify the ID number of the text to use as the label.

Click  to open Text Manager where you can edit the text.

- 10 Configure the details in **Settings**.

To batch register all the data settings for all data numbers, click **Auto**.

To individually register the data settings for each data number, select a data number, and then click **Edit**.

The dialog box that corresponds to each button is displayed.

An example when **Edit** is clicked is described here.

- 11 Check that the data number selected under **Settings** in **Data No.** is displayed.

- 12 Select the display type for the sampled value of device with **Display Type**.

The display type selected here is the display type for the numerical values when the data is output as CSV.

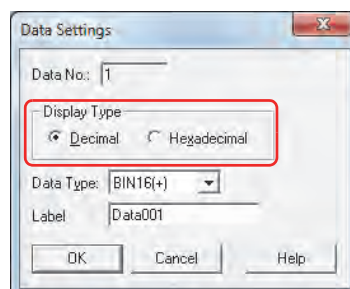

- 13 Select the data type for the sampled value of device with **Data Type**.

The data type selected here is the data type for the numerical values when the data is output as CSV.

14 Enter the text to display in the data label in **Label**.

The text entered here is the label row for the data number columns when the data is output as CSV.

If you selected the **Use Text Manager** check box on the **Data** tab, specify the ID number for the text to use in the label.

15 Click **OK** to close the Data Settings dialog box.

To individually register Data Log settings on the Individual Settings dialog box, repeat steps **11** through **14**.

16 Click **OK** to close the Individual Settings dialog box.**17** Repeat steps **2** through **16** to register Data Log settings for all of the channel numbers to use.**18** Specify the Data Log data storage amount per device.

Click **...** for **Number of Stored Data for Data Log per Device** to display the Data Storage Area Management dialog box.

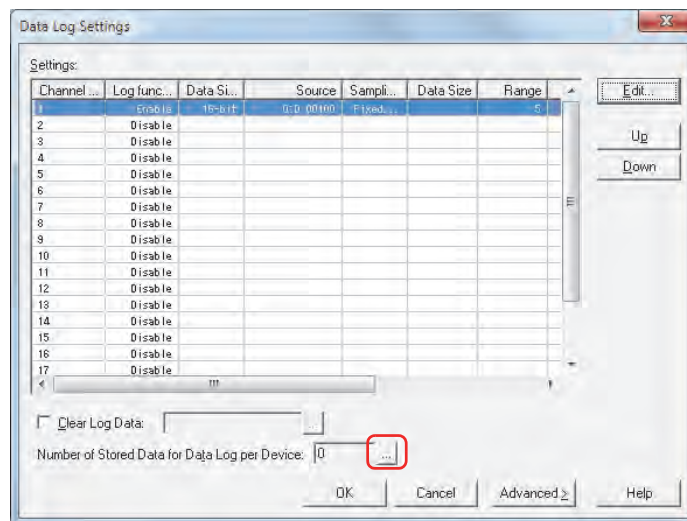

Increase the number for **Number of Stored Data for Data Log per Device**.

Click **OK** to close the Data Storage Area Management dialog box.

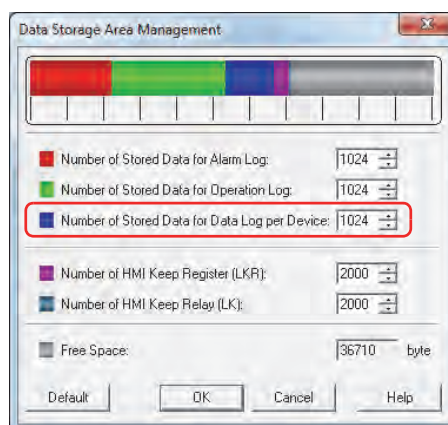
**19** Click **OK**.

The Data Log Settings dialog box closes.

This concludes configuring the sampling conditions and devices for sampling data.

Next, configure the functions to execute using sampled data.

☞ “4.1 Display the Data in the Line Chart” on page 14-25

☞ “4.2 Displaying Data as Numerical Values” on page 14-27

☞ “4.3 Saving Data as a CSV File” on page 14-37

3 Data Log Settings Dialog Box

This section describes the items and buttons on the Data Log Settings dialog box and the Individual Settings dialog box.

3.1 Data Log Settings Dialog Box

All the devices to sample values from and their sampling conditions are collectively managed in the Data Log Settings dialog box.

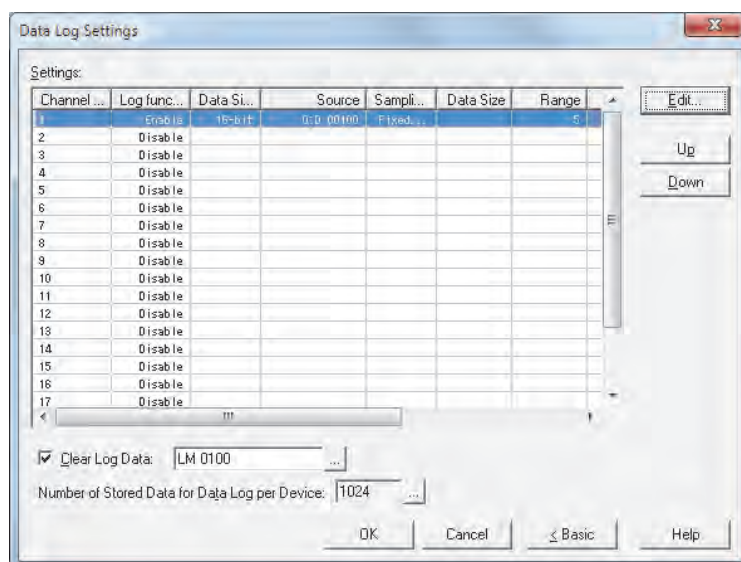

■ Settings

Edits the Data Log settings for each channel.

Channel No.: Shows the channel number. Double clicking the cell displays the Individual Settings dialog box where you can edit the settings. For details, refer to “3.2 Individual Settings Dialog Box” on page 14-14.

Log function: Shows whether or not the Data Log function is used. Double clicking the cell switches between **Enable** and **Disable**. If switched to **Disable**, that channel's settings all return to the default settings.

Data Size: Shows the data size for the source device. Double clicking the cell switches between 16-bit and 32-bit. This option can only be set when Enable is selected in Log Function.

Source: Specifies the device to sample values from. Double clicking the cell displays the Device Address Settings dialog box where you can edit the device address. For the device address configuration procedure, refer to Chapter 2 “5.1 Device Address Settings” on page 2-61. This option can only be set when **Enable** is selected in **Log Function**.

The size of the data to sample is 16 bits.

Sampling Method: Shows the condition for sampling data. Double clicking the cell switches between **Fixed Period**, **Event Bit**, and **Event Word**. This option can only be set when **Enable** is selected in **Log Function**.

Data Size: Shows the data size for the device that is the sampling condition. Double clicking the cell switches between 16-bit and 32-bit. This option can only be set when Event Word is selected in Sampling Method.

Range: Shows the time in seconds (1 to 9999) to sample data in a fixed interval when **Fixed Period** is selected in **Sampling Method**. Double clicking the cell displays the Individual Settings dialog box where you can edit the settings. For details, refer to “3.2 Individual Settings Dialog Box” on page 14-14.

Shows the device that is the condition for sampling data when **Event Bit** or **Event Word** is selected in **Sampling Method**. Double clicking the cell displays the Device Address Settings dialog box where you can edit the device address. For the device address configuration procedure, refer to Chapter 2 “5.1 Device Address Settings” on page 2-61.

Monitor:	Shows the write destination device for the amount of data when monitoring the amount of sampled data. Shows No when not monitoring. Double clicking the cell displays the Individual Settings dialog box where you can edit the settings. For details, refer to "3.2 Individual Settings Dialog Box" on page 14-14. This option can only be set when Enable is selected in Log Function .
Batch:	Shows the trigger device that triggers batch output when batch outputting all the data saved in the data storage area to the external memory. Shows No when there is no batch output. Double clicking the cell displays the Individual Settings dialog box where you can edit the settings. For details, refer to "3.2 Individual Settings Dialog Box" on page 14-14.
Real Time:	Shows whether or not to perform real time output. Double clicking the cell switches between Yes and No . Data is output to the external memory in 3 minute intervals for Yes channels. This option can only be set when Enable is selected in Log Function .
No. of Data ^{*1} :	Shows the number of devices to sample in a channel. Double clicking the cell displays the Individual Settings dialog box where you can edit the settings. For details, refer to "3.2 Individual Settings Dialog Box" on page 14-14. This option can only be set when Enable is selected in Log Function .

■ Edit

Registers or changes the settings for the selected channel number.

Select a channel number, and then click this button to display the Individual Settings dialog box. The settings for the selected channel are reflected in the Individual Settings dialog box.

For details, refer to "3.2 Individual Settings Dialog Box" on page 14-14.

■ Up

Shifts the selected settings upward in the list.

■ Down

Shifts the selected settings downward in the list.

■ Clear Log Data

Select this check box to erase the data saved in the data storage area.

(Trigger device): Specifies the bit device that triggers the erasure of the data. The data for all channels is erased when the value of the configured device changes from 0 to 1. For the device address configuration procedure, refer to Chapter 2 "5.1 Device Address Settings" on page 2-61.

■ Number of Stored Data for Data Log per Device

Shows the maximum amount of data storage per device for Data Log data saved in the data storage area. If data is saved up the maximum amount and then the maximum is exceeded, the old data is deleted and the new data is saved. The default is 0.

Click  to display the Data Storage Area Management dialog box where you can change the allocation of data storage area memory. For details, refer to Chapter 16 "Data Storage Area" on page 16-1.

*1 Advanced mode only

3.2 Individual Settings Dialog Box

Use the Individual Settings dialog box to register or edit the Data Log settings for the selected channel.

● General Tab

The **General** tab is used to configure the source devices for sampling data and the sampling conditions.

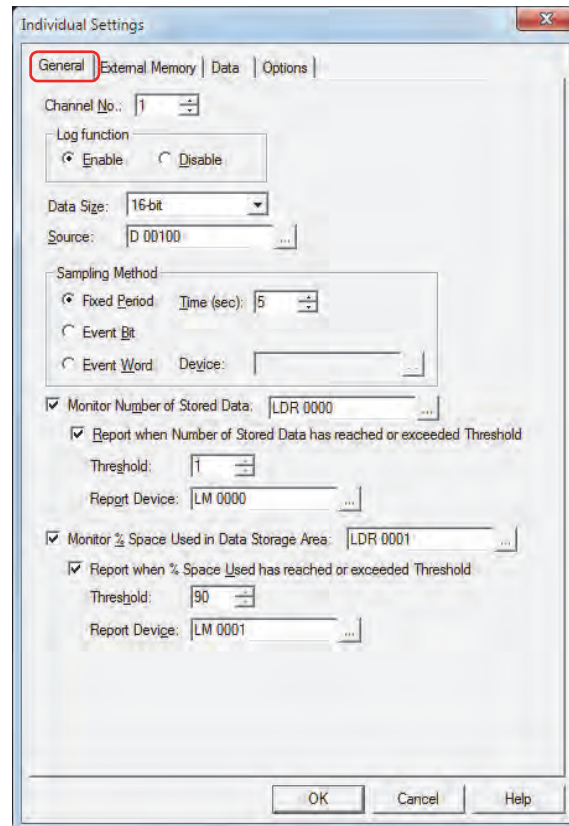

■ Channel No.

Specifies the channel number for sampling data (1 to 20).

■ Log function

Selects whether or not to use the Data Log function.

Enable: Samples values of devices and saves the data along with the sampling time.

Disable: Does not sample values of devices.

■ Data Size^{*1}

Selects the data size of the source device as 16-bit or 32-bit.

The value of device in the selected data size is read and saved in the data storage area.

■ Source

Specifies the word device that is the source for sampling data.

For the device address configuration procedure, refer to Chapter 2 "5.1 Device Address Settings" on page 2-61.

*1 Advanced mode only

■ Sampling Method

Sets the condition for sampling values of devices.

- Fixed Period: Samples the value of source device at a fixed interval.
- Time (sec): Specifies the time in seconds (1 to 9999).
This option can only be set when **Fixed Period** is selected.
- Event Bit: Samples the value of source device each time the bit device or bit of the word device changes from 0 to 1.
- Event Word: Samples the value of source device each time the value of word device changes.
- Device: Specifies the word device that triggers sampling data.
For the device address configuration procedure, refer to Chapter 2 "5.1 Device Address Settings" on page 2-61.
This option can only be set when **Event Bit** or **Event Word** is selected.

■ Monitor Number of Stored Data

Select this check box to monitor the number of times values of devices are sampled. The sampling count is written to the specified device. The maximum sampling count is 12,528.

- (Destination Device): Specifies the destination word device.
For the device address configuration procedure, refer to Chapter 2 "5.1 Device Address Settings" on page 2-61.
- Report when Sampling Count has reached or exceeded Threshold^{*1}:
Writes 1 in the report device when the current sampling count reaches or exceeds the set threshold.
- Threshold^{*1}: Specifies the sampling count (1 to 12,528) that is the basis for reporting.
- Report Device^{*1}: Specifies the destination bit device or the destination bit of the word device.
For the device address configuration procedure, refer to Chapter 2 "5.1 Device Address Settings" on page 2-61.

■ Monitor % Space Used in Data Storage Area

Select this check box to monitor the usage of the allocated data storage area as the save destination for Data Log data. The usage is calculated from the data storage amount allocated to the data storage area and the amount of saved data, and then written to the specified device.

Usage = Current amount of Data Log data ÷ Data Log data storage amount per device (omits values after the decimal point)

- (Destination Device): Specifies the destination word device to write the current usage of the amount of Data Log data storage.
For the device address configuration procedure, refer to Chapter 2 "5.1 Device Address Settings" on page 2-61.
- Report when % Space Used has reached or exceeded Threshold^{*1}:
Writes 1 in the report device when the current usage reaches or exceeds the set threshold.
- Threshold^{*1}: Specifies the usage (1 to 100) that is the basis for reporting.
- Report Device^{*1}: Specifies the destination bit device or the destination bit of the word device.
For the device address configuration procedure, refer to Chapter 2 "5.1 Device Address Settings" on page 2-61.

*1 Advanced mode only

● External Memory Tab

The **External Memory** tab is used to configure whether or not to output saved data to the external memory.

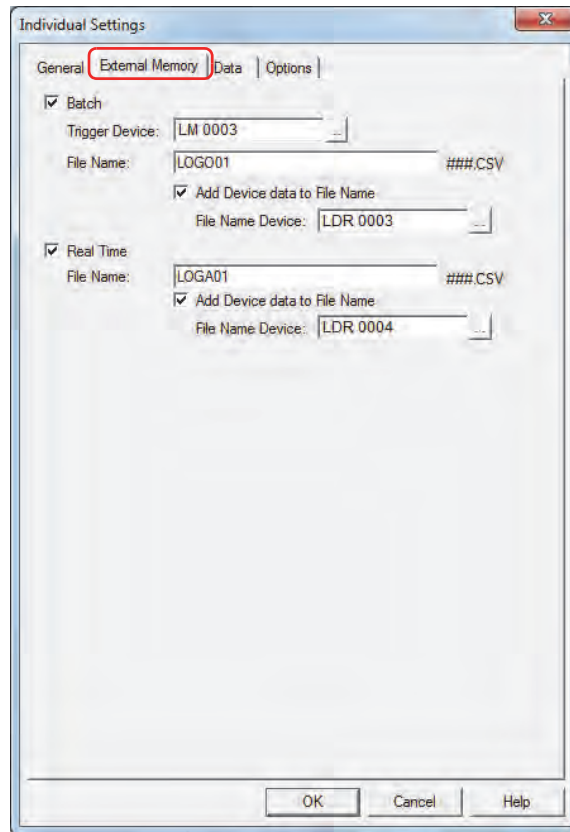

The output data is stored in the following folder on the external memory.

External memory folder\DATALOG

The default External Memory Folder name is "HGDATA01". For details, refer to Chapter 26 "1.5 Setting the External Memory Folder" on page 26-12.



Data that is sampled after starting output to the external memory is not included in the output data.

■ Batch

Select this check box to batch output all the sampled data to the external memory.

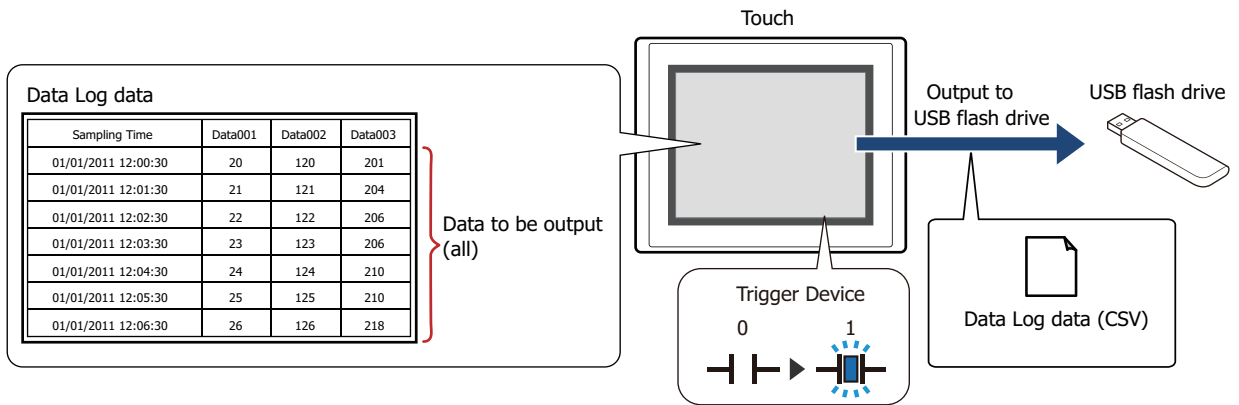

All the data is saved on the external memory when the trigger devices changes from 0 to 1. If a file with the same name already exists on the external memory, that file is overwritten. The maximum amount of output data is the amount configured by the data storage area or 1,024.



Output stops if there is insufficient free space on the external memory. USB flash drive error information is stored in HMI Special Data Register LSD33.

Trigger Device: Specifies the bit device or bit of the word device that triggers batch output. For the device address configuration procedure, refer to Chapter 2 "5.1 Device Address Settings" on page 2-61.

Data is output to file when the trigger device changes from 0 to 1.

File Name: Enter the file name for the output data or shows the file name.

The default is "LOGO n .CSV". (n : Data log channel number)

To change the file name, enter a new file name. The maximum number is 120 characters (including the extension).

Add Device data to File Name^{*1}: Select this check box to add the bottom three digits of the value of device configured by **File Name Device** to the end of file name for the output data.

Example: When the channel number is 1 and the value of device configured by **File Name Device** is 123, the file name is "LOGO01123.CSV".

File Name Device:

Specifies the word device that is the source for the value to add to the file name. For the device address configuration procedure, refer to Chapter 2 "5.1 Device Address Settings" on page 2-61. This option can only be configured when the **Add Device data to File Name** check box is selected.

*1 Advanced mode only

■ Real Time

Select this check box to output data to the external memory in real time.

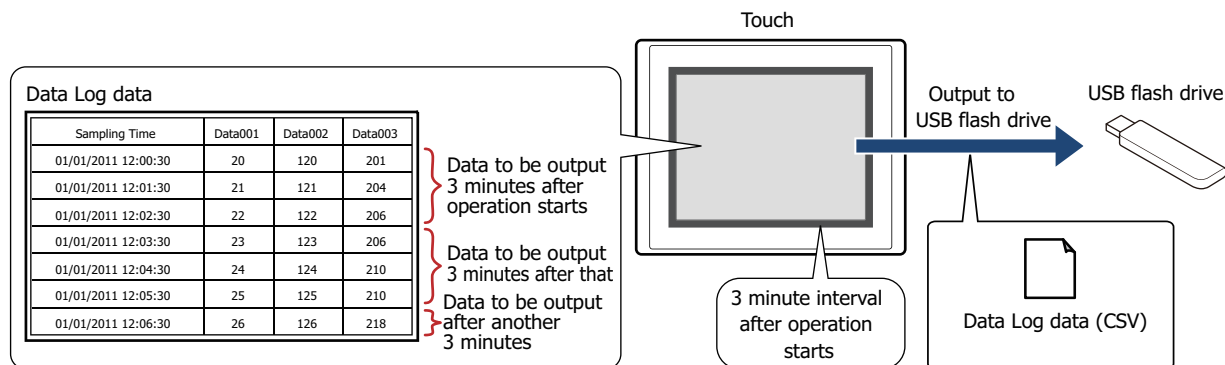

With real time output, data is saved to the external memory in three minute intervals after the Touch starts running. When there is already data with the same file name on the external memory, data is appended to that file. If there was no update to the data during the three minutes, it is not output.

Data is appended to the file until the size of the file reaches the restriction size (256 MB), so the maximum amount of output data differs according to the settings for the output channel such as the amount of data, the data size, and the labels.

If the sampling interval is shorter than real time output (the interval for writing to the external memory), that Data Log is recorded up to the data storage amount - 1, and then afterwards, old data is discarded in order and replaced with new data.



Real time output stops when the file size of the Data Log data exceeds 256 MB or when there is insufficient space on the external memory. USB flash drive error information is stored in HMI Special Data Register LSD33.



- When the value of HMI Special Internal Relay LSM18 changes from 0 to 1, the data at that time is first output in real time to the USB flash drive, and then access to the USB flash drive is stopped.
- The text font configured for the starting device is output as the label font.
- You can check the free space on the USB flash drive with HMI Special Data Registers LSD34 to 35.

File Name: Enter the file name for the output data or shows the file name.

The default is "LOGAn.CSV". (n: Data log channel number)

To change the file name, enter a new file name. The maximum number is 120 characters (including the extension).

Add Device data to File Name^{*1}:

Select this check box to add the bottom three digits of the value of device configured by **File Name Device** to the end of the file name for the output data.

Example: When the channel number is 1 and the value of device configured by **File Name Device** is 123, the file name is "LOGA01123.CSV".

File Name Device:

Specifies the word device that is the source for the value to add to the file name. For the device address configuration procedure, refer to Chapter 2 "5.1 Device Address Settings" on page 2-61. This option can only be configured when the **Add Device data to File Name** check box is selected.



- The function to sample data operates when Data Log data is being saved to the external memory.
- The methods to erase Data Log files saved on the external memory are as follows.
 - To erase files during operation using parts, on the **External Memory** tab on the Project Settings dialog box, select the **Remove Files** and the **All Data Log files** check boxes, and then configure the trigger device. Assign that trigger device to a part.
 - To erase files with WindO/I-NV3, click **Clear** on the **Online** tab, and then click **Stored Data in External Memory** to display the Clear Data dialog box. Select the **Data Log Data** check box, and then click **OK**.

*1 Advanced mode only

● Data Tab

The **Data** tab is used to configure the data to sample.

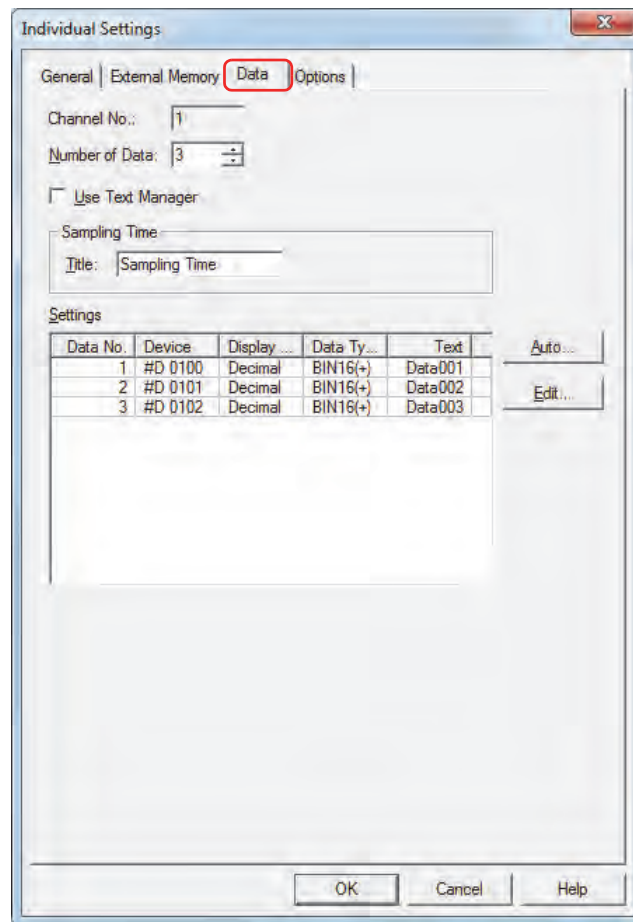

■ Channel No.

Shows the selected channel number.

■ Number of Data

Specifies the number of devices (1 to 128) for sampling data. Samples values of devices in this amount starting with the device configured as the source device on the **General** tab.



The maximum amount of data that can be configured for one channel is 128. However, if 32-bit is selected for Data Size, it is counted as 16-bit data times 2 devices, so the maximum number devices that can be configured for one channel is 64. Data Size is configured with the General tab on the Individual Settings dialog box.

■ Use Text Manager

Select this check box to use text registered in Text Manager for labels when outputting data as CSV.

■ Label

Sampling Time: Specifies the label to display in the sampling time column when outputting data as CSV.

Text ID Specifies the Text Manager ID number (1 to 32000) when text registered in Text Manager are used for labels.

Click to open Text Manager where you can edit the text.

This option is only enabled if you select the **Use Text Manager** check box.

(Text) Enter the text to display in the label. The maximum number is 40 characters.

Text can only be entered when the **Use Text Manager** check box is cleared. The registered text is displayed when a text ID is specified.

■ Settings

Settings is used to configure the details of the data to sample for each data number in the selected channel.

- Data No.: Shows the data numbers for the amount of data specified by **Number of Data**. Double clicking the cell displays the Data Settings dialog box. The data number cannot be edited. For details, refer to "Auto-Setup Dialog Box and Data Settings Dialog Box" on page 14-21.
- Device: Shows the device as sequential numbers starting with the source device specified on the **General** tab. Double clicking the cell displays the Data Settings dialog box. The device cannot be edited. For details, refer to "Auto-Setup Dialog Box and Data Settings Dialog Box" on page 14-21.
- Display Type: Shows the display type for numerical values when data is output as CSV. Double clicking the cell displays the Data Settings dialog box where you can edit the data settings. For details, refer to "Auto-Setup Dialog Box and Data Settings Dialog Box" on page 14-21.
- Data Type: Shows the data type for numerical values when data is output as CSV. Double clicking the cell displays the Data Settings dialog box where you can edit the data settings. For details, refer to "Auto-Setup Dialog Box and Data Settings Dialog Box" on page 14-21.
- Text ID: Shows the Text Manager ID number when text registered in Text Manager is used for labels. Double clicking the cell opens Text Manager where you can edit the text.
Text ID is only displayed when you select the **Use Text Manager** check box.
- Label: Shows the text to display as labels when data is output as CSV. Double clicking the cell allows you to edit the label. The maximum number is 40 characters.
Text can only be entered when the **Use Text Manager** check box is cleared.
The default label is "Data" and the data number.
Example: Data001

■ Auto

Batch registers or changes the settings for all the data.

Click this button to display the Auto-Setup dialog box. The details configured on the Auto-Setup dialog box are registered for all the data.

For details, refer to "Auto-Setup Dialog Box and Data Settings Dialog Box" on page 14-21.

■ Edit

Registers or changes the settings for the selected data.

Select the data, and then click this button to display the Data Settings dialog box. The details configured on the Data Settings dialog box are registered or changed for the selected data.

For details, refer to "Auto-Setup Dialog Box and Data Settings Dialog Box" on page 14-21.

Auto-Setup Dialog Box and Data Settings Dialog Box

With the Auto-Setup dialog box, all the data for the selected channel is batch registered or changed.

With the Data Settings dialog box, the selected data for the selected channel is registered or changed.

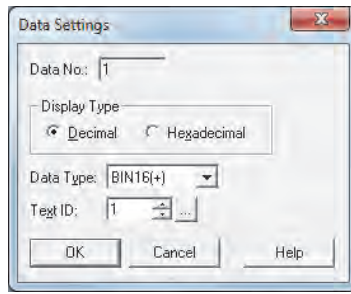

- Data No.:** Displays 1 when the Auto-Setup dialog box was displayed by clicking **Auto**.
Displays the data number for the selected data when the Data Settings dialog box was displayed by clicking **Edit**.
- Display Type:** Select the display type as **Decimal** or **Hexadecimal** for numerical values when data is output as CSV.
- Data Type:** Select the data type for numerical values when data is output as CSV. For details, refer to Chapter 2 "1.1 Available Data" on page 2-1.
When **float32** is selected, the maximum number of digits for the integer part is 10 and the number of digits for the decimal part is 5.
- Text ID:** Specifies the Text Manager ID number (1 to 32000) when text registered in Text Manager are used for labels. For the Auto-Setup dialog box, **Text ID** is automatically configured sequentially starting with the specified text ID.
Click **...** to open Text Manager where you can edit the text.
Text ID can only be configured when you select the **Use Text Manager** check box.
- Label:** Enter the text to display as the label when data is output as CSV. The maximum number is 40 characters.
The default label is Data+number.
Example: Data001
This item is only displayed on the Data Settings dialog box when the **Use Text Manager** check box is cleared.

● Options Tab

The **Options** tab only appears in Advanced mode. To switch to Advanced mode, click **Advanced** on the Data Log Settings dialog box.

To display the data saved in the data storage area as numerical values on the Touch, copy this data to the specified internal device.

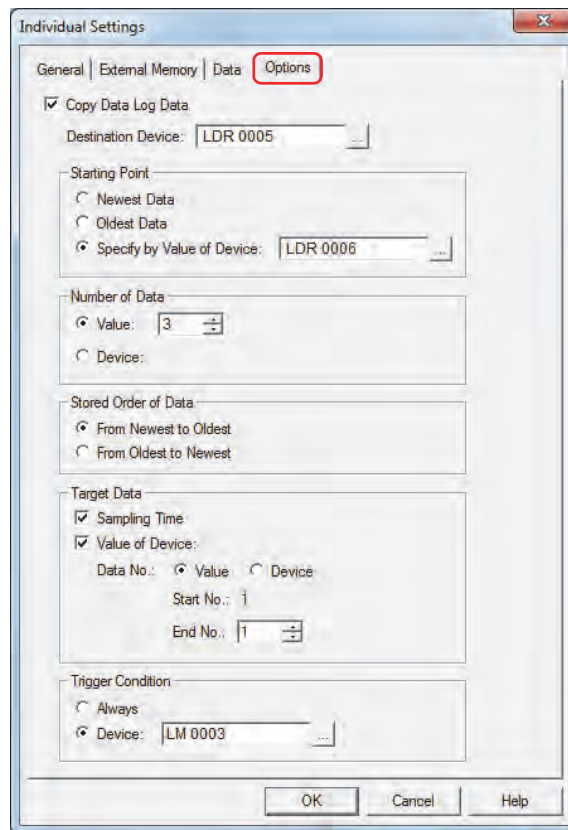

■ Copy Data Log Data

Select this check box to copy data to a device.

Destination Device: Specifies the destination device for copied data. You can only specify an internal device. For the device address configuration procedure, refer to Chapter 2 “5.1 Device Address Settings” on page 2-61.

■ Starting Point

Selects the starting point of the data to copy.

Newest Data: Sets the starting point as the newest data.

Oldest Data: Sets the starting point as the oldest data.

Specify by Value of Device: Specifies which data from the oldest data to set as the starting point.

Specifies the source word device. You can only specify an internal device.

For the device address configuration procedure, refer to Chapter 2 "5.1 Device Address Settings" on page 2-61.

Example: 1. For **Newest Data**, the starting point is the newest sampling time data.

2. For **Oldest Data**, the starting point is the oldest sampling time data.

3. For **Specify by Value of Device** and source device: 3, the starting point is the third item of data from the oldest sampling time data.

Data Log data		
	Sampling Time	Value
2. Oldest Data read starting point →	12/18/2011 17:44:10	20
	12/18/2011 18:34:10	21
3. Specify by Value of Device read starting point (source device: 3) →	12/19/2011 19:24:43	22
	12/19/2011 20:01:54	24
	12/19/2011 21:39:21	26
1. Newest Data read starting point →	12/20/2011 05:57:06	28

■ Number of Data

Selects the specification method for the amount of data to copy.

Value: Uses a constant.

Specifies the amount to copy (1 to 64).

Device: Uses a word device.

Specifies the source word device. You can only specify an internal device.

For the device address configuration procedure, refer to Chapter 2 "5.1 Device Address Settings" on page 2-61.



The maximum amount of data that can be copied to the internal device is 64.

■ Stored Order of Data

Selects the order to copy data.

From Newest to Oldest: Of the data to copy, copies from the start point in order of the newest data first.

From Oldest to Newest: Of the data to copy, copies from the start point in order of the oldest data first.

Example: When **Starting Point** is **Newest Data** and **Number of Data** is 3, data is copied in the following order starting from device LDR10 configured in **Destination Device**.

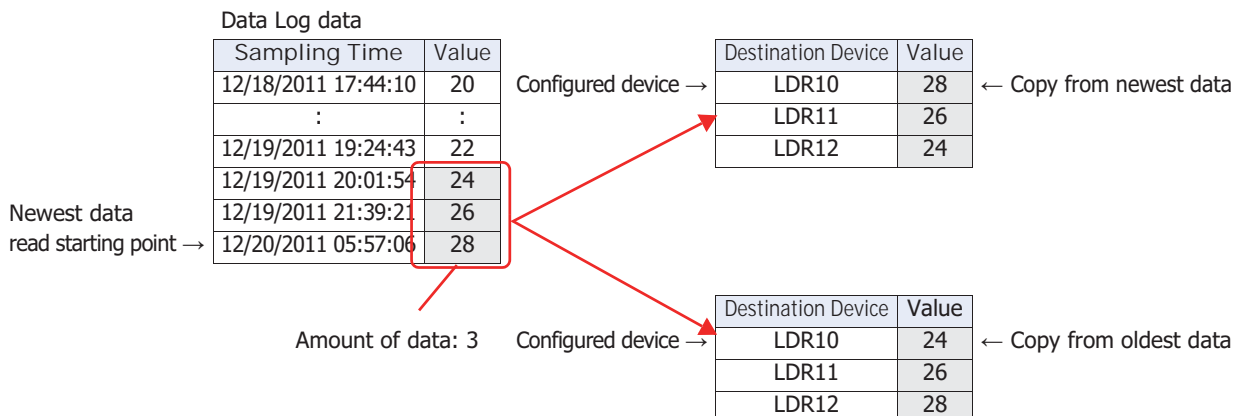

■ **Target Data**

Selects the data to copy from the Data Log data.

Sampling Time: Select this check box to copy the sampling time data from the Data Log data. When this check box is selected, values of devices are copied in order from the data for data number 1.

Value of Device: Select this check box to copy the value of device from the Data Log data.

Data No.: Selects the specification method for the data number of the value to copy.

Value: Uses a constant.

Device: Uses a word device.

Start No.: Of the data to copy, specifies the data number of the data to start copying.

If you select **Value**, specify the data number (1 to 128).

If you select **Device**, specify the source device. You can only specify an internal device. For the device address configuration procedure, refer to Chapter 2 "5.1 Device Address Settings" on page 2-61.

When the **Sampling Time** check box is selected, the data number is 1. This cannot be changed.

End No.: Of the data to copy, specifies the data number of the data to end copying.

If you select **Value**, specify the data number (1 to 128).

If you select **Device**, specify the source device. You can only specify an internal device. For the device address configuration procedure, refer to Chapter 2 "5.1 Device Address Settings" on page 2-61.

Example: When **Start No.** is 2 and **End No.** is 4, data 2 to 4 is the copy target.

		Start No.		End No.	
Data No.:	1	2	3	4	5
	↓	↓	↓	↓	↓
Sampling Time	Data 1	Data 2	Data 3	Data 4	Data 5
10/01/2011 12:34:56	100	60	240	60	240
10/02/2011 03:45:12	200	80	450	80	450

Copy target

■ **Trigger Condition**

Selects the condition to start copying.

Always: Copies each time the data is updated.

Device: Specifies the device that triggers the start of copying the data. Copies the data when the value of the specified device changes from 0 to 1.

For the device address configuration procedure, refer to Chapter 2 "5.1 Device Address Settings" on page 2-61.

4 Using the Data

4.1 Display the Data in the Line Chart

You can display the sampled data in the Line Chart.

- 1 On the **Home** tab, in the **Parts** group, click **Charts**, and then click **Line Chart**.

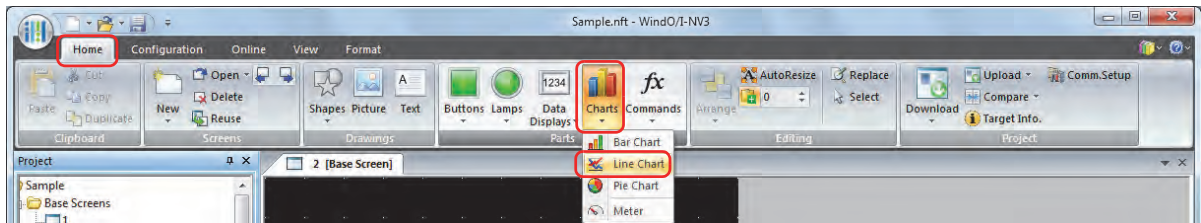

- 2 Click a point on the edit screen where you want to place the Line Chart.
- 3 Double-click the dropped Line Chart and a Properties dialog box will be displayed.

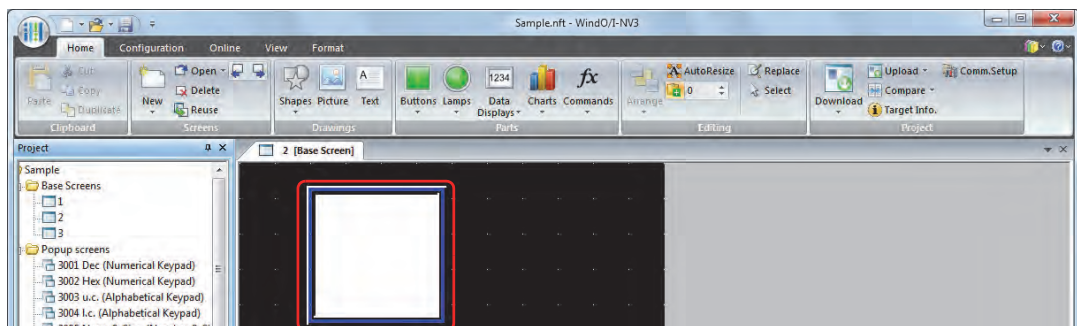

- 4 On the **General** tab, select **Chart Type** as **Log Trend (Normal)** or **Log Trend (Pen Recorder)**.

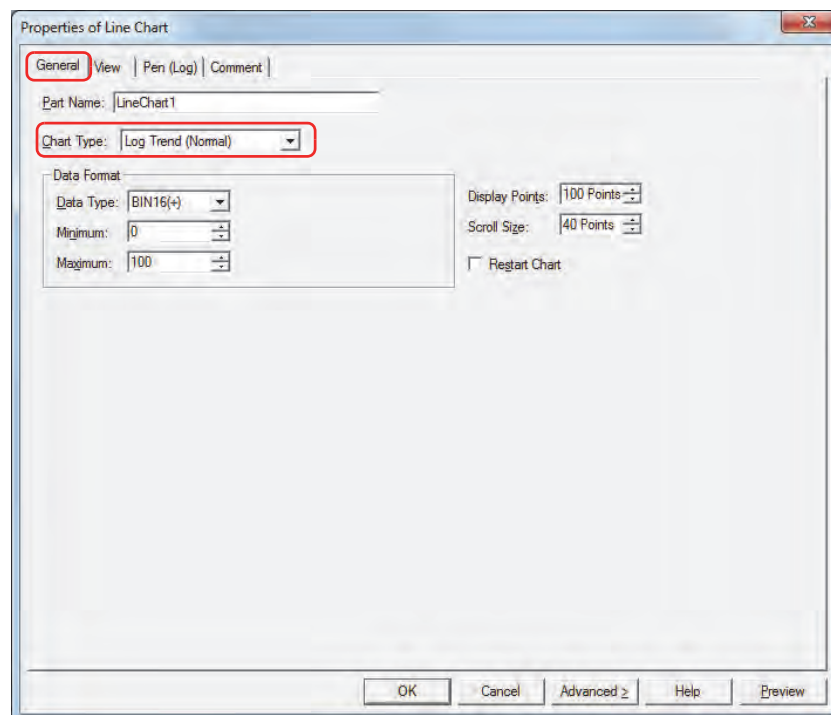

- 5 Click the **Pen (Log)** tab.

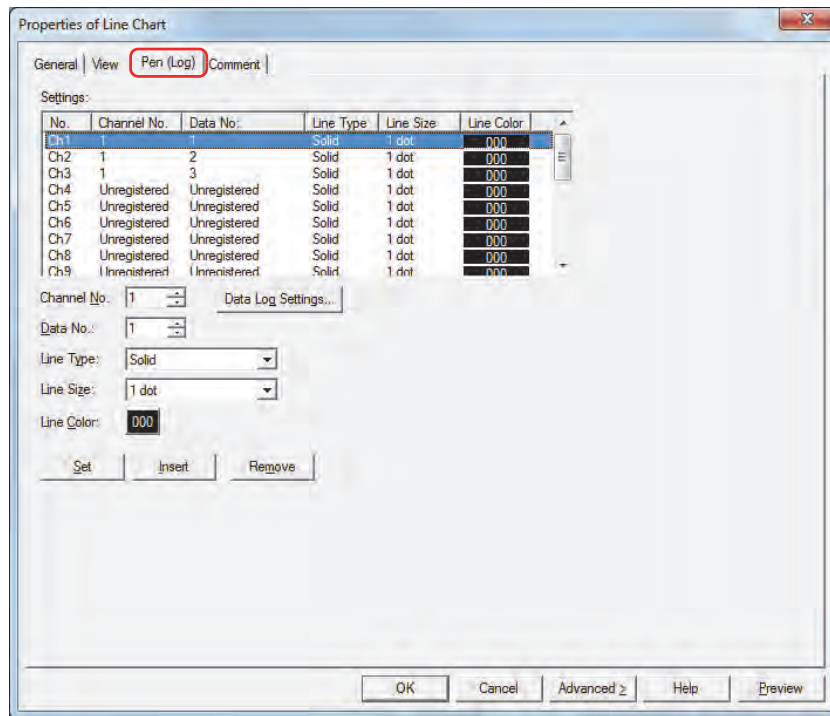

- 6 Specify **Channel No.** and **Data No.** for the data to display in the chart.



Click **Data Log Settings** to display the Data Log Settings dialog box where you can configure the channel while checking the data to display. Select **Channel No.** under **Settings**, and then click **OK** to close the Data Settings dialog box. **Channel No.** reflects the selected channel number.

- 7 Select **Line Type**, **Line Size**, and **Line Color**.

- 8 Click **Set**.

The data to display in the chart is registered in the channel number (Ch1 to Ch20) for the chart selected in **Settings**.

- 9 Repeat steps 6 through 8 to register the data to display in the chart.

- 10 Click **OK**.

The Properties dialog box closes.

This concludes configuring the Line Chart.

4.2 Displaying Data as Numerical Values

You can display data in the Numerical Display by copying data saved in the data storage area to an internal device according to the conditions configured with the **Options** tab on the Individual Settings dialog box.

● Copying Data to Internal Devices

Copying Sampling Time Data

Sampling time data is copied as a BCD value to the six sequential devices starting with the device configured by **Destination Device**.

The sampling time data is copied in year, month, day, hour, minute, second order regardless of the **Stored Order of Data** setting.

■ Example

When the sampling time 10/01/2011 12:01:30 is copied to the destination device

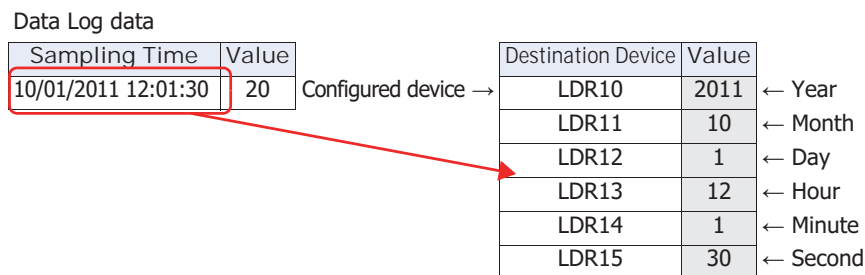

Data Read Start Position and Copy Order of Data to the Destination Device

The data to copy and the order differs according to the **Starting Point** and the **Stored Order of Data** settings.

■ Example 1

Copying three items of the newest data in the Data Log to the destination device

Item	Setting
Destination Device	LDR10
Starting Point	Newest Data
Number of Data	3
Stored Order of Data	From Newest to Oldest

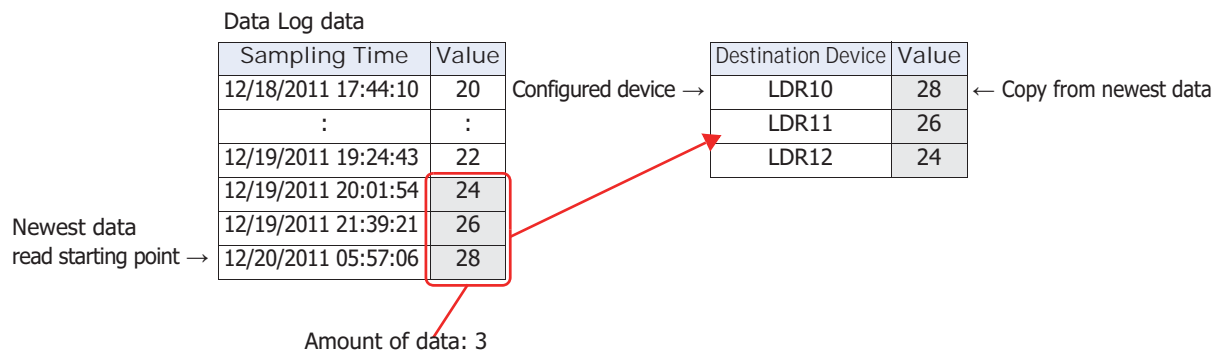

Example 2

Copying three items of the newest data in the Data Log in order from the oldest to the destination device

Item	Setting
Destination Device	LDR10
Starting Point	Newest Data
Number of Data	3
Stored Order of Data	From Oldest to Newest

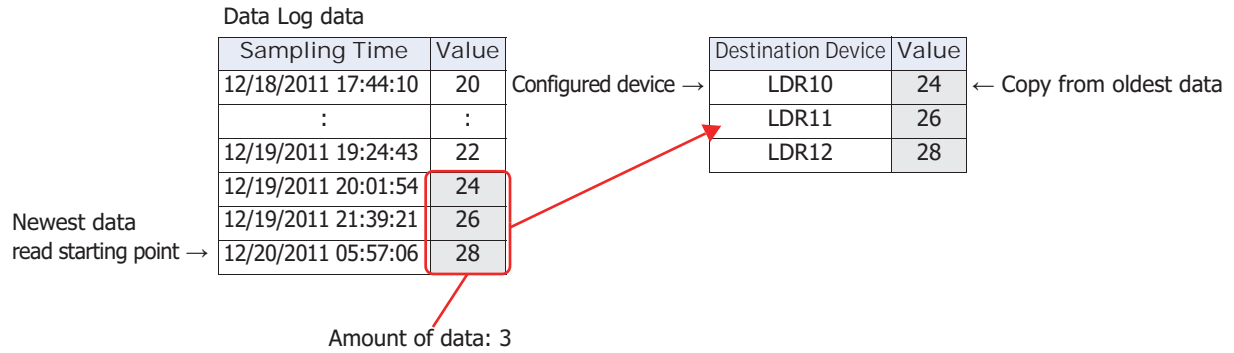

Example 3

Setting the starting point to the fourth item of the oldest data in the Data Log and copying three items of data from the newest to the destination device

Item	Setting
Destination Device	LDR10
Starting Point	Specify by Value of Device (value is 4)
Number of Data	3
Stored Order of Data	From Newest to Oldest

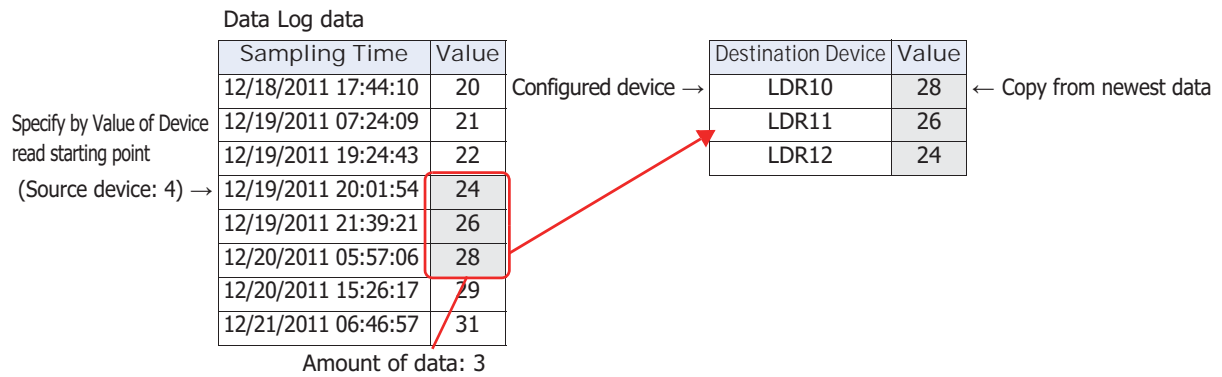

Copying Data when 32-bit is Selected as the Data Size

When **32-bit** is selected for **Data Size** on the **General** tab on the **Individual Settings** dialog box, two destination devices are required for a single item of data.

■ Example 1

Copying the newest data in the Data Log with the data size selected as 32-bit to the destination device LDR 10.

Item	Setting
Destination Device	LDR 10
Starting Point	Newest Data
Number of Data	2
Data Size	32-bit
Stored Order of Data	From Newest to Oldest

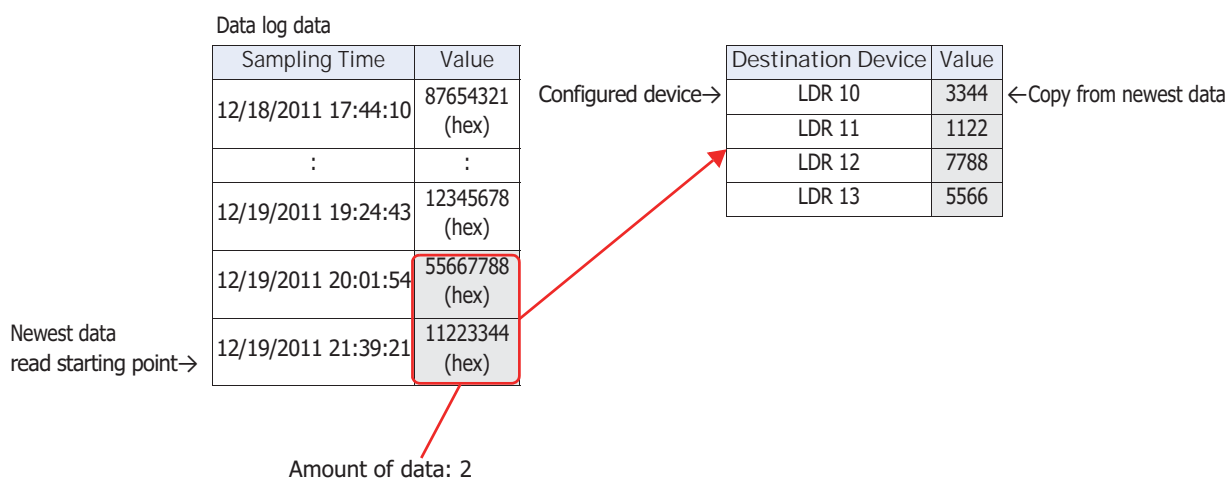

The data copy order for the device selected with a data size of 32-bit is configured on the **Project Settings** dialog box, on the **System** tab, with **Storage Method of 32-bit Numerical Data**. For details, refer to Chapter 3 "3.1 System Tab" on page 3-19.

Copying Multiple Items of Data

When copying multiple items of data, first all the sampling times for the data are copied in order starting with the device configured as the destination device, then the values of devices for all the data are copied in order. For example, data is copied in this order: first sampling time → second sampling time → ... → first data 1 value of device → first data 2 value of device → second data 1 value of device → second data 2 value of device and so on.

■ **Example 1: When the amount of data is greater than the data to copy**

When the sampling time and values of devices from data start number 1 to end number 3 are copied to the destination device as two items of data

Item	Setting
Destination Device	LDR10
Starting Point	Newest Data
Number of Data	2
Stored Order of Data	From Oldest to Newest
Target Data	Sampling Time, Value of Device
	Data No.: Start No. 1, End No. 3

Data Log data

	Sampling Time	Data 1	Data 2	Data 3	Data 4	Data 5
	10/01/2011 12:00:30	10	40	100	20	120
1.	10/01/2011 12:34:56	100	60	240	30	200
2.	10/02/2011 03:45:12	200	80	450	70	400

3. 4. 5.

← Newest Data read starting point

	Destination Device	Value	
Configured device →	LDR10	2011	← Copy from oldest data
	LDR11	10	
	LDR12	01	
1. →	LDR13	12	← First sampling time
	LDR14	34	
	LDR15	56	
	LDR16	2011	
	LDR17	10	
2. →	LDR18	02	← Second sampling time
	LDR19	03	
	LDR20	45	
	LDR21	12	
3. →	LDR22	100	← First data 1 value
	LDR23	200	← Second data 1 value
4. →	LDR24	60	← First data 2 value
	LDR25	80	← Second data 2 value
5. →	LDR26	240	← First data 3 value
	LDR27	450	← Second data 3 value

■ Example 2: When the amount of data is less than the data to copy

When the sampling time and values of devices from data start number 1 to end number 3 are copied to the destination device as two items of data

Item	Setting
Destination Device	LDR10
Starting Point	Newest Data
Number of Data	2
Stored Order of Data	From Oldest to Newest
Target Data	Sampling Time, Value of Device
	Data No.: Start No. 1, End No. 3

Data Log data

	Sampling Time	Data 1	Data 2	Data 3 (no data)
	10/01/2011 12:00:30	10	40	
1.	10/01/2011 12:34:56	100	60	
2.	10/02/2011 03:45:12	200	80	

3. 4.

← Newest Data read starting point

	Destination Device	Value	
Configured device →	LDR10	2011	← Copy from oldest data
	LDR11	10	
	LDR12	01	
	LDR13	12	← First sampling time
1. →	LDR14	34	
	LDR15	56	
	LDR16	2011	
	LDR17	10	
2. →	LDR18	02	← Second sampling time
	LDR19	03	
	LDR20	45	
	LDR21	12	
3. →	LDR22	100	← First data 1 value
	LDR23	200	← Second data 1 value
4. →	LDR24	60	← First data 2 value
	LDR25	80	← Second data 2 value
If the amount of data in the Data Log is less than the data to copy, 0 is stored →	LDR26	0	← First data 3 value
	LDR27	0	← Second data 3 value



When writing with the following settings, "Device range error" is displayed.

- **Starting Point** is 0 or a value larger than the amount of saved data
- **Start No.** is 0 or a value larger than **Data No.**
- **End No.** is 0 or a value larger than **Data No.**
- **Start No.** is a value larger than **End No.**

- **Displaying Data on the Numerical Display**

You can copy sampled data to an internal device and display it with the Numerical Display.

- 1 On the **Configuration** tab, in the **System Setup** group, click **Data Log**.

The Data Log Settings dialog box is displayed.

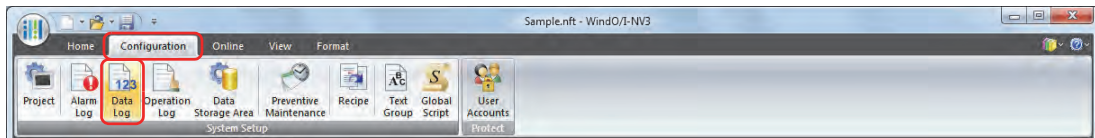

- 2 Click **Advanced**.

The dialog box switches to Advanced mode.

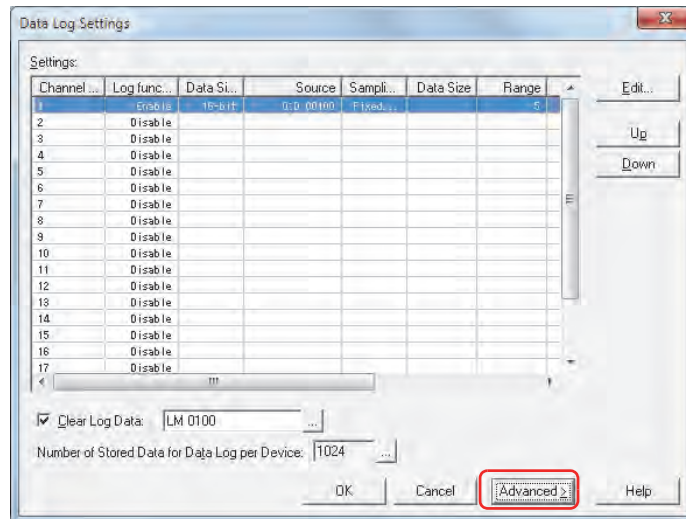

- 3 Under **Settings**, select the channel number for the data to display numerical values of on the Numerical Display, then click **Edit**.

The Individual Settings dialog box is displayed.

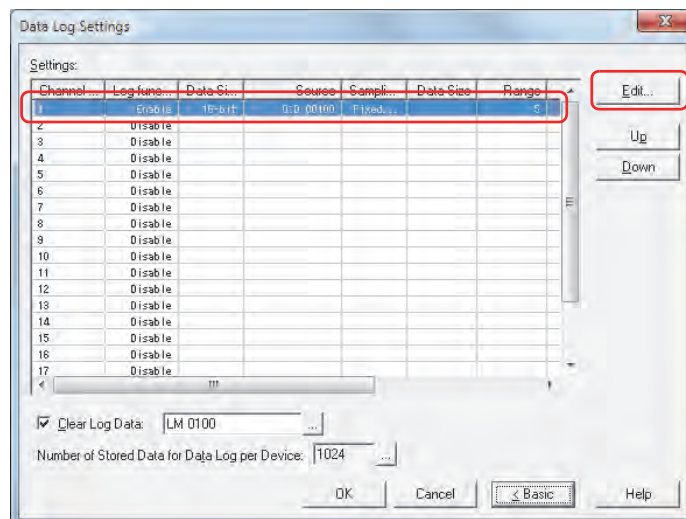

- 4 Select **Enable** for **Log function** on the **General** tab and configure **Data Size**, **Source**, and **Sampling Method**.
- 5 Specify the number of devices to sample in **Number of Data** on the **Data** tab, and configure **Display Type** and **Data Type** for each item of data in **Settings**.
- 6 Click the **Options** tab.

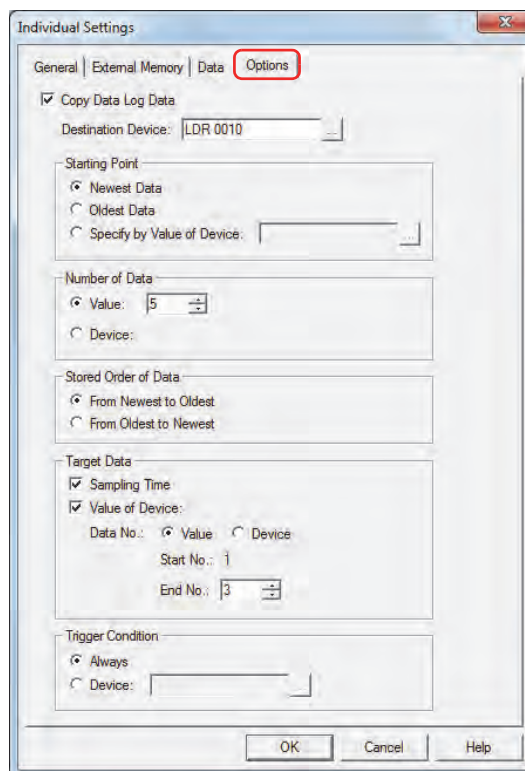

- 7 Select the **Copy Data Log Data** check box.
- 8 Specify the destination device for the copied data in **Destination Device**.

You can only specify an internal device.

Click to display the Device Address Settings dialog box. For the device address configuration procedure, refer to Chapter 2 "5.1 Device Address Settings" on page 2-61.

- 9 Select the data that is the start point for copying data in **Starting Point**.

- **Newest Data**

Set the starting point to read as the newest data.

- **Oldest Data**

Set the starting point to read as the oldest data.

- **Specify by Value of Device**

Specifies which data from the oldest data to set as the starting point to read by value of device, and sets that data as the starting point to read.

Specifies the source word device. You can only specify an internal device.

Click to display the Device Address Settings dialog box. For the device address configuration procedure, refer to Chapter 2 "5.1 Device Address Settings" on page 2-61.

10 Select the specification method for the amount of data to copy in **Number of Data**.**Value**

Use a constant.

Specifies the amount to copy (1 to 64).

Device

Use a word device.

Specifies the source word device. You can only specify an internal device.

Click  to display the Device Address Settings dialog box. For the device address configuration procedure, refer to Chapter 2 "5.1 Device Address Settings" on page 2-61.



The maximum amount of data that can be copied to the internal device is 64.

11 Select the order to copy data in **Stored Order of Data**.**From Newest to Oldest**

Of the data to copy, copies from the start point in order of the newest data first.

From Oldest to Newest

Of the data to copy, copies from the start point in order of the oldest data first.

12 Select the data to copy from the data in **Target Data**.

Select the **Sampling Time** check box to copy the sampling time data from the data.

Select the **Value of Device** check box to copy the value of device from the data. When not copying the value of device, proceed to step **15**.

13 Select the specification method for the data number to copy the value in **Data No.**.**Value**

Use a constant.

Device

Use a word device.

14 Specify the data number of the data to start copying out of the data to copy with **Start No.**.

If you select **Value**, specify the data number (1 to 128).

If you select **Device**, specify the source device. You can only specify an internal device. Click  to display the Device Address Settings dialog box. For the device address configuration procedure, refer to Chapter 2 "5.1 Device Address Settings" on page 2-61.

When the **Sampling Time** check box is selected, the data number is 1. This cannot be changed.

15 Specify the data number of the data to end copying out of the data to copy with **End No.**.

If you select **Value**, specify the data number (1 to 128).

If you select **Device**, specify the source device. You can only specify an internal device. Click  to display the Device Address Settings dialog box. For the device address configuration procedure, refer to Chapter 2 "5.1 Device Address Settings" on page 2-61.

16 Select the condition to start copying in **Trigger Condition**.**Always**

Copies each time the data is updated.

Device

Specifies the device that triggers the start of copying the data. Copies the data when the value of the specified device changes from 0 to 1. Click  to display the Device Address Settings dialog box. For the device address configuration procedure, refer to Chapter 2 "5.1 Device Address Settings" on page 2-61.

17 Click **OK** to close the Individual Settings dialog box.

18 Click **OK** to close the Data Log Settings dialog box.

19 On the **Home** tab, in the **Parts** group, click **Data Displays**, and then click **Numerical Display**.

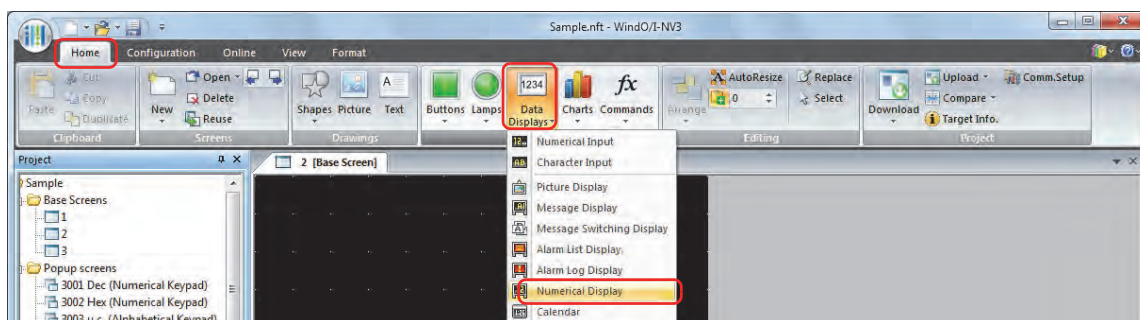

20 Click a point on the edit screen where you want to place the Numerical Display.

21 Double-click the dropped Numerical Display and a Properties dialog box will be displayed.

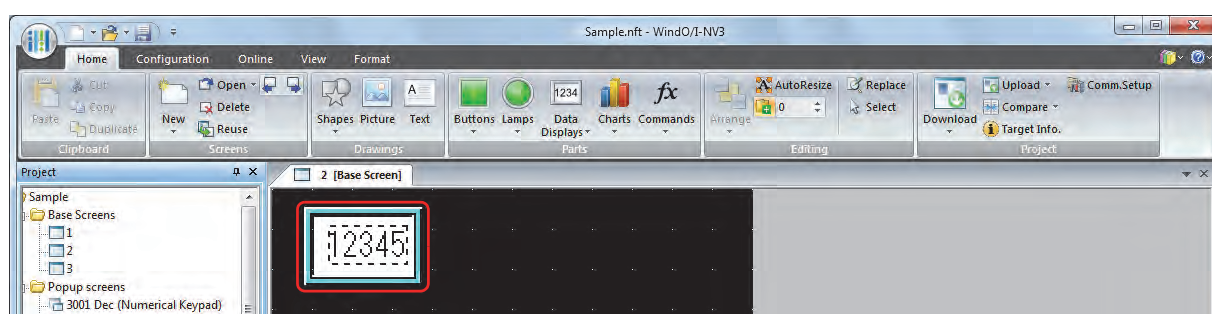

22 Select the display type for the copied data with **Display Type** on the **General** tab.

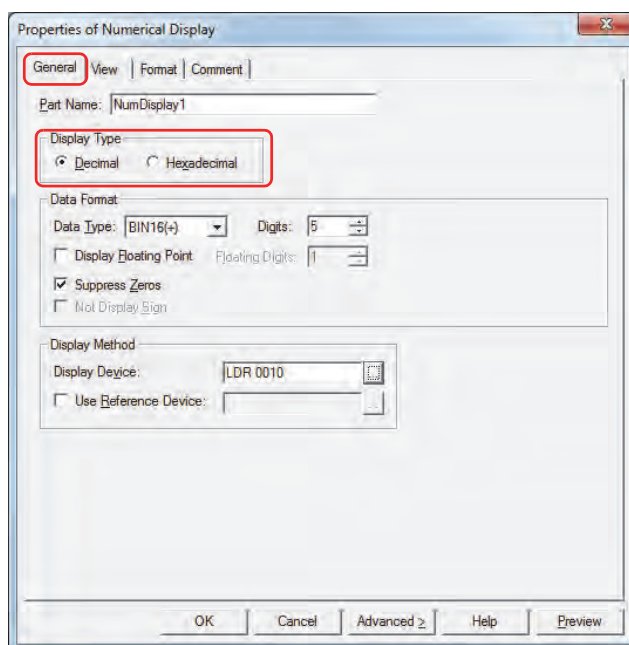

23 Select the data type for the copied data in **Data Type** under **Data Format**.

24 Specify the number of digits to display in **Digits** under **Data Format**.

The range of digits that can be set differs according to the display type and data type.

25 Specify the source device for the copied data in **Display Device** under **Display Method**.

For sequential devices of the amount of data to copy starting with **Destination Device** configured on the **Options** tab on the Data Log Settings Individual Settings dialog box, set **Display Device** for each Numerical Display to those devices.

Example: When **Destination Device** is LDR10, **Number of Data** is 3

Specify three Numerical Displays with **Display Device** specified as LDR10, LDR11 and LDR12

Click  to display the Device Address Settings dialog box. For the device address configuration procedure, refer to Chapter 2 "5.1 Device Address Settings" on page 2-61.

26 Click **OK**.

The Properties dialog box closes.

27 Repeat step **17** through **26** to configure the Numerical Displays for the amount of data to copy.

This concludes configuring the Numerical Display.

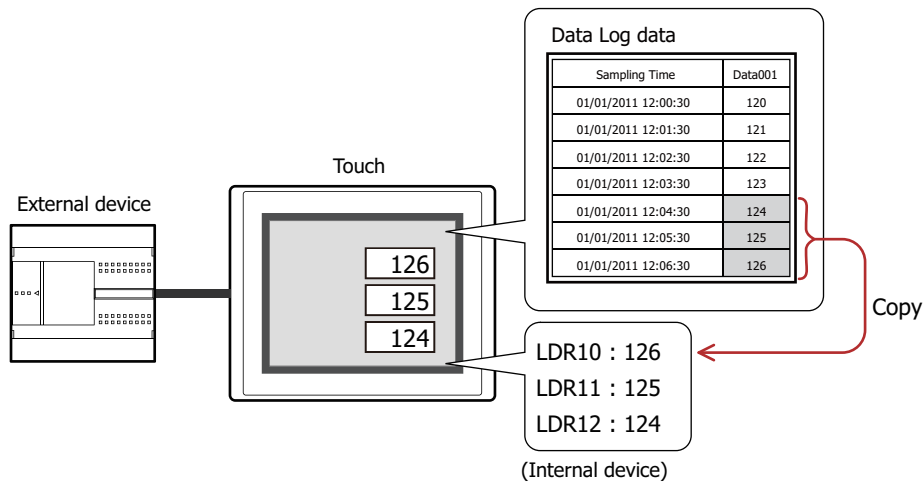

4.3 Saving Data as a CSV File

● Saving Data as a CSV File

The Data Log data can be saved to the external memory as a CSV file.

The procedure to save the data is as follows.

On the WindO/I-NV3 **System Setup** tab, click **Data Log** to display the Data Log Settings dialog box. Select a channel number to save to the external memory, and then click **Edit** to display the Individual Settings dialog box. Select an output method check box on the **External Memory** tab and configure the items. The data can be saved to the External Memory Folder on the external memory. For details, refer to “External Memory Tab” on page 14-16.



Files saved to external memory are read using WindO/I-NV3.

On the WindO/I-NV3 **Online** tab, click the arrow under **Upload**, and then click **Data in external memory** to display the Upload from external memory dialog box. Select the **Data Log Data** check box, specify the location to save the files in **Path**, and then click **OK** to be able to save the files in the specified folder.

● Data Structure and Output Example

The data structure of the output file is as follows. The data structure for files output with batch output and real time output is the same.

Bold items are replaced by the Data Log settings, sampled data, project file name, and WindO/I-NV3 version.

Headers	["Project Name", "Project name", "Version number"
		"File Type", "Log type"
		Blank row
		"Channel No.", "Channel number"
		"Source", "Source device"
		"Sampling Method", "Sampling condition (type)"
		"Sampling condition (label)", "Sampling condition (configuration details)"
Blank row		
Label row	["Label (sampling time)", "Label (data number 1)", "Label (data number 2)"... times the amount of data
Data row	["MM/DD/YYYY HH:MM:SS", Data number 1 data value, Data number 2 data value... times the amount of data
		⋮

Output example

"Project Name", "Dimmer Console", "V1.00"	Data size of each row
"File Type", "Data Log Data"	- 41 bytes
	- 29 bytes
	- 2 bytes
"Channel No.", "1"	- 19 bytes
"Source", "LDR 100"	- 20 bytes
"Sampling Method", "Fixed Period"	- 34 bytes
"Time[Sec]", "1"	- 17 bytes
	- 2 bytes
"Sampling Time", "Data001", "Data002"	- 37 bytes
"08/23/2011 18:32:04", 171,234	- 32 bytes
	⋮



- The data size for each row is counted as two bytes for full-width characters, one byte for characters, and two bytes for newlines. The total for each row is the total amount of space for the file.

- A space is inserted before the year in the data row.

- The display type for the date and time differs according to the language configured in **Project Settings**, on the **Project Details** tab, in **Language**.

Japanese: YYYY/MM/DD HH:MM:SS

European, Chinese, Taiwanese, Korean, Central European, Baltic, Cyrillic: MM/DD/YYYY HH:MM:SS

Chapter 15 Operation Log Function

This chapter describes how to configure the Operation Log function and its operation on the Touch.

1 Overview

1.1 How the Operation Log Function is Used

The Operation Log function records events that have occurred on the Touch, including user operations such as pressing a button or changing the operation mode.

You can perform the following actions using the Operation Log function.

- Record turning on the Touch power

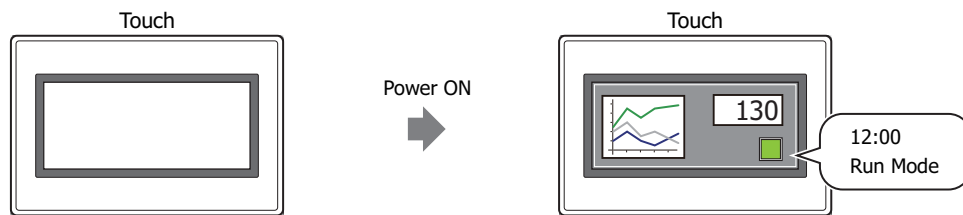

- Record switching the Base Screen

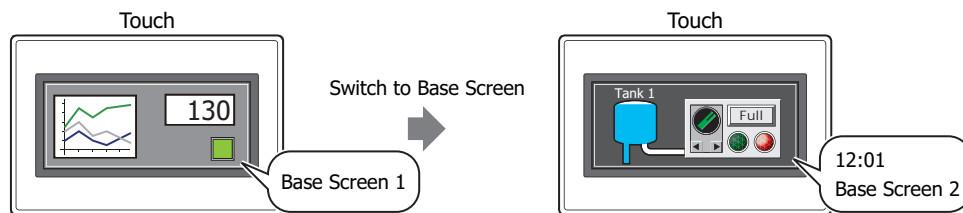

- Record changing the user

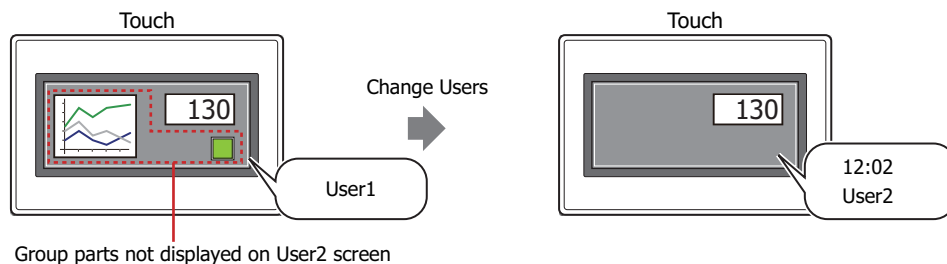

- Record changing the operation mode

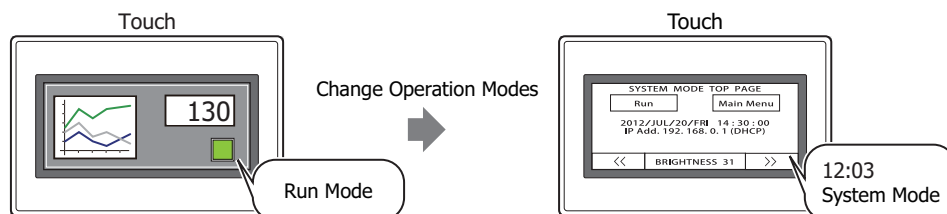

- Record pressing a touch switch

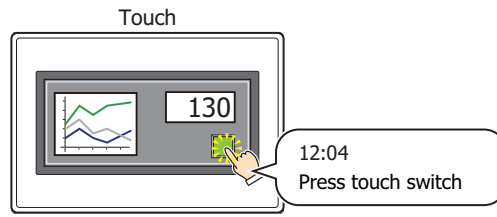

- Record writing a value to a device by pressing a touch switch

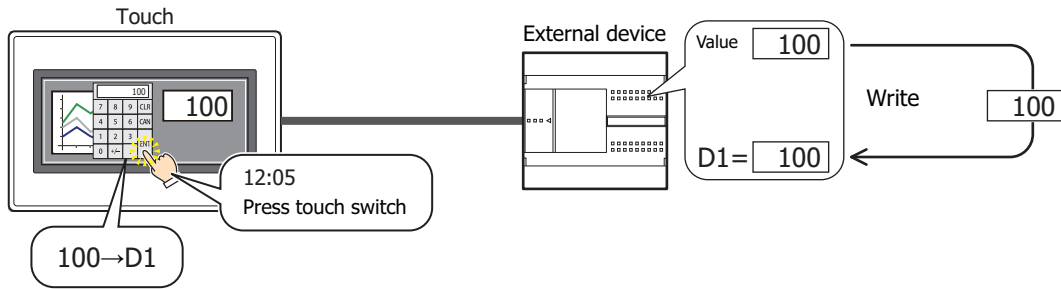

- Output Operation Log data to the external memory

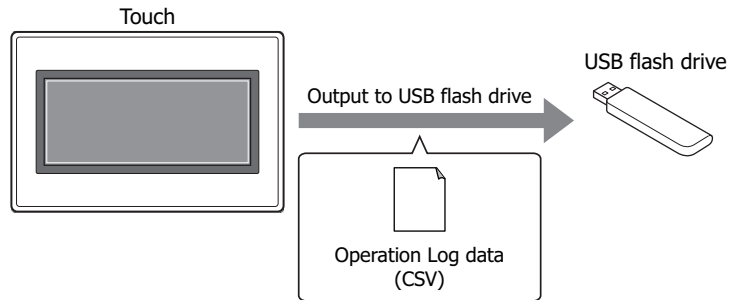

1.2 Recorded Events

The recorded events are as follows.

■ Power ON

This operation is recorded when the Touch power is turned on.

■ Switch to Base Screen

This operation is recorded by the following events.

- Switched the Base Screen by pressing the Goto Screen Button or a Multi-Button
- Switched the Base Screen by pressing the key button **Ref.** on the Alarm List Display or the Alarm Log Display
- Switched the Base Screen by executing the Goto Screen Command or a Multi-Command
- Switched the Base Screen by writing a screen number to System Area 1 Display screen number (address+0)

■ Change Users

This operation is recorded by the following events.

- Switched the user by entering a password on the Password Screen
- Switched the user by writing a value of device
- Switched to the default user



- If User is selected in **Default User** in the User Accounts dialog box, a **Change Users** event occurs when the power is turned on and when the operation mode is changed.
- If the **Switch to Base Screen** check box is selected, a **Switch to Base Screen** event also occurs when a **Change Users** event occurs.

■ Change Operation Modes

This operation is recorded by the following events.

- Switched to System Mode by pressing the Goto Screen Button or a Multi-Button
- Switched to System Mode by executing the Goto Screen Command or a Multi-Command
- Switched to System Mode by pressing **System Mode** on the Maintenance screen
- Switched to Run Mode from System Mode by pressing **Run** on the Top Page in the System Mode
- Switched to Monitor Mode from Run Mode by clicking **Start Monitor** on the WindO/I-NV3 **Online** tab
- Switched to Run Mode from Monitor Mode by clicking **Stop Monitor** on the WindO/I-NV3 **Online** tab



The Operation Log is only recorded during Run Mode.

Switching from Run Mode to System Mode and switching from System Mode to Run Mode is recorded. Switching from System Mode to Data Transfer Mode and switching from Data Transfer Mode to System Mode is not recorded.

■ Press buttons

This operation is recorded by the following events.

- Pressing a Bit Button, Word Button, Goto Screen Button, Multi-Button, Selector Switch, Potentiometer, Numerical Input, Character Input
- Pressing the key buttons **ENT**, **Download Project**, **Upload Project**, **All Chk.**, **Del. All**, **Ref.**, **Stop the Sound of the Buzzer and Screen flashing**



The Operation Log only records touch switch presses for parts created in WindO/I-NV3.

Operations for the following screens and buttons displayed in messages and title bars are not recorded.

- System screen
- Password screen
- System error messages
- Popup screen title bar

■ Write Data to any Devices

This operation is recorded by the following event.

Writing a value to a device by pressing a Bit Button, Word Button, Multi-Button, Selector Switch, Potentiometer, Numerical Input, Character Input

1.3 Data Configuration

The recorded data is composed of a label, time, user name, screen number, event name, part name, device, and content after the change.

The relationship between the Operation Log function settings and the recorded data is as follows.

Operation Log settings

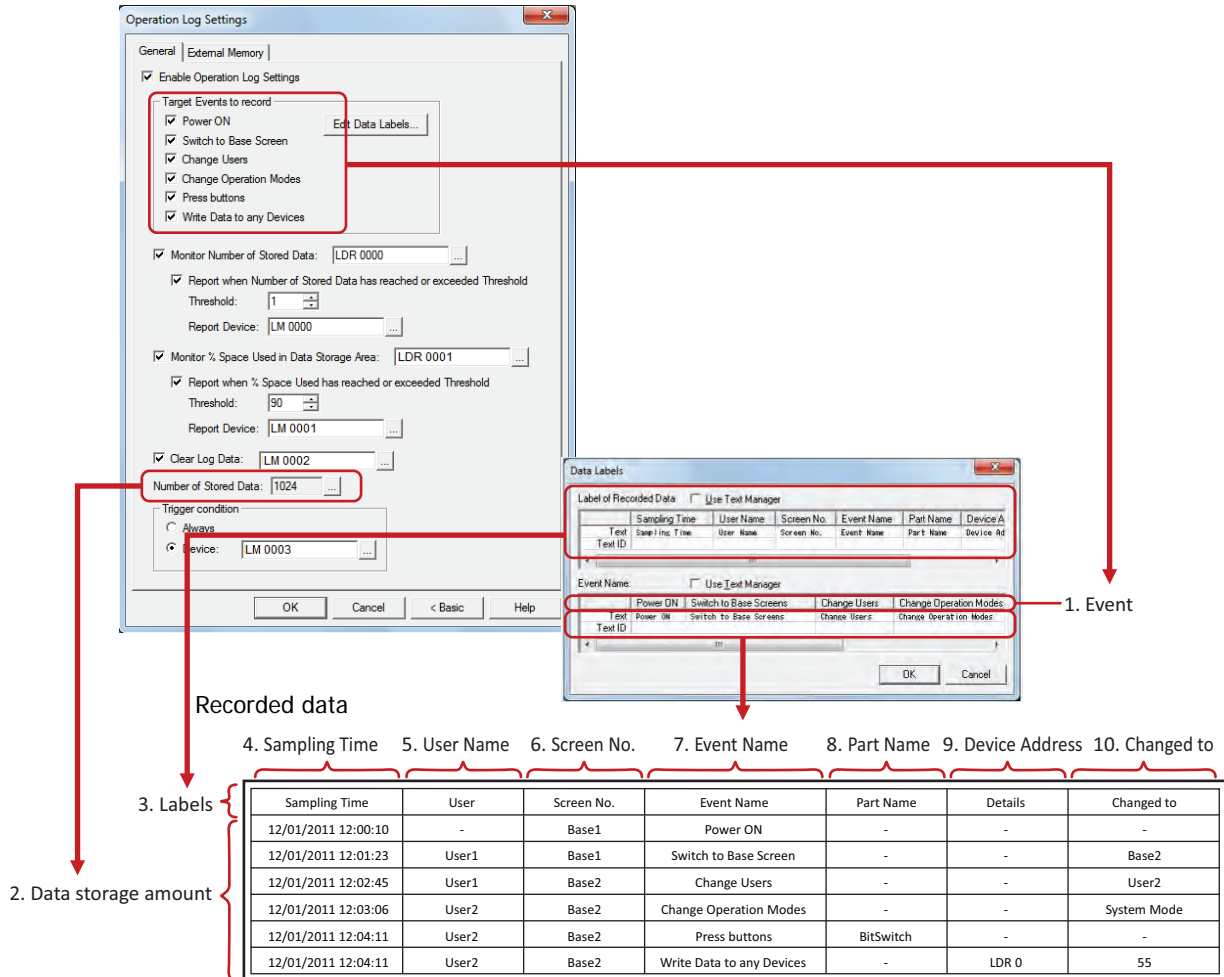

1. Event: Events that occur on the Touch due to operations including user operations. Only the checked events are recorded.
2. Data storage amount: The amount of data to record. For details, refer to "Data Storage Amount" on page 15-6.
3. Label: When the recorded data is output as a CSV file, this is the text displayed in the label row.
4. Sampling Time: The time the event occurred.
The display type for the date and time varies based on the language configured in **Project Settings**, on the **Project Details** tab, in **Language**.
 YYYY/MM/DD Japanese
 HH:MM:SS:
 MM/DD/YYYY European, Chinese, Taiwanese, Korean, Central European, Baltic, Cyrillic
 HH:MM:SS:
5. User Name: The user name when the event occurred.
The user name is only recorded when the **Use Security functions** check box is selected on the **General** tab in the User Accounts dialog box.
6. Screen No.: The screen type and number that was displayed when the event occurred.
 Base *n*: Base Screen (*n*: screen number)
 Example: Base 1
 Popup *n*: Popup Screen (*n*: screen number)
 Example: Popup 10
7. Event Name: When the recorded data is output as a CSV file, this is the text displayed as a label to describe the event that occurred. This item is configured in the Data Labels dialog box.

8. Part Name: The part name for the pressed touch switch when the **Press buttons** event occurs.

9. Device Address: The destination device when the **Write Data to any Devices** event occurs.

When an indirect write is used, the device specified by the indirect value is recorded.

Example: When the device configured as the destination for the value 100 is LDR100 and the indirect value is 3

Event Name	Part Name	Details	Changed to
Press buttons	WordSwitch1	-	-
Write Data to any Devices	-	LDR103	100

10. Changed to: The result produced from the event that occurred. The recorded content varies based on the event that occurred.

Switch to Base Screen: The screen type and number after switching.

Base *n*: Base Screen (*n*: screen number)

Example: Base 1

Change Users: The user name after the change.

Change Operation Modes: The operation mode after the change.

Run Mode: Run Mode

System Mode: System Mode

Monitor Mode: Monitor Mode

Write Data to any Devices: The value written to the device by pressing the touch switch. This value is handled as BIN16 (+). For details, refer to Chapter 2 "1.1 Available Data" on page 2-1.

The value written to the device is recorded as BIN16 (+) regardless of the data type.

Example: When -10 (0xFFFF6) is written to device D0

Event Name	Part Name	Details	Changed to
Press buttons	WordSwitch1	-	-
Write Data to any Devices	-	D0	65526 (0xFFFF6)

If the written value is 2 words (32 bits), each word is recorded (16 bits). For the storage order for 32-bit device data, the upper word and lower word are stored following the **Storage Method of 32-bit Numerical Data** setting. **Storage Method of 32-bit Numerical Data** is configured on the **System** tab in the Project Settings dialog box. For details, refer to Chapter 3 "3.1 System Tab" on page 3-19.

Example: When **Storage Method of 32-bit Numerical Data** is from **Lower word** and 12345678 (0xBC614E) is written to device D0 with the data type BIN32 (+)

Event Name	Part Name	Details	Changed to
Press buttons	WordSwitch1	-	-
Write Data to any Devices	-	D0	24910 (0x614E)
Write Data to any Devices	-	D1	188 (0xBC)

1.4 Saving and Deleting Data

● Saving Data

The recorded data is saved in the data storage area.

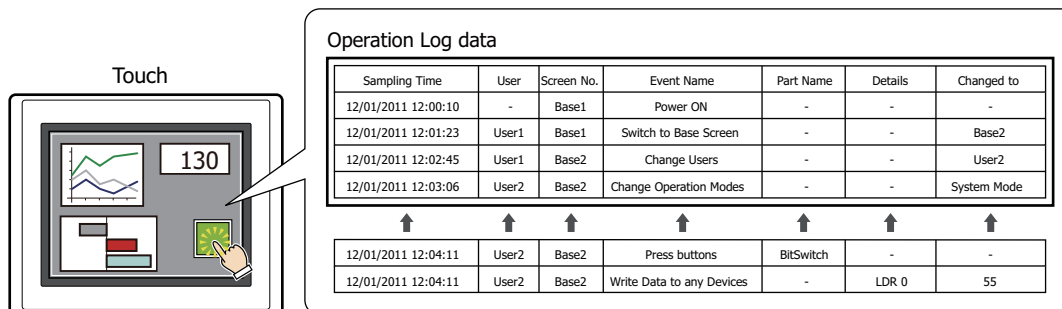

If the saved data exceeds the Operation Log data storage amount, the oldest data is deleted and the new data is saved.

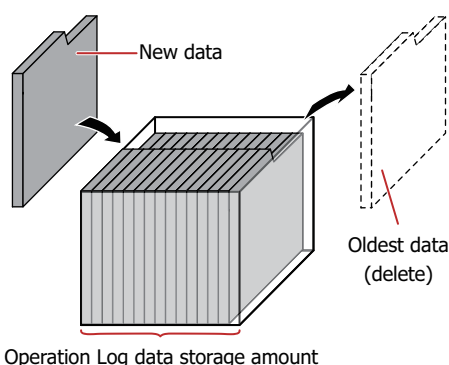

When the backup battery is depleted, the data in the Operation Log is erased when the Touch is turned off.

Data Storage Amount

The maximum amount of data that can be saved in the data storage area is 3579.



The maximum amount of data that can be recorded by a single operation is 150 items. When writing to multiple devices in a single operation using the Multi-Button or other part, data over 150 items cannot be recorded. If the data to be recorded in a single operation exceeds 150 items, HMI Special Internal Relay LSM22 is set to 1. For details, refer to Chapter 27 "HMI Special Internal Relay (LSM)" on page 27-1.

● Deleting Data

The method to delete recorded data from the data storage area is as follows.

- On the WindO/I-NV3 **Online** tab, click the arrow under **Clear**, and then click **All** or **Operation Log Data**. For details, refer to Chapter 23 "4 Clear" on page 23-22.
- On the Top Page in the System Mode, press **Main Menu**, **Initial Setting**, **Initialize**, and **Opn Log** in order.

1.5 Using the Data

The saved data can be used in the following ways.

Operation Log data

Sampling Time	User	Screen No.	Event Name	Part Name	Details	Changed to
12/01/2011 12:00:10	-	Base1	Power ON	-	-	-
12/01/2011 12:01:23	User1	Base1	Switch to Base Screen	-	-	Base2
12/01/2011 12:02:45	User1	Base2	Change Users	-	-	User2
12/01/2011 12:03:06	User2	Base2	Change Operation Modes	-	-	System Mode
12/01/2011 12:04:11	User2	Base2	Press buttons	BitSwitch	-	-
12/01/2011 12:04:11	User2	Base2	Write Data to any Devices	-	LDR 0	55



- Save to and read from an external memory
 Operation log data is saved in a CSV file format into the external memory which it can be read on your computer. For details, refer to “4.1 Saving the Data as a CSV File” on page 15-17.

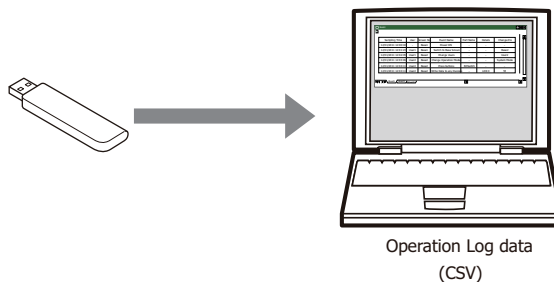

2 Operation Log Function Configuration Procedure

This section describes the configuration procedure for the Operation Log function.

2.1 Configuring the Events and the Condition for Recording

- 1 On the **Configuration** tab, in the **System Setup** group, click **Operation Log**.

The Operation Log Settings dialog box is displayed.

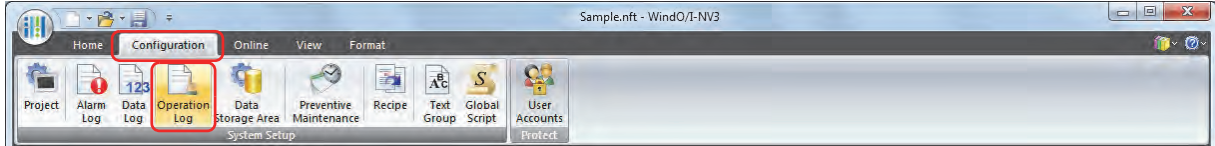

- 2 Select the **Enable Operation Log Settings** check box.

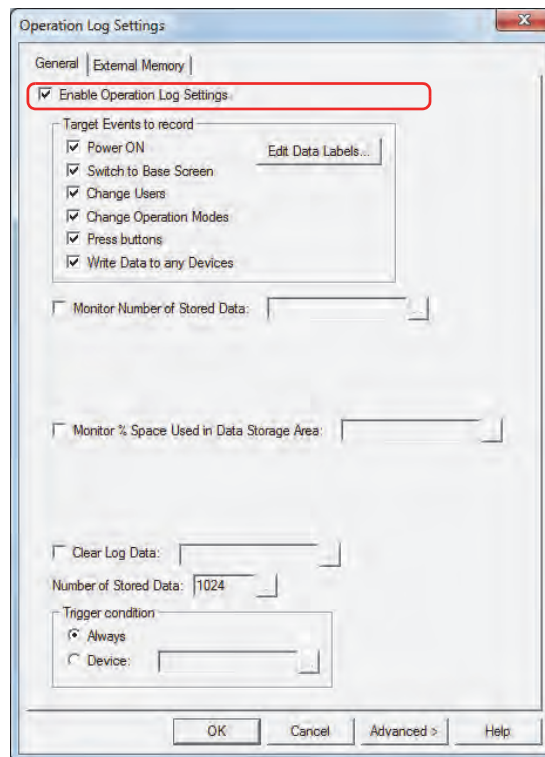

- 3 Select the check boxes for the events to record under **Target Events to record**.

Power ON:	The following items are recorded when the Touch power is turned on. Time, screen number, event name
Switch to Base Screen:	The following items are recorded when the Base Screen is switched. Time, user name, screen number, event name, changed to
Change Users:	The following items are recorded when the user is changed. Time, user name, screen number, event name, changed to
Change Operation Modes:	The following items are recorded when the operation mode is changed. Time, user name, screen number, event name, changed to
Press buttons:	The following items are recorded when a touch switch is pressed. Time, user name, screen number, event name, part name
Write Data to any Devices:	The following items are recorded when a value is written to a device by pressing a touch switch. Time, user name, screen number, event name, device, changed to

4 Configure the Operation Log data storage amount in **Number of Stored Data**.

Click  to display the Data Storage Area Management dialog box.

Specify the Operation Log data storage amount in **Number of Stored Data for Operation Log**, and then click **OK**.
The Data Storage Area Management dialog box closes.

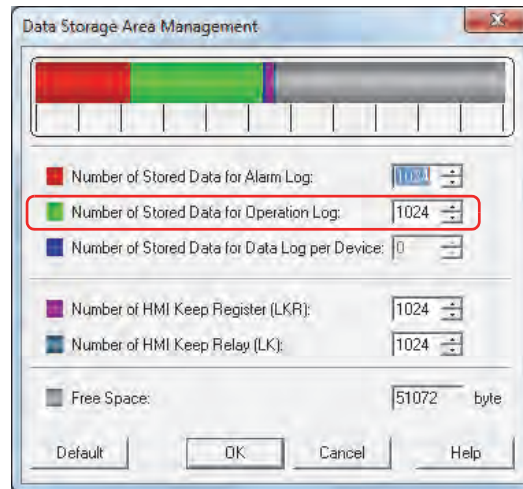

5 Select the condition to record events in **Trigger condition**.

■ **Always**

Always records events.

■ **Device**

Records events when the specified device is 1. You can only specify an internal device.

For the device address configuration procedure, refer to Chapter 2 "5.1 Device Address Settings" on page 2-61.

6 Click **OK**.

The Operation Log Settings dialog box closes.

This concludes configuring the events and the condition for recording.

3 Operation Log Settings Dialog Box

This section describes items and buttons on the Operation Log Settings dialog box.

3.1 Operation Log Settings Dialog Box

● General Tab

The **General** tab is used to configure the events and the condition for recording.

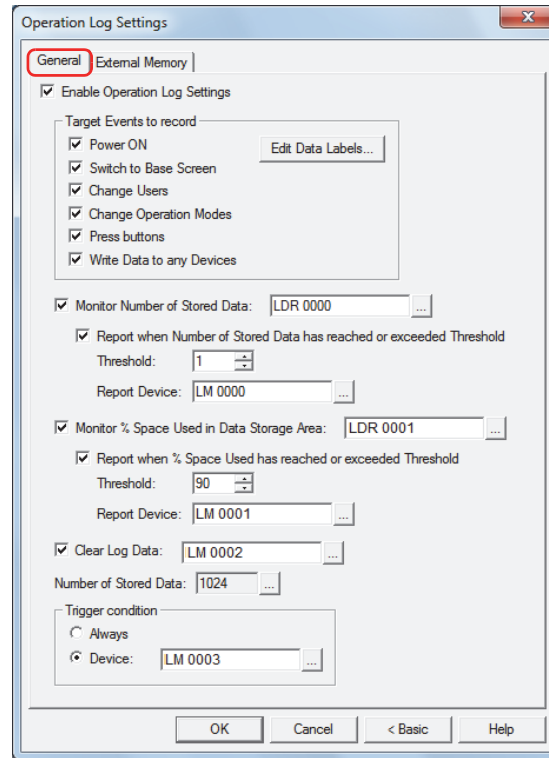

■ Enable Operation Log Settings

Select this check box to use the Operation Log function.

■ Target Events to record

Selects the events to record. Select the check boxes for the events to record.

Power ON:	The following items are recorded when the Touch power is turned on. Time, screen number, event name
Switch to Base Screen:	The following items are recorded when the Base Screen is switched. Time, user name, screen number, event name, changed to
Change Users:	The following items are recorded when the user is changed. Time, user name, screen number, event name, changed to
Change Operation Modes:	The following items are recorded when the operation mode is changed. Time, user name, screen number, event name, changed to
Press buttons:	The following items are recorded when a touch switch is pressed. Time, user name, screen number, event name, part name
Write Data to any Devices:	The following items are recorded when a value is written to a device by pressing a touch switch. Time, user name, screen number, event name, device, changed to
Edit Data Labels:	Displays the Data Labels dialog box. The Data Labels dialog box is used to edit the text displayed in the label row and the event names displayed in the data rows when the recorded data is output as a CSV file. For details, refer to "Data Labels Dialog Box" on page 15-12.

■ Monitor Number of Stored Data

Select this check box to count the amount of recorded Operation Log data. The amount of recorded data is written to the specified device.

(Destination Device): Specifies the destination word device.

For the device address configuration procedure, refer to Chapter 2 "5.1 Device Address Settings" on page 2-61.

Report when Number of Stored Data has reached or exceeded Threshold^{*1}:

Writes 1 to the report device when the current amount of data reaches or exceeds the set threshold.

Threshold^{*1}: Specifies the amount of data (1 to 3579) that is the basis for reporting.

Report Device^{*1}: Specifies the destination bit device or the bit of the destination word device.

For the device address configuration procedure, refer to Chapter 2 "5.1 Device Address Settings" on page 2-61.

■ Monitor % Space Used in Data Storage Area

Select this check box to monitor the usage of the data storage area allocated as the save destination for Operation Log data. The usage is calculated from the data storage amount allocated to the data storage area and the amount of saved data, and then written to the specified device.

Usage = Current amount of Operation Log data ÷ Operation Log data storage amount (omits values after the decimal point)

(Destination Device): Specifies the destination word device to write the current usage of the amount of Operation Log data storage.

For the device address configuration procedure, refer to Chapter 2 "5.1 Device Address Settings" on page 2-61.

Report when % Space Used has reached or exceeded Threshold^{*1}:

Writes 1 in the report device when the current usage reaches or exceeds the set threshold.

Threshold^{*1}: Specifies the usage (1 to 100) that is the basis for reporting.

Report Device^{*1}: Specifies the destination bit device or the bit of the destination word device.

For the device address configuration procedure, refer to Chapter 2 "5.1 Device Address Settings" on page 2-61.

■ Clear Log Data

Select this check box to erase the Operation Log data saved in the data storage area.

(Trigger Device): Specifies the bit device that triggers the erasure of the data. The saved data is erased when the value of the configured device changes from 0 to 1. For the device address configuration procedure, refer to Chapter 2 "5.1 Device Address Settings" on page 2-61.

■ Number of Stored Data

Shows the maximum amount of Operation Log data to save in the data storage area. Data is saved up to the set amount. The maximum amount of data that can be saved in the data storage area is 3579.

Click  to open the Data Storage Area Management dialog box where you can change the allocation of data storage area memory. For details, refer to Chapter 16 "Data Storage Area" on page 16-1.

■ Trigger Condition

Selects the trigger condition for the Operation Log function.

Always: Always records events.

Device: Records events when the specified device is 1. You can only specify an internal device.

For the device address configuration procedure, refer to Chapter 2 "5.1 Device Address Settings" on page 2-61.

*1 Advanced mode only

Data Labels Dialog Box

The Data Labels dialog box is where you can edit labels for recorded data and event names when saving data as a CSV file.

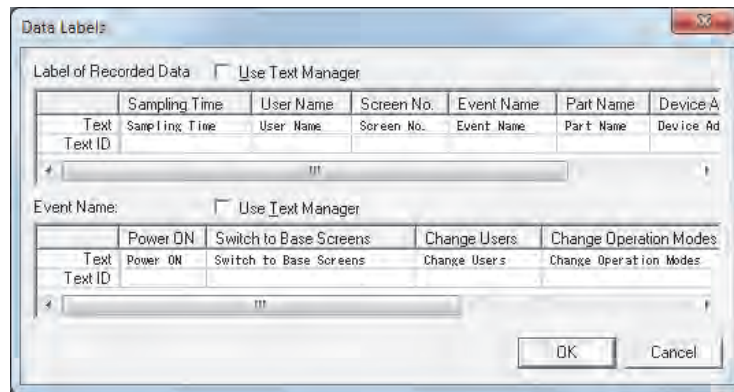

Label of Recorded Data

■ Use Text Manager

Select this check box to use text registered in Text Manager for recorded data labels when saving data as a CSV file.

■ Label of Recorded Data

Specifies the text to display in the label row in **Text** or **Text ID**.

Text: Double click the cell to enter the text to display as the label. The maximum number is 40 characters.

Text can only be entered when the **Use Text Manager** check box is cleared.

Text ID: Double click the cell to specify the Text Manager ID number (1 to 32000) when using text registered in Text Manager as the label.

This option is only enabled if you select the **Use Text Manager** check box.

The details for each label row label is as follows.

Sampling Time: The label for the column to display the time the event occurred.

User Name: The label for the column to display the user name when the event occurred.

Screen No.: The label for the column to display the screen type and number that was displayed when the event occurred.

Event Name: The label for the column to display the name of the event that occurred on the Touch by an operation including a user operation.

Part Name: The label for the column to display the part name for the pressed touch switch when the **Press buttons** event occurs.

Device Address: The label for the column to display the destination device when the **Write Data to any Devices** event occurs.

Changed to: The label for the column to display the result produced from the event that occurred. The recorded content varies based on the event that occurred.

Event Name

■ Use Text Manager

Select this check box to use text registered in Text Manager for the event names when saving data as a CSV file.

■ Event Name

Specifies the text to display in Event Name in **Text** or **Text ID**.

Text: Double click the cell to enter the text to display as the event name. The maximum number is 40 characters.

Text can only be entered when the **Use Text Manager** check box is cleared.

Text ID: Double click the cell to specify the Text Manager ID number (1 to 32000) when using text registered in Text Manager as the event name.

This option is only enabled if you select the **Use Text Manager** check box.

Event name details are as follows.

Power ON: The event name when the Touch power is turned on.

Switch to Base Screens: The event name when the base screen is switched.

Change Users: The event name when the user is changed.

Change Operation Modes: The event name when the Touch operation mode is changed.

Press buttons: The event name when a touch switch is pressed.

Write Data to any Devices: The event name when a value is written to a device by pressing a touch switch.

● External Memory Tab

The **External Memory** tab is used to configure whether or not to output saved data to the external memory.

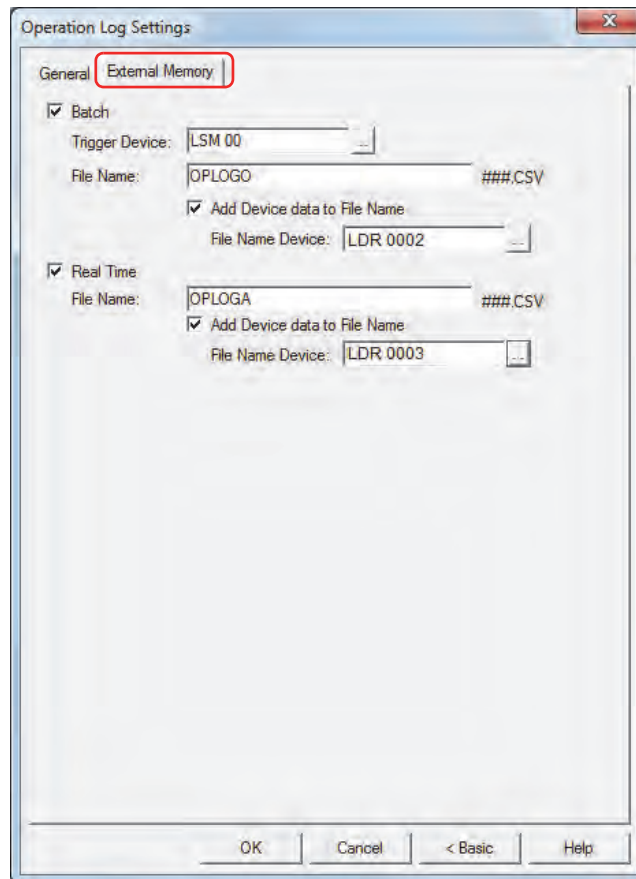

The output data is stored in the following folder on the external memory.

\\External memory folder\OPERATIONLOG

The default External Memory Folder name is "HGDATA01". For details, refer to Chapter 26 "1.5 Setting the External Memory Folder" on page 26-12.



Data recorded after starting output to the external memory is not included in the output data.

■ Batch

Select this check box to batch output all the sampled data to the external memory.

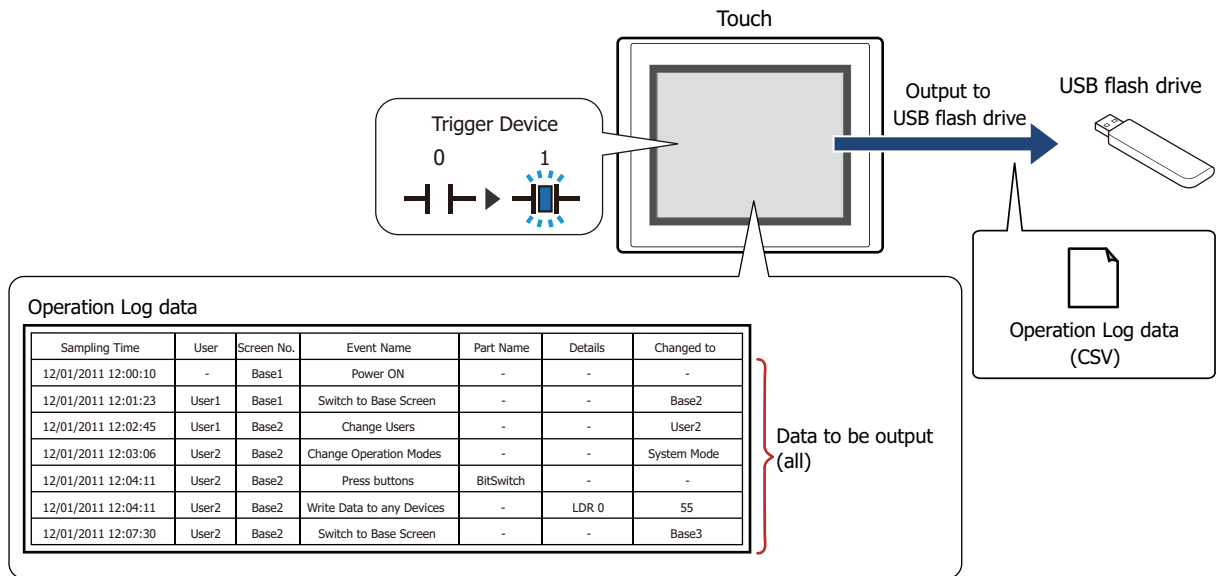

All the data is saved on the external memory when the trigger device changes from 0 to 1. If a file with the same name already exists on the external memory, that file is overwritten. The maximum amount of output data is the amount configured by the data storage area.



Output stops if there is insufficient free space on the external memory. USB flash drive error information is stored in HMI Special Data Register LSD33.

Trigger Device: Specifies the bit device that triggers batch output. For the device address configuration procedure, refer to Chapter 2 “5.1 Device Address Settings” on page 2-61.
Data is output to file when the trigger device changes from 0 to 1.

File Name: Enter the file name for the output data or shows the file name.
The default is “OPLOGO.CSV”.
To change the file name, enter a new file name. The maximum number is 120 characters (including the extension).

Add Device data to File Name*1: Select this check box to add the bottom three digits of the value of device configured by **File Name Device** to the end of the file name for the output data.

Example: When the value of device configured by **File Name Device** is 123, the file name is “OPLOGO123.CSV”.

File Name Device: Specifies the word device that is the source for the value to add to the file name. For the device address configuration procedure, refer to Chapter 2 “5.1 Device Address Settings” on page 2-61. This option can only be configured when the **Add Device data to File Name** check box is selected.

*1 Advanced mode only

■ Real Time

Select this check box to output data to the external memory in real time.

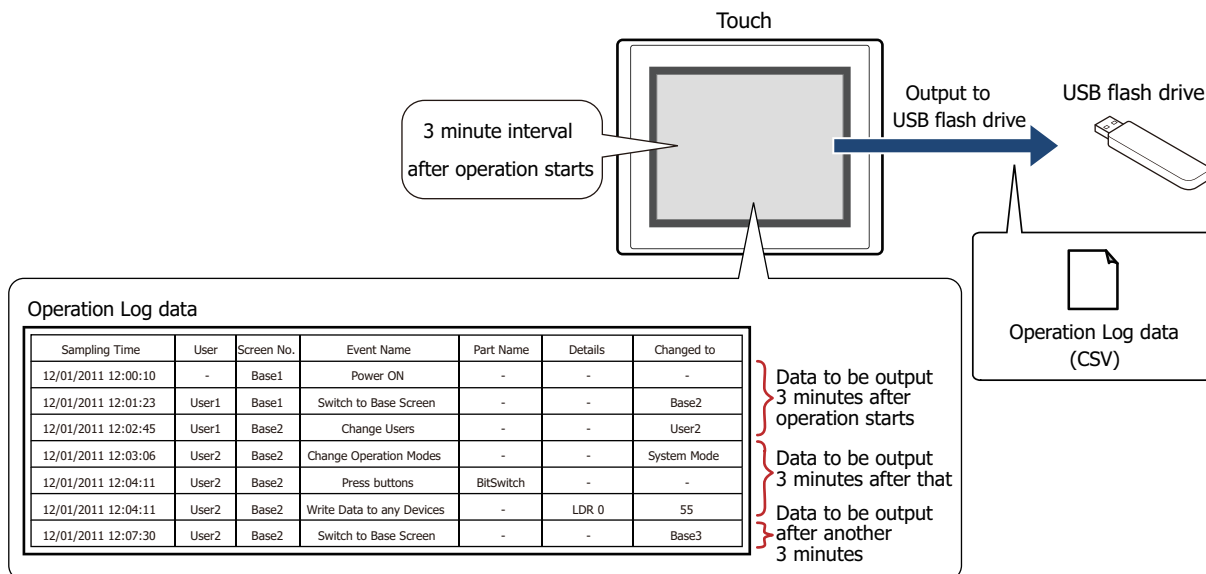

With real time output, data is saved to the external memory in three minute intervals after the Touch starts running. When there is already data with the same file name on the external memory, data is appended to that file. If there was no update to the data during the three minutes, it is not output.

Data is appended to the file until the size of the file reaches the restriction size (256 MB), so the maximum amount of output data varies based on the settings for the output channel such as the amount of data, the data size, and the labels.

If the interval events occur more quickly than the time it takes to accomplish the real time output (the interval for writing to the external memory), the Operation Log is recorded up to the data storage amount - 1, and then afterwards, old data is discarded in order and replaced with new data.



Real time output stops when the file size of the Operation Log data exceeds 256 MB or when there is insufficient space on the external memory. USB flash drive error information is stored in HMI Special Data Register LSD33.



- When the value of HMI Special Internal Relay LSM18 changes from 0 to 1, the data at that time is first output in real time to the USB flash drive, and then access to the USB flash drive is stopped.
- You can check the free space on the USB flash drive with HMI Special Data Registers LSD34 and 35.

File Name: Enter the file name for the output data or shows the file name.

The default is "OPLOGA.CSV".

To change the file name, enter a new file name. The maximum number is 120 characters (including the extension).

Add Device data to File Name*1:

Select this check box to add the bottom three digits of the value of device configured by **File Name Device** to the end of the file name for the output data.

Example: When the value of device configured by **File Name Device** is 123, the file name is "OPLOGA123.CSV".

File Name Device:

Specifies the word device that is the source for the value to add to the file name. For the device address configuration procedure, refer to Chapter 2 "5.1 Device Address Settings" on page 2-61. This option can only be configured when the **Add Device data to File Name** check box is selected.



- The function to record data operates when Operation Log data is being saved to the external memory.
- The methods to erase Operation Log files saved on the external memory are as follows.
 - To erase files during operation using parts, on the **External Memory** tab in the Project Settings dialog box, select the **Remove Files stored in External Memory** check box and the **All Operation Log data** check box, and then configure the trigger device. Assign that trigger device to a part.
 - To erase files with WindO/I-NV3, click **Clear** on the **Online** tab, and then click **Stored Data in External Memory** to open the Clear Data dialog box. Select the **Operation Log Data** check box, and then click **OK**.

*1 Advanced mode only

4 Using the Data

4.1 Saving the Data as a CSV File

● Saving the Data as a CSV File

The Operation Log data can be saved to the external memory as a CSV file.

The procedure to save the data is as follows.

On the WindO/I-NV3 **Configuration** tab, click **Operation Log** to display the Operation Log Settings dialog box. Select an output method check box on the **External Memory** tab and configure the items. The Operation Log data is saved to the External Memory Folder on the external memory according to the **External Memory** tab settings. For details, refer to "External Memory Tab" on page 15-14.



Files saved to external memory are read using WindO/I-NV3.

On the WindO/I-NV3 **Online** tab, click the arrow under **Upload**, and then click **Data in external memory** to display the Upload from external memory dialog box. Select the **Operation Log Data** check box, specify the location to save the files in **Path**, and then click **OK** to be able to save the files in the specified folder.

● Data Structure and Output Example

The data structure of the output file is as follows. The data structure for files output with batch output and real time output is the same.

Bold items are replaced by the Operation Log settings, recorded data, project file name, and WindO/I-NV3 version.

Headers	"Project Name", " Project name ", " Version number "
	"File Type", " Log type "
	Blank row
Label row	" Sampling Time ", " User Name ", " Screen No. ", " Event Name ", " Part Name ", " Device Address ", " Changed to "
Data row	" MM/DD/YYYY HH:MM:SS ", " User Name ", " Screen Type & No. ", " Event ", " Part Name ", " Device Address ", " Changed to "
	⋮

Output example

	Data size of each row
"Project Name", "Dimmer Console", "V1.00"	- 41 bytes
"File Type", "Operation Log Data"	- 34 bytes
	- 2 bytes
"Sampling Time", "User", "Screen No.", "Operation", "Part Name", "Details", "Changed to"	- 84 bytes
" 12/01/2011 12:00:10", "-", "Base 1", "Power ON", "-", "-", "-"	- 60 bytes
" 12/01/2011 12:01:23", "User1", "Base 1", "Switch to Base Screen", "-", "-", "Base2"	- 81 bytes
⋮	



- The data size for each row is counted as 2 bytes for full-width characters, one byte for half-width characters, and two bytes for newlines. The total for each row is the total amount of space for the file.
- A space is inserted before the date in the data row.
- The display type for the date and time varies based on the language configured in **Project Settings**, on the **Project Details** tab, in **Language**.
 - Japanese: YYYY/MM/DD HH:MM:SS
 - European, Chinese, Taiwanese, Korean, Central European, Baltic, Cyrillic: MM/DD/YYYY HH:MM:SS

Chapter 16 Data Storage Area

This chapter describes how to configure the data storage area and its operation on the Touch.

1 Overview

1.1 What is the Data Storage Area?

The data storage area is the area in the Touch's internal memory where saved data is not erased even when the power is turned off. The HMI Keep Registers (LKR) and the HMI Keep Relays (LK) are allocated in this area. The following data can be saved in the data storage area.

- Alarm Log data
☞ Chapter 13 "Alarm Log Function" on page 13-1
- Data Log data
☞ Chapter 14 "Data Log Function" on page 14-1
- Operation Log data
☞ Chapter 15 "Operation Log Function" on page 15-1



- When there is no remaining battery power, the data in the data storage area is erased when the Touch is turned off.
- If you download the project data from WindO/I-NV3, the Alarm Log data, Operation Log data, and Data Log data stored in internal memory are erased, and all internal devices are reset except for the HMI Keep Registers (LKR) and the HMI Keep Relays (LK).

1.2 Data Storage Area

- Data Storage Area Capacity and Types of Storable Data

You can allocate areas to save Alarm Log data, Operation Log data, and Data Log data, as well as areas to use as HMI Keep Registers (LKR) and HMI Keep Relays (LK). The unallocated leftover area is free space.

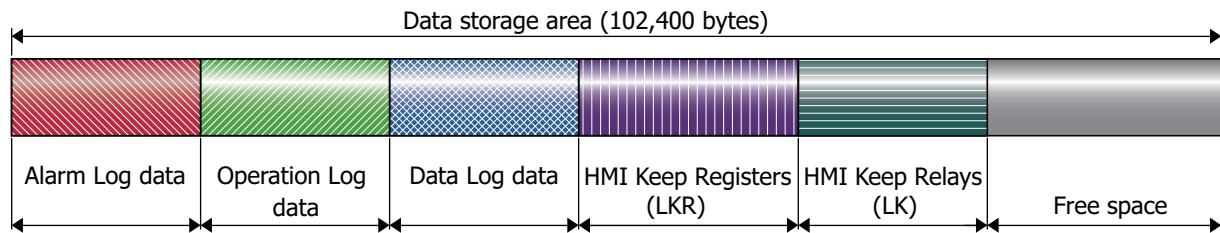

- Minimum and Maximum Amount of Data Storage and Number of Addresses

The minimum and maximum amount of data storage and the minimum and maximum number of addresses that can be configured for the data storage area is as follows.

Data type	Minimum	Maximum
Number of Stored Data for Alarm Log	0	5,011
Number of Stored Data for Operation Log	0	3,579
Number of Stored Data for Data Log per Device	0	12,528
Number of HMI Keep Register (LKR)	1,024	8,192
Number of HMI Keep Relay (LK)	1,024	8,192

2 Data Storage Area Configuration Procedure

This section describes the configuration procedure for the data storage area.

- 1 On the **Configuration** tab, in the **System Setup** group, click **Data Storage Area**.

The Data Storage Area Management dialog box is displayed.

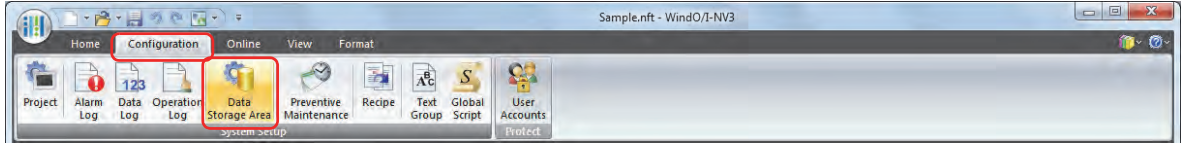

- 2 Specify the amount of Alarm Log data to save in the data storage area in **Number of Stored Data for Alarm Log** (0 to 5011).

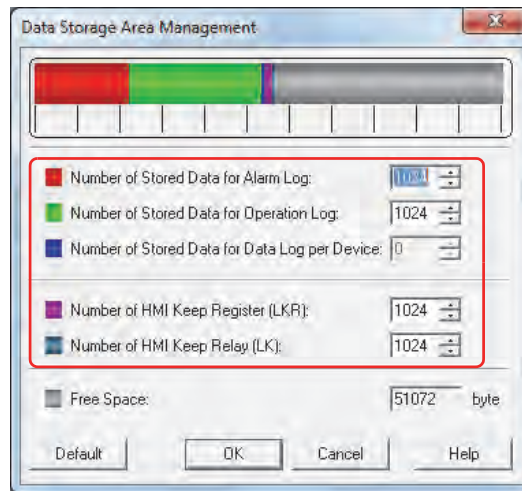

- 3 Specify the amount of Operation Log data to save in the data storage area in **Number of Stored Data for Operation Log** (0 to 3579).
- 4 Specify the amount of Data Log data per device to save in the data storage area in **Number of Stored Data for Data Log per Device** (0 to 12528).
- 5 Specify the number of HMI Keep Register (LKR) addresses in **Number of HMI Keep Register (LKR)** (1024 to 8192).
- 6 Specify the number of HMI Keep Relay (LK) addresses in **Number of HMI Keep Relay (LK)** (1024 to 8192).
- 7 Click **OK**.

The Data Storage Area Management dialog box closes.

This concludes configuring the data storage area.

3 Data Storage Area Management Dialog Box

This section describes items and buttons on the **Data Storage Area Management** dialog box.

3.1 Data Storage Area Management Dialog Box

The areas to save Alarm Log data, Operation Log data, and Data Log data and the areas to use as HMI Keep Registers (LKR) and HMI Keep Relays (LK) are allocated in the Data Storage Area Management dialog box.

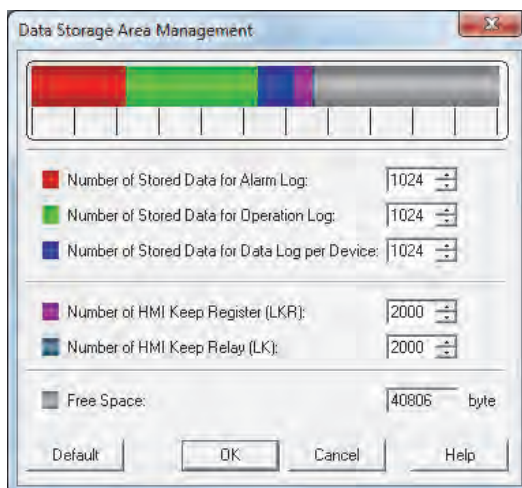

- **Number of Stored Data for Alarm Log**

Specifies the amount of Alarm Log data to save in the data storage area (0 to 5011).

Alarm Log data is only saved in the data storage area when **Store** is selected under **Block Settings, Data** in the Auto-Setup dialog box or in the Individual Settings dialog box for Alarm Log Settings.

- **Number of Stored Data for Operation Log**

Specifies the amount of Operation Log data to save in the data storage area (0 to 3579).

- **Number of Stored Data for Data Log per Device**

Specifies the amount of Data Log data per device to save in the data storage area (0 to 12528).

Data Log data is only saved in the data storage area when **Enable** is selected under **Log function** on the **General** Tab in the Individual Settings dialog box for Data Log Settings.

- **Number of HMI Keep Register (LKR)**

Specifies the number of HMI Keep Register (LKR) addresses (1024 to 8192).

- **Number of HMI Keep Relay (LK)**

Specifies the number of HMI Keep Relay (LK) addresses (1024 to 8192).

- **Free Space**

Shows the amount of free space in the data storage area (in bytes).

- **Default**

Returns the configured values to their default values.

This chapter describes how to configure the Preventive Maintenance function and its operation on the Touch.

1 Overview

1.1 How the Preventive Maintenance Function is Used

The Preventive Maintenance function monitors the state of devices and counts the time the value of the monitored devices are 1, as well as the number of times the values of monitored devices change to 1.

The Preventive Maintenance function can perform the following functions.

- Monitor devices that turn on lighting or warning lights and count the operation time

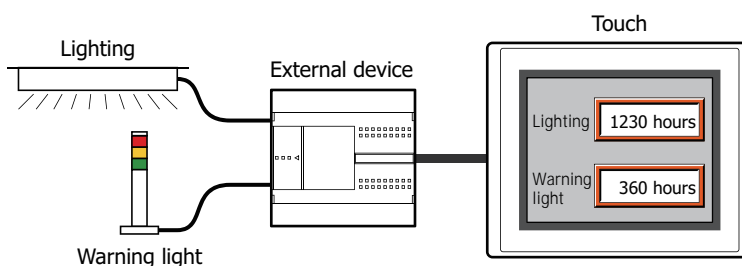

- Report the replacement time for lighting and warning lights by the counted operation time

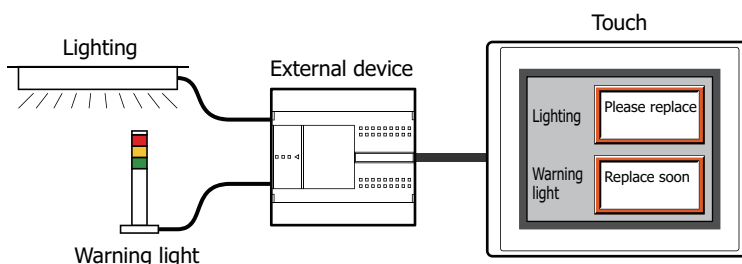

- Monitor devices connected to buttons and relays and count the operation count

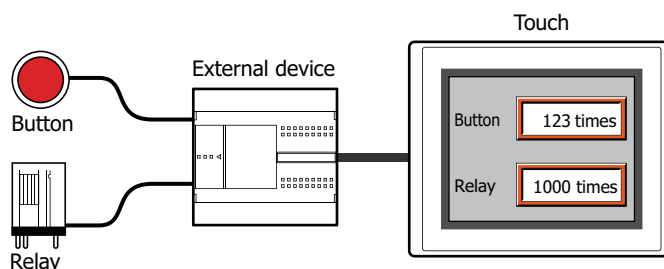

- Report the inspection time for buttons and relays by the counted operation count

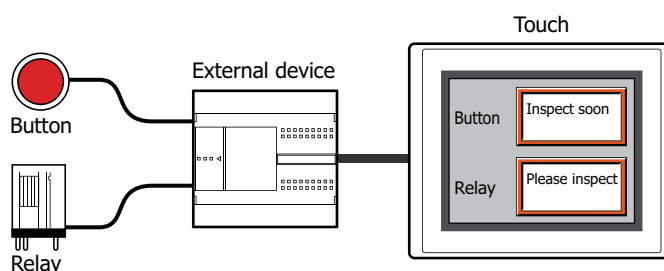

1.2 Counting the Operation Time and Operation Count

The operation time and operation count are counted up to the set maximum value. The counted operation time and operation count are saved in HMI Keep Registers (LKR) and the values are retained until they are reset. To reset a counted value, set the value of the configured HMI Keep Register (LKR) to 0.

The maximum value that can be configured varies based on the data type of the destination device for the operation time and operation count.

● Counting the Operation Time

While the value of Monitor Device is 1, 1 is added to the value of device (Operation Time Device) configured in **Measure Operation Time** for each second that elapses. The operation time is not counted when it is less than one second.

The counted operation time is written to the device configured in **Measure Operation Time**.

Example: When the value of Monitor Device M0 is 1, 1 is added to the value of Operation Time Device LKR0.

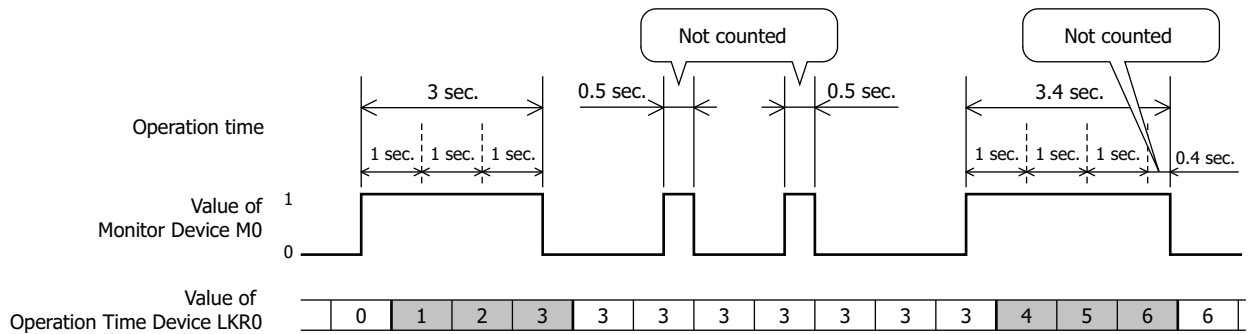

● Counting the Operation Count

When the value of Monitor Device changes from 0 to 1, 1 is added to the value of device (Operation Count Device) configured in **Measure Operation Count**.

The counted operation count is written to the device configured in **Measure Operation Count**.

Example: When the value of Monitor Device M0 changes from 0 to 1, 1 is added to the value of Operation Count Device LKR0.

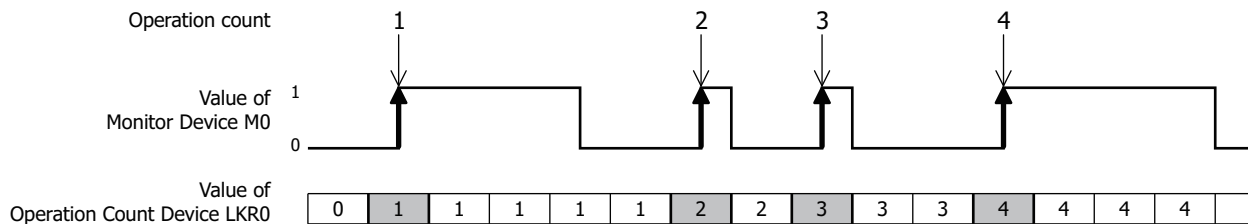

! If the value of Monitor Device changes from 0 to 1 in an interval shorter than the Touch scan time and the communication cycle with external devices, the operation time and operation count is not counted normally. You can check the maximum Touch scan time (x 1 millisecond) with the value of HMI Special Data Register LSD4. You can check the communication cycle with external devices (x 1 millisecond) with the value of HMI Special Data Register LSD6. For details, refer to Chapter 27 "HMI Special Data Register (LSD)" on page 27-9.

1.3 Thresholds

The threshold is a value that is the criterion for reporting to a configured device (Report Device) when the value counted for the operation time or operation count (the value of Operation Time Device or Operation Count Device) has reached the threshold value. 1 is written to the configured device when the operation time and operation count reach the threshold.

Example: When the value of Operation Time Device LKR0 reaches the threshold set for level 1 through level 3, 1 is written to the Report Device configured for each level, LM1 through LM3.

Level	Threshold	Report Device
Level 1	10	LM1
Level 2	15	LM2
Level 3	20	LM3

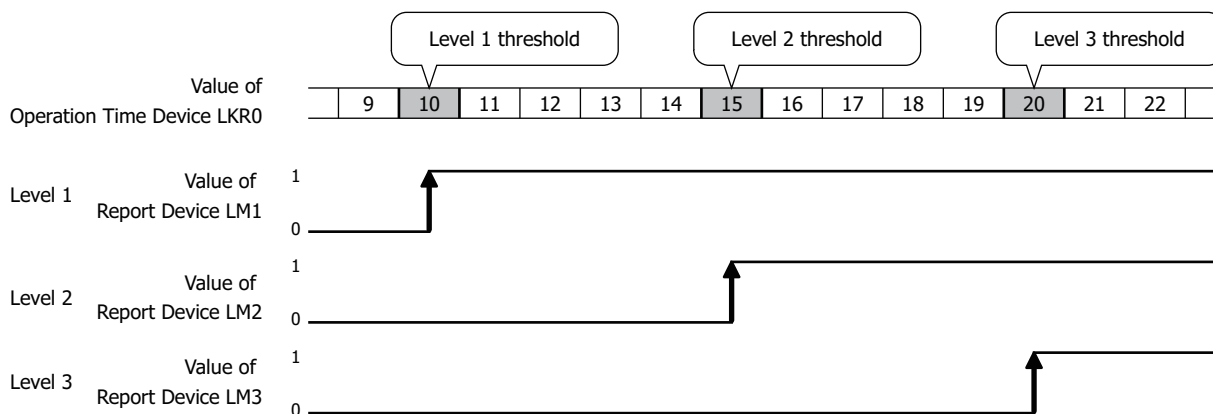

2 Preventive Maintenance Function Configuration Procedure

This section describes the configuration procedure for the Preventive Maintenance function.

2.1 Counting Operation Time and Operation Count

- 1 On the **Configuration** tab, in the **System Setup** group, click **Preventive Maintenance**. The Preventive Maintenance Settings dialog box is displayed.



- 2 Specify the number of devices to monitor in **Number of Items**.

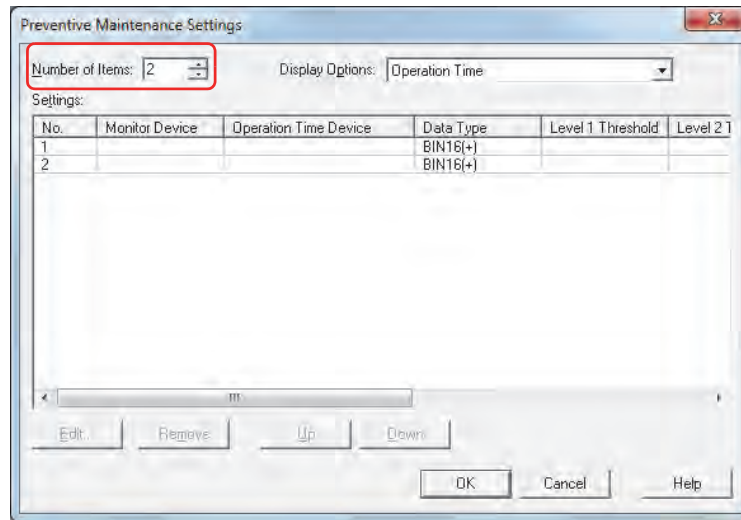

- 3 Select the item to display in **Settings** with **Display Options**. Select **Operation Time + Operation Count**. The **Operation Time** and **Operation Count** settings are displayed in **Settings**.
- 4 Select the number to register the Preventive Maintenance settings to in **Settings**, then click **Edit**. The Individual Settings dialog box is displayed.
- 5 Specify the bit device or bit of the word device to monitor with **Monitor Device**. Click **...** to display the Device Address Settings dialog box. For the device address configuration procedure, refer to Chapter 2 "5.1 Device Address Settings" on page 2-61.

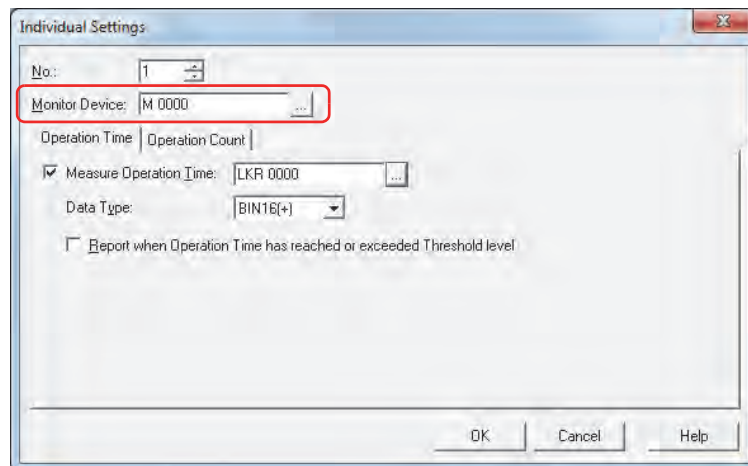

- 6 Select the **Measure Operation Time** check box on the **Operation Time** tab.
If you are not counting the operation time, leave the **Measure Operation Time** check box cleared and proceed to step 9.
- 7 Specify the destination device for the counted operation time.
You can only specify an HMI Keep Register (LKR).
Click [...] to display the Device Address Settings dialog box. For the device address configuration procedure, refer to Chapter 2 "5.1 Device Address Settings" on page 2-61.
- 8 Select the data type for the value of the **Measure Operation Time** device from **Data Type**.
This concludes configuring operation time counting.
- 9 Click the **Operation Count** tab.

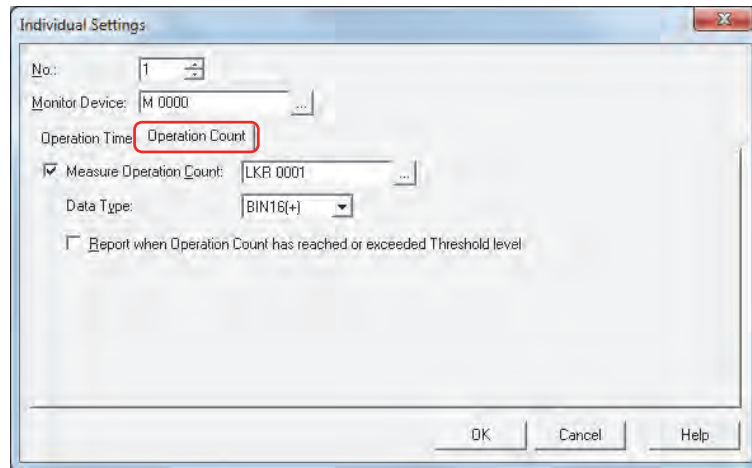

- 10 Select the **Measure Operation Count** check box.
If you are not counting the operation count, leave the **Measure Operation Count** check box cleared and proceed to step 13.
- 11 Specify the destination device for the counted operation count.
You can only specify an HMI Keep Register (LKR).
Click [...] to display the Device Address Settings dialog box. For the device address configuration procedure, refer to Chapter 2 "5.1 Device Address Settings" on page 2-61.
- 12 Select the data type for the value of the **Measure Operation Count** device from **Data Type**.
This concludes configuring operation count counting.
- 13 Click **OK** to close the Individual Settings dialog box.
- 14 Repeat steps 2 through 13 to register settings to count the operation time and operation count in all the used numbers.
This concludes configuring operation time and operation count counting.

Next, configure the functions to execute using counted data.

☞ "4.1 Displaying the Counted Operation Count on a Numerical Display" on page 17-11

☞ "4.2 Notifying with a Beep when the Counted Operation Time Reaches the Threshold" on page 17-14

3 Preventive Maintenance Settings Dialog Box

This section describes the items and buttons on the Preventive Maintenance Settings dialog box and the Individual Settings dialog box.

3.1 Preventive Maintenance Settings Dialog Box

The Preventive Maintenance Settings dialog box is used to manage the preventive maintenance settings for each monitored device.

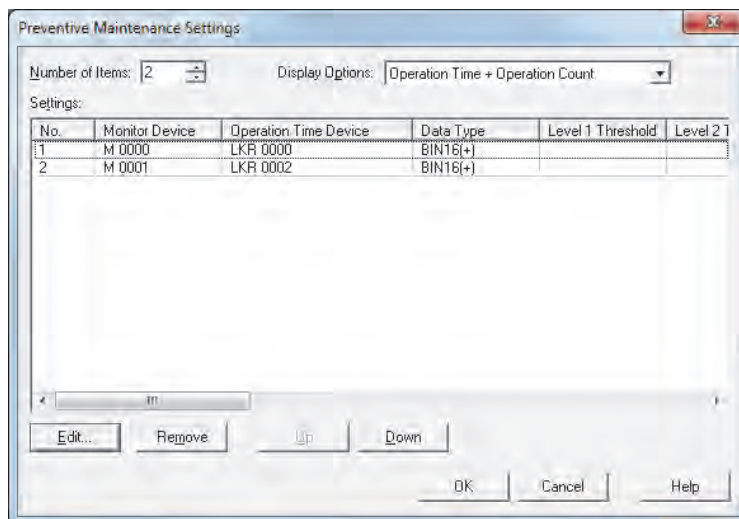

■ Number of Items

Specifies the number of devices (1 to 256) to monitor. The numbers for the amount of configured devices is displayed in **Settings**.

■ Display Options

Select the item to display in **Settings** from the following:

- Operation Time: Operation time settings are displayed in **Settings**.
- Operation Count: Operation count settings are displayed in **Settings**.
- Operation Time + Operation Count: Operation time and operation count settings are displayed in **Settings**.

■ Settings

Edits the settings for each number.

- No.:

 - Shows the number of the preventive maintenance settings to manage. Double clicking the cell displays the Individual Settings dialog box. For details, refer to “3.2 Individual Settings Dialog Box” on page 17-8.

- Monitor Device:

 - Shows the bit device or bit of the word device to count the operation time or operation count. Double clicking the cell displays the Device Address Settings dialog box. For the device address configuration procedure, refer to Chapter 2 “5.1 Device Address Settings” on page 2-61.

- Operation Time Device:

 - Shows the destination device for the counted operation time. You can only specify an HMI Keep Register (LKR). Double clicking the cell displays the Device Address Settings dialog box. For the device address configuration procedure, refer to Chapter 2 “5.1 Device Address Settings” on page 2-61. This option is only displayed when **Operation Time** or **Operation Time + Operation Count** is selected in **Display Options**.

- Data Type:

 - Shows the date type of the operation time device. Double clicking the cell displays the Individual Settings dialog box. For details, refer to “3.2 Individual Settings Dialog Box” on page 17-8. This option is only displayed when **Operation Time** or **Operation Time + Operation Count** is selected in **Display Options**.

- Level 1 to 3 Threshold:** Shows the time as a constant or a device that is the criterion for reporting at level 1 through level 3. For a constant, double clicking the cell displays the Individual Settings dialog box. For details, refer to "3.2 Individual Settings Dialog Box" on page 17-8. For a device, the Device Address Settings dialog box is displayed. For the device address configuration procedure, refer to Chapter 2 "5.1 Device Address Settings" on page 2-61. This option is only displayed when **Operation Time** or **Operation Time + Operation Count** is selected in **Display Options**.
- Level 1 to 3 Report Device:** Shows the bit device or bit of the word device for reporting when the operation time reaches or exceeds the level 1 through level 3 thresholds. Double clicking the cell displays the Device Address Settings dialog box. For the device address configuration procedure, refer to Chapter 2 "5.1 Device Address Settings" on page 2-61. This option is only displayed when **Operation Time** or **Operation Time + Operation Count** is selected in **Display Options**.
- Operation Count Device:** Shows the destination device for the counted operation count. You can only specify an HMI Keep Register (LKR). Double clicking the cell displays the Device Address Settings dialog box. For the device address configuration procedure, refer to Chapter 2 "5.1 Device Address Settings" on page 2-61. This option is only displayed when **Operation Count** or **Operation Time + Operation Count** is selected in **Display Options**.
- Data Type:** Shows the date type of the operation count device. Double clicking the cell displays the Individual Settings dialog box. For details, refer to "3.2 Individual Settings Dialog Box" on page 17-8. This option is only displayed when **Operation Count** or **Operation Time + Operation Count** is selected in **Display Options**.
- Level 1 to 3 Threshold:** Shows the count as a constant or a device that is the criterion for reporting at level 1 through level 3. For a constant, double clicking the cell displays the Individual Settings dialog box. For details, refer to "3.2 Individual Settings Dialog Box" on page 17-8. For a device, the Device Address Settings dialog box is displayed. For the device address configuration procedure, refer to Chapter 2 "5.1 Device Address Settings" on page 2-61. This option is only displayed when **Operation Count** or **Operation Time + Operation Count** is selected in **Display Options**.
- Level 1 to 3 Report Device:** Shows the bit device or bit of the word device for reporting when the operation count reaches or exceeds the level 1 through level 3 thresholds. Double clicking the cell displays the Device Address Settings dialog box. For the device address configuration procedure, refer to Chapter 2 "5.1 Device Address Settings" on page 2-61. This option is only displayed when **Operation Count** or **Operation Time + Operation Count** is selected in **Display Options**.
- **Edit**
Registers or changes the settings for the selected number.
Select a number, and then click this button to display the Individual Settings dialog box. The configured content for the selected number is reflected in the Individual Settings dialog box. For details, refer to "3.2 Individual Settings Dialog Box" on page 17-8.
 - **Remove**
Deletes the settings for the selected number.
Select a number, and then click this button.
 - **Up**
Shifts the selected settings upward in the list.
 - **Down**
Shifts the selected settings downward in the list.

3.2 Individual Settings Dialog Box

The Individual Settings dialog box is used to configure the operation time and operation count settings for each monitored device.

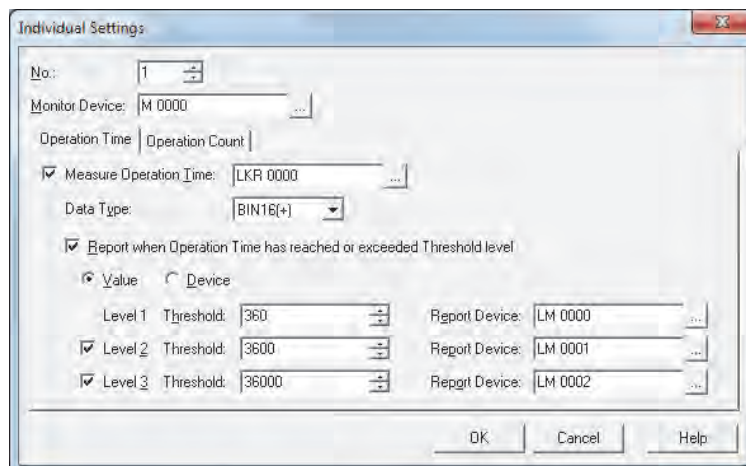

- No.:** Shows the number selected in Settings in the Preventive Maintenance Settings dialog box. To change the set number, specify a number (1 to 256). You can only specify a number of the amount of devices configured by **Number of Items** in the Preventive Maintenance Settings dialog box.
- Monitor Device:** Specifies the bit device or bit of the word device to count the operation time or operation count. Click to display the Device Address Settings dialog box. For the device address configuration procedure, refer to Chapter 2 "5.1 Device Address Settings" on page 2-61.

● Operation Time Tab

The **Operation Time** tab is used to configure the destination device for the counted operation time and the report conditions when the threshold is reached or exceeded.

■ Measure Operation Time

Select this check box to count the operation time.

(Operation Time Device): Specifies the destination device for the counted operation time. You can only specify an HMI Keep Register (LKR).

Click to display the Device Address Settings dialog box. For the device address configuration procedure, refer to Chapter 2 "5.1 Device Address Settings" on page 2-61.



If you specify the same device as the operation time device for multiple numbers, the counted operation time is added in total by all the monitored devices for each number and the function will not be able to count normally.

■ Data Type

Select the data type for the operation time device as **BIN16 (+)** or **BIN32 (+)**. For details, refer to Chapter 2 "1.1 Available Data" on page 2-1.

■ Report when Operation Time has reached or exceeded Threshold level

Select this check box to report when the counted operation time reaches or exceeds the threshold.

■ (Data Type)

Selects the type of data for the threshold.

Value: Uses a constant as the threshold.

Device: Uses a value of device as the threshold.

■ Level 1

Configures the level 1 threshold and report device.

Threshold Specifies the time as a constant or a device that is the criterion for reporting at level 1. For a constant, the range that can be set varies based on the data type. For a device, click to display the Device Address Settings dialog box. For the device address configuration procedure, refer to Chapter 2 "5.1 Device Address Settings" on page 2-61.

Report Device: Specifies the bit device or bit of the word device for reporting when the operation time reaches or exceeds the level 1 threshold.

Click to display the Device Address Settings dialog box. For the device address configuration procedure, refer to Chapter 2 "5.1 Device Address Settings" on page 2-61.

■ Level 2

Select this check box to configure the level 2 threshold and report device.

Threshold Specifies the time as a constant or a device that is the criterion for reporting at level 2. For a constant, the range that can be set varies based on the data type. For a device, click to display the Device Address Settings dialog box. For the device address configuration procedure, refer to Chapter 2 "5.1 Device Address Settings" on page 2-61.

Report Device: Specifies the bit device or bit of the word device for reporting when the operation time reaches or exceeds the level 2 threshold.

Click to display the Device Address Settings dialog box. For the device address configuration procedure, refer to Chapter 2 "5.1 Device Address Settings" on page 2-61.

■ Level 3

Select this check box to configure the level 3 threshold and report device.

Threshold Specifies the time as a constant or a device that is the criterion for reporting at level 3. For a constant, the range that can be set varies based on the data type. For a device, click to display the Device Address Settings dialog box. For the device address configuration procedure, refer to Chapter 2 "5.1 Device Address Settings" on page 2-61.

Report Device: Specifies the bit device or bit of the word device for reporting when the operation time reaches or exceeds the level 3 threshold.

Click to display the Device Address Settings dialog box. For the device address configuration procedure, refer to Chapter 2 "5.1 Device Address Settings" on page 2-61.

● Operation Count Tab

The **Operation Count** tab is used to configure the destination device for the counted operation count and the report conditions when the threshold is reached or exceeded.

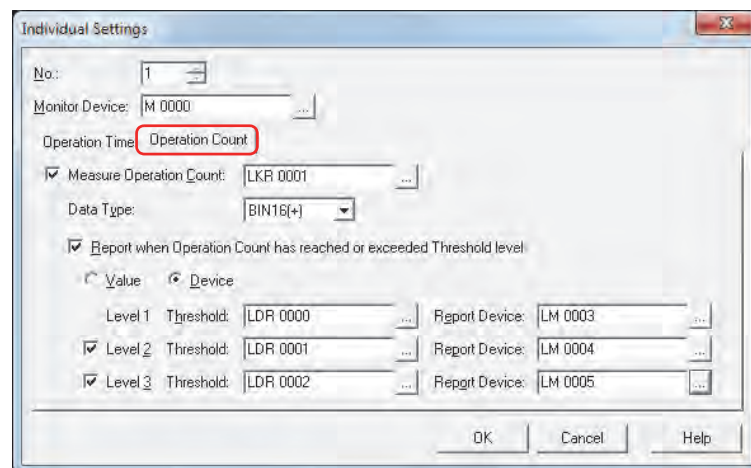

■ Measure Operation Count

Select this check box to count the operation count.

(Operation Count Device): Specifies the destination device for the counted operation count. You can only specify an HMI Keep Register (LKR).

Click to display the Device Address Settings dialog box. For the device address configuration procedure, refer to Chapter 2 "5.1 Device Address Settings" on page 2-61.



If you specify the same device as the operation count device for multiple numbers, the counted operation count is added in total by all the monitored devices for each number and the function will not be able to count normally.

■ Data Type

Select the data type for the operation count device as **BIN16 (+)** or **BIN32 (+)**. For details, refer to Chapter 2 “1.1 Available Data” on page 2-1.

■ Report when Operation Count has reached or exceeded Threshold level

Select this check box to report when the counted operation count reaches or exceeds the threshold.

■ (Data Type)

Selects the type of data for the threshold.

Value: Uses a constant as the threshold.

Device: Uses a value of device as the threshold.

■ Level 1

Configures the level 1 threshold and report device.

Threshold Specifies the count as a constant or a device that is the criterion for reporting at level 1. For a constant, the range that can be set varies based on the data type. For a device, click  to display the Device Address Settings dialog box. For the device address configuration procedure, refer to Chapter 2 “5.1 Device Address Settings” on page 2-61.

Report Device: Specifies the bit device or bit of the word device for reporting when the operation count reaches or exceeds the level 1 threshold.

Click  to display the Device Address Settings dialog box. For the device address configuration procedure, refer to Chapter 2 “5.1 Device Address Settings” on page 2-61.

■ Level 2

Select this check box to configure the level 2 threshold and report device.

Threshold Specifies the count as a constant or a device that is the criterion for reporting at level 2. For a constant, the range that can be set varies based on the data type. For a device, click  to display the Device Address Settings dialog box. For the device address configuration procedure, refer to Chapter 2 “5.1 Device Address Settings” on page 2-61.

Report Device: Specifies the bit device or bit of the word device for reporting when the operation count reaches or exceeds the level 2 threshold.

Click  to display the Device Address Settings dialog box. For the device address configuration procedure, refer to Chapter 2 “5.1 Device Address Settings” on page 2-61.

■ Level 3

Select this check box to configure the level 3 threshold and report device.

Threshold Specifies the count as a constant or a device that is the criterion for reporting at level 3. For a constant, the range that can be set varies based on the data type. For a device, click  to display the Device Address Settings dialog box. For the device address configuration procedure, refer to Chapter 2 “5.1 Device Address Settings” on page 2-61.

Report Device: Specifies the bit device or bit of the word device for reporting when the operation count reaches or exceeds the level 3 threshold.

Click  to display the Device Address Settings dialog box. For the device address configuration procedure, refer to Chapter 2 “5.1 Device Address Settings” on page 2-61.

4 Using the Data

4.1 Displaying the Counted Operation Count on a Numerical Display

- 1 On the **Configuration** tab, in the **System Setup** group, click **Preventive Maintenance**.
The Preventive Maintenance Settings dialog box is displayed.

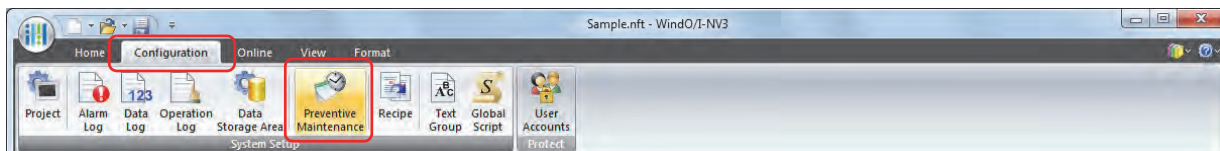

- 2 Specify the number of devices to monitor in **Number of Items**.

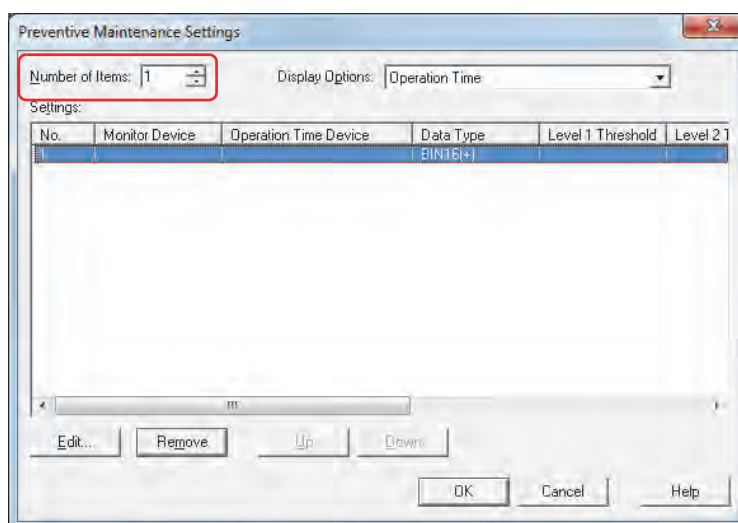

- 3 Select the item to display in **Settings** with **Display Options**.
Select **Operation Count**.
Operation count settings are displayed in **Settings**.
- 4 Select the number to register the Preventive Maintenance settings to in **Settings**, then click **Edit**.
The Individual Settings dialog box is displayed.
- 5 Specify the bit device or bit of the word device to monitor with **Monitor Device**.

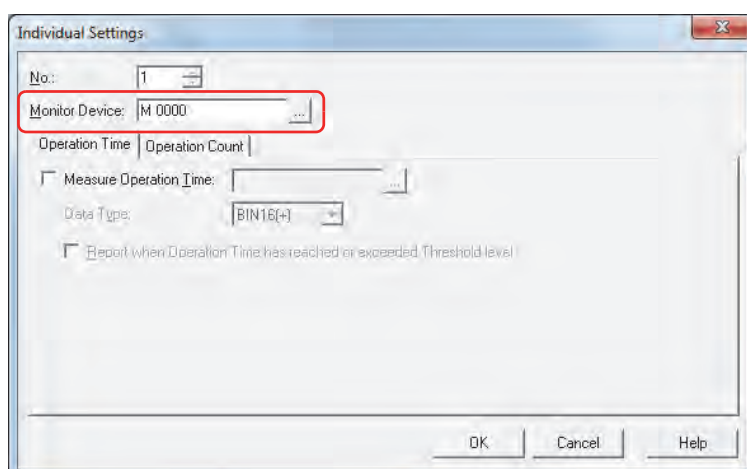

- 6 Click the **Operation Count** tab.

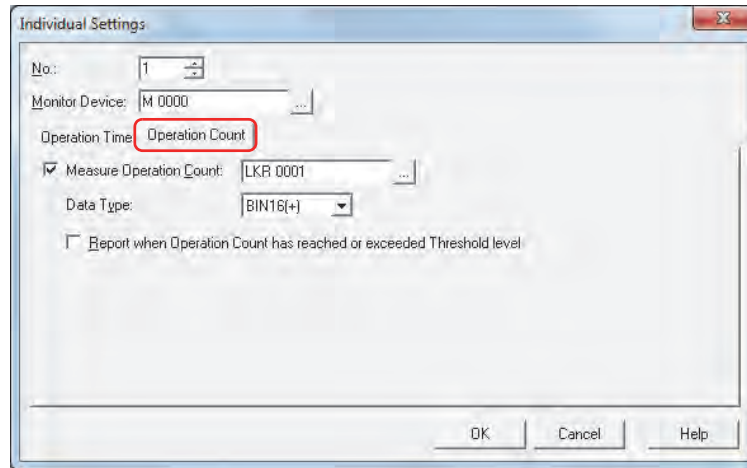

- 7 Select the **Measure Operation Count** check box and specify the destination device for the counted operation count.
- 8 Select the data type for the value of the **Measure Operation Count** device from **Data Type**.
- 9 On the **Home** tab, in the **Parts** group, click **Data Displays**, and then click **Numerical Display**.

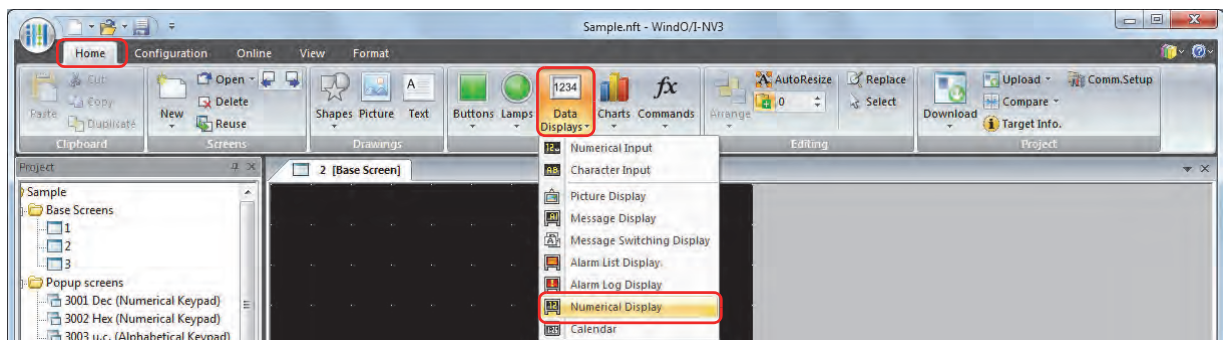

- 10 Click a point on the edit screen where you want to place the Numerical Display.
- 11 Double-click the dropped Numerical Display and the Properties dialog box is displayed.

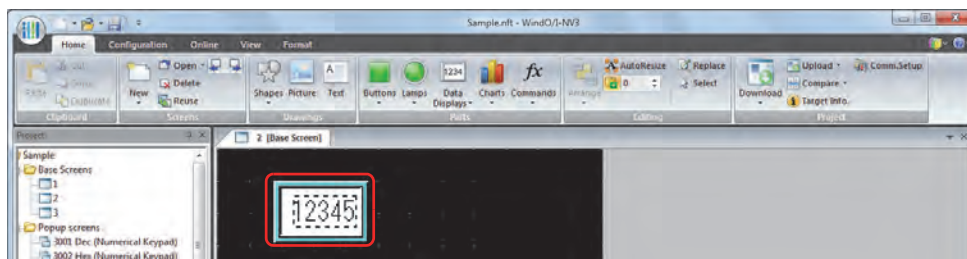

- 12 On the **General** tab, under **Display Type**, click **Decimal**.

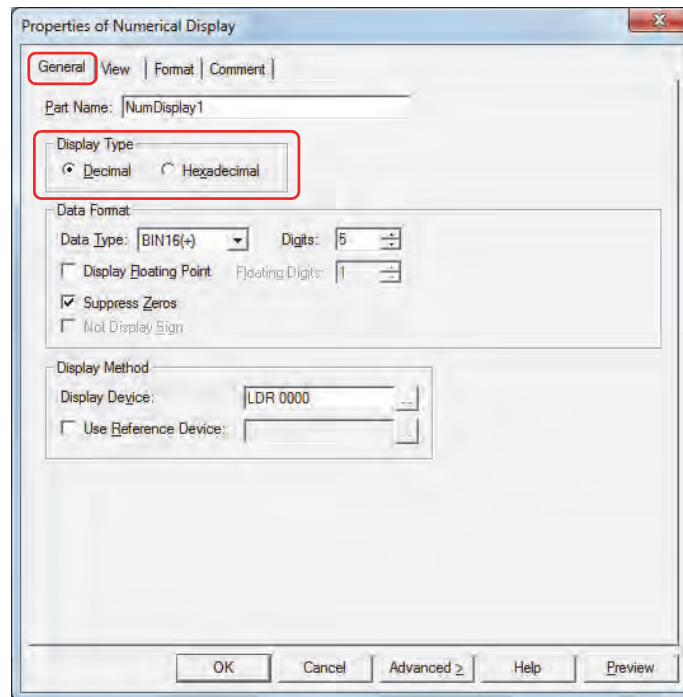

- 13 Under **Data Format**, in **Data Type**, select the data type for the value to display.
Select the same data type as the data type selected on the **Operation Count** tab in the Preventive Maintenance settings Individual Settings dialog box.
- 14 Specify **Digits** for the value to display.
The digits that can be set varies based on the display type or data type.
- 15 Under **Display Method**, in **Display Device**, specify the destination device for the counted operation count.
Select the same device as the device configured with **Measure Operation Count** on the **Operation Count** tab in the Preventive Maintenance settings Individual Settings dialog box.
- 16 Click **OK**.
The properties dialog box closes.
This concludes the configuration to display the counted operation count on a Numerical Display.

4.2 Notifying with a Beep when the Counted Operation Time Reaches the Threshold

- 1 On the **Configuration** tab, in the **System Setup** group, click **Preventive Maintenance**.
The Preventive Maintenance Settings dialog box is displayed.

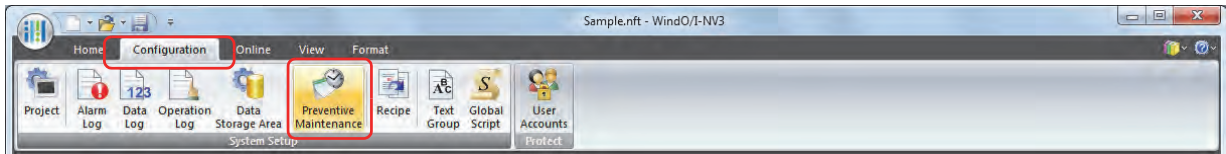

- 2 Specify the number of devices to monitor in **Number of Items**.

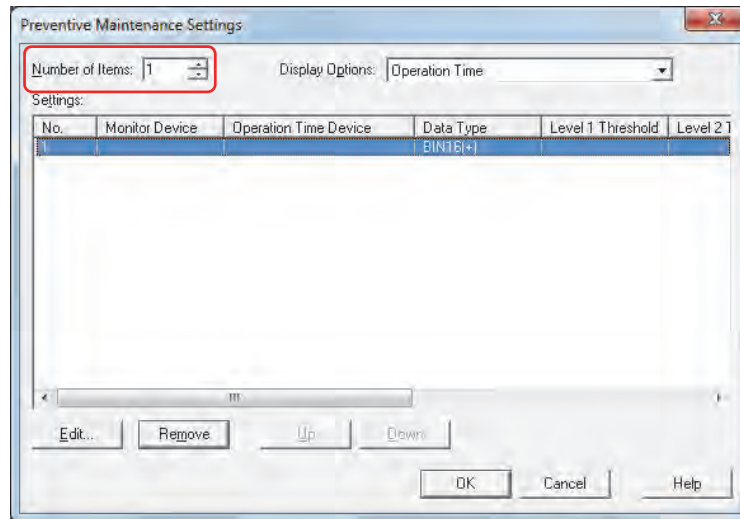

- 3 Select the number to register the Preventive Maintenance settings to in **Settings**, then click **Edit**.
The Individual Settings dialog box is displayed.
- 4 Specify the bit device or bit of the word device to monitor with **Monitor Device**.

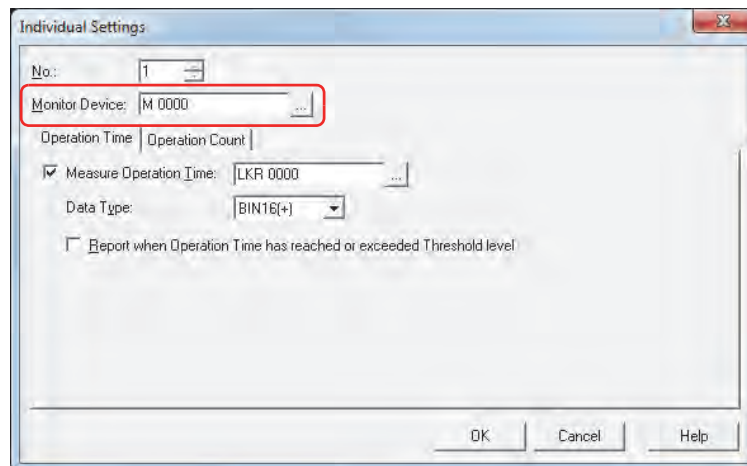

- 5 Select the **Measure Operation Time** check box on the **Operation Time** tab and specify the destination device for the counted operation time.
- 6 Select the data type for the value of the **Measure Operation Time** device from **Data Type**.

- 7 Select the **Report when Operation Time has reached or exceeded Threshold level** check box.

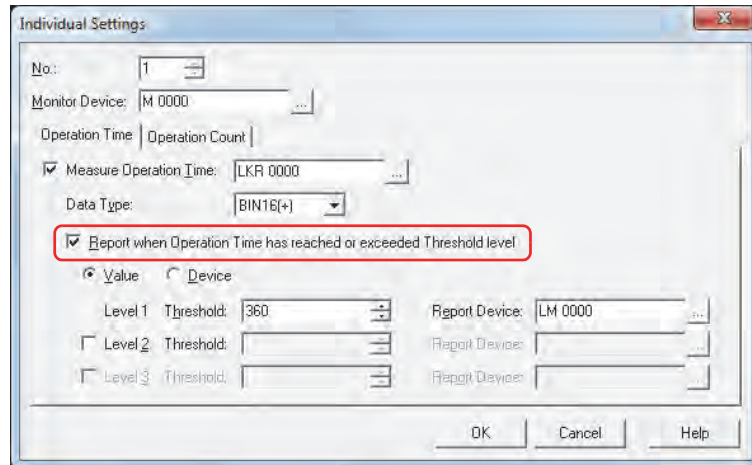

- 8 Select the type of data for the threshold.

If you select **Value**, specify the threshold as a constant.

If you select **Device**, specify the threshold as a value of device.

- 9 Configure **Threshold** for level 1.

When you select **Value** as the threshold data type, specify the threshold as a constant. The range for the constant that can be set varies based on the data type.

When you select **Device** as the threshold data type, specify the threshold as a value of device. Click to display the Device Address Settings dialog box. For the device address configuration procedure, refer to Chapter 2 "5.1 Device Address Settings" on page 2-61.

- 10 Configure **Report Device** for level 1.

Specify the bit device or bit of the word device for reporting when the threshold is reached or exceeded. Click to display the Device Address Settings dialog box. For the device address configuration procedure, refer to Chapter 2 "5.1 Device Address Settings" on page 2-61.

You can only specify an internal device.

- 11 Click **OK** to close the Individual Settings dialog box.

- 12 Click **OK** to close the Preventive Maintenance Settings dialog box.

- 13 On the **Configuration** tab, in the **System Setup** group, click **Alarm Log**.

The Alarm Log Settings dialog box is displayed.

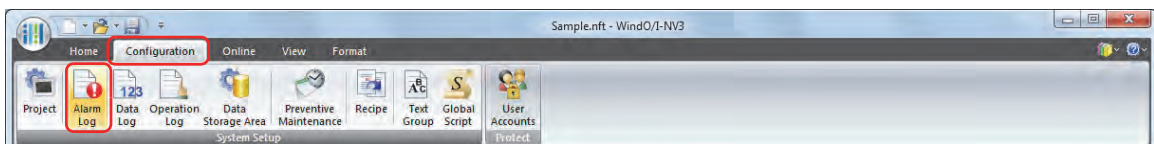

- 14 On the **Channel** tab, under **Source Device Type**, select **Bit** and specify **Number of Blocks**.

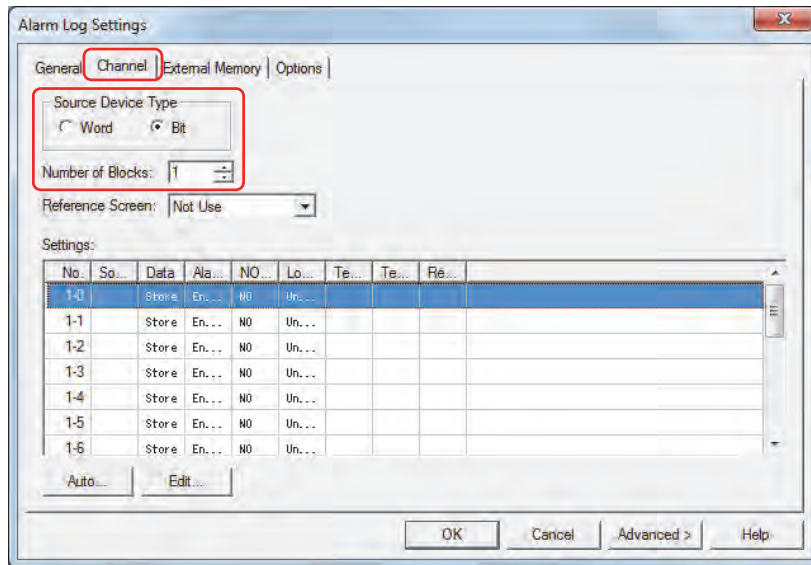

- 15 Select the channel number to register the Level 1 Report Device to, and then click **Edit**.
The Individual Settings dialog box is displayed.

- 16 Specify the Level 1 Report Device in **Source** and select **No Store** under **Data**.
Set **Source** to the Level 1 Report Device configured on the **Operation Time** tab in the Preventive Maintenance settings Individual Settings dialog box.

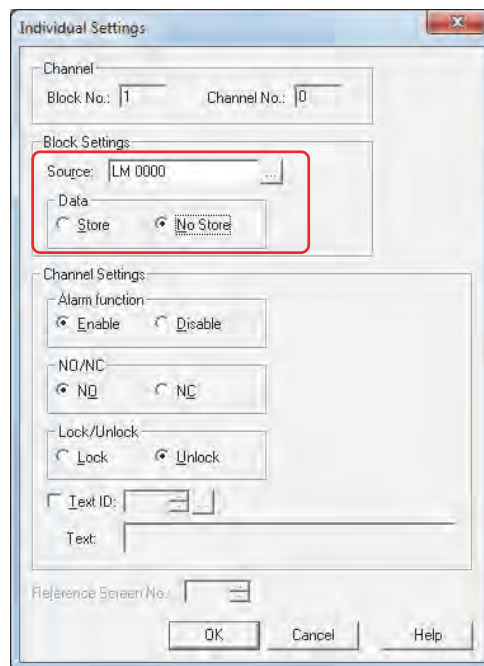

- 17 Select **Enable** under **Alarm function**, select **NO** under **NO/NC**, and then click **OK**.

- 18 Switch the alarm function for all the unused channel numbers to **Disable** in the Alarm Log Settings dialog box. Select all the unused channels, and then click **Edit**. To select multiple channels, press and hold SHIFT or CTRL while you click the specific them.

The Individual Settings dialog box is displayed.

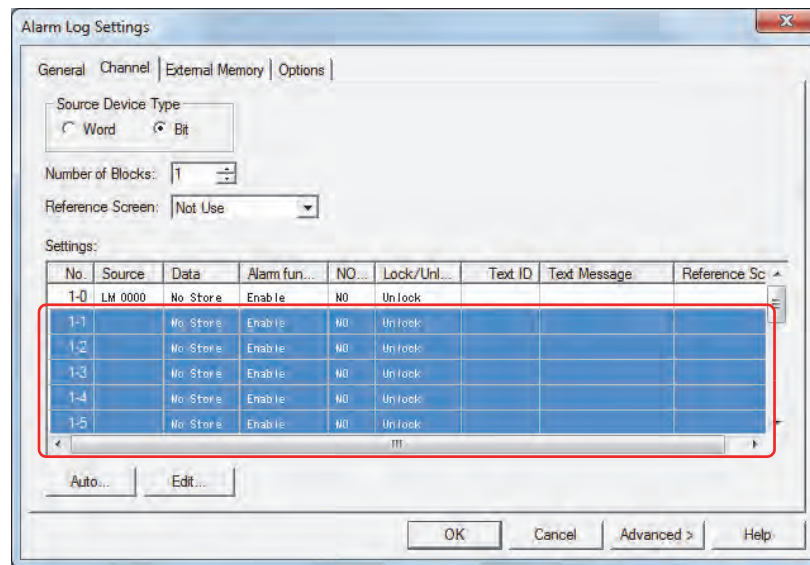

Under **Channel Settings**, in **Alarm function**, select **Disable** and then click **OK**.

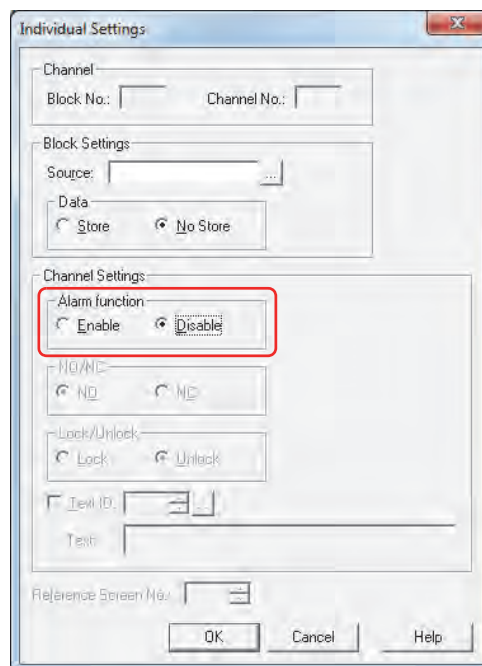

- 19 Click the **Options** tab in the Alarm Log Settings dialog box.

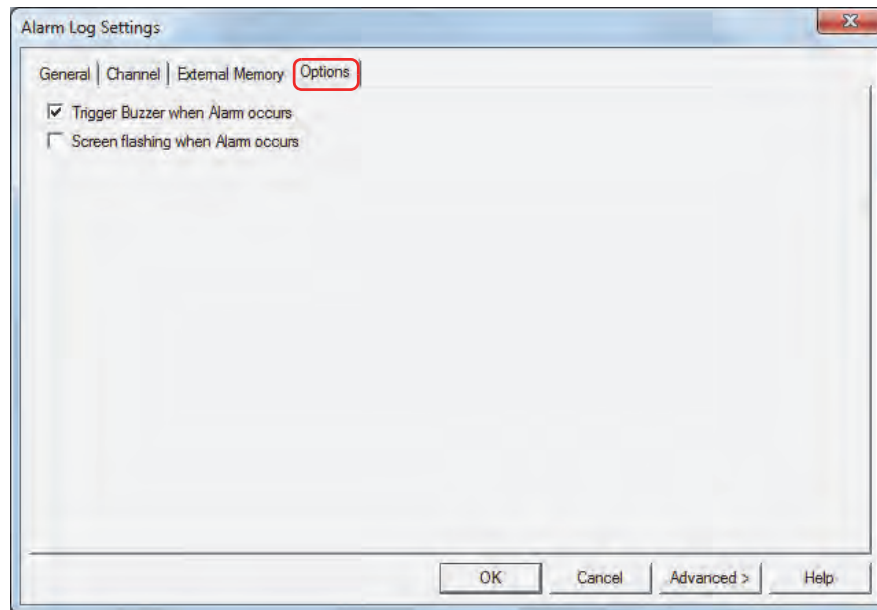

- 20 Select the **Trigger Buzzer when Alarm occurs** check box.

- 21 Click **OK**.

The Alarm Log Settings dialog box closes.

This concludes the configuration to notify with a beep when the counted operation time reaches the threshold.

Chapter 18 Recipe Function

This chapter describes how to configure the Recipe function and its operation on the Touch.

1 Overview

1.1 How the Recipe Function is Used

The Recipe function batch writes values prepared in advanced to specified devices and batch reads the values for specified devices according to the state of a device. Use this function for situations such as configuring the initial values of an external device when the Touch starts running. The data used by the Recipe function is called recipe data for the data saved in internal memory, a recipe file for data saved to the external memory, and recipe values for the values written to devices that were saved in recipe data and recipe files.

The Recipe function can perform the following functions.

- Batch write the recipe values saved in internal memory to devices when a value of device changes from 0 to 1

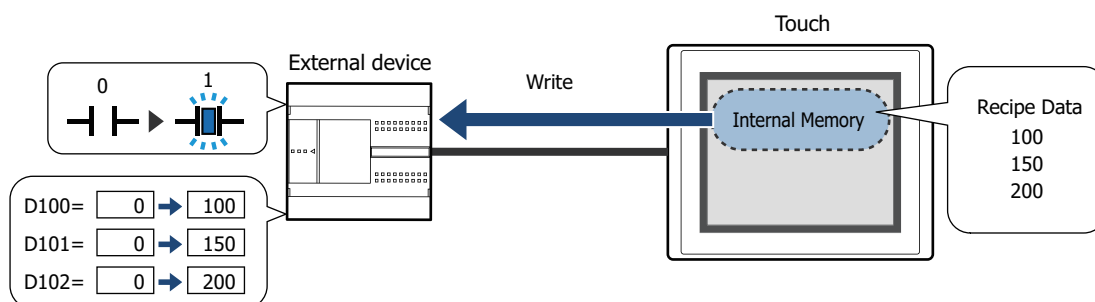

- Batch write the recipe values saved on the external memory to devices when a value of device changes from 0 to 1

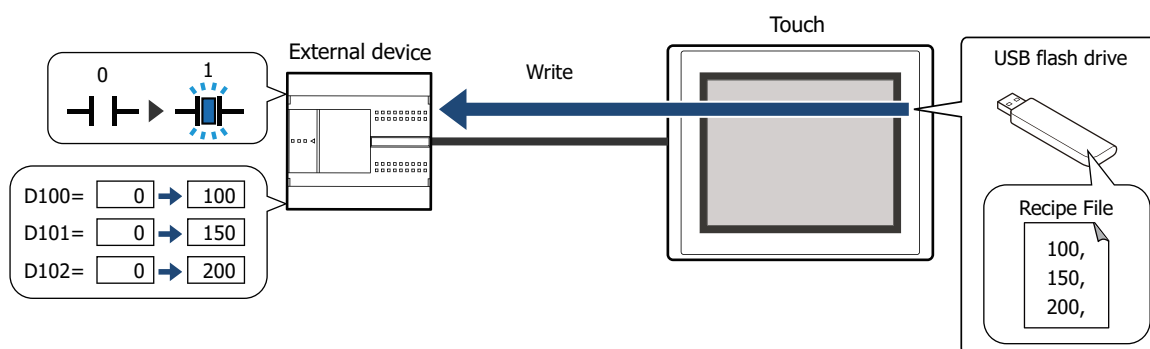

- Batch read value of a device and save them to the external memory as a recipe file when a value of device changes from 0 to 1

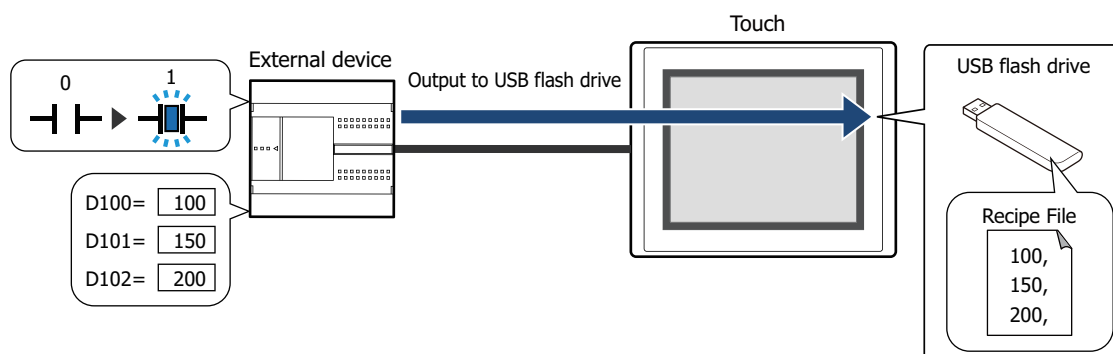

To keep the values of devices, you can use recipe function. The recipe function saves them as a recipe file in the external memory. For example, save the values of devices before the power is turned off and write them the next time the power is turned on.

1.2 Data for Recipes

The data handled by the Recipe function is based on the starting device address for the amount of data selected.

Example: When the **Top Device** is D100 and the **Number of Data** is 10

D100 value	1111
D101 value	2222
D102 value	3333
D103 value	4444
D104 value	5555
D105 value	6666
D106 value	7777
D107 value	8888
D108 value	9999
D109 value	11111

1.3 Data Configuration

The relationship between the Recipe function settings and the data for recipes is as follows.

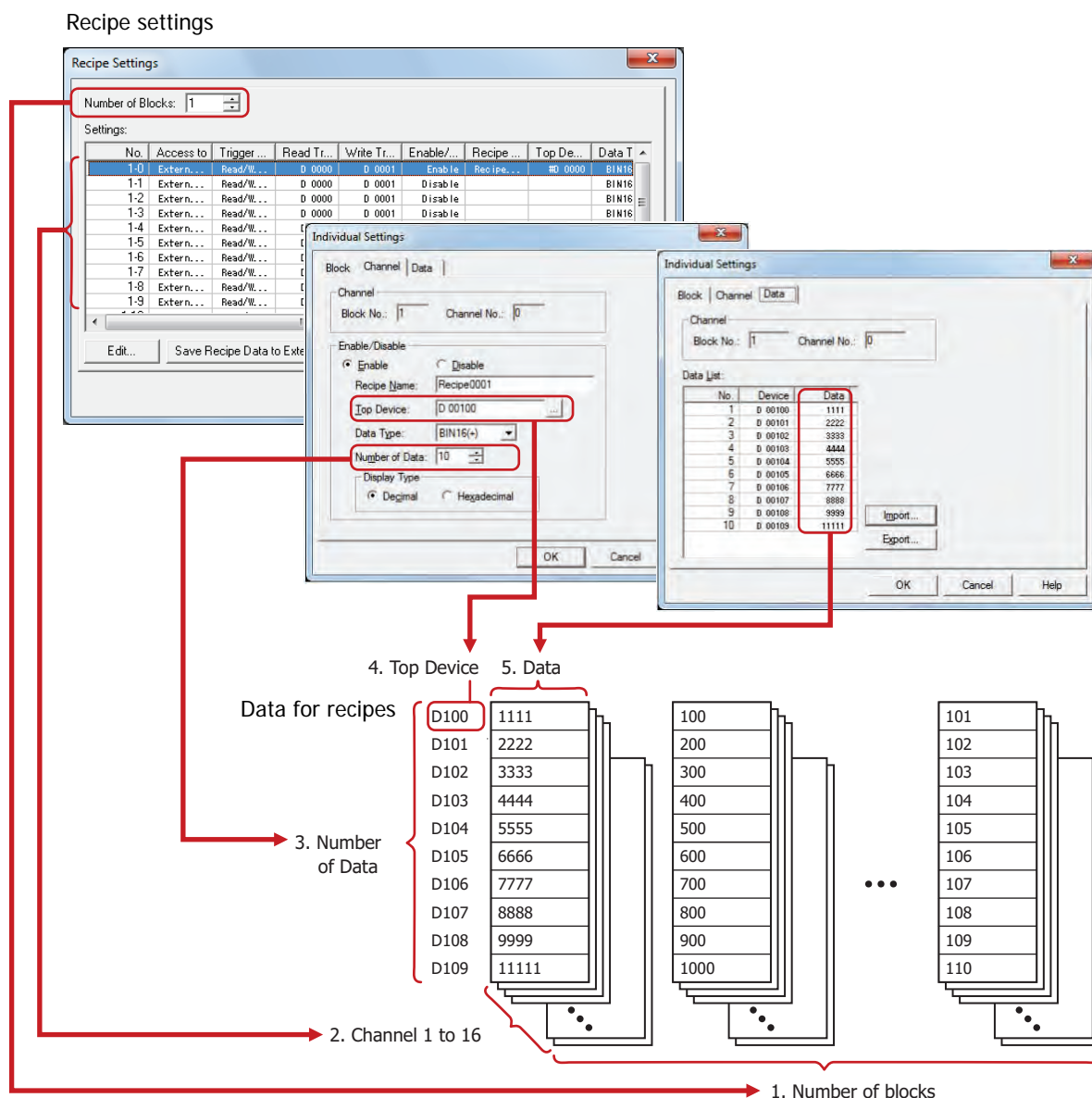

1. Number of blocks: The operation using the data for recipes is configured in blocks (0 to 64). One block is 16 channels.
2. Channels: Destination devices and recipe values are configured in channels. One channel is used for one item of data for the recipe.
3. Number of Data: The amount of data configured for one channel. The maximum number of data that can be configured is 8,192.
4. Top Device: The starting address of the destination devices for recipe values and the source devices for values of devices.
5. Data: The values to write to the devices.



If there are many word devices for the data for the recipe, it will take time to read and write them. For example, when using the Recipe function to configure initial values, if other processes are executed before the function is finished writing all the settings, you may experience unexpected results. Monitor the System Area 2 Transferring recipe bit (address+3, bit 4) while the recipe is transferring and wait until reading and writing the data for the recipe is finished before executing other processes. For details, refer to Chapter 3 "System Area" on page 3-23.

2 Recipe Function Configuration Procedure

This section describes the configuration procedure for the Recipe function.

2.1 Configuring Recipe Function Operations and Devices

- 1 On the **Configuration** tab, in the **System Setup** group, click **Recipe**.
The Recipe Settings dialog box is displayed.

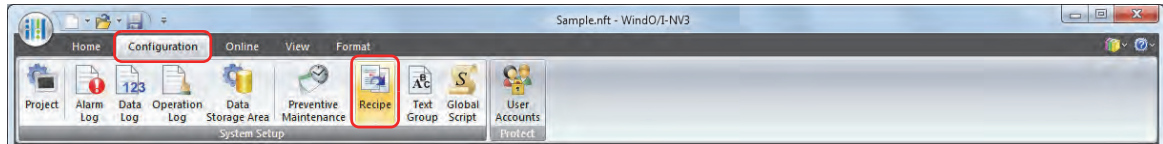

- 2 Specify the number of blocks to use as data for the recipe in **Number of Blocks**.
The operation using the data for the recipe is configured in blocks (0 to 64). One channel is used for one item of data for the recipe. One block is 16 channels.
The maximum number of blocks that can be configured is 64 blocks. The maximum number of devices that can be configured for one channel is 8,192 devices.

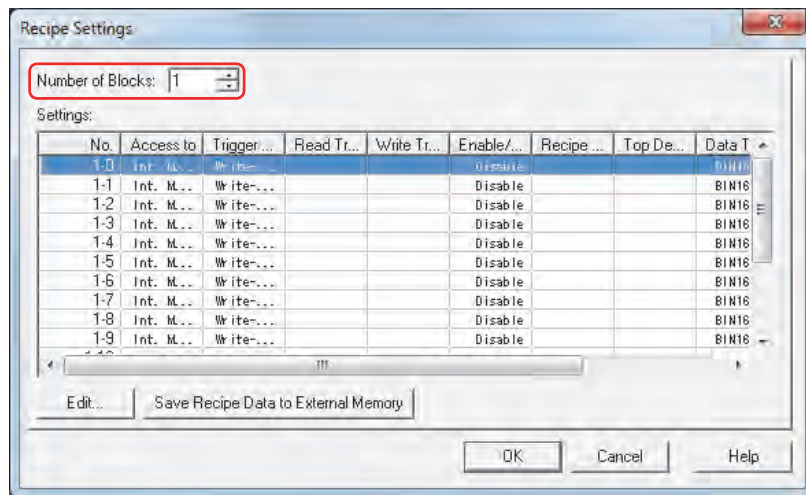

- 3 Select the number of the data for the recipe to configure in **Settings**, and then click **Edit**.
The Individual Settings dialog box is displayed.
- 4 On the **Channel** tab, under **Recipe function**, select **Enable**.
The channel for the block number displayed in **Channel** is enabled.

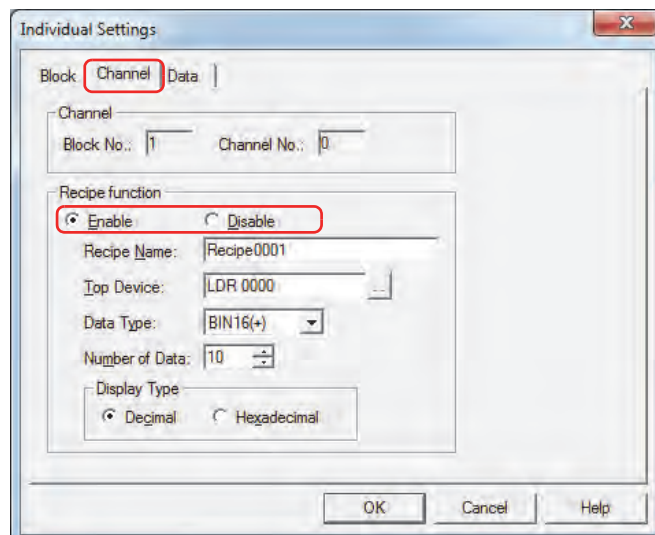

- 5 Enter the name for the Recipe function in **Recipe Name**.
The maximum number is 40 characters.
- 6 Specify the destination device for the Recipe values in **Top Device**.
To read values of devices and save them as a recipe file, specify the source device of the values.
Click to display the Device Address Settings dialog box.
For the device address configuration procedure, refer to Chapter 2 "5.1 Device Address Settings" on page 2-61.
The specified device addresses are configured sequentially from the number 1 in **Data List** on the **Data** tab.
- 7 Select the data type for the values to write with **Data Type**.
To read values of devices and save them as a recipe file, specify the type of data for the read values.
- 8 With **Number of Data**, specify the number of destination devices starting with the device address configured by **Top Device**.
To read values of devices and save them as a recipe file, specify the number of source devices.
The sequential device addresses from the starting address for the number of configured devices is displayed in **Data List** on the **Data** tab.
The amount of data that can be set varies based on the data type. When **BIN16 (+)**, **BIN16 (+/-)**, or **BCD4** is selected for **Data Type**, up to 8,192 items of data can be configured. When **BIN32 (+)**, **BIN32 (+/-)**, or **BCD8** is selected, up to 4,096 items of data can be configured.
- 9 With **Display Type**, select the display type for **Data** to configure in **Data List** on the **Data** tab.
To save data to a recipe file, the display type is decimal for all.
- 10 Click the **Data** tab.

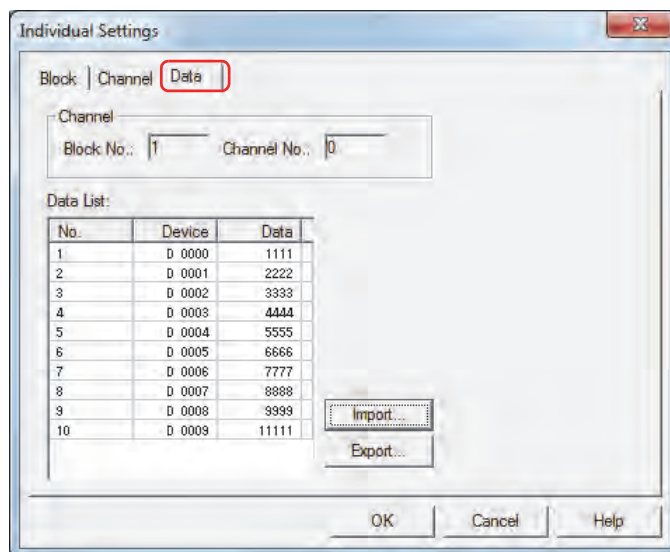

The data for the recipe in the amount specified by **Number of Data** on the **Channel** tab is configured in **Data List**. In **Device**, the devices are sequentially configured starting from the device address specified by **Top Device**.

- 11 Double click the data cell for each number in **Data List** to enter the value to write to the device.
The value of device that can be configured varies based on **Data Type** and **Display Type** configured on the **Channel** tab.
When **Read-only** is selected under **Trigger Setting** on the **Block** tab, entering values of devices is unnecessary.

- 12 Click the **Block** tab.

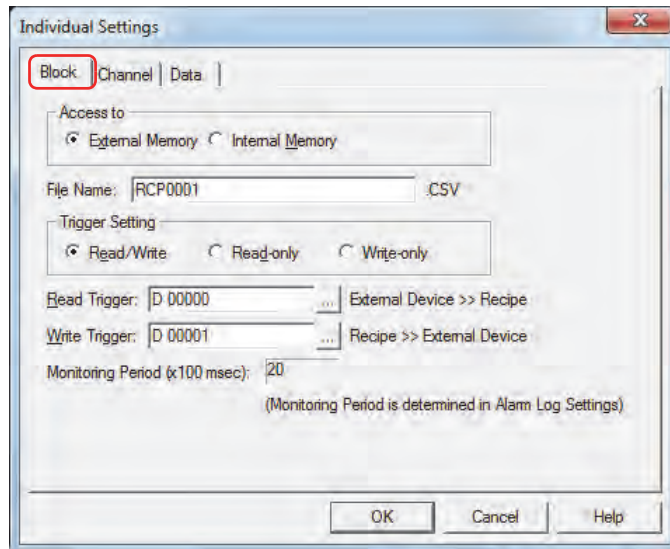

- 13 Select the destination to save recipe data to under **Access to**.
This option is set by block.

■ **External Memory**

Use a recipe file saved to the external memory.

■ **Internal Memory**

Use recipe data saved to internal memory.

If you selected **Internal Memory**, proceed to step 17.

- 14 Enter the file name for the recipe file in **File Name**.

The default is "RCPn.CSV". (n: four digit sequential number)

To change the file name, enter a new file name. The maximum number is 120 characters (including extension).

If there is a recipe file with the same file name on the external memory, the existing file is overwritten with the new file.

- 15 Select the operation using the data for the recipe under **Trigger Setting**.
This option is set by block.

■ **Read/Write**

Save batch read values of devices to the external memory as a recipe file or write them to devices as recipe values.

This option can only be configured when **External Memory** is selected under **Access to**.

■ **Read-only**

Save batch read values of devices to the external memory as a recipe file.

This option can only be configured when **External Memory** is selected under **Access to**.

■ **Write-only**

Write recipe values to devices.

If you select **Write-only**, proceed to step 17.

- 16 Specify the device that triggers batch reading values of devices and saving them to the external memory as a recipe file in **Read Trigger**.

This option is set by block.

Click to display the Device Address Settings dialog box.

For the device address configuration procedure, refer to Chapter 2 "5.1 Device Address Settings" on page 2-61.

This option can only be configured when **Read/Write** or **Read-only** is selected under **Trigger Setting**.

If you selected **Read-only**, proceed to step 18.

- 17** Specify the device that triggers batch writing recipe values to devices in **Write Trigger**.

This option is set by block.

Click  to display the Device Address Settings dialog box.

For the device address configuration procedure, refer to Chapter 2 “5.1 Device Address Settings” on page 2-61.

This option can only be configured when **Read/Write** or **Write-only** is selected under **Trigger Setting**.

- 18** Click **OK** to close the Individual Settings dialog box.

- 19** Repeat steps **3** through **18** to register data for the recipe to all the used channels.

- 20** Click **OK**.

The Recipe Settings dialog box closes.

For details on how to create and edit the data for recipes, refer to “4 Creating and Deleting Data for Recipes” on page 18-14.

3 Recipe Settings Dialog Box

This section describes the items and buttons on the Recipe Settings dialog box and the Individual Settings dialog box.

3.1 Recipe Settings Dialog Box

Use the Recipe Settings dialog box to collectively manage the save destination of data for recipes, the devices for writing recipe values and reading values of devices, and those execution conditions.

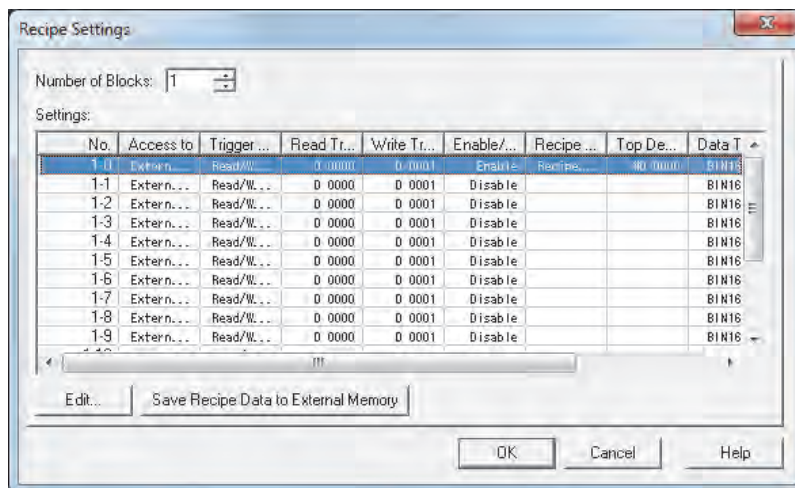

■ Number of Blocks

The operation using the data for the recipe is configured in blocks (0 to 64). One channel is used for one item of data for the recipe. One block is 16 channels.

The maximum number of blocks that can be configured is 64 blocks. The maximum number of devices that can be configured for one channel is 8,192 devices.

■ Settings

Edits the recipe settings for each channel.

- No.:
- Displayed as (Block No.)-(Channel No.). Double clicking the cell displays the Individual Settings dialog box. For details, refer to "3.2 Individual Settings Dialog Box" on page 18-10.
- Access to:
- Shows the save destination for the data for the recipe. Double clicking the cell switches between **Internal Memory** and **External Memory**.
- Trigger Setting:
- Shows the operation using the data for the recipe. When **External Memory** is selected for **Access to**, double clicking the cell switches between **Write-only**, **Read/Write**, and **Read-only**. Shows **Write-only** when **Internal Memory** is selected for **Access to**.
- Read Trigger:
- Shows the device that triggers saving the recipe file. Double clicking the cell displays the Device Address Settings dialog box. For the device address configuration procedure, refer to Chapter 2 "5.1 Device Address Settings" on page 2-61.
- This option can only be configured when **Read/Write** or **Read-only** is selected under **Trigger Setting**.
- Write Trigger:
- Shows the device that triggers writing recipe values to devices. Double clicking the cell displays the Device Address Settings dialog box. For the device address configuration procedure, refer to Chapter 2 "5.1 Device Address Settings" on page 2-61.
- This option can only be configured when **Read/Write** or **Write-only** is selected under **Trigger Setting**.
- Recipe function:
- Shows whether or not to use the Recipe function. Double clicking the cell switches between **Enable** and **Disable**.
- Recipe Name:
- Shows the name of the Recipe function for each channel. Double clicking the cell displays the Individual Settings dialog box. For details, refer to "3.2 Individual Settings Dialog Box" on page 18-10.

- Top Device:** Shows the starting address of the destination devices for recipe values and the source devices for values of devices. Double clicking the cell displays the Device Address Settings dialog box. For the device address configuration procedure, refer to Chapter 2 “5.1 Device Address Settings” on page 2-61.
This option can only be configured when **Recipe function** is **Enable**.
- Data Type:** Shows the data type of the source or destination values of devices. Double clicking the cell displays the Individual Settings dialog box. For details, refer to “3.2 Individual Settings Dialog Box” on page 18-10.
- Number of Data:** Shows the number of source or destination devices starting with the device address configured by **Top Device**. Double clicking the cell displays the Individual Settings dialog box. For details, refer to “3.2 Individual Settings Dialog Box” on page 18-10.
- Display Type:** Shows the display type of **Data** in **Data List** configured on the **Data** tab in the Individual Settings dialog box. Double clicking the cell displays the Individual Settings dialog box. For details, refer to “3.2 Individual Settings Dialog Box” on page 18-10.

■ **Edit**

Registers or changes the settings for the selected number.

Select a number in **Settings**, and then click this button to display the Individual Settings dialog box. The settings for the selected channel are reflected in the Individual Settings dialog box.

For details, refer to “3.2 Individual Settings Dialog Box” on page 18-10.

■ **Write Recipe Files to External Memory**

Saves all the settings in every channel on the Recipe Settings dialog box to the external memory as a recipe file.

Click this button to display the Select Drive dialog box.

Only saves channels configured with **Access to** set to **External Memory** and **Recipe function** set to **Enable**.

3.2 Individual Settings Dialog Box

Use the Individual Settings dialog box to register or edit the recipe settings for the selected channel.

● Block Tab

The **Block** tab is used to configure settings that are managed by blocks such as the save destination for the data for the recipe to use, the Recipe function operation, and the trigger setting.

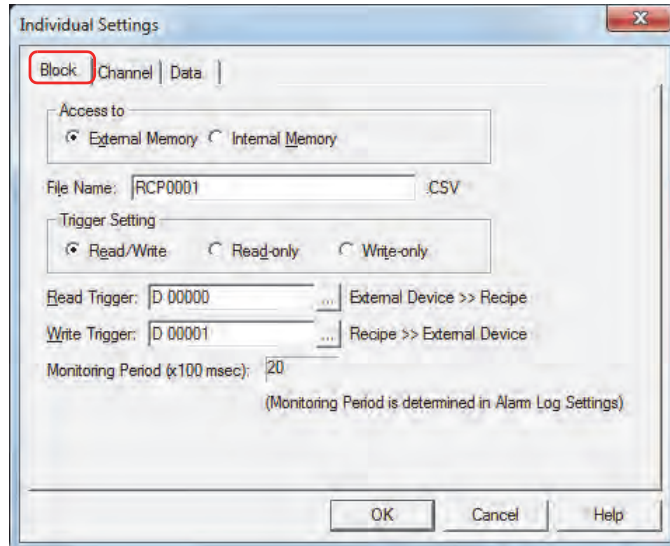

■ Access to

Selects the save destination for data for the recipe to use when writing values to devices.

External Memory: Uses a recipe file saved to the external memory.
Requires an external memory with a saved recipe file. For details, refer to “4.2 Creating Recipe Files” on page 18-17.

Internal Memory: Uses recipe data saved to internal memory.
Since recipe data is handled as a portion of project data, it may put pressure on the volume of project data that can be downloaded. One item of recipe data uses two bytes when the top device data type is 16 bits and it uses four bytes when the top device data type is 32 bits.

Example: When the top device data type is 16 bits and using one block of 16 channels of recipe data with a data amount of 10
 $2 \times 10 \times 1 \times 16 = 320$ bytes
 When the top device data type is 32 bits and using 64 blocks of 16 channels of recipe data with a data amount of 100
 $4 \times 100 \times 64 \times 16 = 409.6$ kilobytes

■ File Name

Enter the file name of the recipe file to save on the external memory.

The default is “RCP n .CSV”. (n : four digit sequential number)

To change the file name, enter a new file name. The maximum number is 120 characters (including the extension).
If there is a recipe file with the same file name on the external memory, the existing file is overwritten with the new file.

■ Trigger Setting

Selects the operation using the data for the recipe.

Read/Write: Saves values of batch read devices to the external memory as a recipe file and writes them to devices as recipe values.

This option can only be configured when **External Memory** is selected under **Access to**.

Read-only: Saves values of batch read devices to the external memory as a recipe file.

This option can only be configured when **External Memory** is selected under **Access to**.

Write-only: Writes recipe values to devices.

■ Read Trigger

Specifies the device that triggers batch reading values of devices and saving them to the external memory as a recipe file.

Click  to display the Device Address Settings dialog box. For the device address configuration procedure, refer to Chapter 2 "5.1 Device Address Settings" on page 2-61.

This option can only be configured when **Read/Write** or **Read-only** is selected under **Trigger Setting**.



Each bit of the word device configured by the read trigger corresponds to a channel.

When a bit changes from 0 to 1, a read to the device is executed.

Example: When the block 1 read trigger is specified as LDR0000

LDR0000-0 corresponds to channel 1-0, LDR0000-1 to channel 1-1, through to LDR0000-15 which corresponds to channel 1-15.

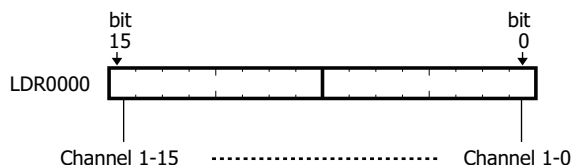

■ Write Trigger

Specifies the device that triggers batch writing recipe values to devices by block.

Click  to display the Device Address Settings dialog box. For the device address configuration procedure, refer to Chapter 2 "5.1 Device Address Settings" on page 2-61.

This option can only be configured when **Read/Write** or **Write-only** is selected under **Trigger Setting**.



Each bit of the word device configured by the write trigger and the read trigger corresponds to a channel.

When a bit changes from 0 to 1, a write to the device is executed.

Example: When the block 1 write trigger is specified as LDR0000

LDR0000-0 corresponds to channel 1-0, LDR0000-1 to channel 1-1, through to LDR0000-15 which corresponds to channel 1-15.

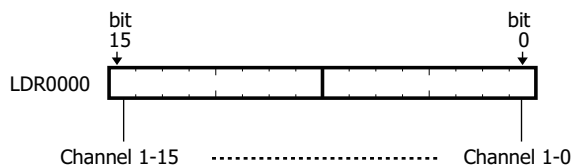

■ Monitoring Period

Shows the period to monitor the write device and the read device. This period is for detecting alarms so it is the same as the period to monitor device states. This option is configured on the **General** tab in the Alarm Log Settings dialog box.



- When recipe values are batch written to devices with **Access to** set to **External Memory** and **Trigger Setting** set to **Read/Write** or **Write-only**, if no recipe file exists in the "RECIPE" folder in the External Memory Folder on the external memory, 0 is written to all the devices.
- If a value of device reads and recipe value writes occur simultaneously, first the values of devices are read, then the recipe values are written.

● Channel Tab

The **Channel** tab is used to configure the recipe name for the selected channel and the devices to read and write values to.

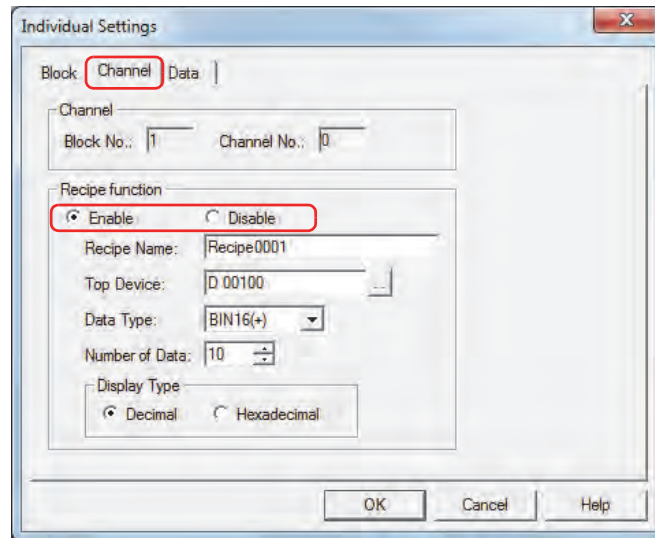

■ Channel

Shows the block number and the channel number for the selected channel.

Block No.: Shows the block number for the channel selected in **Settings**.

Channel No.: Shows the channel number for the channel selected in **Settings**.

■ Recipe function

Selects whether or not to use the Recipe function.

Enable: Writes recipe values to devices, reads values of devices and saves them to the external memory as a recipe file.

Disable: The Recipe function is not used.

■ Recipe Name

Enter the name for the Recipe function to differentiate the channel. The maximum number is 40 characters. The default is "Recipe*n*". (*n*: four digit sequential number)

■ Top Device

Specifies the starting address of the destination devices for recipe values and the source devices for values of devices.

Click to display the Device Address Settings dialog box. For the device address configuration procedure, refer to Chapter 2 "5.1 Device Address Settings" on page 2-61.

The specified device addresses are configured sequentially from the number 1 in **Data List** on the **Data** tab.

■ Data Type

Selects the type of data for recipe values to write and values of devices that are read. For details, refer to Chapter 2 "1.1 Available Data" on page 2-1.

■ Number of Data

Specifies the number of source or destination devices starting with the device address configured by **Top Device**.

The sequential device addresses from the starting address for the number of configured devices is displayed in **Data List** on the **Data** tab.

The amount of data that can be set varies based on the data type. When **BIN16 (+)**, **BIN16 (+/-)**, or **BCD4** is selected for **Data Type**, up to 8,192 items of data can be configured. When **BIN32 (+)**, **BIN32 (+/-)**, or **BCD8** is selected, up to 4,096 items of data can be configured.

■ Display Type

Selects the display type for **Data** in **Data List** configured on the **Data** tab as **Decimal** or **Hexadecimal**.

Values when saving data to a recipe file are decimal.

● Data Tab

The **Data** tab is used to configure recipe values written to devices.

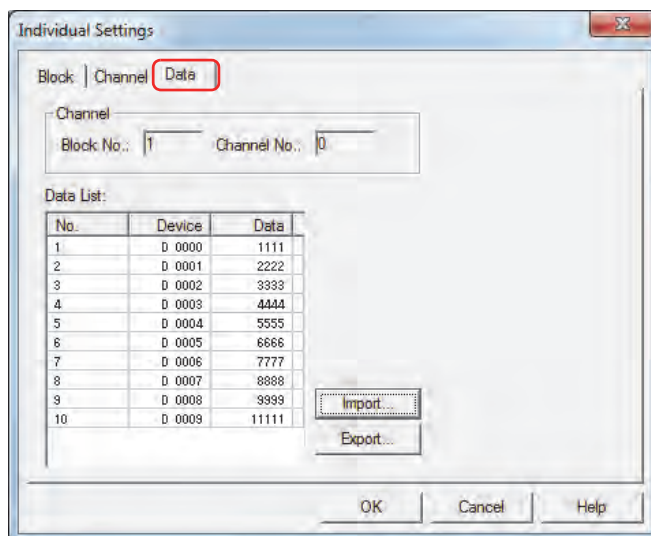

■ Channel

Shows the block number and the channel number for the selected channel.

Block No.: Shows the block number for the channel selected in **Settings**.

Channel No.: Shows the channel number for the channel selected in **Settings**.

■ Data List

Enter the recipe values to write to devices for each number in the selected channel.

No.: Shows the data numbers for the amount of data specified by **Number of Data**.

Device: Devices are sequentially configured starting from the device address specified by **Top Device** on the **Channel** tab.

Data: Double click a cell to enter a recipe value. The value that can be configured varies based on **Data Type** and **Display Type** configured on the **Channel** tab.
When **Read-only** is selected under **Trigger Setting** on the **Block** tab, entering recipe values is unnecessary.

■ Import

Displays the Open dialog box.

Select a recipe file, and then click **Open** to overwrite the data in **Data List** with the selected recipe file.

■ Export

Displays the Save As dialog box.

Select the location to save the recipe file, enter a file name, and then click **Save** to save the recipe file for the selected channel.

The saved recipe file can be edited using Notepad, commercially available text editors, and spreadsheet software.

4 Creating and Deleting Data for Recipes

4.1 Editing Recipe Data

You can export recipe data for the selected channel, edit the recipe values in a saved file, and import a recipe file back into WindO/I-NV3.

- 1 On the **Configuration** tab, in the **System Setup** group, click **Recipe**.

The Recipe Settings dialog box is displayed.

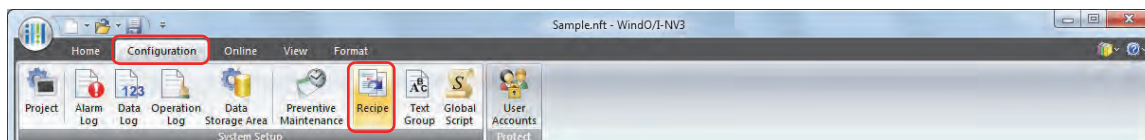

- 2 Select the channel number to export its recipe data in **Settings**, and then click **Edit**.

The Individual Settings dialog box is displayed.

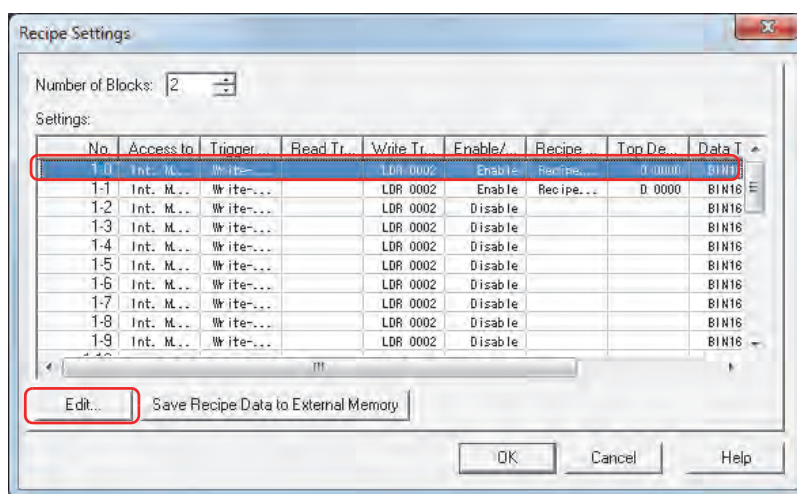

- 3 Click the **Data** tab, and then click **Export**.

The Save As dialog box is displayed.

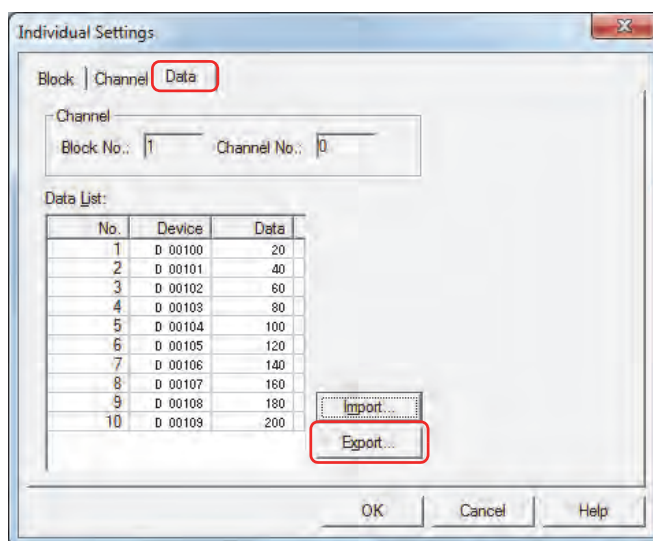

- 4 Specify the save location in **Save in**, and then click **Save**.

The file name specified on the **Block** tab in the Individual Settings dialog box is entered in **File name**.

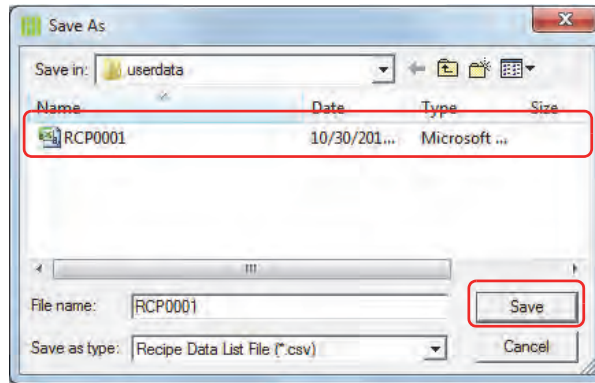

- 5 Open the exported recipe data file.

Use Notepad, a commercially available text editor, or spreadsheet software.

- 6 Edit the values and save the file.

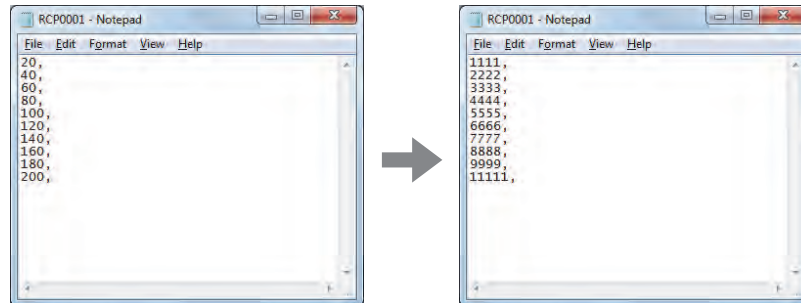

- 7 Return to the **Data** tab in the Individual Settings dialog box, and then click **Import**.

The Open dialog box is displayed.

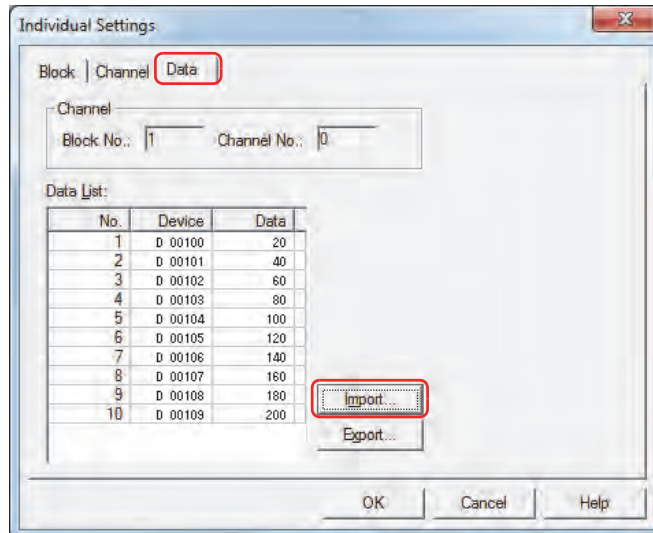

- 8 Specify the file, and then click **Open**.

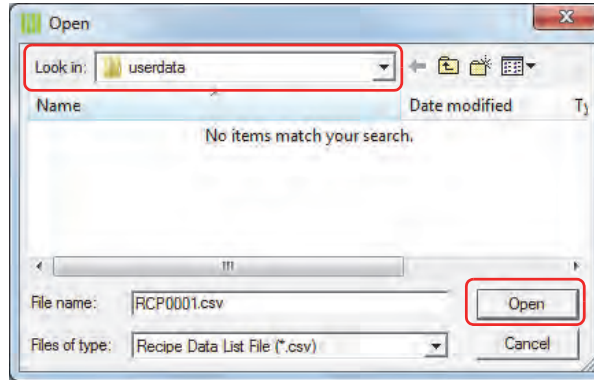

The recipe data is imported.

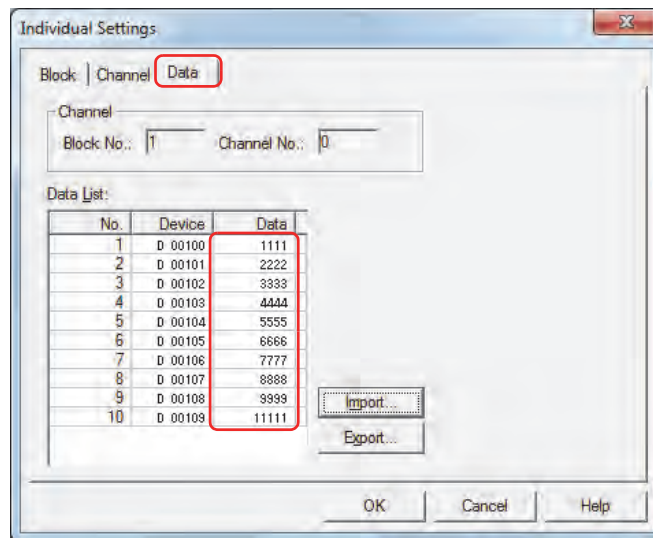

- 9 Click **OK**.

The Individual Settings dialog box closes.

- 10 Click **OK**.

The Recipe Settings dialog box closes.

This concludes editing recipe data.

4.2 Creating Recipe Files

Recipe files can be created on the external memory with the following procedure. The recipe values configured on the **Data** tab in the Individual Settings dialog box are saved in recipe files.

- ☞ “Creating Recipe Files in the Recipe Settings Dialog Box” on page 18-17
- ☞ “Creating Recipe Files when Downloading Project Data” on page 18-19
- ☞ “Creating Recipe Files with a Text Editor” on page 18-20

● Creating Recipe Files in the Recipe Settings Dialog Box

- 1 Insert a USB flash drive in the computer.

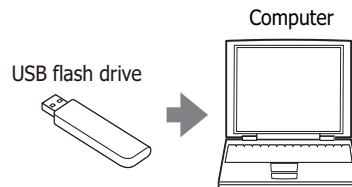

- 2 On the **Configuration** tab, in the **System Setup** group, click **Recipe**.

The Recipe Settings dialog box is displayed.

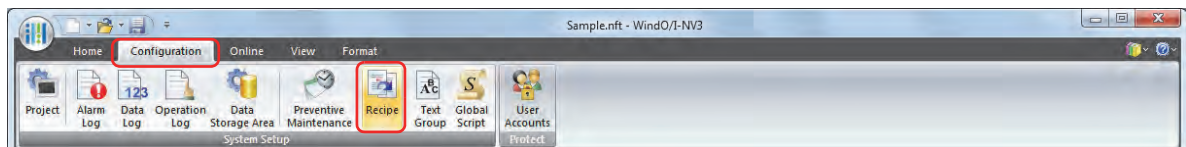

- 3 Click **Write Recipe Files to External Memory**.

The Select Drive dialog box is displayed.

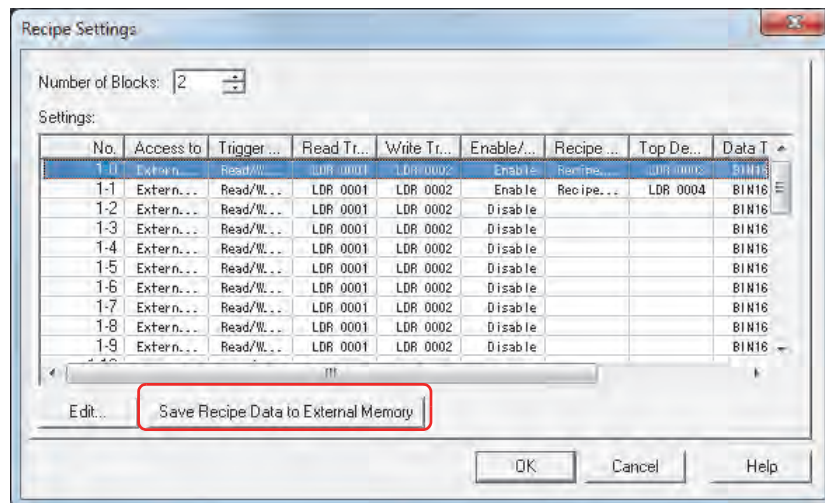

- 4 Specify the drive for USB flash drive, and then click **OK**.

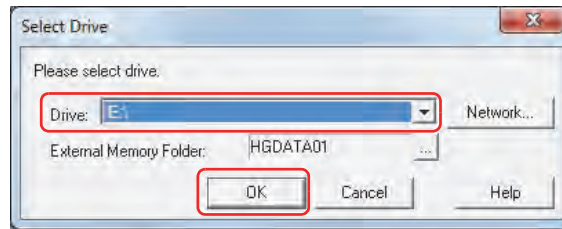

■ **Drive**

Specifies the drive assigned to the external memory.

■ **Network**

Displays the Map Network Drive dialog box. This dialog box allows you to specify a drive on the network.

■ **External Memory Folder**

Specifies the folder to save the created recipe file.

Click to display the Project Settings dialog box. You can specify the External Memory Folder used as the save destination.

- 5 Click **OK**.

The Recipe Settings dialog box closes.

The "RECIPE" folder is created in the External Memory Folder used as the save destination, and the recipe files for the channels configured with **Access to** set to **External Memory** and **Recipe function** set to **Enable** in the Recipe Settings dialog box are created.

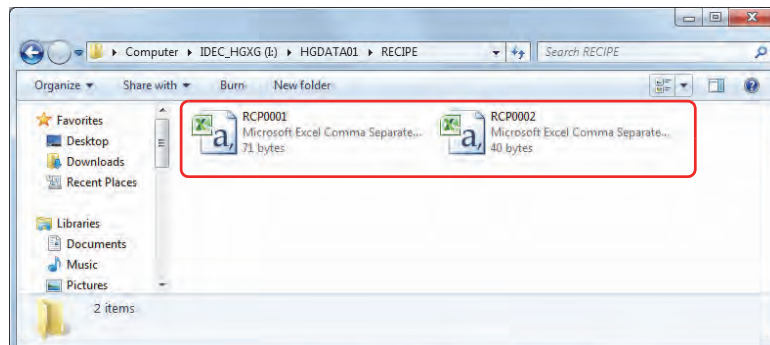

● Creating Recipe Files when Downloading Project Data

When a project download is executed, the "RECIPE" folder is created in the External Memory Folder on the external memory inserted in the Touch and the recipe files are created. The recipe files are only created for channels configured with **Access to** set to **External Memory** and **Recipe function** set to **Enable** in the Recipe Settings dialog box.



The External Memory Folder is configured in the Project Settings dialog box. For details, refer to Chapter 26 "1.5 Setting the External Memory Folder" on page 26-12.

- 1 Insert a USB flash drive into the Touch.

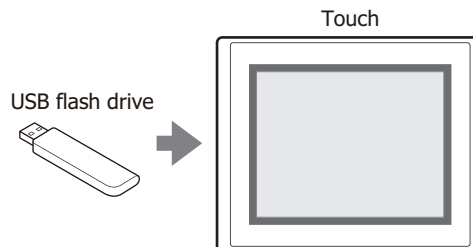

- 2 On the **Home** tab, in the **Project** group, click the **Download** icon.

The Download dialog box is displayed.

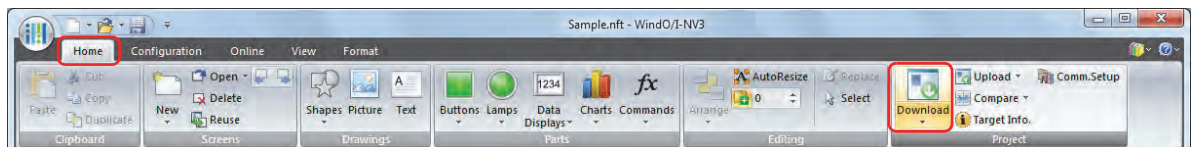

If the project data was changed, a confirmation message to save the project data is displayed.

Click **OK** to save the project data and display the Download dialog box.

Click **Cancel** to stop to save the project data.

- 3 Select the **Download Recipe Files to External Memory** check box.

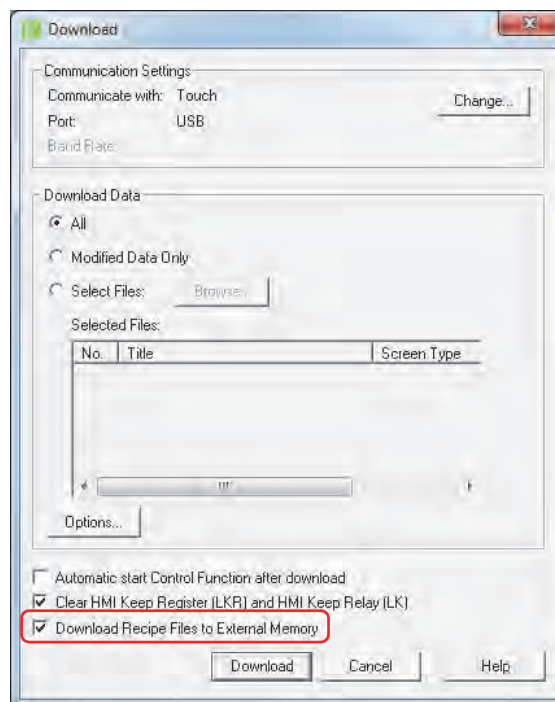

4 Verify **Communication Settings**, and then click **Download**.

Since the recipe files are downloaded to the external memory inserted in the Touch, use the same settings as when communicating with the Touch.

To change **Communication Settings**, click **Change** to display the Communication Settings dialog box. Change **Communicate with**, **Port**, and **Baud Rate**. For details, refer to Chapter 23 "1 Communicating with the Touch" on page 23-1.



If security is enabled in the Touch project, the Password Screen is displayed. Select the user name and enter the password.

For details, refer to Chapter 21 "User Accounts and the Security Function" on page 21-1.

5 Click **Yes**.

The Download Project dialog box is displayed and the project files start downloading. When finished downloading, a completion message is displayed.

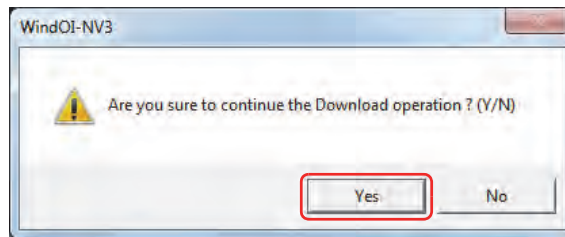

6 Click **OK**.

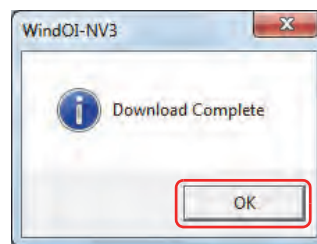

7 Click **Close**.

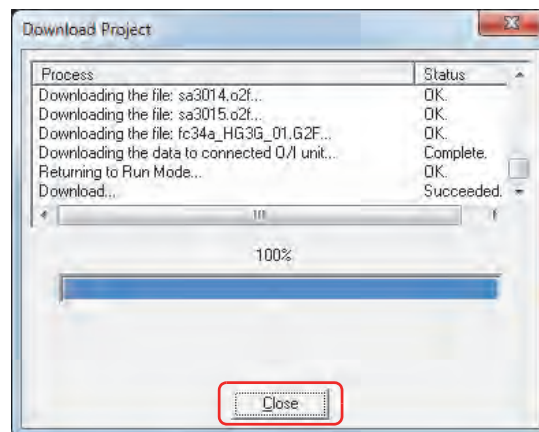

● Creating Recipe Files with a Text Editor

You can edit recipe files using Notepad, commercially available text editors, or spreadsheet software.

1 Write the data for the amount of data in "value of device" comma (,) new line order.

If the amount of data in the recipe file is lower than the amount of data for the top device configured on the **Channel** tab in the Individual Settings dialog box, 0 is written in the rest of the devices.

2 Save the file with the ".csv" extension.

Give the file the file name configured on the **Block** tab in the Individual Settings dialog box. If the file name is different, 0 is written to all the devices.

3 Copy the edited recipe files to the "RECIPE" folder in the External Memory Folder on the external memory.

4.3 Editing Recipe Files

You can read and display the data saved from the Touch to the external memory as a recipe file on a computer.

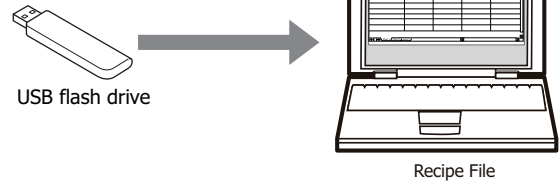

The recipe file that was read can be edited using Notepad, commercially available text editors, or spreadsheet software.



You can upload recipe files from the external memory using WindO/I-NV3.

On the WindO/I-NV3 **Online** tab, click the arrow under **Upload**, and then click **Stored Data in External Memory** to display the Upload Data from External Memory dialog box. Select the **Recipe Files** check box, specify the location to save the recipe files in **Path**, and then click **OK** to be able to save the recipe files in the specified folder.

4.4 Deleting Recipe Files

The methods to delete recipe files saved on the external memory are as follows.

To delete files with WindO/I-NV3, on the **Online** tab, in the **Touch** group, click **Clear**, and then click **Stored Data in External Memory** to display the **Clear Data** in external memory dialog box. Select the **Recipe Files** check box, and then click **OK**.

Chapter 19 Text Group

This chapter describes the Text Group function and how to configure text groups and text.

1 Overview

19

Text Group

1.1 How the Text Group Function is Used

Text groups are a function where the text used for such purposes as registration text, messages for parts, chart labels, and titles for Popup Screens are registered in advance. The registered text is loaded and displayed when displaying parts and screens. The text can be managed collectively including editing the registered text and adding or deleting text.

Text groups can perform the following functions.

- Switch the displayed language by value of device.

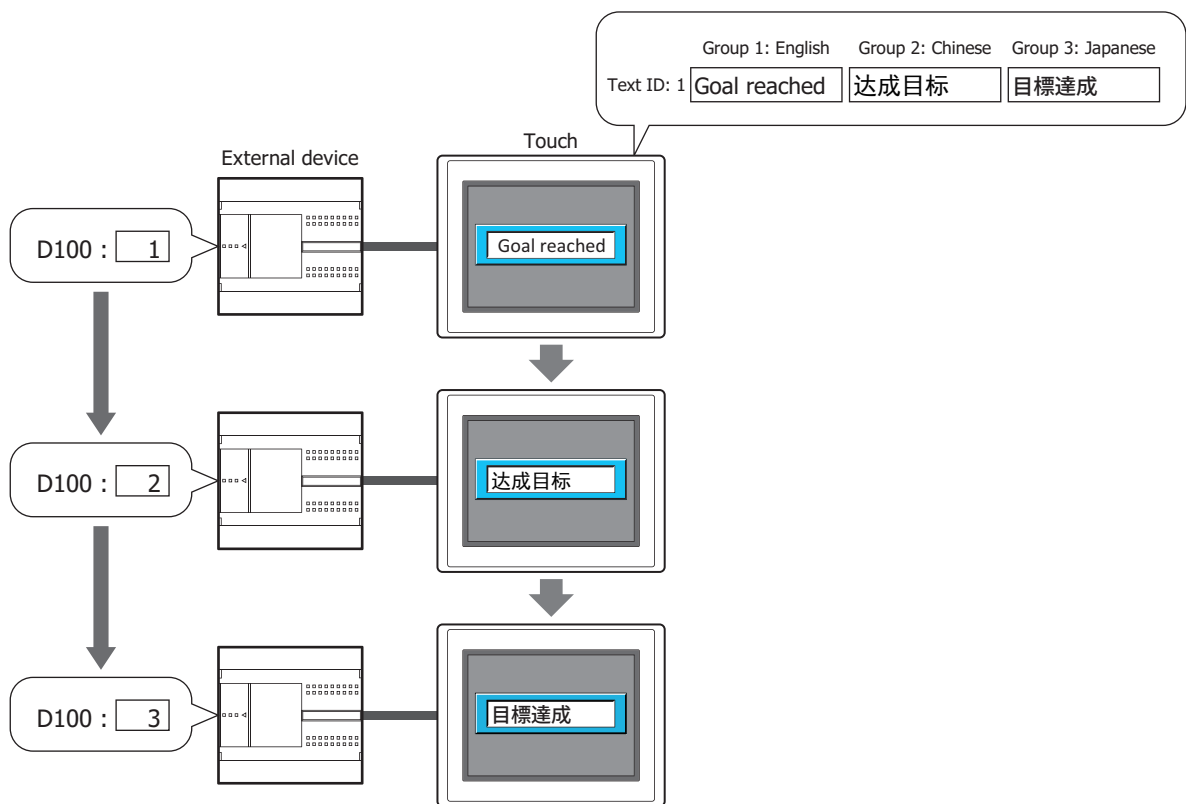

- Use common text for parts.

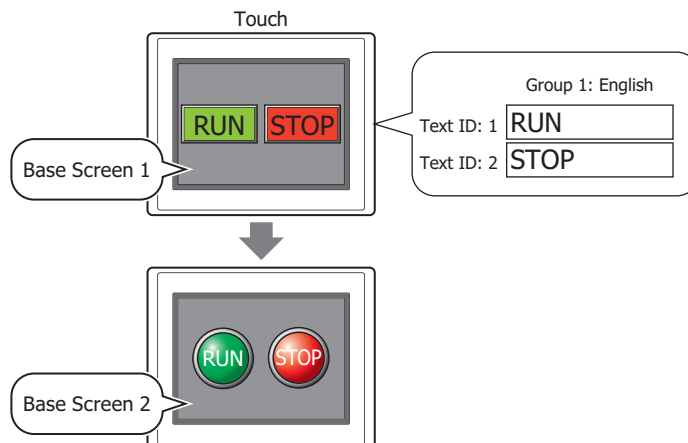

1.2 Functions that Support Text Groups

The functions that support text groups are as follows.

Item		Setting
Screen	Popup Screen	Title
Drawings	Text	Text
Buttons	Bit Button	Registration Text
	Word Button	Registration Text
	Goto Screen Button	Registration Text
	Key Button	Registration Text
	Selector Switch	Registration Text
Lamps	Pilot Lamp	Registration Text
	Multi-State Lamp	Registration Text
Data Displays	Numerical Input	Unit
	Message Display	Message
	Message Switching Display	Message
	Alarm List Display	Message
	Alarm Log Display	Message, Title
	Numerical Display	Unit
Charts	Bar Chart	X-axis and Y-axis scale labels
	Line Chart	X-axis and Y-axis scale labels
Alarm Log		Messages displayed in data output as CSV
Data Log		Labels displayed in data output as CSV
Operation Log		Recorded item labels and event names displayed in data output as CSV



When the text group is switched, the displayed Base Screen is reset. Popup Screens and internal devices have the same behavior as when the Base Screen is switched. If the **Close while changing Base Screen** check box is selected on the **Options** tab in the properties dialog box for the Popup Screen, the displayed Popup Screen is closed. The behavior of the internal devices differs according to the internal devices. For details, refer to Chapter 27 "Internal Devices" on page 27-1.

2 Text Groups and Text Configuration Procedure

This section describes the configuration procedure for text groups and text.

2.1 Creating Text Groups

- 1 On the **Configuration** tab, in the **System Setup** group, click **Text Group**.

The Text Group Settings dialog box is displayed.

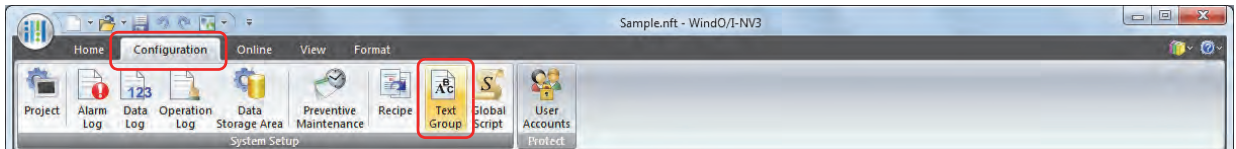

- 2 In **Number of Text Groups**, specify the number of text groups to create (1 to 16).

The configured number of text groups are enabled.

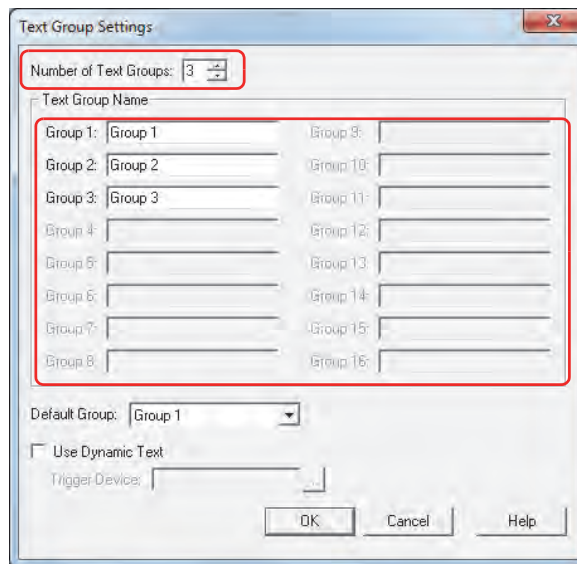

- 3 Under **Text Group Name**, enter the name for each text group.

The maximum number for the Text Group name is 20 characters.

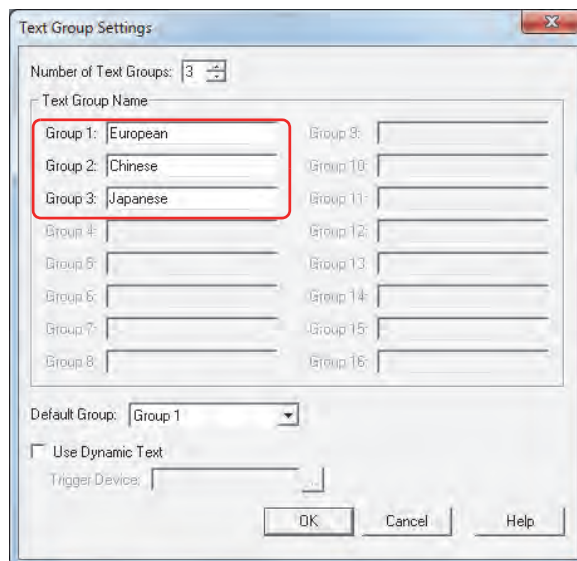

For one text group, proceed to step 7.

- 4 In **Default Group**, select the text group to use when the Touch power is turned on and when switched to run mode.
- 5 Select the **Use Dynamic Text** check box.
- 6 With **Trigger Device**, specify the word device to use as the condition to switch the text group.

Click  to display the Device Address Settings dialog box. For the device address configuration procedure, refer to Chapter 2 "5.1 Device Address Settings" on page 2-61.

These options can only be configured when **Number of Text Groups** is specified as two or more.



When the value of device is 0, the text group switches to the default group.

If the value of device is invalid, the text group is not switched.

- 7 Click **OK** to close the Text Group Settings dialog box.

This concludes creating text groups.

2.2 Registering Text

- 1 On the **View** tab, in the **Workspace** group, click  (Text Manager).
Text Manager is displayed.

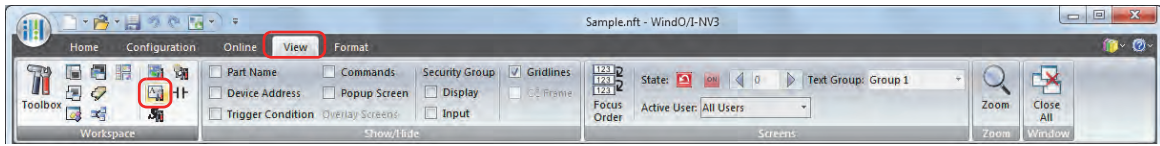

- 2 With **Text Group**, select the text group to register text to.

The default is "1-Group 1" only. To manage text by groups, create the groups in the Text Group Settings dialog box. Click  to display the Text Group Settings dialog box. For details, refer to "Text Group Settings Dialog Box" on page 19-15.

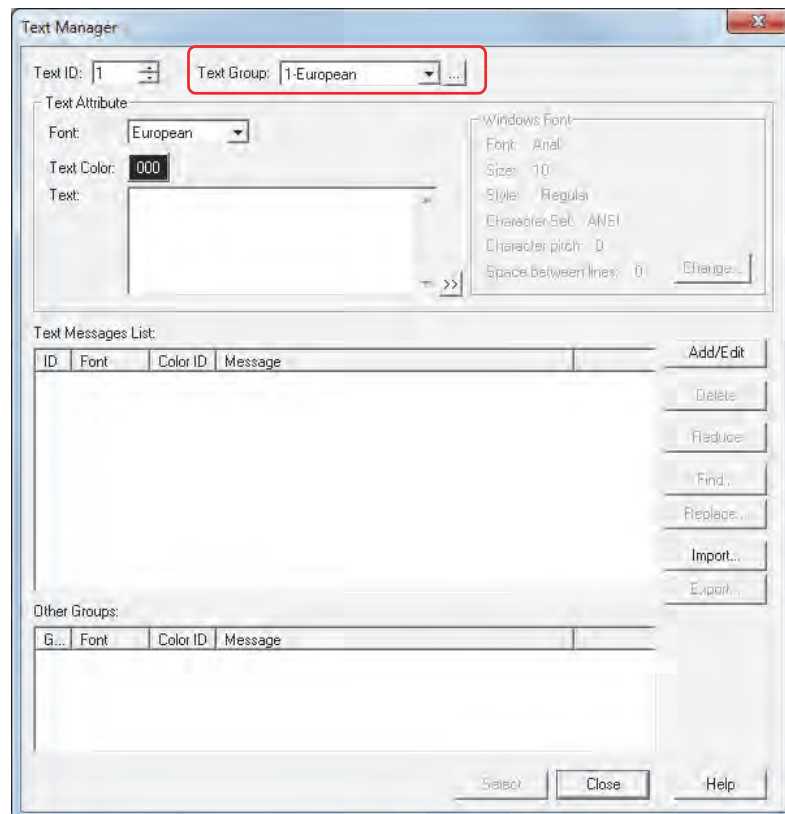

- 3 With **Text ID**, specify the ID number to register (1 to 32,000).
- 4 With **Font** under **Text Attribute**, select the font to use for the text to register from the following.
European, Japanese, Chinese, Taiwanese, Korean, Central European, Baltic, Cyrillic, Windows



When **Windows** is selected, all the fonts installed on the computer can be used. This allows you to display fonts and languages that are not installed on the Touch.

Click **Change** to display the Font Settings dialog box. Configure the details such as the font, style, and size. For details, refer to Chapter 2 "Windows Font" on page 2-12.

- 5 With **Text Color** under **Text Attribute**, select the color of the text to register (color: 256 colors, monochrome: 8 shades).
Click **Color** to display the Color Palette. Select a color from the Color Palette.

6 In **Text** under **Text Attribute**, enter the text to register.

The maximum number is 3750 characters.

The characters that can be entered vary based on the font selected by **Font**. For details, refer to Chapter 2 "1.2 Available Text" on page 2-5.



- You can enter multi-line text by inserting a newline. The newline is displayed as \n and is counted as two characters.
 - To enter Unicode characters, click  to display the Unicode Input dialog box. Enter the characters in the Unicode Input dialog box, and then click **OK**.
-

7 Click **Add/Edit**.

The text is registered and displayed in the text list.

8 Repeat steps **2** through **7** to create the necessary text in each text group.

9 Click **Close**.

A save confirmation message is displayed.

10 Click **OK**.

The confirmation message and Text Manager close.

This concludes registering text.

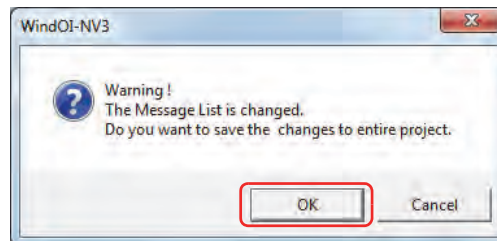

- Saving Registered Text as a CSV File

To use registered text in another project, save the text as a CSV file or as a text file. This file is called a text list.

- 1 On the **View** tab, in the **Workspace** group, click  (Text Manager).

Text Manager is displayed.

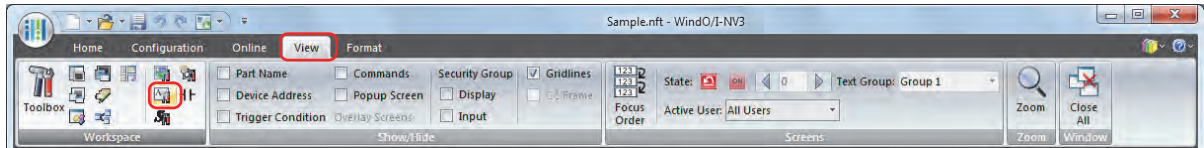

- 2 With **Text Group**, select the text group where the text ID to save is registered.

For one text group, proceed to step 3.

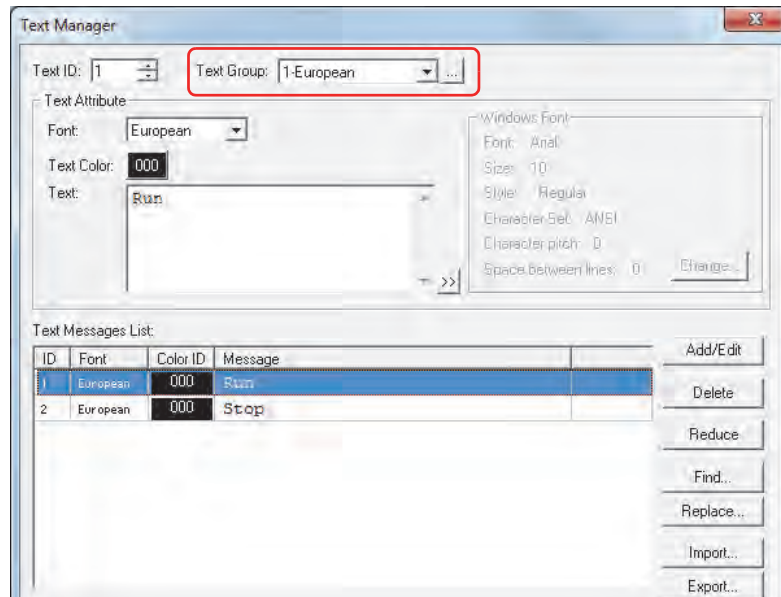

- 3 Click **Export**.

The Save As dialog box is displayed.

- 4 Select **Save in**, enter **File name**, and then click **Save**.

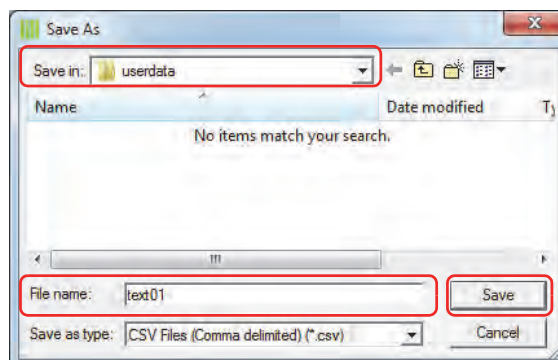

- 5 Click **Close** to close Text Manager.

This concludes saving a text list.

● **Importing Text from a Text List**

A text list saved as a CSV file or as a text file can be imported into Text Manager for the project being edited.

- 1 On the **View** tab, in the **Workspace** group, click  (Text Manager).

Text Manager is displayed.

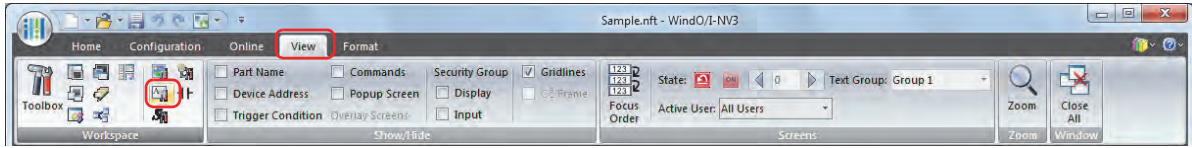

- 2 With **Text Group**, select the text group to register the imported text to.

For one text group, proceed to step 3.

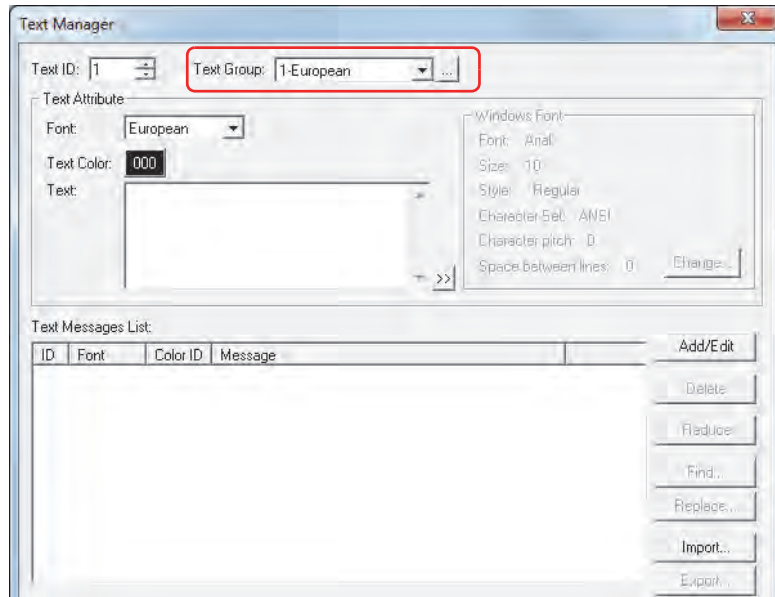

- 3 Click **Import**.

The Text Message List dialog box is displayed.

- 4 Click **List File**.

The Open dialog box is displayed.

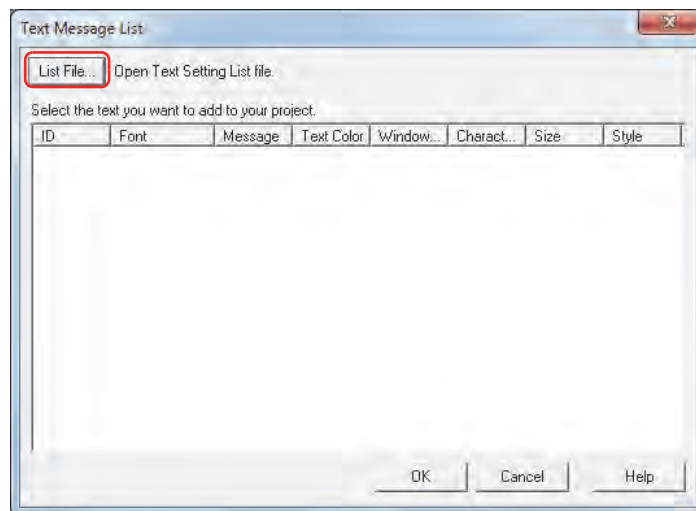

- 5 Select a saved text list, and then click **Open**.

The text is displayed in the list.

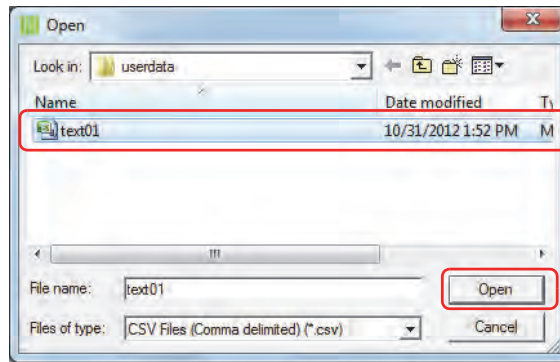

- 6 Click the text to import.



To select multiple items of text, press and hold SHIFT or CTRL while you click the specific items.

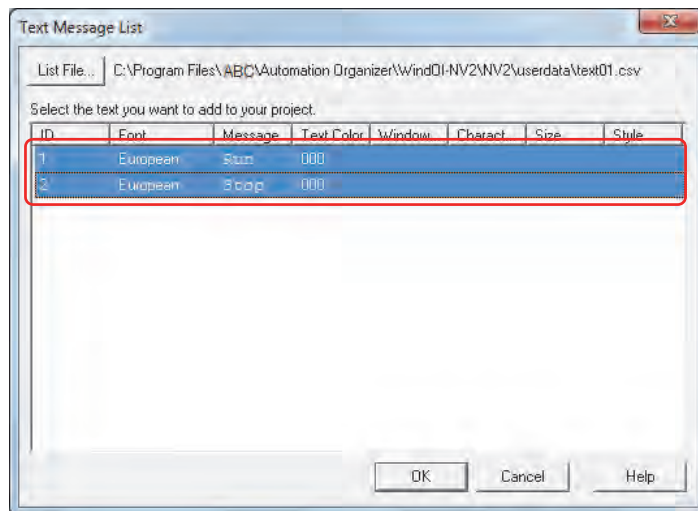

- 7 Click **OK**.

If there is text with an already registered ID number in Text Manager, a confirmation message to overwrite that text is displayed.

- Click **Yes** to overwrite the text with the ID number displayed in the confirmation message.
- Click **Yes To All** to overwrite all the text.
- Click **No** to display the next confirmation message without overwriting the text with the ID number displayed in the confirmation message.
- Click **Cancel** to stop importing text.

- 8 Click **Close** in Text Manager.

A save confirmation message is displayed.

- 9 Click **OK**.

The confirmation message and Text Manager close.

This concludes importing text from a text list.

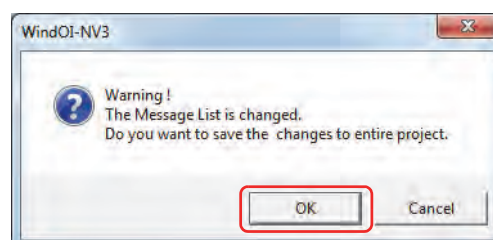

2.3 Switching the Displayed Language by Value of Device

When multiple text groups have been created, the text group can be switched with a value of device to display a different language.

This section describes an example when the registration text for a button changes between English, Chinese, and Japanese.

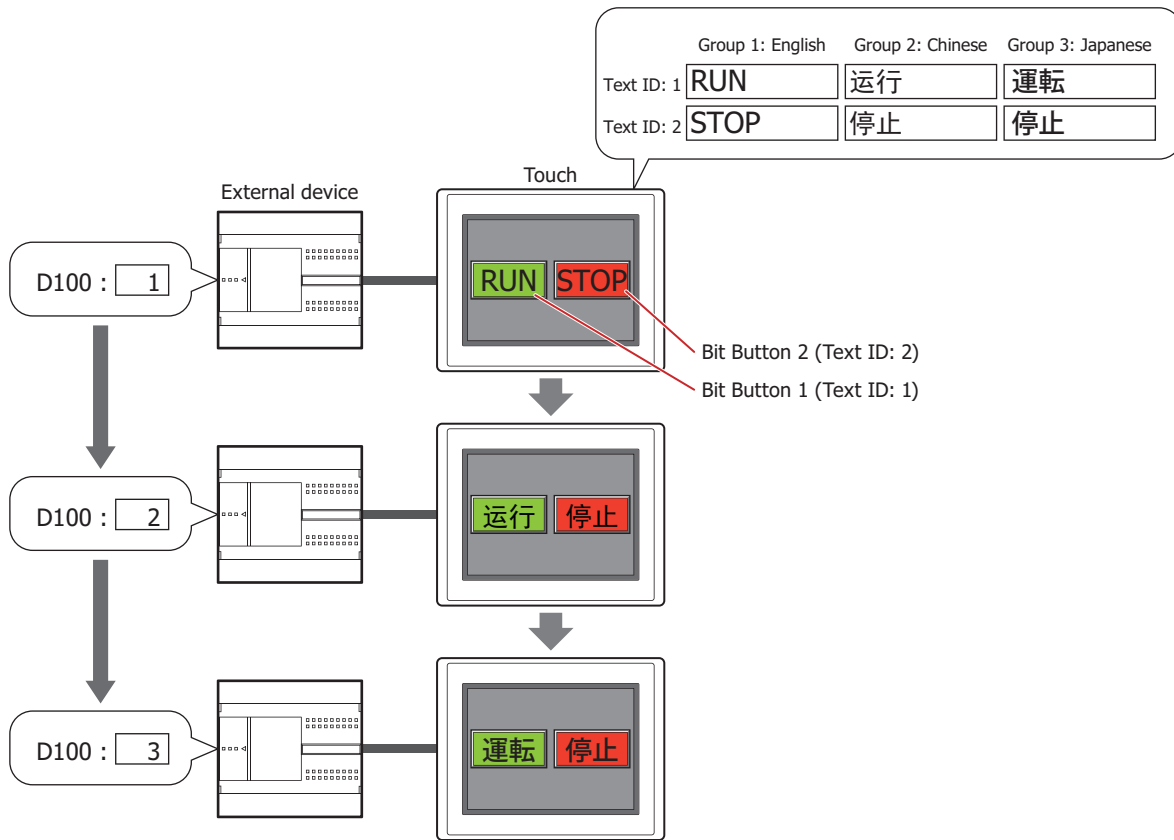

- 1 Following the steps in “Creating Text Groups” on page 19-3, specify **Number of Text Groups** as 3, and under **Text Group Name**, enter “English” for **Group 1**, “Chinese” for **Group 2**, and “Japanese” for **Group 3**. Select the **Use Dynamic Text** check box and set **Trigger Device** to D100.
- 2 Following the steps in “Registering Text” on page 19-5, register the text.

	Group 1: English	Group 2: Chinese	Group 3: Japanese
Text ID: 1	RUN	运行	運転
Text ID: 2	STOP	停止	停止

- 3 Create a Bit Button.
On the **Home** tab, in the **Parts** group, click **Buttons**, and then click **Bit Button**.

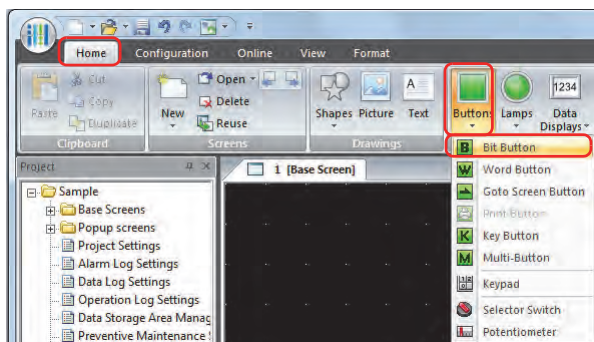

- 4 Click a point on the edit screen where you want to place the Bit Button.

- 5 Double-click the dropped Bit Button and the properties dialog box is displayed.

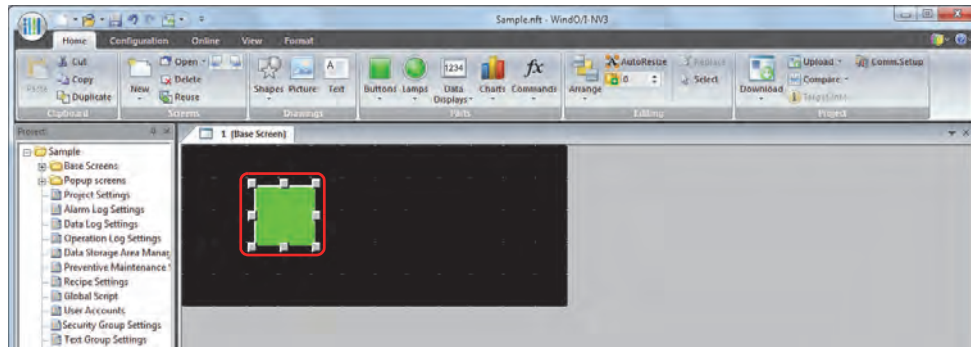

- 6 Click the **Registration Text** tab.

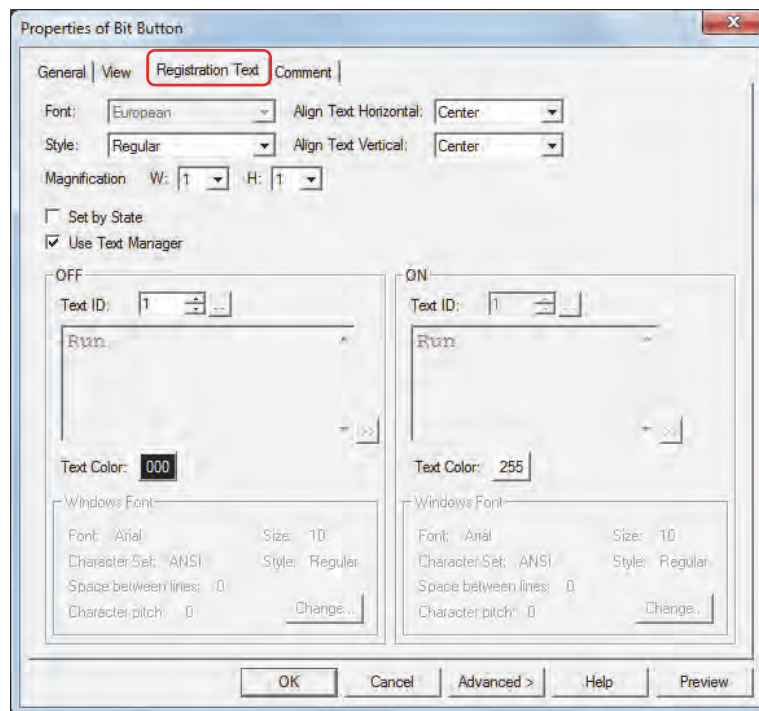

- 7 Select the **Use Text Manager** check box.
- 8 Specify 1 for the **Text ID** under **OFF**.
- 9 Configure the settings on each tab as necessary, and then click **OK**.
The Properties of Bit Button dialog box closes.
- 10 Repeat steps 3 through 9 and create a Bit Button to use text ID 2 for the registration text.
This concludes configuring the settings to switch the displayed language by a value of device.

3 Text Manager

This section describes items and buttons in Text Manager and on the Text Group Settings dialog box.

3.1 Text Manager

The text that is loaded and displayed when objects and Popup Screens are displayed is collectively managed with Text Manager.

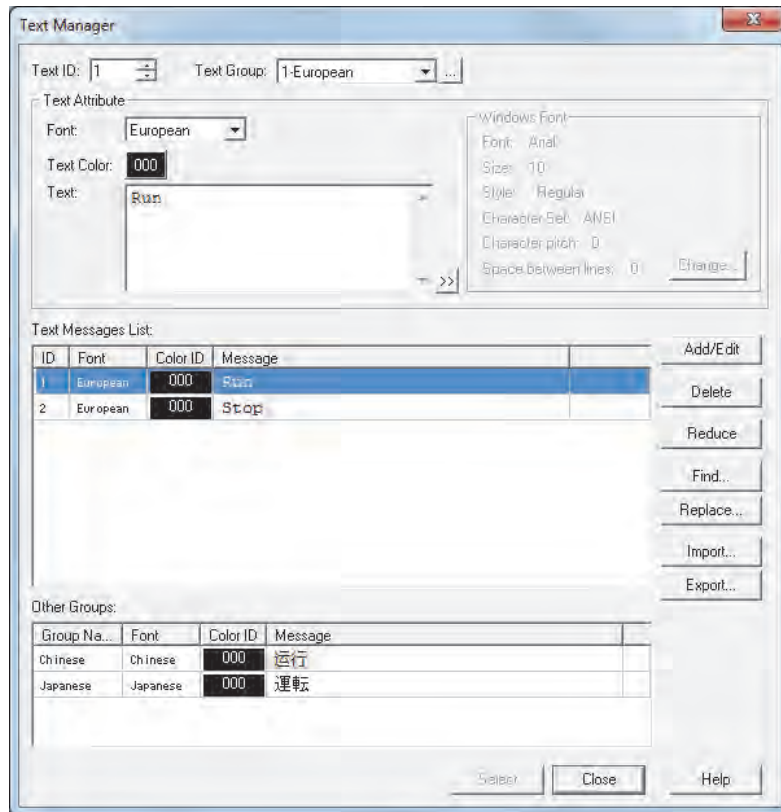

■ Text ID

Shows the ID number (1 to 32,000).

When registering text, specify the ID number to register (1 to 32,000).

When using registered text when displaying parts and screens, specify the ID number to use (1 to 32,000).

■ Text Group

Selects the group where text is registered.

The default is "1-Group 1" only. To manage text by groups, create the groups in the Text Group Settings dialog box.

Click to display the Text Group Settings dialog box. For details, refer to "Text Group Settings Dialog Box" on page 19-15.

■ Text Attribute

This area configures the text to register and the font and color for the text.

Font: Selects the font used for displaying text from the following.

European, Japanese, Chinese, Taiwanese, Korean, Central European, Baltic, Cyrillic, Windows

Text Color: Selects the color of the text to register (color: 256 colors, monochrome: 8 shades).

Click **Color** to display the Color Palette. Select a color from the Color Palette.

Text: Enter the text to register here. The maximum number is 3,750 characters.

The characters that can be entered vary based on the font selected by **Font**. For details, refer to Chapter 2 "1.2 Available Text" on page 2-5.

Windows Font: Sets the font to be used as the Windows Font. Select **Windows** using **Font** to display the current setting. To change the setting, click **Change** to display the Font Settings dialog box. For details, refer to Chapter 2 "Windows Font" on page 2-12.



- You can enter multi-line text by inserting a newline. The newline is displayed as \n and is counted as two characters.
- To enter Unicode characters, click  to display the Unicode Input dialog box. Enter the characters in the Unicode Input dialog box, and then click **OK**.

■ Text Messages List

The attributes for the registered text are displayed in this list.

ID: Shows the ID number (1 to 32,000).
Font: Shows the font to use to display the registered text.
Color ID: Shows the color ID for the registered text (color: 256 colors, monochrome: 8 shades).
Message: Shows the registered text.

■ Add/Edit

Registers the settings in **Text Attribute** to the ID number specified by **Text ID**. When you specify an ID number that is already registered, that ID number is overwritten with the new settings. The registered text and its attributes are displayed in the **Text Messages List**.

■ Delete

Deletes the text with the ID number selected in the **Text Messages List**. Click this button and the Confirm Message Delete Dialog dialog box is displayed.

- Click **Yes** to delete the text with the ID number displayed in the confirmation message from all the text groups.
- Click **Yes To All** to delete the text for all the ID numbers selected in the **Text Messages List** from all the text groups.
- Click **No** to display the next confirmation message without deleting the text with the ID number displayed in the confirmation message.
- Click **Cancel** to stop deleting the text.



To select multiple items of text, press and hold SHIFT or CTRL while you click the specific items.

■ Reduce

Deletes the text with ID numbers that are registered in the Text Message List but are not used in the project. This can decrease the amount of project data and reduce the amount of internal memory used on the Touch.

■ Find

Displays the Find dialog box.

The text entered in **Find what** is searched for in **Message** in the **Text Messages List**.

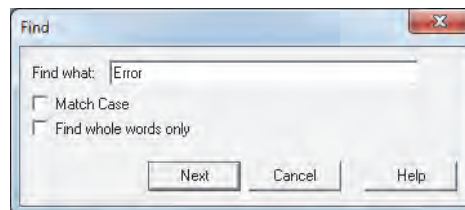

When **Find** is clicked after selecting a range of text, it will only search within the selected range. To select multiple items of text, press and hold SHIFT or CTRL while you click the specific items.

■ Replace

Displays the Replace dialog box.

The text entered in **Find what** is searched for in **Message** in the **Text Messages List** and that text is replaced with the text entered in **Replace with**.

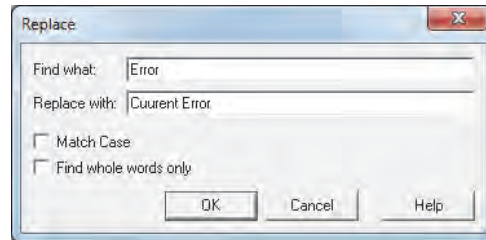

When **Replace** is clicked after selecting a range of text, it will only search and replace within the selected range.

To select multiple items of text, press and hold SHIFT or CTRL while you click the specific items.

■ Import

Imports text in a text list saved as a CSV file or as a text file.

Click this button to display the Text Message List dialog box. For details, refer to “Importing Text from a Text List” on page 19-8.

■ Export

Saves the text for the text group being edited as a CSV file or as a text file. This file is called a text list. The types of files that can be saved are as follows.

- CSV file (comma delimited) (*.csv)
- CSV file (semicolon delimited) (*.csv)
- Text file (comma delimited) (*.txt)
- Text file (semicolon delimited) (*.txt)
- Unicode text file (tab delimited) (*.txt)

Click this button to display the Save As dialog box. For details, refer to “Saving Registered Text as a CSV File” on page 19-7.

The saved text list can be imported with **Import**.



When **Unicode text file (tab delimited) (*.txt)** is selected, the file can handle multiple languages by using a commercially available text editor or spreadsheet software that supports Unicode.

■ Other Groups

When text with the same ID number as the text selected in the **Text Messages List** is registered to other text groups, that text is displayed in this list.

Group Name:	Shows the group name.
Font:	Shows the font for the registered text.
Color ID:	Shows the color ID for the registered text (color: 256 colors, monochrome: 8 shades).
Message:	Shows the registered text.

■ Select

Closes Text Manager and sets the ID number selected in Text Manager **Text Messages List** in the dialog box or screen that opened Text Manager. This button is only enabled when Text Manager was called from the properties dialog box of an object.

■ Close

Closes Text Manager.



When Text Manager was called from the properties dialog box of an object, **Add/Edit**, **Delete**, **Reduce**, **Replace**, **Import**, and **Export** are disabled. These buttons are only enabled when Text Manager is displayed with the following operations.

- Double click **Text Manager** in the **Project** window
- On the **View** tab, in the **Workspace** group, click  (Text Manager)

3.2 Text Group Settings Dialog Box

The groups for switching text are managed in the Text Group Settings dialog box.

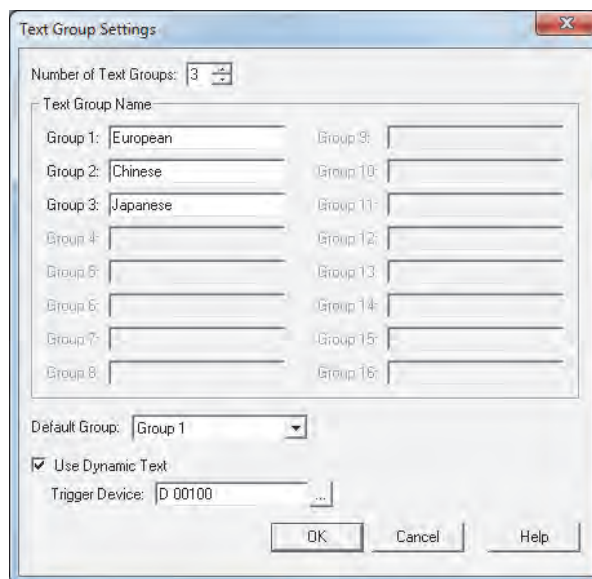

■ Number of Text Groups

Specifies the number of text groups (1 to 16). The configured number of text groups are created.

■ Text Group Name

Enters the names of the text groups.

The maximum number for the Text Group name is 20 characters.

■ Default Group

Select the group to use when the Touch power is turned on and when switching to run mode.

■ Use Dynamic Text

Select this check box to switch the text group according to the value of device.

Specify the word device to use as the condition to switch the text group.

Click  to display the Device Address Settings dialog box. For the device address configuration procedure, refer to Chapter 2 "5.1 Device Address Settings" on page 2-61.

These options can only be configured when **Number of Text Groups** is specified as two or more.



When the value of device is 0, the text group switches to the text group set as the default group.

If the value of device is invalid, the text group is not switched.

This chapter describes the script function, editing and management of the script, definition method, and definition sample.

1 About the Script Function



1.1 Overview of the Script Function

● What is the script function?

Complex processes such as conditional branching, logical operation, arithmetic operation, functions, etc., can be programmed in a text format using Script Function.

The scripts can be executed in a Script Command, a Global Script, a ladder program, or a FBD program.

For ladder program and FBD program details, refer to the following.

- Ladder program: SCRPT instruction
 "SmartAXIS Ladder Programming Manual" - Chapter 27 "Script"
- FBD program: Script FB
 "SmartAXIS FBD Programming Manual" - Chapter 17 "The script FB"

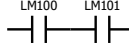
As an example, the logical product (AND) calculation described as  in a ladder diagram is described as `[LM 100] & [LM 101]` in text format in the script.

■ Description and management of the script

The script is programmed by WindO/I-NV3 script editor, and managed by Script Manager.



- By using the Script Editor, conditional expressions, operators, and functions can be described by selecting them from a list, and an error in the script can also be determined. The script can also be exported as a text file, so the script can be edited by a text editor such as Notepad, and the edited script can be imported back into the Script Editor by saving it as a text file.
 For details, refer to "2.3 Script Editor" on page 20-8.
- Script Manager can manage the script collectively by adding, deleting, organizing, etc., the script created by the Script Editor.
 For details, refer to "2.2 Script Manager" on page 20-7.

■ Example of using the script

As an example, when reading the data from the external device and displaying on the Touch, the load on the external device can be reduced for processes such as conditional branching or function calculation, which apply a heavy load on the external device, by processing it with a script on the Touch.

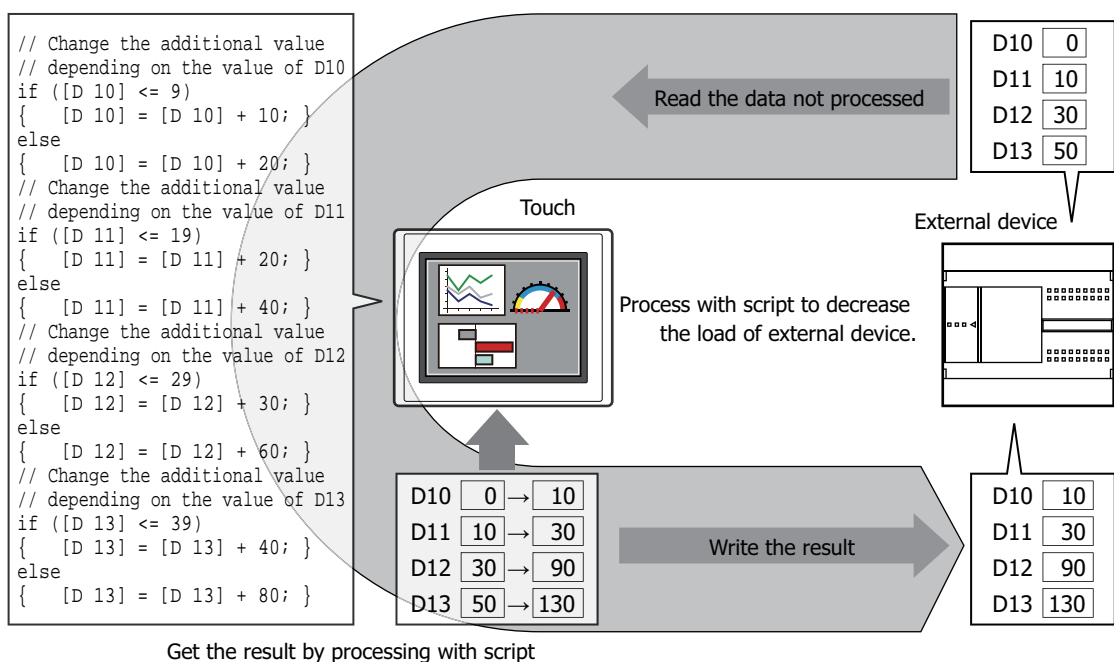

1.2 Types and Trigger Conditions of the Script for HMI Function

● Types of scripts

There are two types of scripts used.

■ Script Command

This is a script that executes in accordance with trigger conditions in the same way as other parts, such as buttons or lamps, for each screen.

- It is executed only in the screens where it is placed.
- Multiple scripts can be set for each screen.

For details, refer to Chapter 11 “4 Script Command” on page 11-25.

■ Global Script

This is a script that operates within the whole project. This script is executed at the end of Touch scan process in accordance with the trigger condition.

Only one global script can be set to a project.

For details about setup, refer to “3 Global Script” on page 20-12.

● Trigger condition of the script

Trigger conditions that can be set for the script are as follows:

Script	Trigger Condition					
	Rising-edge	Falling-edge	Satisfy the condition	While satisfying the condition	Fixed Period	Always ON
Script Command	YES	YES	YES	YES	YES	NO
Global Script	YES	YES	NO	NO	YES	YES

■ Rising-edge

Script is executed when trigger device changes from 0 to 1.

■ Falling-edge

Script is executed when trigger device changes from 1 to 0.

■ Satisfy the condition

Script is executed when the set condition is met.

This can only be set for the Script Command.

■ While satisfying the condition

Script is executed while the set condition is met.

This can only be set for the Script Command.

■ Fixed Period

Script is executed at set intervals.

■ Always ON

Script is executed on every scan of the Touch.

This can only be set for the Global Script.

1.3 Data Type of the Script

It is required to set the data type appropriate for the range of data to be used, such as the maximum and minimum values of the data used in the script, negative numbers or real numbers required, etc., considering what is to be processed with the script.



Data type is set by the Script Editor.

For the setting method, refer to "2.3 Script Editor" on page 20-8.

● Data Types

There are seven types of data that can be processed by the script function.

For details about the data types, refer to Chapter 2 "1.1 Available Data" on page 2-1.

Types of the data type	Required word count	Range that can be processed
BIN16 (+)	1	0 to 65535
BIN16 (+/-)	1	-32768 to 32767
BIN32 (+)	2	0 to 4294967295
BIN32 (+/-)	2	-2147483648 to 2147483647
BCD4	1	-999 to 9999
BCD8	2	-9999999 to 99999999
float32	2	-3.4×10 ³⁸ to -1.18×10 ⁻³⁸ 0 1.18×10 ⁻³⁸ to 3.4×10 ³⁸



There are functions that cannot be used when the data types are different. Please refer to the format list.

☞ For details, refer to "4 Script Definition Method" on page 20-14.



WindLDR data types are displayed as follows: BIN16(+) as W (word), BIN16(+/-) as I (integer), BIN32(+) as D (double word), BIN32(+/-) as L (long), and float32 as F (float). For details, refer to the follows:

- Ladder program

☞ "SmartAXIS Ladder Programming Manual" - Chapter 4 "Instructions Reference" - "Data Types for Advanced Instructions"

- FBD program

☞ "SmartAXIS FBD Programming Manual" - Chapter 4 "FB Reference" - "Data types"

1.4 Script Error of HMI Function

This section describes the types, cause, and information of script errors.

● Types and causes of script errors

Script will stop running when an error occurs.

Types of script error	Cause
Processing error	Dividend was divided by 0 for division and residue calculation.
	Data types are BCD, float32, and value out of range is specified.
Execution time over error	The execution time for one script exceeded 3,000 milliseconds.
Writing count error	Data count written to the external device address in one script has exceeded 64.
Indirect device error	Indirect read from external device address is performed while the HMI Special Internal Relay LSM14 or LSM15 is 1.
	Indirect read or indirect write of external device address is performed with the Global Script.
Parameter error	Value out of range was specified as argument for LINE function, RECTANGLE function, or CIRCLE function.

● Error information

Script error information is stored in the following locations. An error message is displayed on the screen when a script error has occurred.

Category	Storage location	Stored value	
Existence of a script error	Bit 10 of the System Area address +2	0	No error
		1	Error
Script ID of the script with an error	HMI Special Data Register LSD52	1 to 32,000	Script ID
Types of script errors	HMI Special Data Register LSD53	1	Processing error
		2	Execution time over error
		3	Writing count error
		4	Indirect device error
		5	Parameter error



- If there is a script error, bit 10 (11th bit) of the starting device +2 (third word from the beginning) of the System Area will be 1.

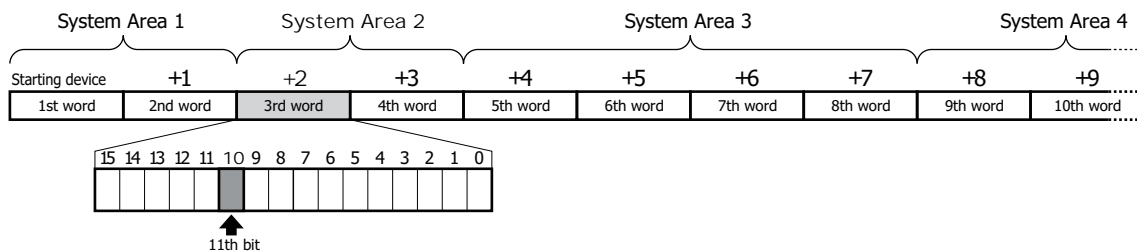

The starting device of the System Area is set in the **System** tab of the Project Settings dialog box. For details about the System Area, refer to Chapter 3 “System Area” on page 3-23.

- For ladder program and FBD program errors, refer to Chapter 30 “2.2 Program Execution Error” on page 30-5.

2 Editing and Management of the Script

2.1 Script Registration Procedure

This section describes the procedure to create a script and register it in the project.

The registered script can be used in a Multi-Button, Script Command, Multi-Command and Global Script.

- 1 On the **View** tab, in the **Workspace** group, click  (Script Manager).

Script Manager opens.

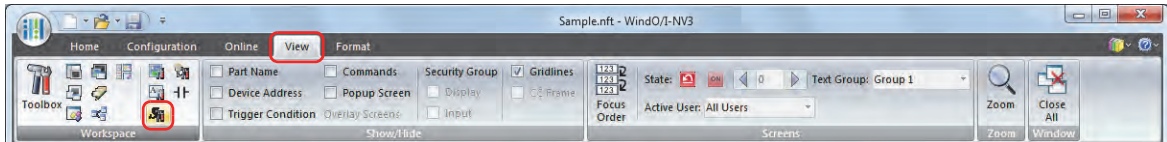

- 2 Click **Add**.

Script Editor opens.

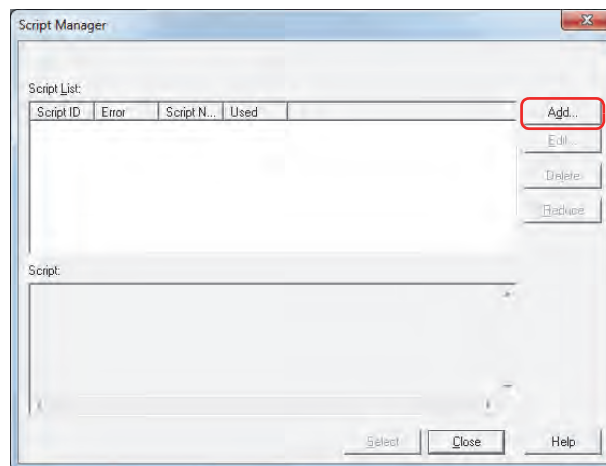

- 3 Specify **Script ID**.

When creating a new script, enter the script ID (1 to 32000).

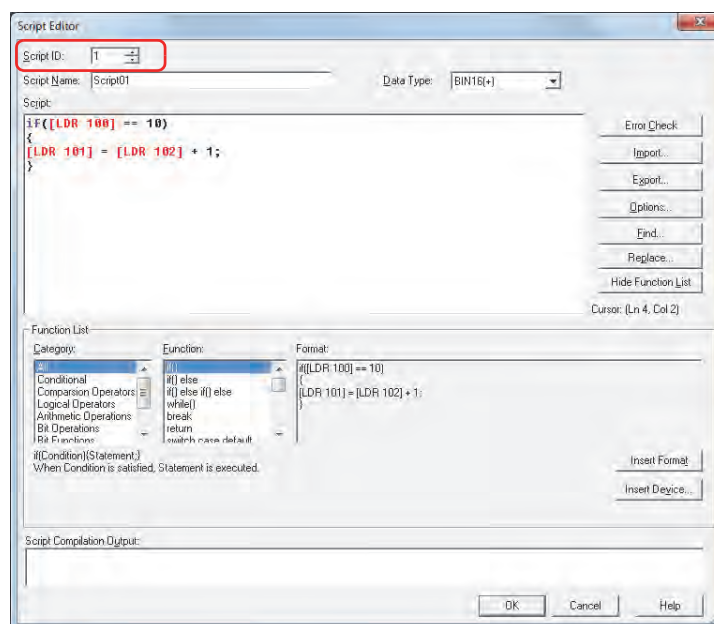

4 Enter **Script Name**.

The maximum number for the script name is 40 characters.

5 Select **Data Type**.

Be sure to match the Data Type of the script with the types of data being used within the script.

For example, if the script contains numbers with decimals, the Data Type of the script would be **float32**. If the script contains only whole numbers between 0 and 65535, the Data Type of the script would be **BIN16(+)**.

6 Type in a program to **Script**.

To create a script using the samples provided by WindO/I-NV3, under **Function List**, select **Category** and **Function**, and then click **Insert Format**. The sample shown in **Format** is inserted at the cursor position in **Script**.

7 When the script is finished, click **OK**.

The created script is shown in **Script List**.

8 Click **Close** on Script Manager.

A save confirmation message is displayed.

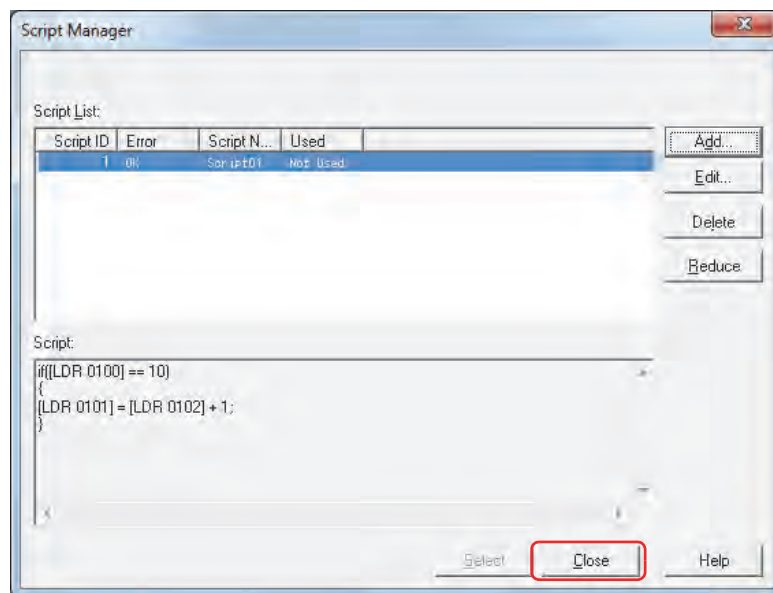
**9** Click **OK**.

The scripts are saved in the project data and Script Manager closes.

If you click **Cancel**, Script Manager closes without saving the scripts.

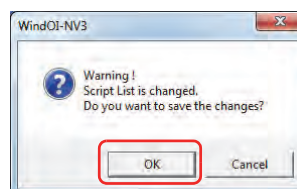

When you are in the following dialog boxes, clicking  will open Script Manager. When you close Script Manager, you will be taken back to the original dialog box.

- Global Script **General** tab
- Script Command properties **General** tab
- Multi-function script properties for Multi-Buttons and Multi-Commands

2.2 Script Manager

Script Manager can add, delete and manage the script created by Script Editor.

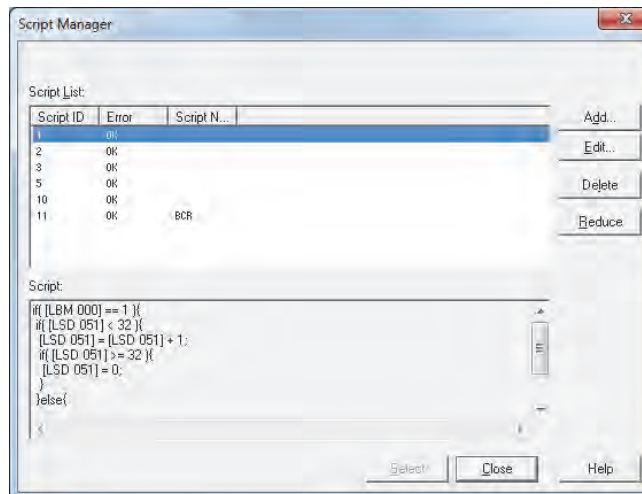

■ Script List

Displays a list of registered scripts.

Script ID: Displays the script ID (1 to 32,000) of the registered scripts.

Error: OK is displayed when there is no error in the registered script and NG is displayed when there is an error.

Script Name: Displays the script name of the registered scripts.

■ Script

Displays the contents of the script selected in the script list.

■ Add

Displays the Script Editor dialog box to add a script.

For details, refer to "2.3 Script Editor" on page 20-8.

■ Edit

Displays the Script Editor dialog box to allow editing of the selected script. For details, refer to "2.3 Script Editor" on page 20-8.

■ Delete

Deletes the script selected in the script list.

If a script is used in a project or parts, it cannot be deleted.

■ Reduce

Deletes the scripts that are registered in the script list but are not used in the project.

■ Select

The highlighted script in the script list is selected and Script Manager is closed.

■ Close

Closes Script Manager.



When **Close** is clicked after a change has been made in the script list, a confirmation message to save is displayed. The change will be saved when **OK** is clicked. The change will be discarded and Script Manager closed when **Cancel** is clicked.

2.3 Script Editor

A new script can be created or the script selected in Script Manager can be edited using Script Editor.

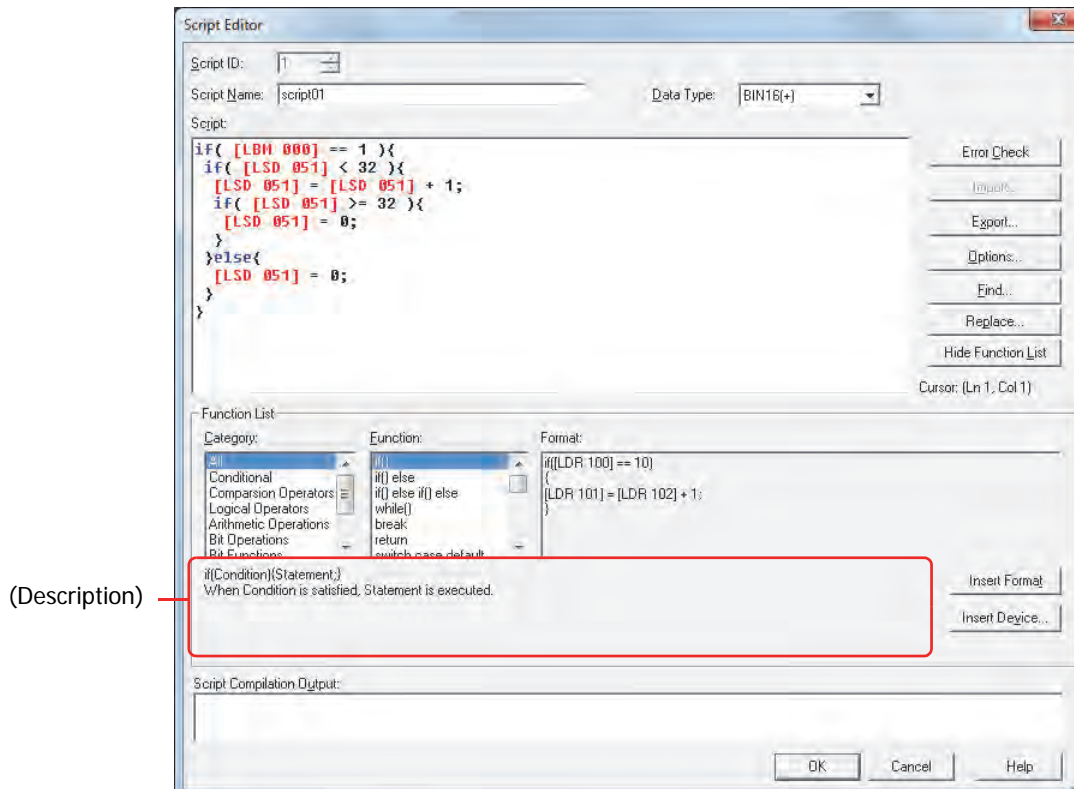

■ Script ID

To create a new script, enter the script ID (1 to 32,000).

To edit an existing script, the set script ID is displayed.

■ Script Name

Enter the script name. The maximum number for script name is 40 characters.

■ Data Type

Select the data type to be processed by the script.

For details about the data type, refer to "1.3 Data Type of the Script" on page 20-3.

■ Script

Enter the script.

Single script limitation is 240 characters per line with up to 1024 lines.

■ Error Check

The script being edited is checked for errors.

■ Import

The Open dialog box is displayed.

By selecting a script saved (exported) in a text format (*.txt) and clicking **Open**, the imported script is inserted at the cursor position of the script being edited.

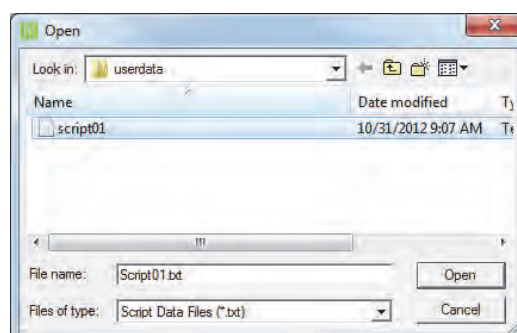

■ Export

The Save As dialog box is displayed.

By selecting a save location and clicking **Save**, the script being edited is saved in text format (*.txt). A saved script can be inserted in the script clicking **Import**.

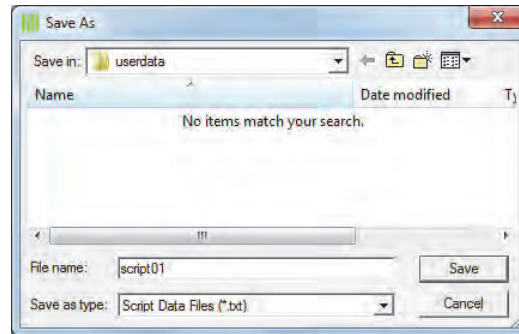

■ Options

The Options dialog box is displayed.

The fonts and color of the text, tab indents, etc., used in the **Script** text box are set in the Options dialog box. For details, refer to “Script Formatting Options dialog box” on page 20-11.

■ Find

The Find dialog box is displayed.

Enter the text to be searched for in the Find What box.

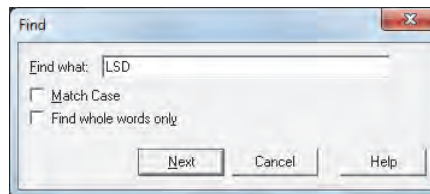

When **Find** is clicked after selecting a range in the **Script** text box, it will only search within the selected range.

■ Replace

The Replace dialog box is displayed.

Text entered in **Find what** will be replaced with the text entered in **Replace with**.

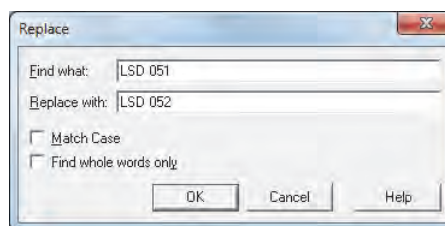

- This is useful when replacing device addresses.
- When **Replace** is clicked after selecting a range in the **Script** text box, it will only search and replace within the selected range.

■ Show/Hide Function List

Switches between showing and not showing the **Function List** and **Script Compilation Output**.



The size of the script edit box can be changed by dragging the right bottom corner of the Script Editor. By hiding the **Function List** and **Script Compilation Output**, the script editing area (text box) will become larger, making the editing of script easier.

■ Cursor

Displays the current position of the cursor in the **Script** text box by line number and column number.

■ Function list

Category:	Lists the categories of the functions.
Function:	Lists the functions of the selected category.
Format:	Displays the definition example of the selected function.
(Description):	Displays the description of the selected function.
Insert Format:	Contents displayed in the selected Format are inserted at the cursor position.
Insert Device:	The Device Address Settings box is displayed. By specifying the device address and clicking on OK , specified device address is inserted at the cursor position.

■ Script Compilation Output

The contents of any errors found when using error check are displayed.

By double-clicking on the comment displayed in the **Script Compilation Output**, the part corresponding to the error is highlighted in the **Script** text box.



Depending on the error, there may be an error in the line that is different from the line displayed in the Script Compilation Output, or multiple errors may be displayed.

■ OK

Error check is performed for the script being edited and save it.



If there is an error in the script being edited, a message will appear before saving the script. It is possible to save a script with an error.

■ Cancel

Closes Script Editor without saving the script being edited.

- Script Formatting Options dialog box

Font, Size, Tab indent, and **Color** used in the **Script** text box of the Script Editor can be specified.

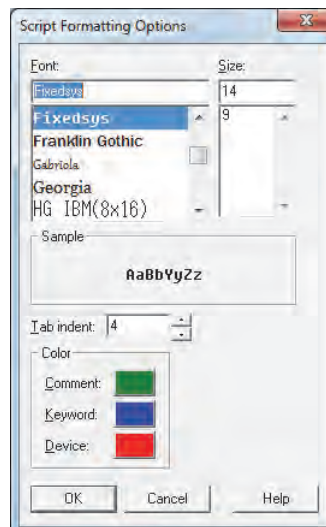

- **Font**

The font name for the text displayed in the **Script** is entered or selected.

- **Size**

The font size (dots) for the text displayed in the **Script** is entered or selected.

- **Sample**

Displays a sample of the text with the **Font** and **Size** as specified in the **Script** text box.

- **Tab indent**

Specify the position of the indent when a tab is inserted (1 to 20).

- **Color**

Displays each of the text colors for **Comment**, **Keyword**, and **Device**.

The Color dialog box is displayed when the color button is clicked.

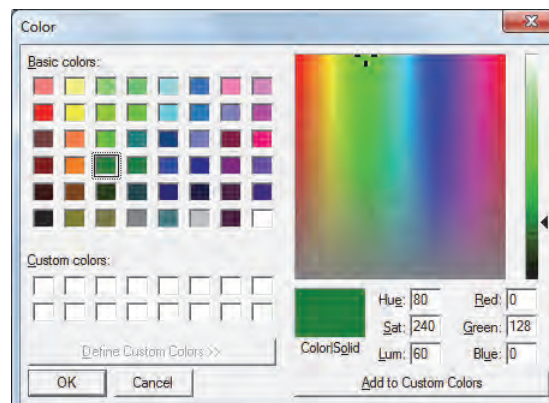

Text other than comment, keyword, or device is displayed in black.

3 Global Script

A Global Script is a script that operates throughout the entire project, regardless of which screen is currently being displayed. Only one Global Script can be set for a project. This script is executed at the end of scan process of Touch in accordance with the trigger condition.

3.1 Setting procedures for Global Script

Global Script is setup using the following procedures.

- 1 On the **Configuration** tab, in the **System Setup** group, click **Global Script**.

The Global Script dialog box is displayed.

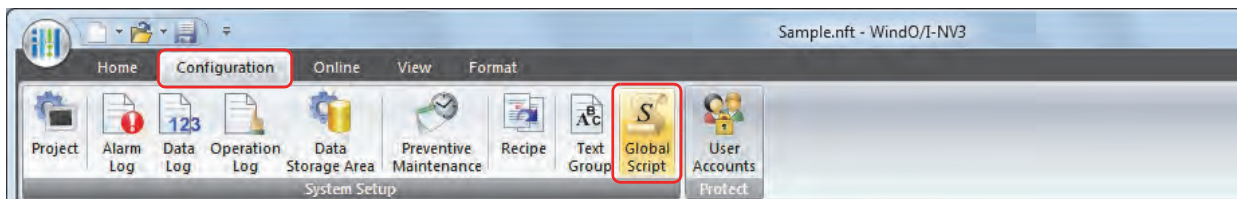

- 2 Click **General** tab and **Trigger Condition** tab.

Set or confirm the items displayed in each of the tabs.

● General Tab

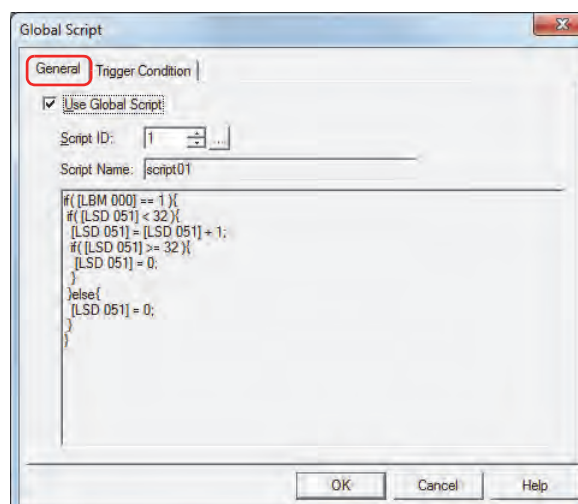

■ Use Global Script

To use the Global Script, select the **Use Global Script** check box.



With Global Script, you cannot do indirect read and indirect write of the external device addresses. (It can be setup in WindO/I-NV3, but it will not operate on the Touch.)

■ Script ID

Specify the script ID (1 to 32,000) of the script to operate.

Script Manager is displayed when is clicked. The script can be selected from the script list of Script Manager. For details, refer to "2.2 Script Manager" on page 20-7.

■ Script Name

Displays the name of the script specified by the script ID.

■ Script

Displays the contents of the script specified by the script ID.

● Trigger Condition Tab

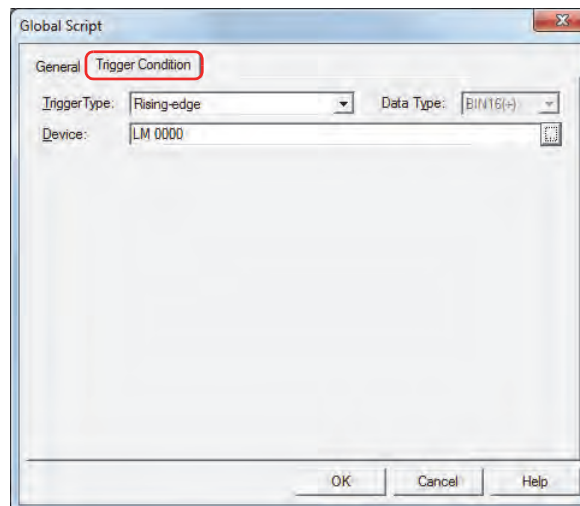

■ Trigger Type

Specify the condition to execute the script.

- Rising-edge: Script is executed when trigger device changes from 0 to 1.
- Falling-edge: Script is executed when trigger device changes from 1 to 0.
- Always ON: Script is executed constantly.
- Fixed Period: Script is executed at set intervals.

■ Device

Specify the bit device or bit of the word device.

This is enabled only when **Rising-edge** or **Falling-edge** is selected in **Trigger Type**.

■ Period (sec)

Specify the scan frequency in seconds (1 to 3,600).

This is enabled only when **Fixed Period** is selected in **Trigger Type**.

4 Script Definition Method

4.1 Format List

This section describes the format and operation of control statements, operators, functions, etc.

Enter everything except comments in single-byte. For specific definition examples, refer to "5 Script Coding Examples" on page 20-22.

● Control statements

Conditional expressions are described as `(Cond. expr.)`, `(Cond. expr. 1)`, `(Cond. expr. 2)` here. Execution lines are described as `(Exe. line)`, `(Exe. line 1)`, `(Exe. line 2)` ...

■ Conditional branching

	Format	Description
if else else if	<code>if ((Cond. expr.) { (Exe. line) ; }</code>	Execution line is executed if the conditional expression is satisfied.
	<code>if ((Cond. expr.) { (Exe. line 1) ; } else { (Exe. line 2) ; }</code>	Execution line 1 is executed if the conditional expression is satisfied. Execution line 2 is executed if it is not satisfied.
	<code>if ((Cond. expr. 1) { (Exe. line 1) ; } else if ((Cond. expr. 2) { (Exe. line 2) ; } else { (Exe. line 3) ; }</code>	Execution line 1 is executed if the conditional expression 1 is satisfied. Conditional expression 2 is determined if conditional expression 1 is not satisfied, and execution line 2 is executed if conditional expression 2 is satisfied. Execution line 3 is executed if conditional expression 2 is not satisfied too.
switch case default	<code>switch ((Cond. expr.) { case constant 1: (Exe. line 1) ; break; case constant2: (Exe. line 2) ; break; default: (Exe. line 3) ; break; }</code>	Execution line 1 is executed if the value of conditional expression matches constant 1. Execution line 2 is executed if the value of conditional expression matches constant 2. Execution line 3 is executed if the value of conditional expression does not match constant 1 nor constant 2. • This can only be used for data types BIN16 (+), BIN16 (+/-), BIN32 (+), BIN32 (+/-), BCD4, and BCD8.

■ Repeat

	Format	Description
while	<code>while ((Cond. expr.) { (Exe. line) ; }</code>	Execution line is repeatedly executed while the conditional expression is satisfied. • It will go into an infinite loop when the conditional expression is always satisfied, so do not set fixed values or devices that do not change as the conditional expression. • Do not write a value to the external device address in the while definition.

■ Halt and exit

	Format	Description
break	<pre>while ((Cond. expr.1) { if ((Cond. expr.2) { (Exe. line 1) ; break; } (Exe. line 2) ; } (Exe. line 3) ;</pre>	<p>Process will be as follows while the conditional expression 1 is satisfied.</p> <ul style="list-style-type: none"> • Execution line 2 is continuously executed while the conditional expression 2 is not satisfied. • Once the conditional expression is satisfied, it will go out of the loop by break (not executing execution line 2), and execution line 3 is executed.
break	<pre>switch ((Cond. expr.) { case constant 1: (Exe. line 1) ; break; case constant 2: (Exe. line 2) ; break; } (Exe. line 3) ;</pre>	<p>When the conditional expression 2 matches the constant 1, it will halt the determination of constant 2 by break after executing execution line 1, and process will move to execution line 3.</p>
return	return;	It will exit the script, and execute the next parts or script.

● Operator

Device, constant, and temporary device are described as , here, and expression is described as , , .

■ Relational operator

Operator	Format	Description
==	<input type="text" value="a"/> == <input type="text" value="b"/>	Compares if <input type="text" value="a"/> is equal to <input type="text" value="b"/> .
!=	<input type="text" value="a"/> != <input type="text" value="b"/>	Compares if <input type="text" value="a"/> is not equal to <input type="text" value="b"/> .
<	<input type="text" value="a"/> < <input type="text" value="b"/>	Compares if <input type="text" value="a"/> is less than <input type="text" value="b"/> .
<=	<input type="text" value="a"/> <= <input type="text" value="b"/>	Compares if <input type="text" value="a"/> is equal or less than <input type="text" value="b"/> .
>	<input type="text" value="a"/> > <input type="text" value="b"/>	Compares if <input type="text" value="a"/> is greater than <input type="text" value="b"/> .
>=	<input type="text" value="a"/> >= <input type="text" value="b"/>	Compares if <input type="text" value="a"/> is equal or greater than <input type="text" value="b"/> .

■ Logical operator

Operator	Format	Description
&&	((Expr.1)) && ((Expr.2))	Calculates the logical product (AND) of <input type="text" value="Expr.1"/> and <input type="text" value="Expr.2"/> .
	((Expr.1)) ((Expr.2))	Calculates the logical sum (OR) of <input type="text" value="Expr.1"/> and <input type="text" value="Expr.2"/> .
!	!((Expr.))	Reverses the logic of <input type="text" value="Expr."/> .

■ Arithmetic operator

Operator	Format	Description
+	<input type="text" value="a"/> + <input type="text" value="b"/>	Adds <input type="text" value="a"/> and <input type="text" value="b"/> .
-	<input type="text" value="a"/> - <input type="text" value="b"/>	Subtracts <input type="text" value="a"/> from <input type="text" value="b"/> .
*	<input type="text" value="a"/> * <input type="text" value="b"/>	Multiplies <input type="text" value="a"/> and <input type="text" value="b"/> .
/	<input type="text" value="a"/> / <input type="text" value="b"/>	Divides <input type="text" value="a"/> by <input type="text" value="b"/> .
%	<input type="text" value="a"/> % <input type="text" value="b"/>	Calculates remainder after dividing <input type="text" value="a"/> by <input type="text" value="b"/> .

■ Bit operator

Operator	Format	Description
&	<input type="text" value="a"/> & <input type="text" value="b"/>	Calculates the logical product (AND) of each bit of <input type="text" value="a"/> and <input type="text" value="b"/> . <ul style="list-style-type: none"> This can only be used for data types BIN16 (+), BIN16 (+/-), BIN32 (+), BIN32 (+/-), BCD4, and BCD8.
	<input type="text" value="a"/> <input type="text" value="b"/>	Calculates the logical sum (OR) of each bit of <input type="text" value="a"/> and <input type="text" value="b"/> . <ul style="list-style-type: none"> This can only be used for data types BIN16 (+), BIN16 (+/-), BIN32 (+), BIN32 (+/-), BCD4, and BCD8.
^	<input type="text" value="a"/> ^ <input type="text" value="b"/>	Calculates the exclusive logical sum (XOR) of each bit of <input type="text" value="a"/> and <input type="text" value="b"/> . <ul style="list-style-type: none"> This can only be used for data types BIN16 (+), BIN16 (+/-), BIN32 (+), BIN32 (+/-), BCD4, and BCD8.
~	~ <input type="text" value="a"/>	Reverses the logic of each bits of <input type="text" value="a"/> . For word device and fixed values, 0 will be 65535, and 65535 will be 0. For bit device, 0 will be 1, and 1 will be 0. <ul style="list-style-type: none"> This can only be used for data types BIN16 (+), BIN16 (+/-), BIN32 (+), BIN32 (+/-), BCD4, and BCD8.
<<	<input type="text" value="a"/> << <input type="text" value="b"/>	Shifts each bit of <input type="text" value="a"/> to left for <input type="text" value="b"/> bit(s). <ul style="list-style-type: none"> This can only be used for data types BIN16 (+), BIN16 (+/-), BIN32 (+), BIN32 (+/-), BCD4, and BCD8.
>>	<input type="text" value="a"/> >> <input type="text" value="b"/>	Shifts each bit of <input type="text" value="a"/> to right for <input type="text" value="b"/> bit(s). <ul style="list-style-type: none"> This can only be used for data types BIN16 (+), BIN16 (+/-), BIN32 (+), BIN32 (+/-), BCD4, and BCD8.

● Function

Device, constant, and temporary device are described as , , , ... here.

■ Bit function

Function	Format	Description
Bit set	SET(<input type="text" value="a"/>);	Turns bit device <input type="text" value="a"/> to 1. It will be same result as <input type="text" value="a"/> = 1;
Bit reset	RST(<input type="text" value="a"/>);	Turns bit device <input type="text" value="a"/> to 0. It will be same result as <input type="text" value="a"/> = 0;
Bit reverse	REV(<input type="text" value="a"/>);	Reverses the 1 and 0 of bit device <input type="text" value="a"/> . It will be same result as <input type="text" value="a"/> = ~ <input type="text" value="a"/> ;

■ Word function

Arithmetic operation

Function	Format	Description
Maximum value	MAX(<input type="text" value="a"/> , <input type="text" value="b"/> , <input type="text" value="c"/>)	Maximum value out of <input type="text" value="a"/> , <input type="text" value="b"/> , <input type="text" value="c"/> is returned. <ul style="list-style-type: none"> This can be used for all data types. Up to 15 arguments can be defined.
Minimum value	MIN(<input type="text" value="a"/> , <input type="text" value="b"/> , <input type="text" value="c"/>)	Minimum value out of <input type="text" value="a"/> , <input type="text" value="b"/> , <input type="text" value="c"/> is returned. <ul style="list-style-type: none"> This can be used for all data types. Up to 15 arguments can be defined.
Exponential function	EXP(<input type="text" value="a"/>)	Exponential function of <input type="text" value="a"/> is returned. <ul style="list-style-type: none"> This can only be used for data type float32.
Natural logarithm (Base: e)	LOGE(<input type="text" value="a"/>)	Natural logarithm (base is e) for <input type="text" value="a"/> is returned. <ul style="list-style-type: none"> This can only be used for data type float32. Set a value larger than 0 for argument.
Common logarithm (Base: 10)	LOG10(<input type="text" value="a"/>)	Common logarithm (base is 10) for <input type="text" value="a"/> is returned. <ul style="list-style-type: none"> This can only be used for data type float32. Set a value larger than 0 for argument.
Exponentiation	POW(<input type="text" value="a"/> , <input type="text" value="b"/>)	<input type="text" value="a"/> to the <input type="text" value="b"/> power is returned. <ul style="list-style-type: none"> This can only be used for data type float32.

(Continued to next page)

Arithmetic operation (Continued)

Function	Format	Description
Square root	ROOT(<input type="text" value="a"/>)	Square root of <input type="text" value="a"/> is returned. • This can only be used for data type float32.
Sine	SIN(<input type="text" value="a"/>)	Sine of <input type="text" value="a"/> (-1 - +1) is returned. Specify arbitrary formula to represent angle (units in radian) for argument <input type="text" value="a"/> . • This can only be used for data type float32.
Cosine	COS(<input type="text" value="a"/>)	Cosine of <input type="text" value="a"/> (-1 - +1) is returned. Specify arbitrary formula to represent angle (units in radian) for argument <input type="text" value="a"/> . • This can only be used for data type float32.
Tangent	TAN(<input type="text" value="a"/>)	Tangent of <input type="text" value="a"/> (-1 - +1) is returned. Specify arbitrary formula to represent angle (units in radian) for argument <input type="text" value="a"/> . • This can only be used for data type float32.
Arcsine	ASIN(<input type="text" value="a"/>)	Arcsine of <input type="text" value="a"/> (-1 - +1) in radian value (- $\pi/2$ - + $\pi/2$) is returned. Specify arbitrary formula for argument <input type="text" value="a"/> . • This can only be used for data type float32.
Arccosine	ACOS(<input type="text" value="a"/>)	Arccosine of <input type="text" value="a"/> (-1 - +1) in radian value (0 - π) is returned. Specify arbitrary formula for argument <input type="text" value="a"/> . • This can only be used for data type float32.
Arctangent	ATAN(<input type="text" value="a"/>);	Arctangent of <input type="text" value="a"/> (-1 - +1) in radian value (- $\pi/2$ - + $\pi/2$) is returned. Specify arbitrary formula for argument <input type="text" value="a"/> . • This can only be used for data type float32.
Conversion from Angle to Radian	RAD(<input type="text" value="a"/>);	Value of <input type="text" value="a"/> is converted from degree (°) to radian, and the value is returned. • This can only be used for data type float32.
Conversion from Radian to Angle	DEG(<input type="text" value="a"/>);	Value of <input type="text" value="a"/> is converted from radian to degree (°), and the value is returned. • This can only be used for data type float32.

Data type conversion

Function	Format	Description
Conversion from BCD to Binary	BCD2BIN(<input type="text" value="a"/>)	BCD value of <input type="text" value="a"/> is returned in binary value. • This can be used with data types BIN16 (+), BIN16 (+/-), BIN32 (+), and BIN32 (+/-).
Conversion from Binary to BCD	BIN2BCD(<input type="text" value="a"/>)	Binary value of <input type="text" value="a"/> is returned in BCD value. • This can be used with data types BIN16 (+), BIN16 (+/-), BIN32 (+), and BIN32 (+/-).
Conversion from float32 to Binary	FLOAT2BIN(<input type="text" value="a"/>)	Float32 value of <input type="text" value="a"/> is returned in binary value. Values under the decimal point is truncated. • This can be used with data types BIN32 (+) and BIN32 (+/-).
Conversion from Binary to float32	BIN2FLOAT(<input type="text" value="a"/>)	Binary value of <input type="text" value="a"/> is returned in float32 value. • This can be used with data types BIN32 (+) and BIN32 (+/-).
Conversion from Decimal to String character	DEC2ASCII(<input type="text" value="a"/> , <input type="text" value="b"/>)	Decimal number value <input type="text" value="b"/> is converted to a character string, and store in order with <input type="text" value="a"/> as a starting device. • This can be used with data types BIN16 (+), BIN16 (+/-), BIN32 (+), BIN32 (+/-), BCD4, and BCD8.
Conversion from String character to Decimal	ASCII2DEC(<input type="text" value="a"/>)	Character string <input type="text" value="a"/> is returned as decimal number value. • This can be used with data types BIN16 (+), BIN16 (+/-), BIN32 (+), BIN32 (+/-), BCD4, and BCD8.

Data comparison and copy

Function	Format	Description
Data comparison	MEMCMP ([a] , [b] , [c])	<p>[a] : Starting device of comparison target 1 [b] : Starting device of comparison target 2 [c] : Range of comparison (in words)</p> <p>Values of device [a] for [c] words and values of device [b] for [c] words are compared. 1 is returned if all the values of devices match, and 0 is returned if any of the value does not match.</p> <ul style="list-style-type: none"> Specified range is compared in word unit, and result is returned. Up to 64 words can be compared.
Data copy	MEMCPY ([a] , [b] , [c])	<p>[a] : Starting device of copy source [b] : Starting device of copy target [c] : Range of copy (in words)</p> <p>Values from [a] for [c] words are copied to [b] for [c] words respectively.</p> <ul style="list-style-type: none"> Specified range is copied in word unit. Up to 64 words can be copied.
Bit device (1 word length) to Bit device (1 word length)	BITS2BITS ([a] , [b]) ;	<p>[a] : Starting device of copy target (bit device) [b] : Starting device of copy source (bit device)</p> <p>Copies one word worth of data from [b] to [a].</p> <ul style="list-style-type: none"> 16 bits are processed from the starting bit device as one word. This can only be used in control functions.
Bit device (1 word length) to Word device	BITS2WORD ([a] , [b]) ;	<p>[a] : Starting device of copy target (bit device) [b] : Starting device of copy source (word device)</p> <p>Copies one word worth of data from [b] to [a].</p> <ul style="list-style-type: none"> 16 bits are processed from the starting bit device as one word. This can only be used in control functions.
Word device to Bit device (1 word length)	WORD2BITS ([a] , [b]) ;	<p>[a] : Starting device of copy target (word device) [b] : Starting device of copy source (bit device)</p> <p>Copies one word worth of data from [b] to [a].</p> <ul style="list-style-type: none"> 16 bits are processed from the starting bit device as one word. This can only be used in control functions.

Character string operation *1

Only internal devices can be specified as an argument for character string operation function. Termination character NULL (0x00) is treated as end of character string when character string is handled. Also, termination character NULL is not included in the length of the character string.

Function	Format	Description
Character string copy	STRCUT ([a] , [b] , [c] , [d])	<p>[a] : Starting device of copy target [b] : Starting device containing copy source character string [c] : Start location of copy (0-127) [d] : Number of characters to copy (1-128)</p> <p>From the character string starting from [b], character string from [c] bytes forward for [d] characters are stored into [a] for [d] characters.</p>
Character number count	STRLEN ([a])	Number of characters for character string starting from [a] is returned.
Character string concatenation	STRCAT ([a] , [b])	To the character string starting from [a], the character string starting from [b] is concatenated, and [a] is returned to beginning.
Character string search	STRSTR ([a] , [b])	From the character string starting from [a], character string starting from [b] is searched, and location found (number of characters from beginning -1) is returned. The maximum number for character string to search is 128 characters.

*1 HMI function only

Draw*1

This is a function to draw an object on the screen. Top left corner of the screen is coordinates X=0 and Y=0. When a device is used as an argument, an object is drawn with the changed value when the value is changed. However, the object that is already drawn is not erased. To erase the drawn object, overwrite it with the background color. When an out-of-range value is used as an argument, 5 is stored in the LSD53 and script is halted.

Function	Format	Description																																																												
Drawing of straight line	LINE([a] , [b] , [c] , [d] , [e] , [f] , [g])	Straight line connecting the start coordinate and end coordinate is drawn. [a] : Start coordinate X, [b] : Start coordinate Y, [c] : End coordinate X, [d] : End coordinate Y, [e] : Line width, [f] : Line type, [g] : Line color • [e] : Line width, [f] : Line type, [g] : Line color can be omitted. • Specification of [e] : Line width is as follows: <table border="1"> <tr> <th>Set value</th> <td>1</td> <td>2</td> <td>3</td> <td>5</td> </tr> <tr> <th>Line width</th> <td>1 dot</td> <td>2 dots</td> <td>3 dots</td> <td>5 dots</td> </tr> </table> It will be set to 1 (1 dot) when omitted. • Specification of [f] : Line type is as follows. <table border="1"> <tr> <th>Set value</th> <td>1</td> <td>2</td> <td>3</td> <td>4</td> <td>5</td> <td>6</td> </tr> <tr> <th>Line type</th> <td>Solid</td> <td>Dot</td> <td>Dash</td> <td>Long Dash</td> <td>Long Dash Dot</td> <td>Long Dash Dot Dot</td> </tr> </table> It will be set to 1 (Solid) when omitted or when the line width is set to anything other than 1 (1 dot). • [g] : Line color is specified by the color data. It will be set to 255 (white) when omitted. For color data, refer to Appendix "1 Color Number Correspondence Table" on page A-1.	Set value	1	2	3	5	Line width	1 dot	2 dots	3 dots	5 dots	Set value	1	2	3	4	5	6	Line type	Solid	Dot	Dash	Long Dash	Long Dash Dot	Long Dash Dot Dot																																				
	Set value	1	2	3	5																																																									
Line width	1 dot	2 dots	3 dots	5 dots																																																										
Set value	1	2	3	4	5	6																																																								
Line type	Solid	Dot	Dash	Long Dash	Long Dash Dot	Long Dash Dot Dot																																																								
	LINE([a] , [b] , [c] , [d])	Rectangle with left top corner as start coordinate and bottom right corner as end coordinate is drawn. [a] : Start coordinate X, [b] : Start coordinate Y, [c] : End coordinate X, [d] : End coordinate Y, [e] : Line width, [f] : Line type, [g] : Foreground color, [h] : Background color, [i] : Pattern, [j] : Rounded corner type, [k] : Rounded corner radius • [e] : Line width, [f] : Line type, [g] : Foreground color, [h] : Background color, [i] : Pattern, [j] : Rounded corner type, [k] : Rounded corner radius can be omitted. • Specification of [e] : Line width is as follows: <table border="1"> <tr> <th>Set value</th> <td>1</td> <td>2</td> <td>3</td> <td>5</td> </tr> <tr> <th>Line width</th> <td>1 dot</td> <td>2 dots</td> <td>3 dots</td> <td>5 dots</td> </tr> </table> It will be set to 1 (1 dot) when omitted. • Specification of [f] : Line type is as follows. <table border="1"> <tr> <th>Set value</th> <td>1</td> <td>2</td> <td>3</td> <td>4</td> <td>5</td> <td>6</td> </tr> <tr> <th>Line type</th> <td>Solid</td> <td>Dot</td> <td>Dash</td> <td>Long Dash</td> <td>Long Dash Dot</td> <td>Long Dash Dot Dot</td> </tr> </table> It will be set to 1 (Solid) when omitted or when the line width is set to anything other than 1 (1 dot). • [g] : Foreground color, [h] : Background color is specified by the color data. It will be set to 255 (white) when omitted. For color data, refer to Appendix "1 Color Number Correspondence Table" on page A-1. • Specification of [i] : Pattern is as follows. <table border="1"> <tr> <th>Set value</th> <td>0</td> <td>2</td> <td>3</td> <td>4</td> <td>7</td> <td>8</td> </tr> <tr> <th>Line type</th> <td>None</td> <td>Foreground 100%</td> <td>Foreground 25%</td> <td>Foreground 50%</td> <td>Background 100%</td> <td>Horizontal lines</td> </tr> <tr> <th>Set value</th> <td>9</td> <td>10</td> <td>11</td> <td>12</td> <td>13</td> <td></td> </tr> <tr> <th>Line type</th> <td>Vertical lines</td> <td>Slant Upwards</td> <td>Slant Down-wards</td> <td>Cross-hatch</td> <td>Tint</td> <td></td> </tr> </table> It will be set to 0 (None) when omitted. • Specification of [j] : Rounded corner type is as follows. <table border="1"> <tr> <th>Set value</th> <td>0</td> <td>1</td> <td>2</td> </tr> <tr> <th>Line type</th> <td>None</td> <td>Straight</td> <td>Curve</td> </tr> </table> It will be set to 0 (None) when omitted. • [k] : Rounded corner radius is specified with number of dots (0 - 200). It will be set to 0 (0 dot) when omitted.	Set value	1	2	3	5	Line width	1 dot	2 dots	3 dots	5 dots	Set value	1	2	3	4	5	6	Line type	Solid	Dot	Dash	Long Dash	Long Dash Dot	Long Dash Dot Dot	Set value	0	2	3	4	7	8	Line type	None	Foreground 100%	Foreground 25%	Foreground 50%	Background 100%	Horizontal lines	Set value	9	10	11	12	13		Line type	Vertical lines	Slant Upwards	Slant Down-wards	Cross-hatch	Tint		Set value	0	1	2	Line type	None	Straight	Curve
Set value	1	2	3	5																																																										
Line width	1 dot	2 dots	3 dots	5 dots																																																										
Set value	1	2	3	4	5	6																																																								
Line type	Solid	Dot	Dash	Long Dash	Long Dash Dot	Long Dash Dot Dot																																																								
Set value	0	2	3	4	7	8																																																								
Line type	None	Foreground 100%	Foreground 25%	Foreground 50%	Background 100%	Horizontal lines																																																								
Set value	9	10	11	12	13																																																									
Line type	Vertical lines	Slant Upwards	Slant Down-wards	Cross-hatch	Tint																																																									
Set value	0	1	2																																																											
Line type	None	Straight	Curve																																																											
Drawing of Rectangle	RECTANGLE([a] , [b] , [c] , [d] , [e] , [f] , [g] , [h] , [i] , [j] , [k])																																																													
	RECTANGLE([a] , [b] , [c] , [d])																																																													

(Continued to next page)

*1 HMI function only

Draw (Continued)

Function	Format	Description																																																		
Drawing of circle and ellipse	CIRCLE(<input type="text" value="a"/> , <input type="text" value="b"/> , <input type="text" value="c"/> , <input type="text" value="d"/> , <input type="text" value="e"/> , <input type="text" value="f"/> , <input type="text" value="g"/> , <input type="text" value="h"/> , <input type="text" value="i"/>)	<p>A circle with specified radius from center coordinate is drawn.</p> <p><input type="text" value="a"/> : Center coordinate X, <input type="text" value="b"/> : Center coordinate Y, <input type="text" value="c"/> : X axis radius, <input type="text" value="d"/> : Y axis radius, <input type="text" value="e"/> : Line width, <input type="text" value="f"/> : Line type, <input type="text" value="g"/> : Foreground color, <input type="text" value="h"/> : Background color, <input type="text" value="i"/> : Pattern</p> <ul style="list-style-type: none"> <input type="text" value="e"/> : Line width, <input type="text" value="f"/> : Line type, <input type="text" value="g"/> : Foreground color, <input type="text" value="h"/> : Background color, <input type="text" value="i"/> : Pattern can be omitted. Specification of <input type="text" value="e"/> : Line width is as follows: <table border="1"> <thead> <tr> <th>Set value</th> <th>1</th> <th>2</th> <th>3</th> <th>5</th> </tr> </thead> <tbody> <tr> <td>Line width</td> <td>1 dot</td> <td>2 dots</td> <td>3 dots</td> <td>5 dots</td> </tr> </tbody> </table> <p>It will be set to 1 (1 dot) when omitted.</p> <ul style="list-style-type: none"> Specification of <input type="text" value="f"/> : Line type is as follows. <table border="1"> <thead> <tr> <th>Set value</th> <th>1</th> <th>2</th> <th>3</th> <th>4</th> <th>5</th> <th>6</th> </tr> </thead> <tbody> <tr> <td>Line type</td> <td>Solid</td> <td>Dot</td> <td>Dash</td> <td>Long Dash</td> <td>Long Dash Dot</td> <td>Long Dash Dot Dot</td> </tr> </tbody> </table> <p>It will be set to 1 (Solid) when omitted or when the line width is set to anything other than 1 (1 dot).</p> <ul style="list-style-type: none"> <input type="text" value="g"/> : Foreground color, <input type="text" value="h"/> : Background color is specified by the color data. It will be set to 255 (white) when omitted. For color data, refer to Appendix "1 Color Number Correspondence Table" on page A-1. Specification of <input type="text" value="i"/> : Pattern is as follows. <table border="1"> <thead> <tr> <th>Set value</th> <th>0</th> <th>2</th> <th>3</th> <th>4</th> <th>7</th> <th>8</th> </tr> </thead> <tbody> <tr> <td>Line type</td> <td>None</td> <td>Foreground 100%</td> <td>Foreground 25%</td> <td>Foreground 50%</td> <td>Background 100%</td> <td>Horizontal lines</td> </tr> </tbody> </table> <table border="1"> <thead> <tr> <th>Set value</th> <th>9</th> <th>10</th> <th>11</th> <th>12</th> <th>13</th> </tr> </thead> <tbody> <tr> <td>Line type</td> <td>Vertical lines</td> <td>Slant Upwards</td> <td>Slant Down-wards</td> <td>Cross-hatch</td> <td>Tint</td> </tr> </tbody> </table> <p>It will be set to 0 (none) when omitted.</p>	Set value	1	2	3	5	Line width	1 dot	2 dots	3 dots	5 dots	Set value	1	2	3	4	5	6	Line type	Solid	Dot	Dash	Long Dash	Long Dash Dot	Long Dash Dot Dot	Set value	0	2	3	4	7	8	Line type	None	Foreground 100%	Foreground 25%	Foreground 50%	Background 100%	Horizontal lines	Set value	9	10	11	12	13	Line type	Vertical lines	Slant Upwards	Slant Down-wards	Cross-hatch	Tint
	Set value	1	2	3	5																																															
Line width	1 dot	2 dots	3 dots	5 dots																																																
Set value	1	2	3	4	5	6																																														
Line type	Solid	Dot	Dash	Long Dash	Long Dash Dot	Long Dash Dot Dot																																														
Set value	0	2	3	4	7	8																																														
Line type	None	Foreground 100%	Foreground 25%	Foreground 50%	Background 100%	Horizontal lines																																														
Set value	9	10	11	12	13																																															
Line type	Vertical lines	Slant Upwards	Slant Down-wards	Cross-hatch	Tint																																															
	CIRCLE(<input type="text" value="a"/> , <input type="text" value="b"/> , <input type="text" value="c"/> , <input type="text" value="d"/>)																																																			

Offset

Function	Format	Description
Indirect specification	OFFSET(<input type="text" value="a"/> , <input type="text" value="b"/>)	<p><input type="text" value="a"/> : Reference device <input type="text" value="b"/> : Device to store the indirect value (0 to 32767)</p> <p>Specify the device <input type="text" value="b"/> words from <input type="text" value="a"/>.</p> <p>Indirect read Specify OFFSET function to the right of the assignment statement.</p> <p>Format example: <input type="text" value="c"/> = OFFSET(<input type="text" value="a"/> , <input type="text" value="b"/>)</p> <p>Operation: Stores the value of device in <input type="text" value="b"/> words from <input type="text" value="a"/> into <input type="text" value="c"/>.</p> <p>Indirect write Specify OFFSET function to the left of the assignment statement.</p> <p>Format example: OFFSET(<input type="text" value="a"/> , <input type="text" value="b"/>) = <input type="text" value="c"/></p> <p>Operation: Stores the value of <input type="text" value="c"/> into the device <input type="text" value="b"/> words from <input type="text" value="a"/>.</p> <ul style="list-style-type: none"> Store the value appropriate for the data type as the indirect value. As an example, when the data type is BCD4, store the indirect value of BCD4 into the device.

● Other

This section provides definitions for constant, device, temporary device, and comment.

■ Constant

Constant can be defined as decimal or hexadecimal numbers.

Sample definition of decimal numbers

1234	Define the numeric value directly.
-1234	Define the negative number with a "-" (minus) symbol at the beginning.
12.34	Decimal number can be defined for real numbers (float32). Define a "." (period) between the whole numbers and decimal numbers.

There are 2 ways to define hexadecimal numbers.

Sample definition of hexadecimal numbers

0x12AB	Define "0" (zero) and "x" (lower case x) at the beginning of the value.
12ABh	Append "h" at the tail of the value.

■ Device Address

Device Address is defined with the device symbol and address within "[" and "]".

Definition of the device

[Device symbol address]	(" " represents a space.)
-------------------------	---------------------------

Sample definition

[LDR 100]

■ Temporary Device

Temporary device is a device that can be used only with the script. It can store a value and can be used as a variable. It is defined with a device symbol "@" followed by address (HMI function: 1 to 16, Control function: 1 to 32).

Definition of the temporary device

@Address	(Space between the device symbol "@" and address is not required.)
----------	--

Sample definition

@2	Temporary device number 2
----	---------------------------



All the values for temporary devices are set to "0" when the execution of the script is started.

■ Comment

A note defined in the script is called a comment. The line with "//" defined at the beginning of a line will become a comment. "//" is defined with a single-byte. Double-byte characters can be used after "//".

Definition of comment

// Arbitrary note

Sample definition

// Store the initial value to calculation data [LDR 100] for process A [LDR 100] = 1234; : :	←This line is not executed.
--	-----------------------------



- It will be useful to use comments to explain the contents of the script (especially when the editor of the script has changed or some time has passed since editing).
- Comments are ignored (not executed) when the script is executed, so they can be defined freely without worrying about the execution time.

5 Script Coding Examples

This section provides script coding examples for control statements, arithmetic operators, and functions, as well as the descriptions of their operations. However, the devices that can be used and their notation varies based on HMI functions and control functions. Please program a script with the devices and notation that can be used for each respective function.

5.1 Control Statements

■ Example 5.1.1 Conditional branch

Script

```
if ([LDR 100])
{
    [LDR 200] = 100;
}
```

Operation description

If the value of LDR100 is not 0, then 100 is stored in LDR200.

■ Example 5.1.2 Conditional branching

Script

```
if ([LM 100])
{
    [LDR 200] = [LDR 300] + [LDR 400] + [LDR 500];
}
```

Operation description

If the value of LM100 is not 0, then LDR300, LDR400, and LDR500 are added and that value is stored in LDR200.

■ Example 5.1.3 Conditional branching

Script

```
if (0 != [LDR 100])
{
    if (0 != [LDR 200])
    {
        [LDR 300] = 0x1234;
    }
}
```

Operation description

If the value of LDR100 is not 0 and the value of LDR200 is also not 0, then 0x1234 is stored in LDR300.

If the value of LDR100 is not 0 and the value of LDR200 is 0, then nothing is executed.

If the value of LDR100 is 0, then nothing is executed regardless of the value of LDR200.

■ Example 5.1.4 Conditional branching

Script

```
if ((0 != [LDR 100]) || (0 != [LDR 200]))
{
    [LDR 300] = 100;
}
else
{
    [LDR 400] = [LDR 500] + 100;
}
```

Operation description

If either the value of LDR100 or the value of LDR200 is not 0, then 100 is stored in LDR300.

If the value of both LDR100 and LDR200 is 0, 100 is added to LDR500 and that value is stored in LDR400.

■ Example 5.1.5 Conditional branching

Script

```
if ([LDR 100] == 0)
{
    [LDR 200] = 0x1234;
}
else if ([LDR 100] == 1)
{
    [LDR 200] = 0x5678;
}
else
{
    [LDR 200] = 0x9999;
}
```

Operation description

If the value of LDR100 is 0, then 0x1234 is stored in LDR200.

If the value of LDR100 is 1, then 0x5678 is stored in LDR200.

If the value of LDR100 is not 0 or 1, then 0x9999 is stored in LDR200.

■ Example 5.1.6 Conditional branching

Script

```
if ([LDR 100])
{
    if ([LDR 200])
    {
        if ([LDR300])
        {
            [LDR 400] = 100;
        }
        else
        {
            [LDR 400] = 200;
        }
    }
}
```

Operation description

If the values of LDR100, LDR200, and LDR300 are all not 0, then 100 is stored in LDR400.

If the values of LDR100 and LDR200 are not 0 and the value of LDR300 is 0, then 200 is stored in LDR400.

If either the value of LDR100 or LDR200 is 0, then nothing is executed regardless of the value of LDR300.

■ Example 5.1.7 Iteration**Script**

```
[LDR 100] = 10;  
[LDR 200] = 10;  
  
while (0 < [LDR 100])  
{  
    [LDR 200] = [LDR 200] + 1;  
    [LDR 100] = [LDR 100] - 1;  
}
```

Operation description

If the value of LDR100 is larger than 0, then 1 is repeatedly added to the value of LDR200 and 1 is repeatedly subtracted from the value of LDR100.

In the script example above, when the while statement repeats ten times, the value of LDR100 becomes 0 and the while statement ends.

After this script executes, the value of LDR100 is 0 and the value of LDR200 is 20.

■ Example 5.1.8 Iteration**Script**

```
[LDR 100] = 0;  
[LDR 200] = 3;  
[LDR 300] = 5;  
  
while ([LDR 100] == 0)  
{  
    [LDR 200] = [LDR 200] + 1;  
  
    if ([LDR 300] = [LDR 200])  
    {  
        SET([LM 0]);  
        break;  
    }  
}
```

Operation description

While the value of LDR100 is 0, the while statement repeats.

Inside the while statement, if the values of LDR200 and LDR300 are equal, the while statement will terminate, and after [LM 0] changes to 1, execution breaks out of the while statement.

In the script example above, the values of LDR200 and LDR300 are equal when the while statement repeats twice, and after LM0 changes to 1, execution breaks out of the while statement loop. After execution, the value of LDR100 is 0, the value of LDR200 is 5, the value of LDR300 is 5, and LM0 is 1.

■ Example 5.1.9 Indirect write and indirect read using iteration (while statement)

Script

```
// Transfer LDR10 through LDR19 to LDR100 through LDR109

// Initialize the indirect value
[LDR 0] = 0;

// Loop ten times
while ([LDR 0] < 10)
{
    // Transfer 1 word by indirect assignment
    OFFSET([LDR 100], [LDR 0]) = OFFSET([LDR 10], [LDR 0]);
    // Increment indirect value
    [LDR 0] = [LDR 0] + 1
}
```

This script stores the values of LDR10 through LDR19 in LDR100 through LDR109.

It operates as follows.

First, the indirect value LDR0 is initialized and set to 0.

First iteration (loop): The value of LDR0 is 0, so the condition "[LDR 0] < 10" is true and the statements inside while are executed.

- The value of LDR10, 0 words from LDR10, is stored in LDR100, 0 words from LDR100.
- 1 is added to the value of the indirect value LDR0 so that it becomes 1.

Second iteration (loop): The value of LDR0 is 1, so the condition "[LDR 0] < 10" is true and the statements inside while are executed.

- The value of LDR11, 1 word from LDR10, is stored in LDR101, 1 word from LDR100.
- 1 is added to the value of the indirect value LDR0 so that it becomes 2.

:

(Repeats in this manner for the third to ninth iterations)

:

Tenth iteration (loop): The value of LDR0 is 9, so the condition "[LDR 0] < 10" is true and the statements inside while are executed.

- The value of LDR19, 9 words from LDR10, is stored in LDR109, 9 words from LDR100.
- 1 is added to the value of the indirect value LDR0 so that it becomes 10.

The value of LDR0 is 10, so the condition "[LDR 0] < 10" is false and execution breaks out of the while loop.

After execution, the values of LDR100 through LDR109 are the values of LDR10 through LDR19.

■ Example 5.1.10 Decimal to octal conversion using a while statement**Script**

```
// Convert a decimal value to octal
// - For example, convert 10 (dec) to 12 (oct), 16 (dec) to 20 (oct)
// - Convert a value to octal up to 4 digits max

@1 = 0;           // while counter
@2 = [LDR 100];  // gets original data
@3 = 1;          // decimal base
@4 = 0;          // calculation results

// repeat four times
while (@1 < 4)
{
    // Extract 1st octal digit from original data. Store working result in @10.
    @10 = @2 % 8;
    // Convert the extracted results to decimal and add to results
    @4 = @4 + (@10 * @3);

    // Increase the decimal base by one digit
    @3 = @3 * 10;
    // Reduce the original data by one digit
    @2 = @2 / 8;
    // If @2 is 0, terminate the while statement
    if (0 == @2)
    {
        break;
    }

    // Increment while counter by 1
    @1 = @1 + 1;
}

// Store the calculation result in LDR200
[LDR 200] = @4;
```

Operation description

This example converts a decimal value to octal using a while statement.

By repeating the process to divide the original decimal data by 8 and converting each digit to octal in a while statement, the conversion is implemented up to four digits.

The unconverted decimal value is stored in LDR100. After the script is executed, the converted octal value is stored in LDR200.

■ **Example 5.1.11** Conditional branching with switch

Script

```
switch ([LDR 100])
{
  case 10:
    [LDR 200] = 0x1234;
    break;
  case 999:
    [LDR 200] = 0x5678;
    SET([LM 10]);
    break;
}
```

Operation description

If the value of LDR100 is 10, then 0x1234 is stored in LDR200.

If the value of LDR100 is 999, then 0x5678 is stored in LDR200 and LM10 turns on.

If the value of LDR100 is not 10 or 999, then nothing is executed.

■ **Example 5.1.12** Conditional branching with switch using the default statement

Script

```
switch ([LDR 100])
{
  case 0:
    [LDR 200] = 0x1234;
    break;
  case 1:
    [LDR 200] = 0x5678;
    break;
  default:
    [LDR 200] = 0x9999;
    break;
}
```

Operation description

If the value of LDR100 is 0, then 0x1234 is stored in LDR200.

If the value of LDR100 is 1, then 0x5678 is stored in LDR200.

If the value of LDR100 is not 0 or 1, then 0x9999 is stored in LDR200.

■ **Example 5.1.13** Terminate the script with the return statement

Script

```
if (0x1234 == [LDR 100])
{
  [LDR 200] = 0x5678;
  return;
}
[LDR 300] = 0;
```

Operation description

If the value of LDR100 is not 0x1234, then 0 is stored in LDR300.

If the value of LDR100 is 0x1234, then 0x5678 is stored in LDR200 and the script terminates.

The return statement does not break out of a function like the break statement, it terminates the script and executes the next part or script.

- **Example 5.1.14** Break out of a loop with the break statement

Script

```
[LDR 100] = 0;
[LDR 200] = 3;
[LDR 300] = 5;

while ([LDR 100] == 0)
{
    [LDR 200] = [LDR 200] + 1;

    if ([LDR 200] == [LDR 300])
    {
        SET([LM 0]);
        break;
    }
}
```

Operation description

While the value of LDR100 is 0, the while statement repeats until LDR200 and LDR300 are equal.

Inside the while statement, if the values of LDR200 and LDR300 are equal, the while statement will end and execution breaks out of the while statement.

In the script example above, the values of LDR200 and LDR300 are equal when the while statement repeats twice, and after LM0 changes to 1, the while statement ends. After execution, the value of LDR100 is 0, the value of LDR200 is 5, the value of LDR300 is 5, and the value of LM0 is 1.

5.2 Relational Operators

- **Example 5.2.1** Equal to

Script

```
if ([LDR 100] == [LDR 200])
{
    [LDR 300] = 0x100;
}
```

Operation description

If the value of LDR100 is equal to the value of LDR200, then 0x100 is stored in LDR300.

- **Example 5.2.2** Not equal to

Script

```
if ([LDR 100] != [LDR 200])
{
    [LDR 300] = 0x100;
}
```

Operation description

If the value of LDR100 is not equal to the value of LDR200, then 0x100 is stored in LDR300.

- **Example 5.2.3** Less than

Script

```
if ([LDR 100] < [LDR 200])
{
    [LDR 300] = 0x100;
}
```

Operation description

If the value of LDR100 is less than the value of LDR200, then 0x100 is stored in LDR300.

■ Example 5.2.4 Less than or equal to**Script**

```
if ([LDR 100] <= [LDR 200])
{
    [LDR 300] = 0x100;
}
```

Operation description

If the value of LDR100 is less than or equal to the value of LDR200, then 0x100 is stored in LDR300.

■ Example 5.2.5 Greater than**Script**

```
if ([LDR 100] > [LDR 200])
{
    [LDR 300] = 0x100;
}
```

Operation description

If the value of LDR100 is greater than the value of LDR200, then 0x100 is stored in LDR300.

■ Example 5.2.6 Greater than or equal to**Script**

```
if ([LDR 100] >= [LDR 200])
{
    [LDR 300] = 0x100;
}
```

Operation description

If the value of LDR100 is greater than or equal to the value of LDR200, then 0x100 is stored in LDR300.

5.3 Logical Operators

■ Example 5.3.1 Logical AND

Script

```
if (([LDR 100] == [LDR 200]) && ([LDR 300] == [LDR 400] + [LDR 500]))
{
    [LDR 600] = 100;
}
```

Operation description

If the value of LDR100 is equal to the value of LDR200, and if the value of LDR300 is equal to the value of LDR400 and LDR500 added together, then 100 is stored in LDR600.

If either ([LDR 100] == [LDR 200]) or ([LDR 300] == [LDR 400] + [LDR 500]) is false, the processing in the brackets "{ }" is not executed.

■ Example 5.3.2 Logical OR

Script

```
if ((0 != [LDR 100]) || (0 != [LDR 200]))
{
    [LDR 300] = 100;
}
```

Operation description

If the value of LDR100 is not 0 or the value of LDR200 is not 0, then 100 is stored in LDR300.

If either is true, the processing in the brackets "{ }" is executed.

■ Example 5.3.3 Logical inversion

Script

```
if (!( [LDR 100] == 0x1234 ))
{
    [LDR 300] = 100;
}
```

Operation description

If the value of LDR100 is not equal to 0x1234, then 100 is stored in LDR300.

■ Example 5.3.4 Logical inversion

Script

```
if (!(0 != [LDR 100]))
{
    [LDR 300] = 100 ;
}
```

Operation description

If the value of LDR100 is 0, then 100 is stored in LDR300.

This is the same as the code "if (0==[LDR 100])".

5.4 Arithmetic Operators

■ Example 5.4.1 Addition

Script

```
[LDR 300] = [LDR 100] + [LDR 200];
```

Operation description

The values of LDR100 and LDR200 are added together and the result is stored in LDR300.

■ Example 5.4.2 Subtraction

Script

```
[LDR 300] = [LDR 100] - [LDR 200];
```

Operation description

The value of LDR200 is subtracted from the value of LDR100 and the result is stored in LDR300.

■ Example 5.4.3 Multiplication

Script

```
[LDR 300] = [LDR 100] * [LDR 200];
```

Operation description

The values of LDR100 and LDR200 are multiplied together and the result is stored in LDR300.

■ Example 5.4.4 Division

Script

```
[LDR 300] = [LDR 100] / [LDR 200];
```

Operation description

The value of LDR100 is divided into the value of LDR200 and the result is stored in LDR300.

■ Example 5.4.5 Modulo

Script

```
[LDR 300] = [LDR 100] % [LDR 200];
```

Operation description

The value of LDR100 is divided into the value of LDR200 and the remainder is stored in LDR300.

5.5 Bitwise Operators

■ Example 5.5.1 Logical AND

Script

```
if ([LM 100] & [LM 101])
{
    SET([LM 200]);
}
else
{
    RST([LM 200]);
}
```

Operation description

If the bitwise logical AND operation on the values of LM100 and LM101 is 1, LM200 changes to 1. If the bitwise logical AND operation on the values of LM100 and LM101 is 0, LM200 changes to 0. The operation is the same as the following ladder diagram.

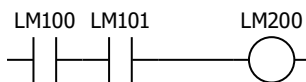

■ Example 5.5.2 Logical OR

Script

```
if ([LM 100] | [LM 101])
{
    SET([LM 200]);
}
else
{
    RST([LM 200]);
}
```

Operation description

If the bitwise logical OR operation on the values of LM100 and LM101 is 1, LM200 changes to 1. If the bitwise logical OR operation on the values of LM100 and LM101 is 0, LM200 changes to 0. The operation is the same as the following ladder diagram.

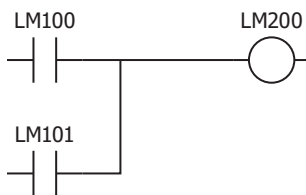

■ Example 5.5.3 Logical XOR (exclusive OR)

Script

```
[LDR 200] = [LDR 100] ^ 0xFF;
```

Operation description

The logical XOR operation on the value of LDR100 and each bit in 0xFF is stored in LDR200. For example, if the value of LDR100 is 15 (0x0F), then LDR200 is 240 (0xF0).

■ Example 5.5.4 Inversion

Script

```
[LDR 200] = ~[LDR 100];
```

Operation description

The bits in the value of LDR100 are flipped and stored in LDR200.
For example, if the value of LDR100 is 0, then LDR200 is 65535.

■ Example 5.5.5 Inversion

Script

```
if (([LM 100] & ~ [LM 101]) | [LM 102])
{
    SET([LM 200]);
}
else
{
    RST([LM 200]);
}
```

Operation description

If the bitwise logical OR operation on the value of LM102 and the result of the bitwise logical AND operation on the value of LM100 and the inverted result of the value of LM101 is 1, then LM200 changes to 1.

If the bitwise logical OR operation on the value of LM102 and the result of the bitwise logical AND operation on the value of LM100 and the inverted result of the value of LM101 is 0, then LM200 changes to 0.

The operation is the same as the following ladder diagram.

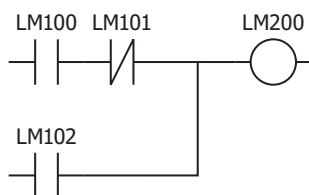

■ Example 5.5.6 Left shift

Script

```
[LDR 300] = [LDR 100] << [LDR 200];
```

Operation description

The value of LDR100 is shifted left by only the amount of the value of LDR200 and the result is stored in LDR300.

For example, if the value of LDR100 is 1 and the value of LDR200 is 3, 1 is shifted 3 bits to the left and the result 8 is stored in LDR300.

■ Example 5.5.7 Right shift

Script

```
[LDR 300] = [LDR 100] >> [LDR 200];
```

Operation description

The value of LDR100 is shifted right by only the amount of the value of LDR200 and the result is stored in LDR300.

For example, if the value of LDR100 is 8 and the value of LDR200 is 3, 8 is shifted 3 bits to the right and the result 1 is stored in LDR300.

5.6 Bit Functions

■ Example 5.6.1 Set a bit

Script

```
SET([LM 100]);
```

Operation description

Turns LM100 to 1. The result is the same as $[LM 100] = 1$.

■ Example 5.6.2 Reset a bit

Script

```
RST([LM 100]);
```

Operation description

Turns LM100 to 0. The result is the same as $[LM 100] = 0$.

■ Example 5.6.3 Invert a bit

Script

```
REV([LM 100]);
```

Operation description

Flips LM100 1 and 0. The result is the same as $[LM 100] = \sim[LM 100]$.

5.7 Word Functions

● Arithmetic operations

■ Example 5.7.1 Maximum value

Script

```
[LDR 200] = MAX([LDR 100], [LDR 110], [LDR 120], [LDR 130], [LDR 140]);
```

Operation description

Out of the values stored in LDR100, LDR110, LDR120, LDR130, and LDR140, stores the maximum value in LDR200. Up to 15 arguments can be used.

■ Example 5.7.2 Minimum value

Script

```
[LDR 200] = MIN([LDR 100], [LDR 110], [LDR 120], [LDR 130], [LDR 140]);
```

Operation description

Out of the values stored in LDR100, LDR110, LDR120, LDR130, and LDR140, stores the minimum value in LDR200. Up to 15 arguments can be used.

■ Example 5.7.3 Exponential function

Script

```
[D 10] = EXP([D 20]);
```

Operation description

Calculates the exponential function of the value of D20 and the result is stored in D10. Only the data type float32 can be used.

■ Example 5.7.4 Natural logarithm

Script

```
[D 10] = LOGE([D 20]);
```

Operation description

Calculates the natural logarithm of the value of D20 and the result is stored in D10. Only the data type float32 can be used.

■ Example 5.7.5 Common logarithm

Script

```
[D 10] = LOG10([D 20]);
```

Operation description

Calculates the logarithm of the value of D20 with 10 as the base and the result is stored in D10. Only the data type float32 can be used.

■ Example 5.7.6 Power

Script

```
[D 10] = POW([D 20],[D 30]);
```

Operation description

Calculates the power of a value.

For example, when the value of D20 is 10 and the value of D30 is 5, the function calculates 10 to the power of 5 and stores the result in D10.

Only the data type float32 can be used.

■ Example 5.7.7 Square root**Script**

```
[D 10] = ROOT([D 20]);
```

Operation description

Calculates the square root of the value of [D20] and the result is stored in [D10]. Only the data type float32 can be used.

■ Example 5.7.8 Sine**Script**

```
[D 10] = SIN([D 20]);
```

Operation description

Calculates the sine of the radian value of D20 and stores the result in D10. Only the data type float32 can be used.

■ Example 5.7.9 Cosine**Script**

```
[D 10] = COS([D 20]);
```

Operation description

Calculates the cosine of the radian value of D20 and stores the result in D10. Only the data type float32 can be used.

■ Example 5.7.10 Tangent**Script**

```
[D 10] = TAN([D 20]);
```

Operation description

Calculates the tangent of the radian value of D20 and stores the result in D10. Only the data type float32 can be used.

■ Example 5.7.11 Arcsine**Script**

```
[D 10] = ASIN([D 20]);
```

Operation description

Calculates the arcsine of the value of D20 and stores the result as radians in D10. Only the data type float32 can be used.

■ Example 5.7.12 Arccosine**Script**

```
[D 10] = ACOS([D 20]);
```

Operation description

Calculates the arccosine of the value of D20 and stores the result as radians in D10. Only the data type float32 can be used.

■ Example 5.7.13 Arctangent**Script**

```
[D 10] = ATAN([D 20]);
```

Operation description

Calculates the arctangent of the value of D20 and stores the result as radians in D10.
Only the data type float32 can be used.

■ Example 5.7.14 Convert angle to radians**Script**

```
[D 10] = RAD([D 20]);
```

Operation description

Converts the value of D20 from degrees (°) to radians and stores the result in D10.
Only the data type float32 can be used.

■ Example 5.7.15 Convert radians to angle**Script**

```
[D 10] = DEG([D 20]);
```

Operation description

Converts the value of D20 from radians to degrees (°) and stores the result in D10.
Only the data type float32 can be used.

- Data type conversions

- **Example 5.7.16** Convert BCD to binary

Script

```
[LDR 200] = BCD2BIN([LDR 100]);
```

Operation description

Converts the BCD value in LDR100 to a binary value and stores it in LDR200.

For example, if the BCD value 10 (16 as a binary value) is stored in LDR100, 10 (binary value) is stored in LDR200.

- **Example 5.7.17** Convert binary to BCD

Script

```
[LDR 200] = BIN2BCD([LDR 100]);
```

Operation description

Converts the binary value in LDR100 to a BCD value and stores it in LDR200.

For example, if the binary value 16 (10 as a BCD value) is stored in LDR100, 16 (BCD value) is stored in LDR200.

- **Example 5.7.18** Convert float32 to binary

Script

```
[LDR 200] = FLOAT2BIN([LDR 100]);
```

Operation description

Converts the float value in LDR100 to a binary value and stores it in LDR200.

For example, if the float value 1234 (0x449A4000 as a binary value) is stored in LDR100, 1234 (binary value) is stored in LDR200. If the float value 1234.56 (0x449A51EC as a binary value) is stored in LDR100, the value after the decimal point is discarded and 1234 (binary value) is stored in LDR200.

- **Example 5.7.19** Convert binary to float32

Script

```
[LDR 200] = BIN2FLOAT([LDR 100]);
```

Operation description

Converts the binary value in LDR100 to a float value and stores it in LDR200.

For example, if the binary value 1234 is stored in LDR100, the float value 1234 (0x449A4000 as a binary value) is stored in LDR200.

■ Example 5.7.20 Convert decimal to string

Script

```
DEC2ASCII([LDR 100], [LDR 200]);
```

Operation description

Converts the decimal numeric value in LDR200 to a string and stores it in order with LDR100 as the starting address.



- This function can be used with data types BIN16(+), BIN16(+/-), BIN32(+), BIN32(+/-), BCD4, and BCD8.
- Only internal devices can be used.
- When using functions that handle strings, check the **Storage Method of string data** setting on the **System** tab in the Project Settings dialog box. Depending on the setting, the upper and lower bytes are stored in the reverse of the following explanation.
For details, refer to Chapter 3 "3.1 System Tab" on page 3-19.
- A NULL terminating character (0x00) is added to the end of the string.

Converting 1234 (when the data type is BIN16+)

Device	Stored value	Stored value	
		Upper byte	Lower byte
LDR200	1234		
LDR100		'1' = 0x31	'2' = 0x32
LDR101		'3' = 0x33	'4' = 0x34
LDR102		0x00	0x00

Terminating character

Converting -12345 (when the data type is BIN16+/-)

Device	Stored value	Stored value	
		Upper byte	Lower byte
LDR200	-12345		
LDR100		'.' = 0x2D	'1' = 0x31
LDR101		'2' = 0x32	'3' = 0x33
LDR102		'4' = 0x34	'5' = 0x35
LDR103		0x00	0x00

Terminating character

Converting 1234567890 (when the data type is BIN32+)

Device	Stored value	Stored value	
		Upper byte	Lower byte
LDR200	1234567890		
LDR201			
LDR100		'1' = 0x31	'2' = 0x32
LDR101		'3' = 0x33	'4' = 0x34
LDR102		'5' = 0x35	'6' = 0x36
LDR103		'7' = 0x37	'8' = 0x38
LDR104		'9' = 0x39	'0' = 0x30
LDR105		0x00	0x00

Terminating character

Converting -1234567890 (when the data type is BIN32+/-)

Device	Stored value	Stored value	
		Upper byte	Lower byte
LDR200	-1234567890		
LDR201			
LDR100		'.' = 0x2D	'1' = 0x31
LDR101		'2' = 0x32	'3' = 0x33
LDR102		'4' = 0x34	'5' = 0x35
LDR103		'6' = 0x36	'7' = 0x37
LDR104		'8' = 0x38	'9' = 0x39
LDR105		'0' = 0x30	0x00

Terminating character

■ Example 5.7.21 Convert string to decimal

Script

```
[LDR 100] = ASCII2DEC([LDR 200]);
```

Operation description

Converts the stored string starting at LDR200 to a decimal and stores the result in LDR100.

The number of digits that can be converted is the maximum number of digits for each data type with added sign.

If the string to convert contains NULL or characters that cannot be converted to numeric values, the string is converted up to that character.



- This function can be used with data types BIN16(+), BIN16(+/-), BIN32(+), BIN32(+/-), BCD4, and BCD8.
- Only internal devices can be used.
- When using functions that handle strings, check the **Storage Method of string data** setting on the **System** tab in the Project Settings dialog box. Depending on the setting, the upper and lower bytes are stored in the reverse of the following explanation.
For details, refer to Chapter 3 “3.1 System Tab” on page 3-19.

Setting the string “1234” (when the data type is BIN16+)

Device	Stored value		→	Device	Stored value
	Upper byte	Lower byte			
LDR200	'1' = 0x31	'2' = 0x32		LDR100	1234
LDR201	'3' = 0x33	'4' = 0x34			
LDR202	0x00	0x00			

Terminating character

Setting the string “1234567” (when the data type is BIN16+)

Device	Stored value		→	Device	Stored value
	Upper byte	Lower byte			
LDR200	'1' = 0x31	'2' = 0x32		LDR100	12345
LDR201	'3' = 0x33	'4' = 0x34			
LDR202	'5' = 0x35	'6' = 0x36			
LDR203	'7' = 0x37	0x00			

Terminating character

Setting the string “-12345” (when the data type is BIN16+/-)

Device	Stored value		→	Device	Stored value
	Upper byte	Lower byte			
LDR200	'-' = 0x2D	'1' = 0x31		LDR100	-12345
LDR201	'2' = 0x32	'3' = 0x33			
LDR202	'4' = 0x34	'5' = 0x35			
LDR203	0x00	0x00			

Terminating character

String “1234567890” (when the data type is BIN32+)

Device	Stored value		→	Device	Stored value
	Upper byte	Lower byte			
LDR200	'1' = 0x31	'2' = 0x32		LDR100 - 101	1234567890
LDR201	'3' = 0x33	'4' = 0x34			
LDR202	'5' = 0x35	'6' = 0x36			
LDR203	'7' = 0x37	'8' = 0x38			
LDR204	'9' = 0x39	'0' = 0x30			
LDR205	0x00	0x00			

Terminating character

● Data comparison and copying

■ Example 5.7.22 Word-unit data comparison

Script

```
[LDR 0] = MEMCMP([LDR 100], [LDR 200], 10);
```

Operation description

Compares the value of 10 words from LDR100 (up to LDR109) with the value of 10 words from LDR200 (up to LDR209).

If the value for each is entirely equal, 1 is stored in LDR0. If even a single one is not equal, 0 is stored.

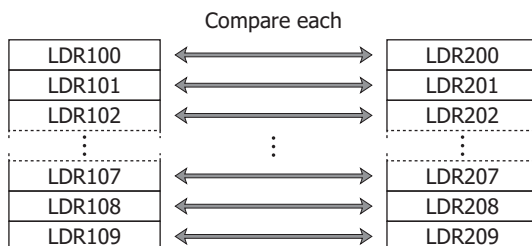

Even if the data type is set to BIN32+, BIN32+/-, BCD8, or float32, the comparison is performed from the starting device in word units.

■ Example 5.7.23 Bit-unit data comparison

Script

```
[LDR 0] = MEMCMP([LDR 100-2], [LM 0], 10);
```

Operation description

Compares the third bit of LDR100 through the third bit of LDR109 with the state of the bits from LM0 to LM9.

If the value for each is entirely equal, 1 is stored in LDR0. If even a single one is not equal, 0 is stored.

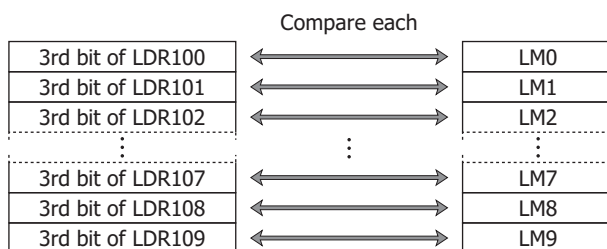

Even if the data type is set to BIN32+, BIN32+/-, BCD8, or float32, the comparison is performed from the starting device in bit units.

■ Example 5.7.24 Word-unit data copy

Script

```
MEMCPY([LDR 100], [LDR 200], 10);
```

Operation description

Copies the value of 10 word devices from LDR200 (up to LDR209) to 10 word devices from LDR100 (up to LDR109).

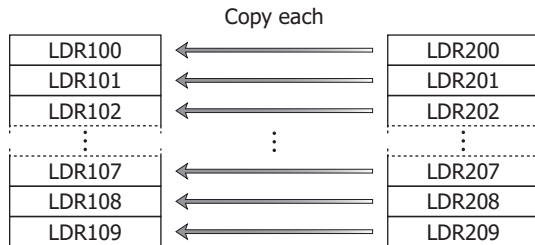

Even if the data type is set to BIN32+, BIN32+/-, BCD8, or float32, the data is copied from the starting device in word units.

■ Example 5.7.25 Bit-unit data copy

Script

```
MEMCPY([LM 0], [LDR 100-2], 10);
```

Operation description

Copies the third bit of 10 words from LDR100 (up to LDR109) to the bit state for 10 bits of devices from LM0 (up to LM9).

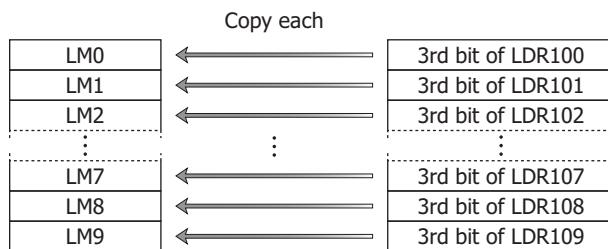

Even if the data type is set to BIN32+, BIN32+/-, BCD8, or float32, the bits are copied from the starting device in bit units.

■ Example 5.7.26 Copy 1 word from bit devices to bit devices^{*1}

Script

```
BITS2BITS(I004, M0000);
```

Operation description

A value of 1 word length from I004 (I004 to I023) is copied to the bit states of a 1 word region from M0000 (M0000 to M0017).

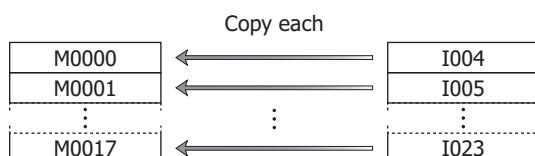

*1 Control function only

- **Example 5.7.27** Copy 1 word from bit devices to a word device^{*1}

Script

```
BITS2WORD(I004, D0000);
```

Operation description

A value of 1 word length from I004 (to I023) is copied to the value of device D0000.

This is the same as BITS2BITS(I004, D0000.0);.

- **Example 5.7.28** Copy 1 word from a word device to bit devices^{*1}

Script

```
WORD2BITS(D0100, M0000);
```

Operation description

The value of device D0100 is copied to the bit states of a value of 1 word length from M0000 (M0000 to M0017).

This is the same as BITS2BITS(D1000.0, M0000);.

*1 Control function only

● String operations ²

When using functions that handle string data, check the **Storage Method of string data** setting in the project settings.

For details, refer to Chapter 3 “3.1 System Tab” on page 3-19.

■ Example 5.7.29 Copy a string

Script

```
STRCUT([LDR 100], [LDR 200], 2, 3);
```

Operation description

Stores in order from LDR100 character count 3 (3 characters worth) from start position 2 (starting from 0, so the 3rd character) of the string “ABCDEFGH” that starts from LDR200.



The start position can be specified in the range from 0 to 127, the character count can be specified in the range from 1 to 128.

Copy from string “ABCDEFGH” at start position 2, character count 3

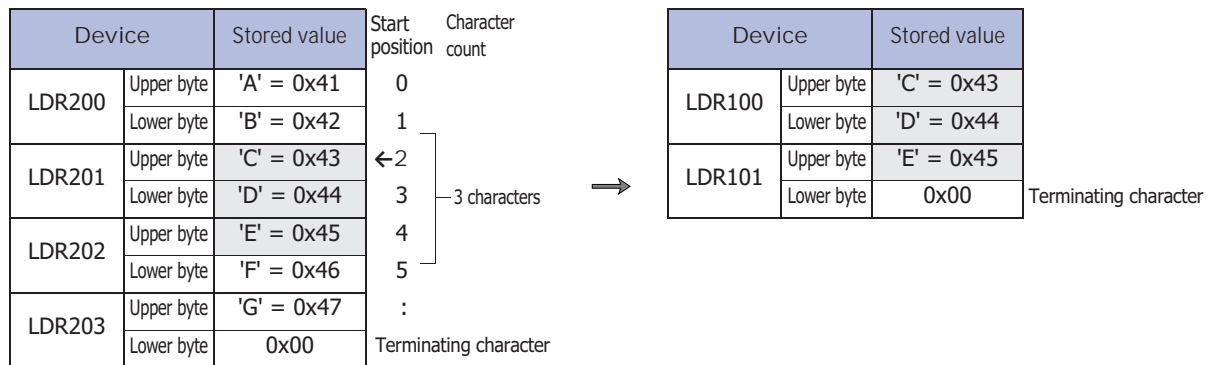

Script

```
STRUCT([LDR 100], [LDR 200], 1, 4);
```

Copy from string “ABCDEFGH” at start position 1, character count 4

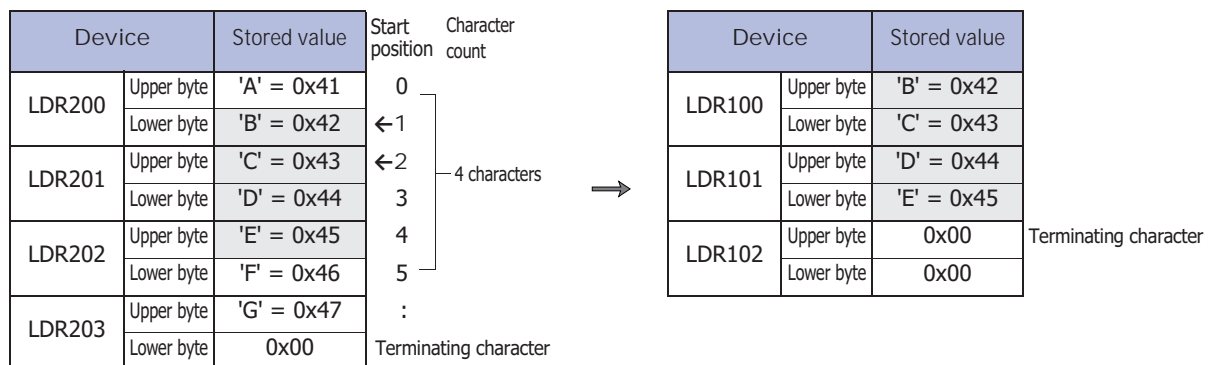

*2 HMI function only

■ Example 5.7.30 Count a string

Script

```
[LDR 100] = STRLEN([LDR 200]);
```

Operation description

Finds the length (character count) of the string starting from LDR200 and stores that in LDR100.



- The only devices that can be specified as function arguments in string operations are internal devices.
- The NULL terminating character (0x00) is the end of the string. (The terminating character is not included in the string length.)

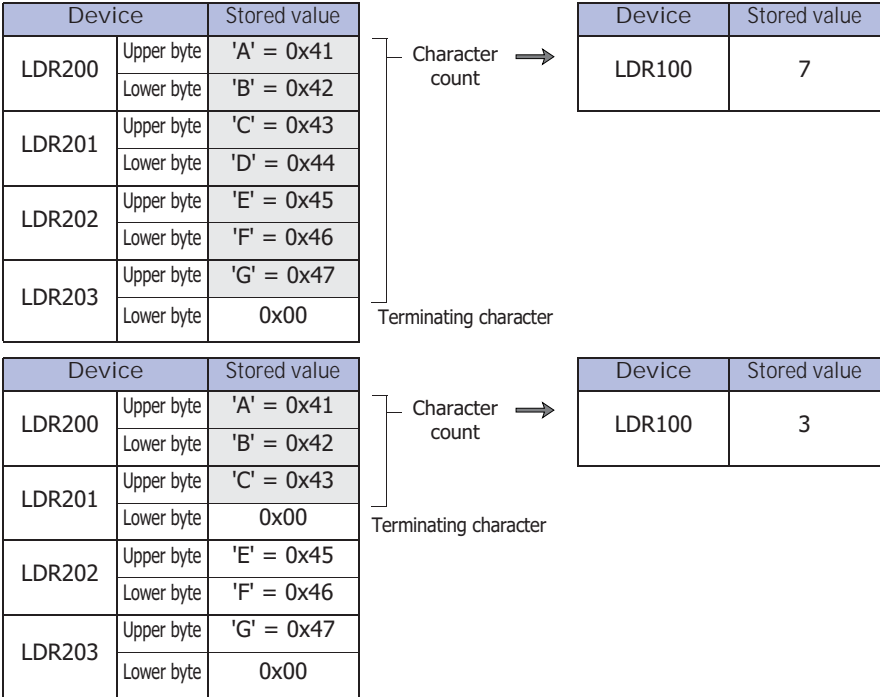

■ Example 5.7.31 Concatenate strings

Script

```
STRCAT([LDR 100], [LDR 200]);
```

Operation description

Concatenates the string starting from LDR200 to the string starting from LDR100.



- Only internal devices can be used.
- The NULL terminating character (0x00) is the end of the string. (The terminating character is not included in the string length.)

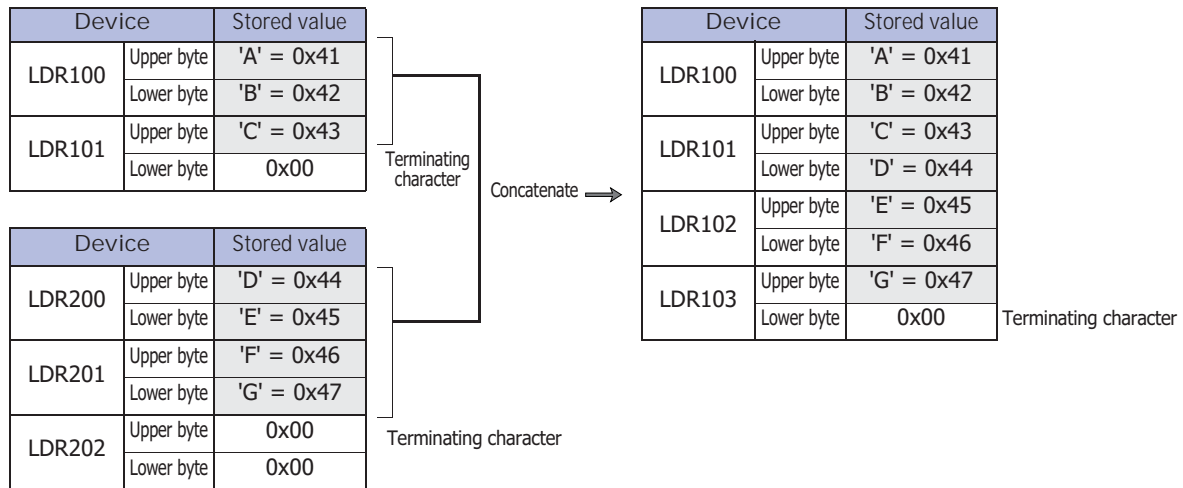

■ Example 5.7.32 Search a string

Script

```
[LDR 0] = STRSTR([LDR 100], [LDR 200]);
```

Operation description

Searches for the search string "DEFG" that starts from LDR200 in the string to be searched "ABCDEFGHIJKLMNO" that starts from LDR100 and stores the position of the occurrence of the string in LDR0. If not found, -1 is stored in LDR0.

If "?" is specified as a character to search for, it is handled as an arbitrary single-byte character.

When specifying "~?" (0x3F) as a character, specify it as "~~?" (0x7E3F) in two bytes.

When specifying "~" (0x7E) as a character, specify it as "~~" (0x7E7E) in two bytes.



- The maximum number for the search string is 128 characters.
- Only internal devices can be used.

When searching for "DEFG" and the string was found

Search string			String to be searched			Search result		
Device	Upper byte	Stored value	Device	Upper byte	Stored value	Position	Device	Stored value
LDR200	Upper byte	'D' = 0x44	LDR100	Upper byte	'A' = 0x41	0	LDR0	3
	Lower byte	'E' = 0x45		Lower byte	'B' = 0x42	1		
LDR201	Upper byte	'F' = 0x46	LDR101	Upper byte	'C' = 0x43	2		
	Lower byte	'G' = 0x47		Lower byte	'D' = 0x44	3		
LDR202	Upper byte	0x00	LDR102	Upper byte	'E' = 0x45	4		
	Lower byte	0x00		Lower byte	'F' = 0x46	5		
			LDR103	Upper byte	'G' = 0x47	6		
				Lower byte	'H' = 0x48	7		
			LDR104	Upper byte	'I' = 0x49	8		
				Lower byte	'J' = 0x4A	9		
			LDR105	Upper byte	'K' = 0x47	10		
				Lower byte	'L' = 0x4C	11		
			LDR106	Upper byte	'M' = 0x4D	12		
				Lower byte	'N' = 0x4E	13		
			LDR107	Upper byte	'O' = 0x4F	14		
				Lower byte	0x00	Terminating character		

When searching for "WXYZ" and the string was not found

Search string			String to be searched			Search result		
Device	Upper byte	Stored value	Device	Upper byte	Stored value	Position	Device	Stored value
LDR200	Upper byte	'W' = 0x57	LDR100	Upper byte	'A' = 0x41	0	LDR0	-1
	Lower byte	'X' = 0x58		Lower byte	'B' = 0x42	1		
LDR201	Upper byte	'Y' = 0x59	LDR101	Upper byte	'C' = 0x43	2		
	Lower byte	'Z' = 0x5A		Lower byte	'D' = 0x44	3		
LDR202	Upper byte	0x00	LDR102	Upper byte	'E' = 0x45	4		
	Lower byte	0x00		Lower byte	'F' = 0x46	5		
			LDR103	Upper byte	'G' = 0x47	6		
				Lower byte	'H' = 0x48	7		
			LDR104	Upper byte	'I' = 0x49	8		
				Lower byte	'J' = 0x4A	9		
			LDR105	Upper byte	'K' = 0x47	10		
				Lower byte	'L' = 0x4C	11		
			LDR106	Upper byte	'M' = 0x4D	12		
				Lower byte	'N' = 0x4E	13		
			LDR107	Upper byte	'O' = 0x4F	14		
				Lower byte	0x00	Terminating character		

When searching for "?" as an arbitrary single-byte character

Search string			String to be searched			Search result		
Device	Upper byte	Stored value	Device	Upper byte	Stored value	Position	Device	Stored value
LDR200	Upper byte	'E' = 0x45	LDR100	Upper byte	'A' = 0x41	0	LDR0	4
	Lower byte	'?' = 0x3F		Lower byte	'B' = 0x42	1		
LDR201	Upper byte	'G' = 0x47	LDR101	Upper byte	'C' = 0x43	2		
	Lower byte	'H' = 0x48		Lower byte	'D' = 0x44	3		
LDR202	Upper byte	0x00	LDR102	Upper byte	'E' = 0x45	4		
	Lower byte	0x00		Lower byte	'F' = 0x46	5		
		Terminating character	LDR103	Upper byte	'G' = 0x47	6		
			Lower byte	'H' = 0x48	7			
			LDR104	Upper byte	'I' = 0x49	8		
			Lower byte	'J' = 0x4A	9			
			LDR105	Upper byte	'K' = 0x47	10		
			Lower byte	'L' = 0x4C	11			
			LDR106	Upper byte	'M' = 0x4D	12		
			Lower byte	'N' = 0x4E	13			
			LDR107	Upper byte	'O' = 0x4F	14		
			Lower byte	0x00	Terminating character			

When searching for "?" as a character

Search string			String to be searched			Search result		
Device	Upper byte	Stored value	Device	Upper byte	Stored value	Position	Device	Stored value
LDR200	Upper byte	'E' = 0x45	LDR100	Upper byte	'A' = 0x41	0	LDR0	4
	Lower byte	'~' = 0x7E		Lower byte	'B' = 0x42	1		
LDR201	Upper byte	'?' = 0x3F	LDR101	Upper byte	'C' = 0x43	2		
	Lower byte	'G' = 0x47		Lower byte	'D' = 0x44	3		
LDR202	Upper byte	'H' = 0x48	LDR102	Upper byte	'E' = 0x45	4		
	Lower byte	0x00		Lower byte	'?' = 0x3F	5		
		Terminating character	LDR103	Upper byte	'G' = 0x47	6		
			Lower byte	'H' = 0x48	7			
			LDR104	Upper byte	'I' = 0x49	8		
			Lower byte	'J' = 0x4A	9			
			LDR105	Upper byte	'K' = 0x47	10		
			Lower byte	'L' = 0x4C	11			
			LDR106	Upper byte	'M' = 0x4D	12		
				Lower byte	'N' = 0x4E	13		
			LDR107	Upper byte	'O' = 0x4F	14		
				Lower byte	0x00	Terminating character		

When searching for "~" as a character

Search string			String to be searched			Search result		
Device	Upper byte	Stored value	Device	Upper byte	Stored value	Position	Device	Stored value
LDR200	Upper byte	'E' = 0x45	LDR100	Upper byte	'A' = 0x41	0	LDR0	4
	Lower byte	'~' = 0x7E		Lower byte	'B' = 0x42	1		
LDR201	Upper byte	'~' = 0x7E	LDR101	Upper byte	'C' = 0x43	2		
	Lower byte	'G' = 0x47		Lower byte	'D' = 0x44	3		
LDR202	Upper byte	'H' = 0x48	LDR102	Upper byte	'E' = 0x45	4		
	Lower byte	0x00		Lower byte	'~' = 0x7E	5		
		Terminating character	LDR103	Upper byte	'G' = 0x47	6		
			Lower byte	'H' = 0x48	7			
			LDR104	Upper byte	'I' = 0x49	8		
			Lower byte	'J' = 0x4A	9			
			LDR105	Upper byte	'K' = 0x47	10		
			Lower byte	'L' = 0x4C	11			
			LDR106	Upper byte	'M' = 0x4D	12		
				Lower byte	'N' = 0x4E	13		
			LDR107	Upper byte	'O' = 0x4F	14		
				Lower byte	0x00	Terminating character		

● Drawing ²

■ Example 5.7.33 Draw a line

Script

```
LINE(20, 20, 60, 60, 3, 1, 20);
```

Operation description

Draws a line connecting the start coordinates X=20, Y=20 and the end coordinates X=60, Y=60 on the screen where the script is running. The line has a line width of 3 (3 pixels), line type of 1 (solid line), and line color of 20 (red).

■ Example 5.7.34 Draw a line (omitting arguments)

Script

```
LINE(0, 0, 150, 100);
```

Operation description

Draws a line connecting the start coordinates X=0, Y=0 and the end coordinates X=150, Y=100 on the screen where the script is running. The line width, line type, and line color have been omitted, so the line's line width is 1 (1 pixel), the line type is 1 (solid line), and the line color is 255 (white).

■ Example 5.7.35 Draw a rectangle

Script

```
RECTANGLE(20, 20, 100, 60, 1, 2, 24, 22, 13, 2, 5);
```

Operation description

Draws a rectangle with the start coordinates (the coordinates of the rectangle's upper-left corner) X=20, Y=20 and the end coordinates (the coordinates of the rectangle's lower-right corner) X=100, Y=60 on the screen where the script is running. The rectangle's line width is 1 (1 pixel), line type is 2 (dotted line), foreground color is 24 (green), background color is 22 (yellow), pattern is 13 (tint), rounding type is 2 (curve), and rounding radius is 5 (5 pixels).

■ Example 5.7.36 Draw a rectangle (omitting arguments)

Script

```
RECTANGLE(0, 0, 150, 100);
```

Operation description

Draws a rectangle with the start coordinates (the coordinates of the rectangle's upper-left corner) X=0, Y=0 and the end coordinates (the coordinates of the rectangle's lower-right corner) X=150, Y=100 on the screen where the script is running. The line width, line type, foreground color, background color, pattern, rounding type, and rounding radius are omitted, so the rectangle's line width is 1 (1 pixel), line type is 1 (solid line), foreground color and background color is 255 (white), pattern is 0 (none), rounding type is 0 (none), and rounding radius is 0 (0 pixels).

■ Example 5.7.37 Draw a circle or ellipse

Script

```
CIRCLE(100, 100, 60, 60, 1, 2, 26, 0, 4);
```

Operation description

Draws a circle with the center coordinate X=100, Y=100, the X-axis radius 60 pixels, and the Y-axis radius 60 pixels. The circle's line width is 1 (1 pixel), line type is 2 (dotted line), foreground color is 26 (light blue), background color is 0 (black), and pattern is 4 (foreground 50%).

■ Example 5.7.38 Draw a circle or ellipse (omitting arguments)

Script

```
CIRCLE(100, 100, 80, 40);
```

Operation description

Draws an ellipse with the center coordinate X=100, Y=100, the X-axis radius 80 pixels, and the Y-axis radius 40 pixels. The line width, line type, foreground color, background color, and pattern are omitted, so the ellipse's line width is 1 (1 pixel), line type is 1 (solid line), foreground color and background color is 255 (white), and pattern is 0 (none).

*2 HMI function only

- Indirect assignment

- **Example 5.7.39** Indirect read

Script

```
[LDR 200] = OFFSET([LDR 10],[D 20]);
```

Operation description

When the value of D20 is 8, the value of LDR18, the device 8 words from LDR10, is read and stored in LDR200.



- **Example 5.7.40** Indirect write

Script

```
OFFSET([LDR 10],[D 20]) = 1234;
```

Operation description

When the value of D20 is 3, the constant 1234 is stored in LDR13, the device 3 words from LDR10.

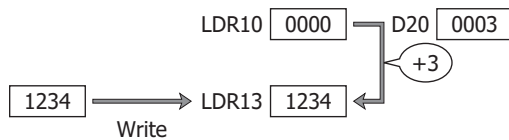

6 Important Notes

This section describes important notes when defining a script.

6.1 Important Notes Regarding the While Definition

- **Define so it will not go into an infinite loop.**

The execution expression is repeatedly executed while the conditional expression is satisfied. However, it will go into an infinite loop when the conditional expression is satisfied continually.

```
[LDR 100] = 10;

while (0 != [LDR 100])
{
    [LDR 200] = [LDR 200] + 1;
}
```

In the conditional expression of the while definition, it states to exit the loop when the value of LDR100 turns 0. However, the value stored in the LDR100 is not changed after storing 10 in the first line of the script, so it will go into an infinite loop.

When using the while definition, define it so it will not go into an infinite loop.

The value of LDR100 will become 0 when the while definition is repeated 10 times in the next example, and it will get out of the while definition.

```
[LDR 100] = 10;

while (0 != [LDR 100])
{
    [LDR 200] = [LDR 200] + 1;
    [LDR 100] = [LDR 100] - 1;
}
```

- **Define it so it will not continue the process for longer than the time limit.**

In a script of HMI function when the processing of a single script continues for more than the time limit due to a while definition, etc., an execution time over error occurs and that script will be halted. Define the script so the execution time for one script does not exceed 3,000 milliseconds.

For details, refer to "1.4 Script Error of HMI Function" on page 20-4.

- **Do not write into the external device address.**

In a script of HMI function, a script error occurs when writing to external device addresses in a while definition.

6.2 Number of Devices That Can Be Used

Number of external device addresses that can be set in single script with WindO/I-NV3 are 64 for read device and 64 for write device.

When the total number of write data to an external device address exceeds 64 in a single script while executing a script with Touch, that script will be halted with an error.

6.3 Write Delay

In a script of HMI function the writing process to external device addresses is performed at the end of a script, so it may not operate correctly due to the write delay.

Example where write delay occurs

```
[D 100] = 1000;
[D 200] = [D 100] + 5000;
```

Initial value of D100 is 0.

Since the write destination of 1000 in first line is the external device address, the value is not reflected immediately, and the value of D100 is still 0 when the second line is executed.

Therefore, the value where 5000 is added to 0 (value of D100) would be written to D200 in second line.

The value of D100 will be 1000 and the value of D200 will be 5000 when above script is executed.

There are 2 countermeasures for cases like this.

- Not using the device cache

Write delay does not occur when writing to the internal device, so the calculation is performed only in the internal device, and only the result will be written to the external device address.

```
[LDR 0] = 1000;
[LDR 0] = [LDR 0] + 5000;
[D 200] = [LDR 0];
```

- Using the device cache

Problems with the write delay to the external device address can be avoided by caching the value of the external device address into the internal memory. To use the device cache, setup as follows in WindO/I-NV3.

- 1 On the **Configuration** tab, in the **System Setup** group, click **Project**.

The Project Settings dialog box is displayed.

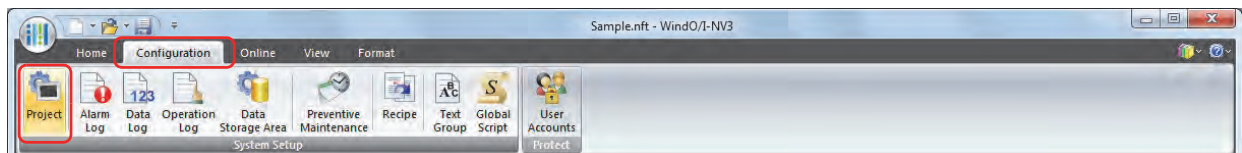

- 2 In the **System** tab, click **Advanced**.

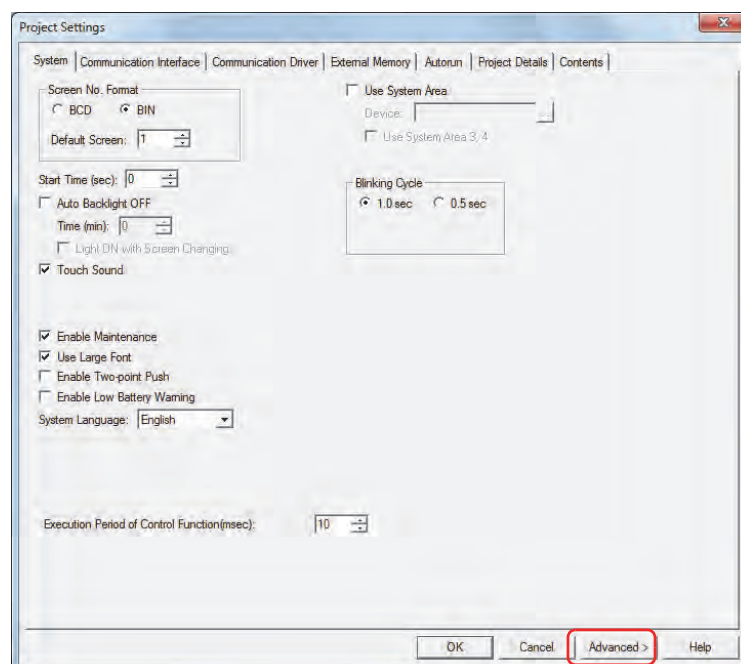

3 Select the **Use Device Cache** check box.

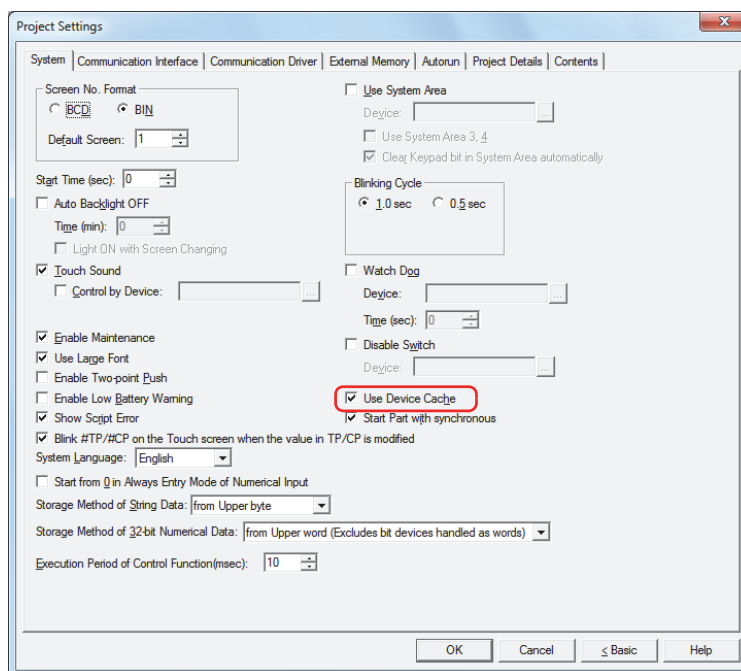

4 Click **OK**.



This setting will be applied not only to the script, but to the whole project.

6.4 About the Priority of the Operator

As a basic rule, operators are calculated in order from left of the line, but when multiple calculations are combined, they are calculated in following priority.

Priority	Operator
High ↑ ↓ Low	()
	! ~ -(Negative number)
	* / %
	+ -(Subtraction)
	<< >>
	&
	^
	< <= > >=
	== !=
	&&
	=

Chapter 21 User Accounts and the Security Function

This chapter describes user accounts and the Security function, how to configure them, and their operation on the Touch and in WindO/I-NV3.

1 Overview

1.1 User Accounts

The Security function protects access to data and Touch displays and operations using accounts. Accounts are the privileges to use the Touch and data. By assigning accounts to users, you can protect the Touch from being inappropriately operated and protect project data from alterations and misuse. Accounts assigned to users are called user accounts.

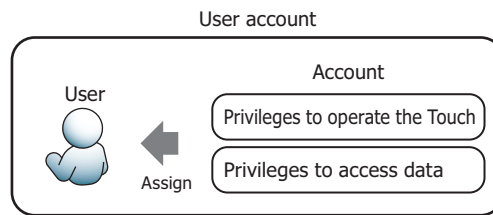

In WindO/I-NV3, security groups are used as accounts.

There are two types of security groups. One type protects access to data. The other type protects Touch displays and operations. To protect access to data, assign one of the provided security groups to a user. To protect Touch displays and operations, assign a user-created security group to a user.

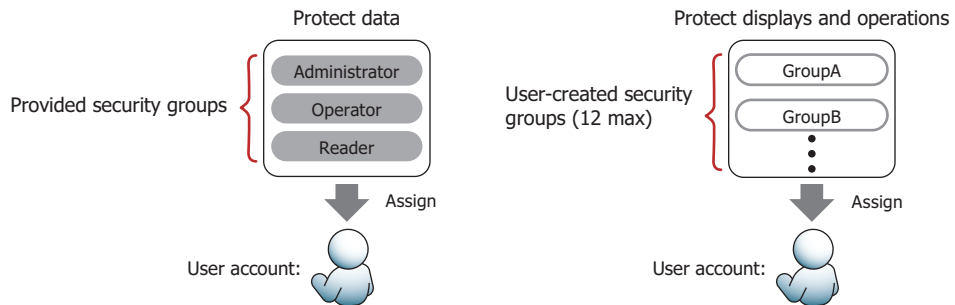

A user name and password are associated with a user account and up to 15 user accounts can be created.

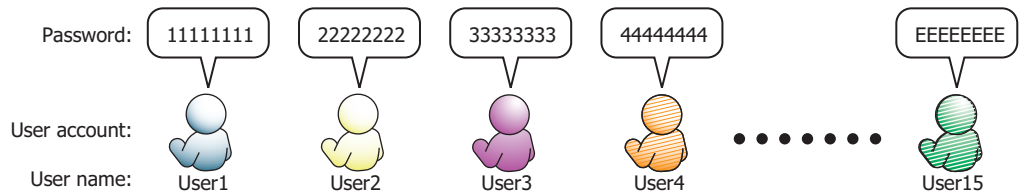

If you configure a password for a user account assigned to a security group, access to data and Touch displays and operations are password protected.

For password protected operations, users are prompted to enter their user name and password as necessary on the Touch Password screen or the WindO/I-NV3 Enter Password dialog box.

Password screen

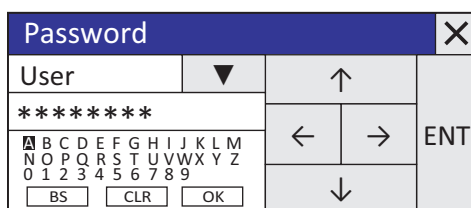

Enter Password dialog box

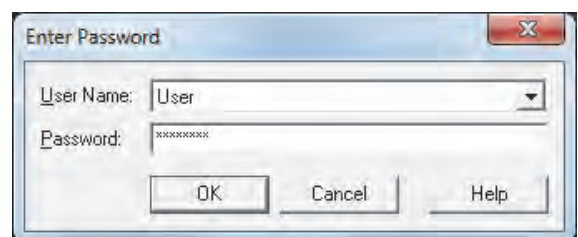

If a password is not configured for a user account, access to data and Touch displays and operations cannot be protected.

1.2 Protecting Data

● Protecting Access to Data

Security groups that protect access to data can perform the following functions.

- Protect from changes by editing project data

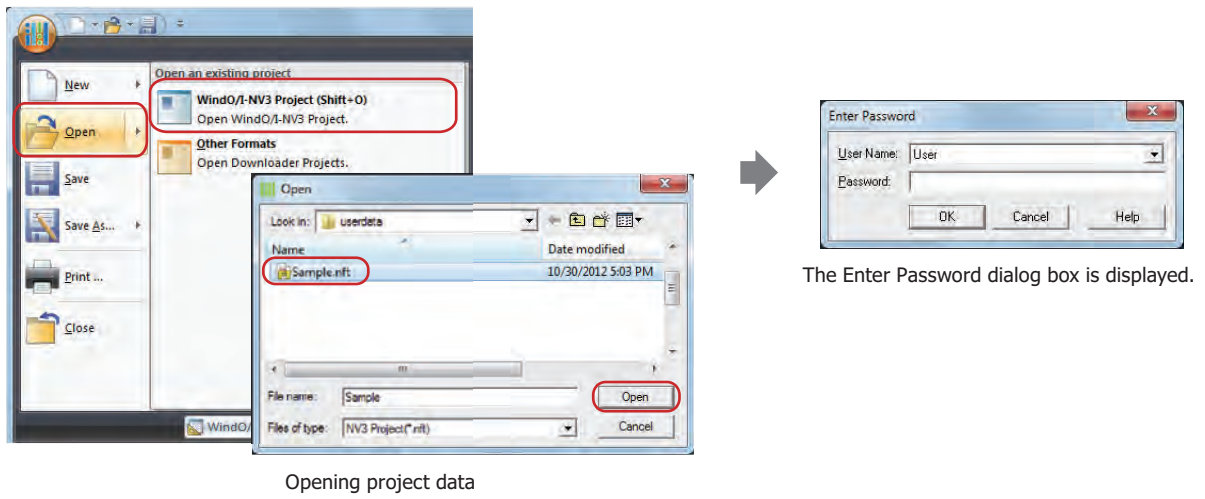

- Protect from alterations or misuse by downloading data

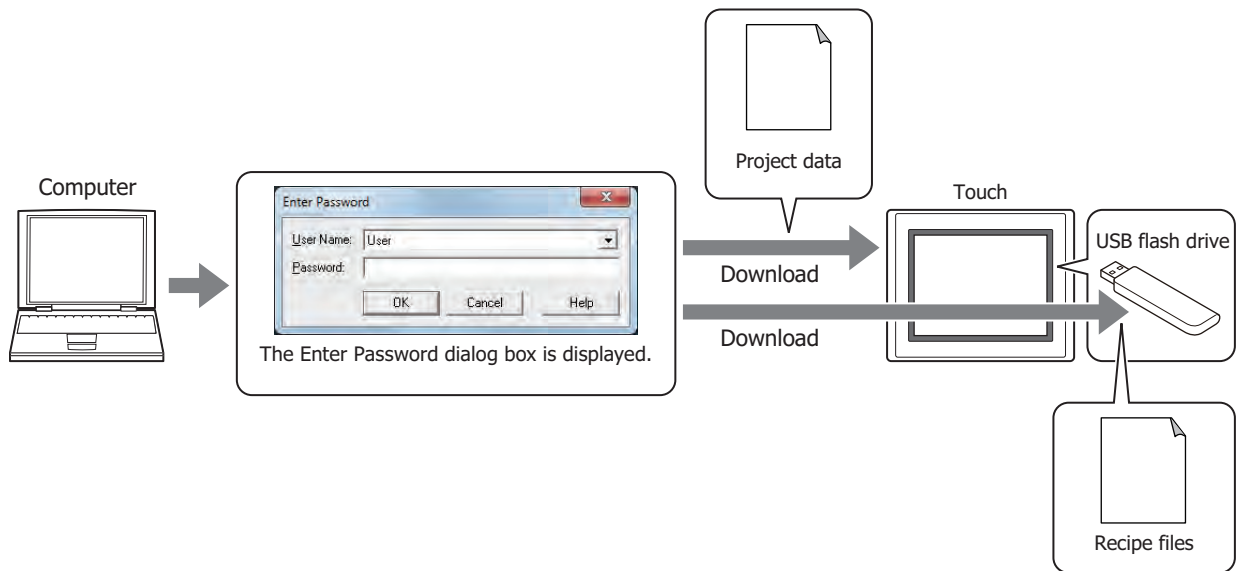

- Protect from the loss of data by upload

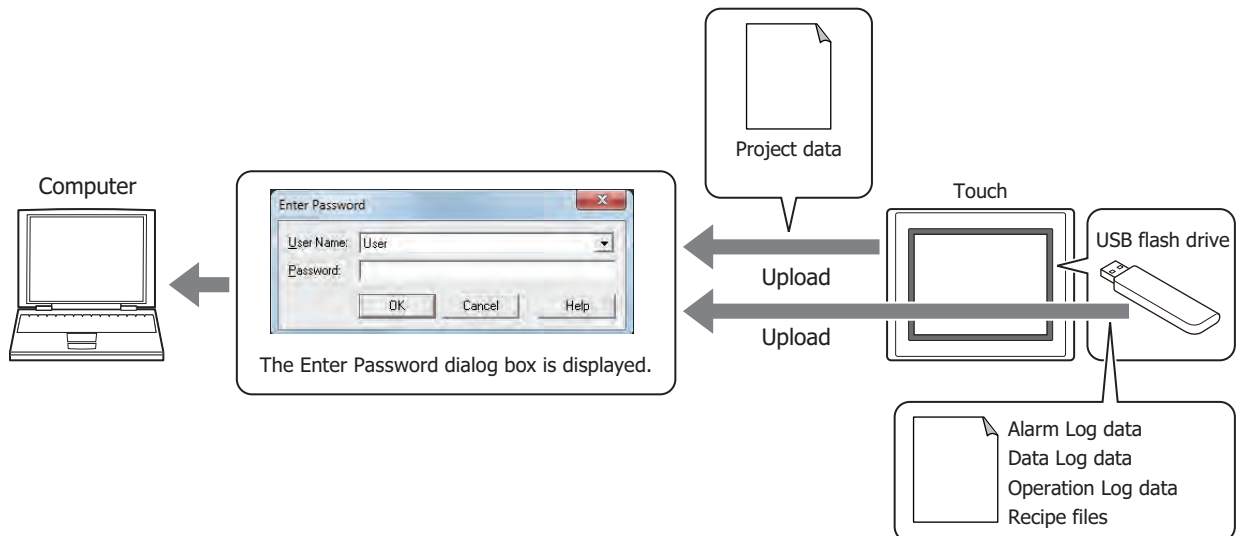

- Protect from data erasures and formatting external memory by unauthorized access

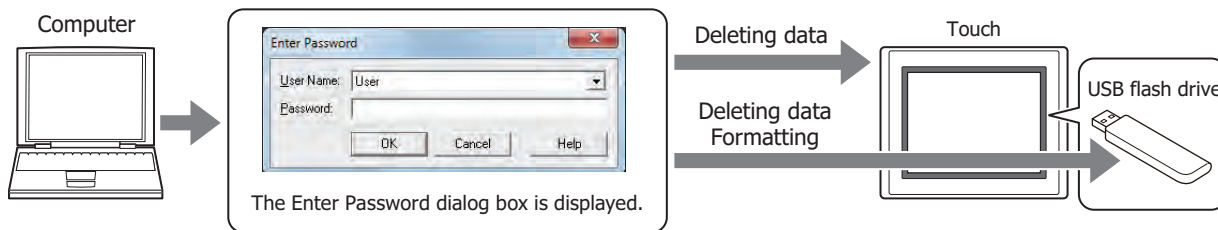

- Protect from alterations and misuse by changing to the System Mode

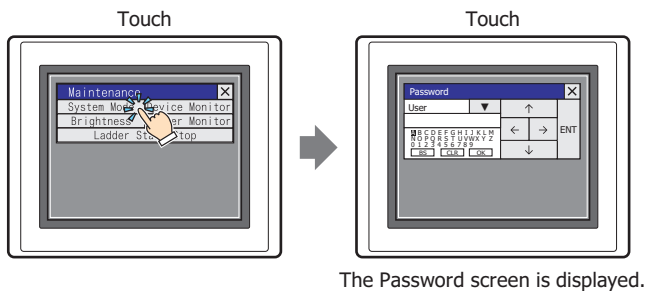

- Protect from unauthorized browsing by displaying Device Monitor

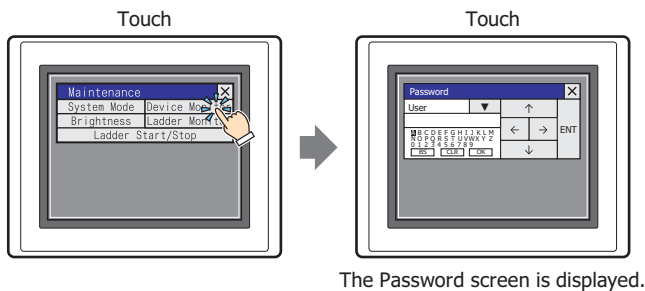

- Protect from the loss of data or alterations by the execution of the USB Autorun function

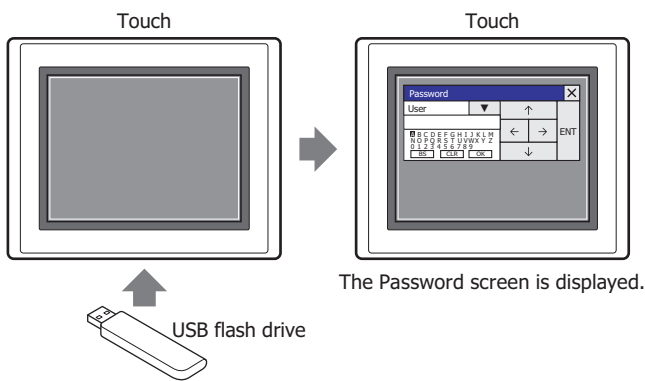

● Security Groups that Protect Access to Data

Three security groups have been provided to protect access to data. These security groups are Administrator, Operator, and Reader. Each one of these security groups can only be assigned to a single user.

■ Administrator

The Administrator group possesses complete access rights to project data. This security group can execute all necessary operations including editing project data and changing Touch project data.

■ Operator

The Operator group can partially change project data by changing values of devices. This security group download data to external memory.

■ Reader

The Reader group can read data stored on external memory.



The provided user account has the security groups Administrator, Operator, and Reader allocated to it. Passwords have not been configured for this user account. To protect access to data, a password must be configured for the user account.

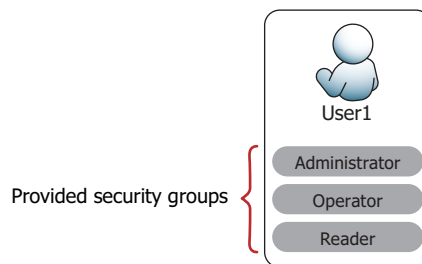

● Operations Subject to Password Protection

If you configure a password for a user account assigned to a security group to protect access to data, access to data is password protected. The operations that are subject to password protection and the security group that the password is valid for are as follows.

Operations subject to password protection		Security group that the password is valid for		
		Administrator	Operator	Reader
Data editing	Opening projects	YES	NO	NO
	Reusing screens	YES	NO	NO
Modifying data	Downloading project data	YES	NO	NO
	Downloading data to external memory ^{*1}	YES	NO	NO
	Downloading data to external memory ^{*1} while the Touch is running	YES	YES	NO
	Uploading project data	YES	NO	NO
	Uploading external memory data ^{*1}	YES	YES	YES
	Deleting all data	YES	NO	NO
	Deleting external memory data ^{*1}	YES	NO	NO
	Formatting external memory ^{*1}	YES	NO	NO
	Switching to the Top Page in the System Mode	YES	NO	NO
	Displaying Device Monitor	YES	YES	NO
Executing the USB Autorun function	YES	NO	NO	



To password protect operations, the lowest level security group out of the security groups enabled with a password must be assigned to a user account.

The security levels, from highest to lowest, are Administrator > Operator > Reader.

Example: To password protect the operation to display Device Monitor, assign the Operator security group to a user account. If a user account assigned to the Operator security group does not exist, the operation is not password protected.

*1 External memory inserted into the Touch

1.3 Protecting Displays and Operations

● Displays and Operations that can be Protected with the Security Function

Security groups can be assigned to users to protect Touch displays and operations. These groups are capable of the following actions.

- Protecting the display of screens

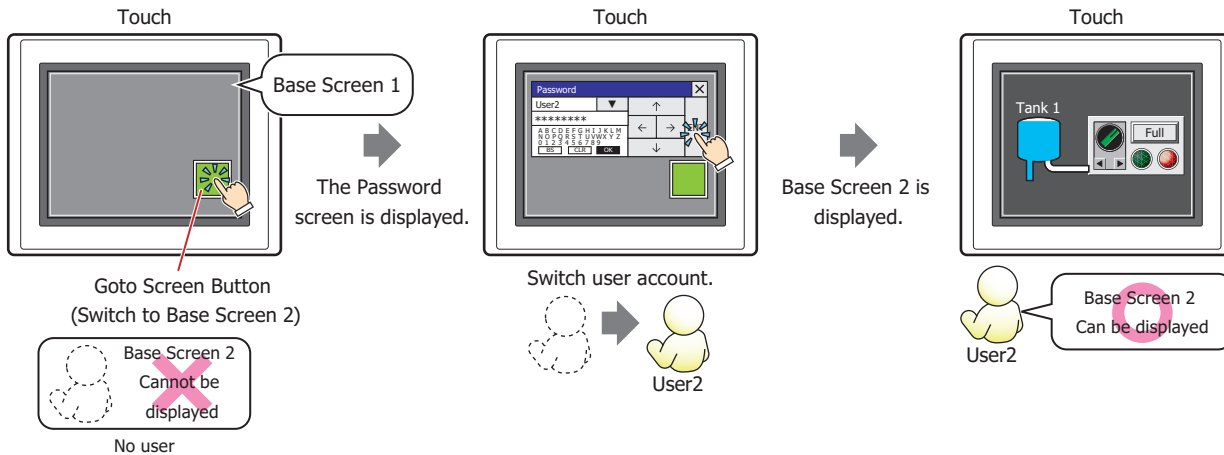

- Protecting the display of parts

Line Chart that can only be displayed with User2

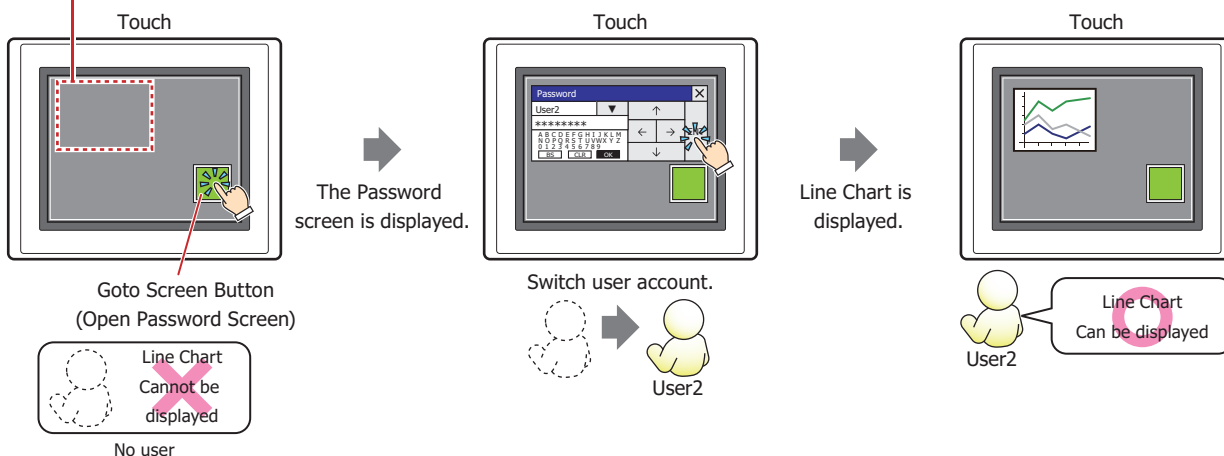

- Protecting the operation of parts

Numerical Input that can only be operated by User2

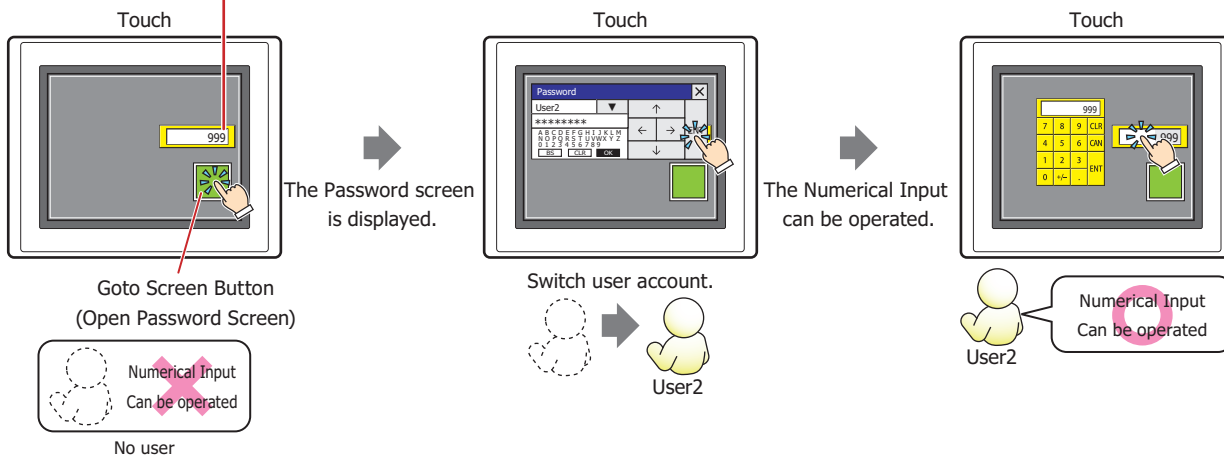



● Security Groups that Protect Touch Displays and Operations

The security groups that protect the display and operation of screens and parts are user-created. Only the user accounts assigned to the same security group as the security group configured for the screens and parts can display and operate those screens and parts.

The security group for screens and parts is configured in the **Options** tab in the Properties dialog box for the screen or part. The input security group to protect operations can only be configured for parts with an input function.

Example: If the user and security group for the part are set as follows:

User Name	 User2	 User3	 User4
Security Group	GroupA	GroupA, GroupB	GroupB

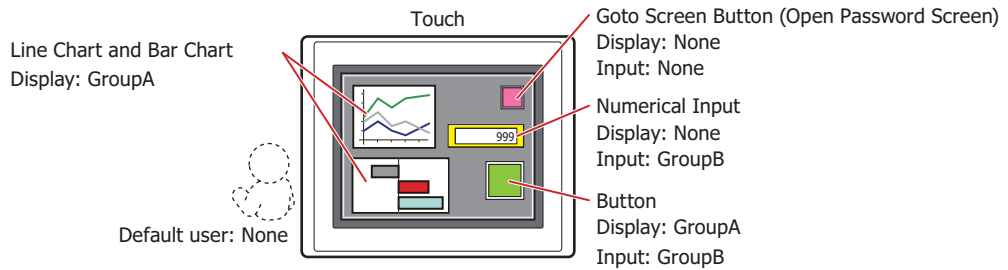

If the password screen is opened and the user switches to User2 in GroupA, the parts for GroupA are displayed. The parts for GroupB cannot be operated.

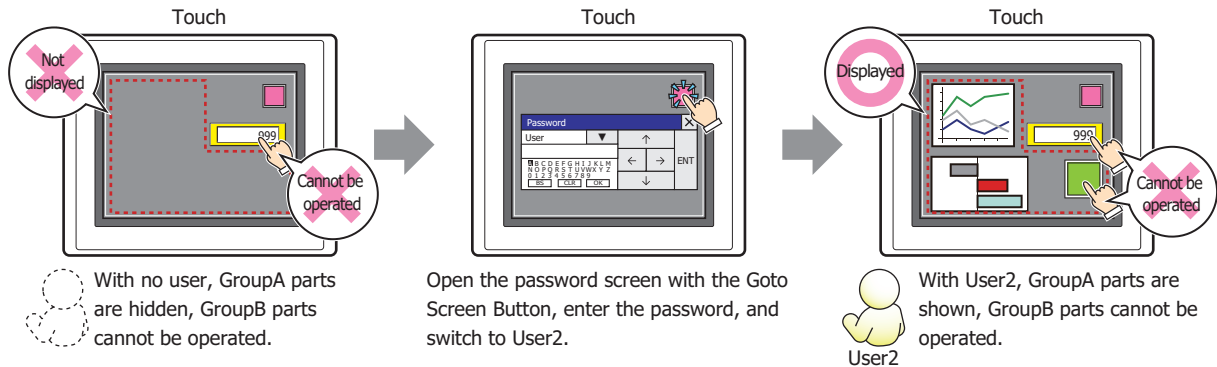

If the password screen is opened and the user switches to User3 in GroupA and GroupB, the parts for GroupA are displayed and the parts for GroupB can be operated.

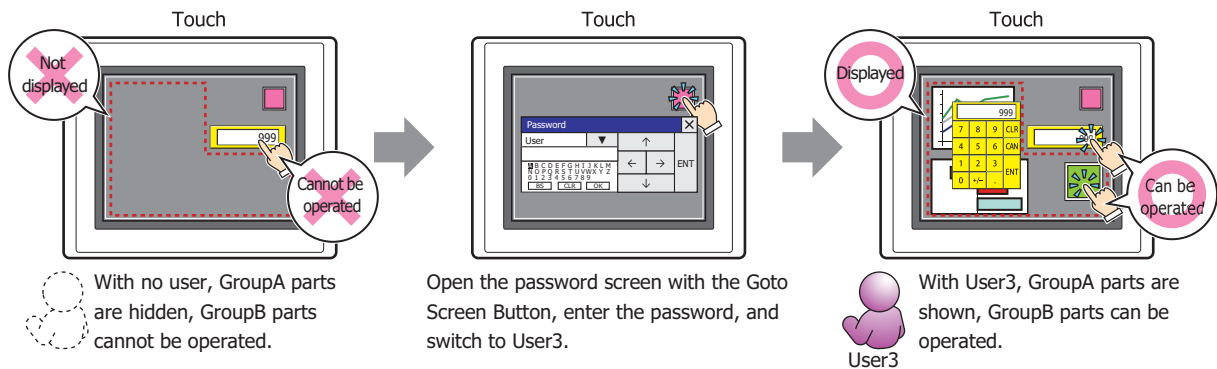

Parts that are not displayed on the screen cannot be operated regardless of the input security group.

If the password screen is opened and the user switches to User4 in GroupB, only the displayed parts for GroupB can be operated. The GroupA parts are not displayed.

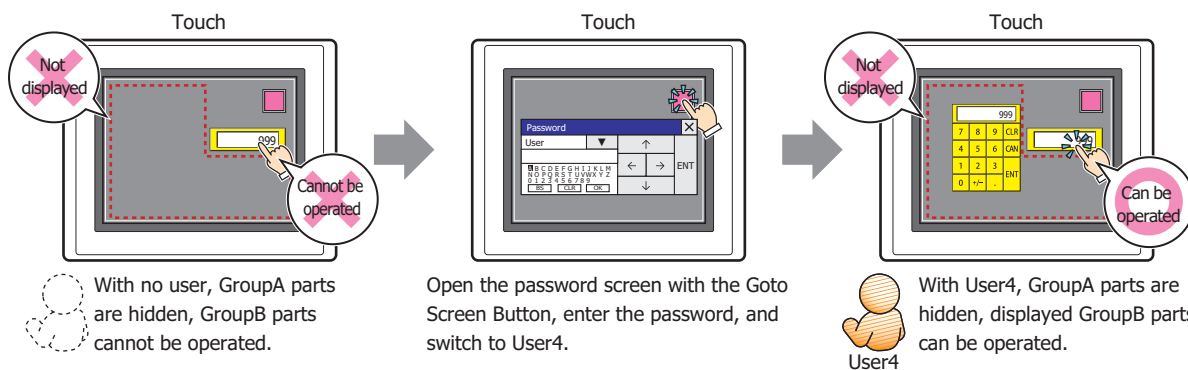

GroupA is not configured for User4, so the button in the lower right of the screen is not displayed. Parts that are not displayed on the screen cannot be operated, even by the user configured with the input security group.

2 Security Function Configuration Procedure

This section describes the configuration procedure for the Security function.

2.1 Creating and Editing User Accounts

● Creating a User Account

- 1 On the **Configuration** tab, in the **Protect** group, click **User Accounts**.

The User Accounts dialog box is displayed.

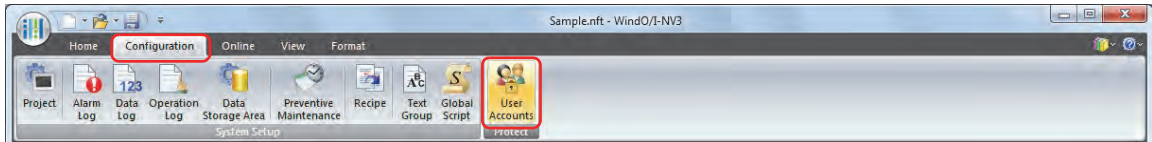

- 2 Select the **Use Security functions** check box.

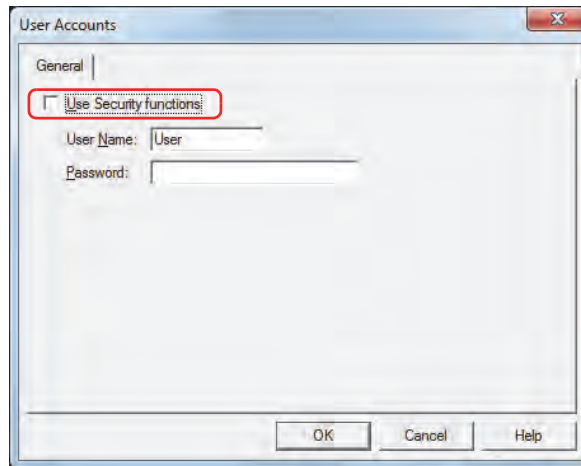

The settings related to user accounts are displayed.

The user account already provided with WindO/I-NV3 is as follows.

No.: 1
 User Name: User
 Password: (blank)
 Security Group: Administrator, Operator, Reader

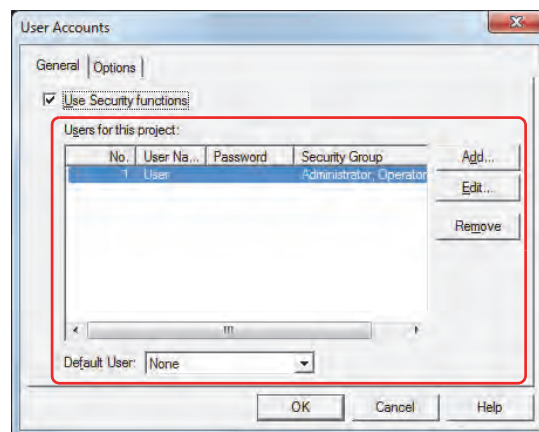

3 Click **Add**.

The New User Account dialog box is displayed.

4 Specify the user number (1 to 15) in **No.**

This number is used when switching the user account according to the value of device.

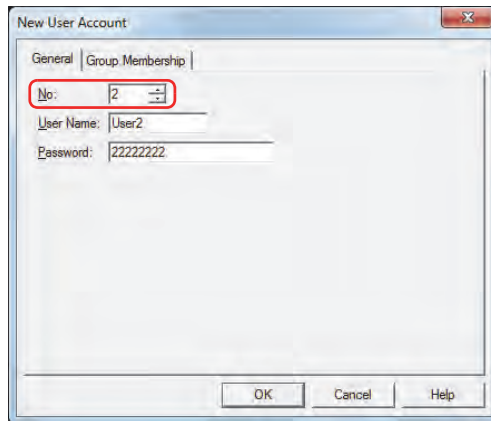
**5** Enter the name for the new user in **User Name**.

The maximum number for the user name is eight characters. Only alphanumeric characters and symbols can be used.



You cannot use the following characters in the user name.

\ / : * ? " < > |

6 Enter the password in **Password**.

The number of characters for the password is 4 to 15. Only uppercase alphabetic characters and numbers can be used.



Write down the password so you do not forget it and save that note in a safe place.

7 Click the **Group Membership** tab.

Assign the security groups to the user being created.

Administrator, **Operator**, and **Reader** have already been provided in **Security Group**. These three security groups cannot be used in multiple user accounts. To use them with the user account being created, delete the security group from the user account they are assigned to beforehand.

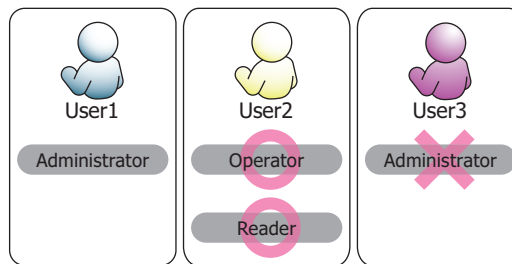

If you will not add a new security group, proceed to step **11**.

If you will not assign a security group, proceed to step **12**.

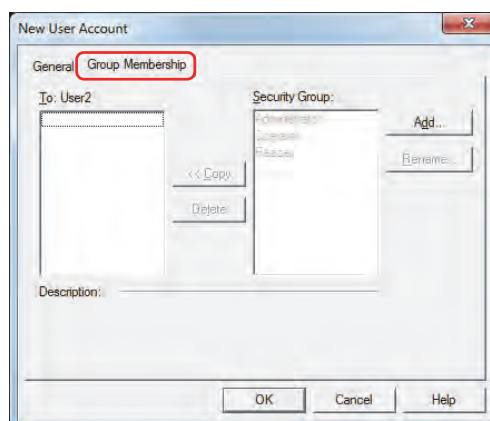

8 Click **Add**.

The New Security Group dialog box is displayed.

9 Enter the name of the new group in **New Group**, and then click **<< Add**.

The maximum number for the group name is 15 characters.

The created group name is added to **Security Group**. Repeat this procedure to create multiple security groups.



“なし” (Japanese), “None” (English), and “无” (Chinese) cannot be used for the group name.

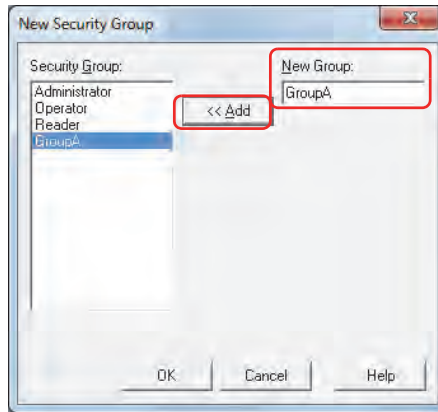

10 Click **OK**.

The group added is displayed in **Security Group**.

11 Select the security groups in **Security Group** on the New User Account dialog box to assign to the user being created, and then click **<< Copy**.

The security groups are copied to **To**.

The security groups that you create can be used in multiple user accounts.

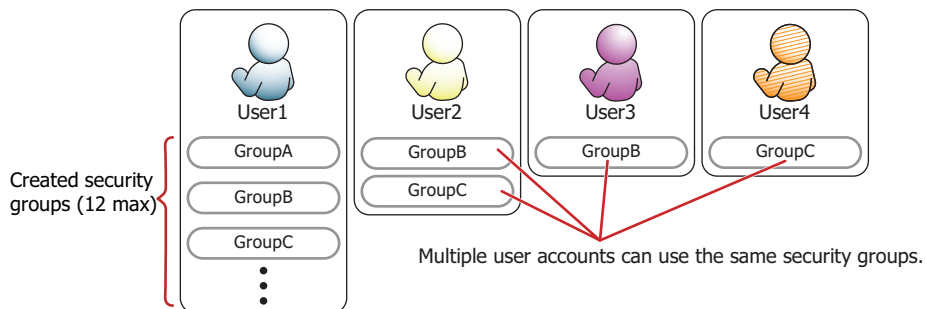

To delete the security groups assigned to the user, select the security groups to delete in **To**, and then click **Delete**.



- To select multiple security groups, press and hold SHIFT or CTRL while you click the specific items.
- Select the security groups in **Security Group**, and then click **Delete** to delete the security groups. However, security groups configured for user accounts, screens, and parts cannot be deleted.

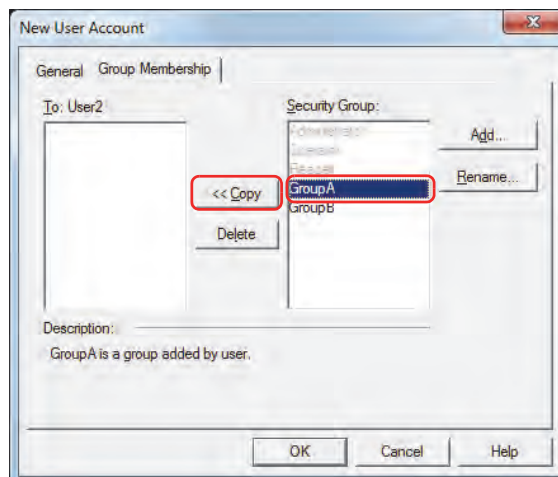

12 Click **OK**.

If you will not continue creating a user account, proceed to step **14**.

13 Repeat steps **3** through **12** and create all of the necessary user accounts.

You can configure a user account to be enabled when the Touch power is turned on and when switching the Run Mode in **Default User**.

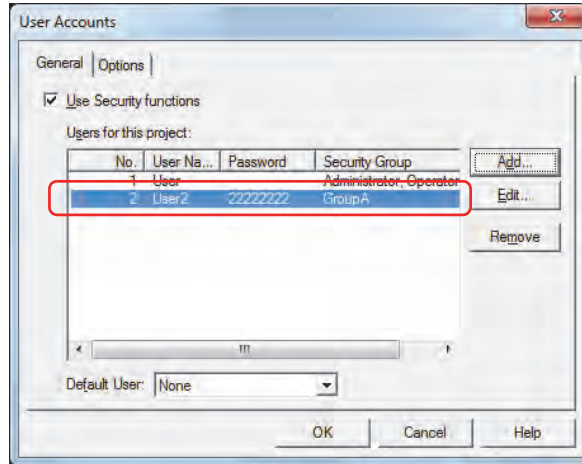
**14** Click **OK**.

The User Accounts dialog box closes.

This concludes creating a user account.

● Editing a User Account

- 1 On the **Configuration** tab, in the **Protect** group, click **User Accounts**.

The User Accounts dialog box is displayed.

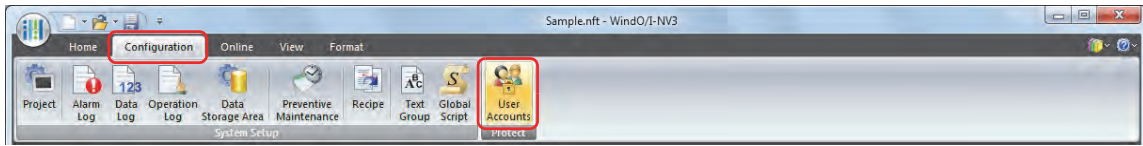

- 2 Select the user account to edit, and then click **Edit**.

The Change User Account dialog box is displayed.

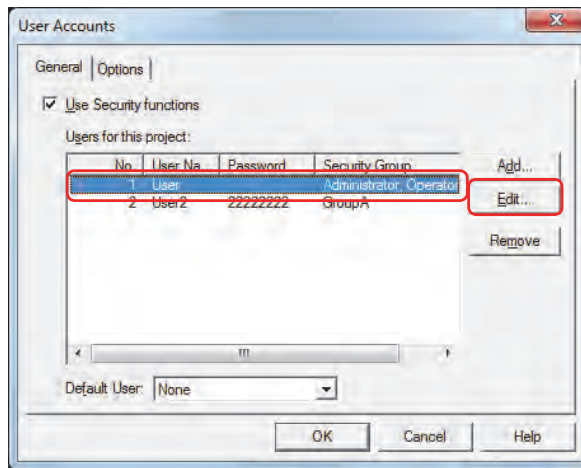

- 3 On the **General** tab, change **User Name** and **Password**.

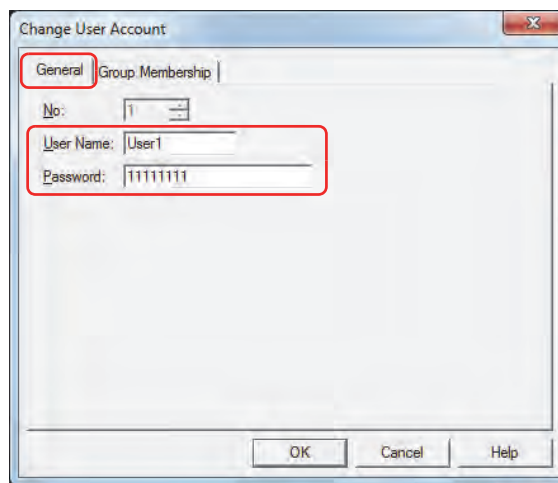

4 Click the **Group Membership** tab.

Change the security groups assigned to the user.

If you will not assign a security group or you will not delete a security group, proceed to step 7.

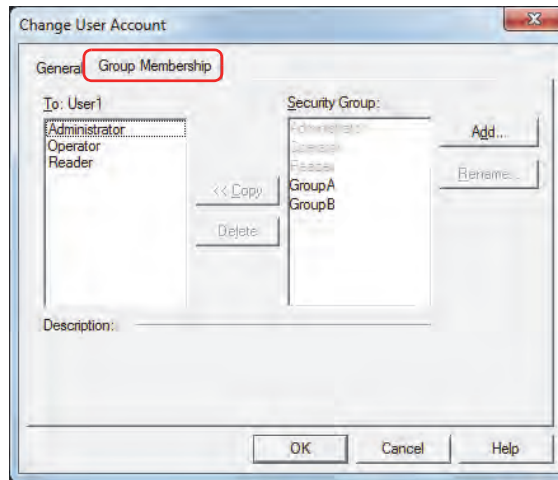

5 Select the security groups in **Security Group** to assign to the user being edited, and then click **<< Copy**.

The security groups are copied to **To**.

If you will not delete a security group, proceed to step 7.



To select multiple security groups, press and hold SHIFT or CTRL while you click the specific items.

6 Select the security groups assigned to the user to delete in **To**, and then click **Delete**.

The security groups are deleted from **To**.



- To select multiple security groups, press and hold SHIFT or CTRL while you click the specific items.
- Select the security groups in **Security Group**, and then click **Delete** to delete the security groups. However, security groups configured for user accounts, screens, and parts cannot be deleted.

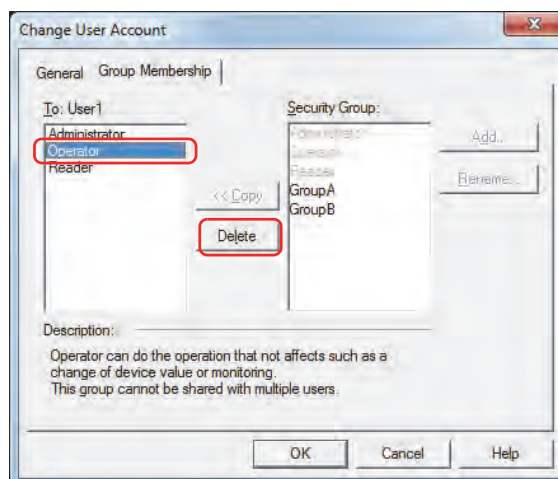

7 Click **OK**.

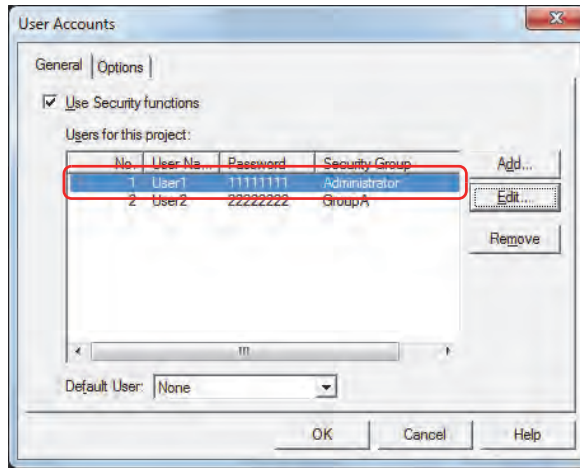

8 Click **OK** to close the User Accounts dialog box.
This concludes editing a user account.

● Deleting a User Account

1 On the **Configuration** tab, in the **Protect** group, click **User Accounts**.
The User Accounts dialog box is displayed.

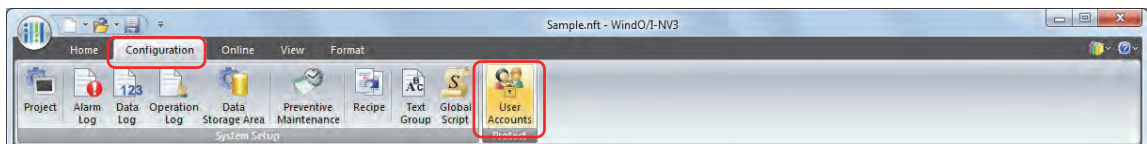

2 Select the user account to delete, and then click **Remove**.
The user account is deleted.

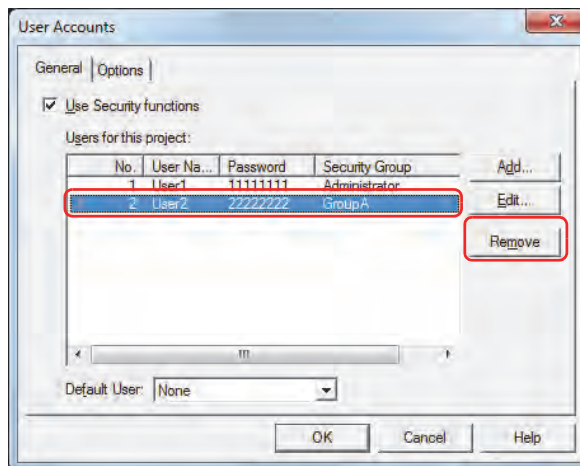

3 Click **OK**.
The User Accounts dialog box closes.
This concludes deleting a user account.

2.2 Adding and Editing Security Groups

● Adding a Security Group

- 1 On the **Project** window, double click **Security Group Settings**.

The Security Group Settings dialog box is displayed.

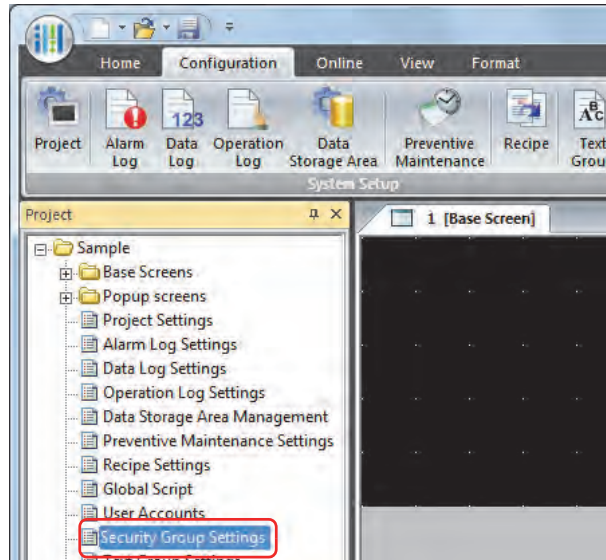

- 2 Enter the name of the new group in **New Group**, and then click **<< Add**.

The maximum number for the group name is 15 characters.

The created group name is added to **Security Group**. Repeat this procedure to create multiple security groups.



“なし” (Japanese), “None” (English), and “无” (Chinese) cannot be used for the group name.

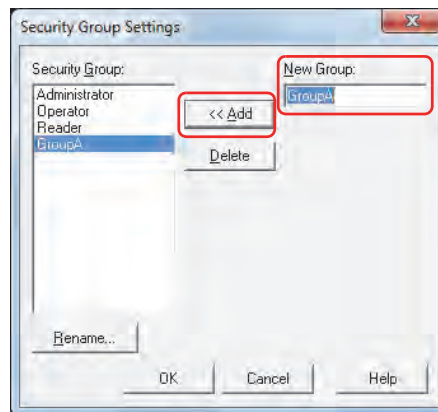

- 3 Click **OK**.

The Security Group Settings dialog box closes.

This concludes adding a security group.

● Changing the Name of a Security Group

- 1 On the **Project** window, double click **Security Group Settings**.

The Security Group Settings dialog box is displayed.

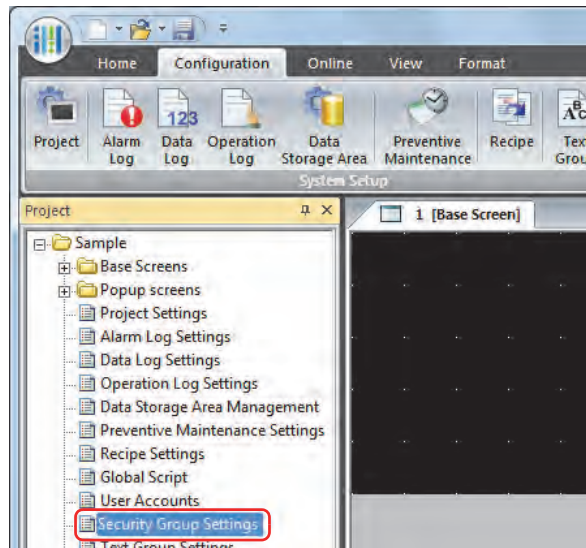

- 2 Select the security group in **Security Group** to change the name of, and then click **Rename**.

The Change Security Group Name dialog box is displayed.



The group name for Administrator, Operator, and Reader cannot be changed.

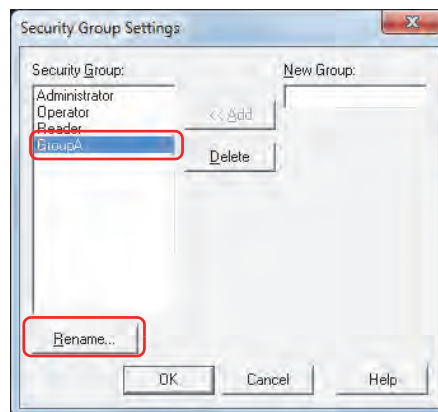

- 3 Change the name of the security group to the new group name in **New Name**.

The maximum number for the group name is 15 characters.



"なし" (Japanese), "None" (English), and "无" (Chinese) cannot be used for the group name.

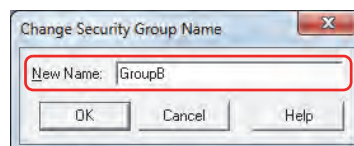

- 4 Click **OK**.

The Change Security Group Name dialog box closes.

- 5 Click **OK**.

The Security Group Settings dialog box closes.

This concludes changing the name of a security group.

● Deleting a Security Group

- 1 On the **Project** window, double click **Security Group Settings**.

The Security Group Settings dialog box is displayed.

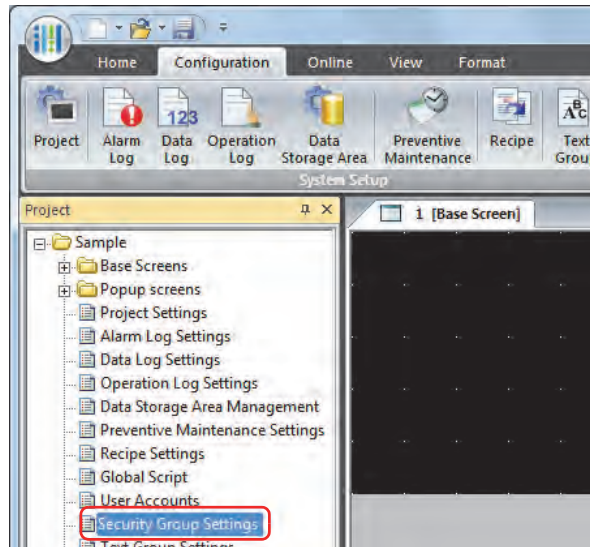

- 2 Select the security group in **Security Group** to delete, and then click **Delete**.

The security group is deleted.



To select multiple security groups, press and hold SHIFT or CTRL while you click the specific items.

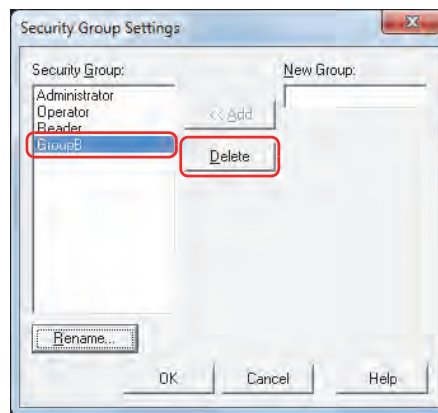

- Security groups configured for user accounts, screens, and parts cannot be deleted.
- Administrator, Operator, and Reader cannot be deleted.

- 3 Click **OK**.

The Security Group Settings dialog box closes.

This concludes deleting a security group.

2.3 Protecting the Display and Operation of Screens and Parts

● Protecting the Display of Screens

Here you will configure the security group for a screen to protect the display of that screen.

This section describes an example where the display of Base Screen 2 is protected when switching to Base Screen 2 by pressing the Goto Screen Button.

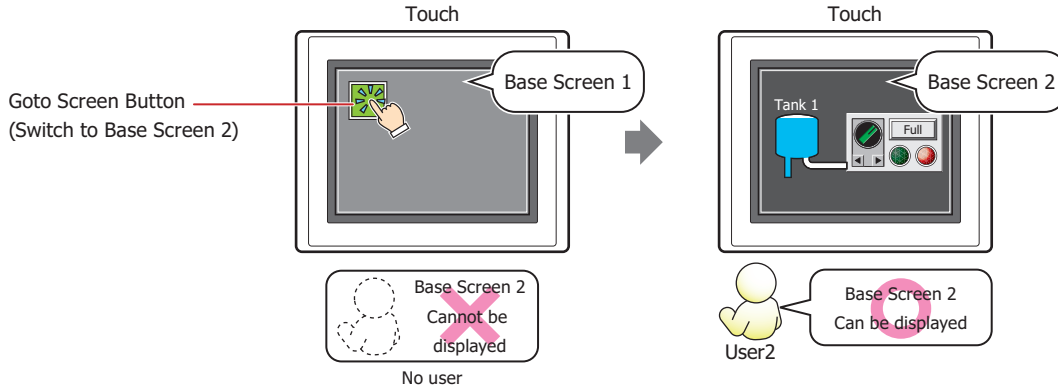

To change the user account, a button or command is required to open the Password screen.

Configuration Procedure

- 1 Following the procedure in "Creating a User Account" on page 21-8, create the following user account.

User Name	 User2
Security Group	GroupA

To automatically display the Password screen when the user attempts to switch to a Base Screen they cannot access with the current user account using the Goto Screen Button, in the User Accounts dialog box, in the **Options** tab, select the **Require a password automatically** check box. For displaying the Password screen, refer to "4.1 Entering the Password on the Touch" on page 21-36.

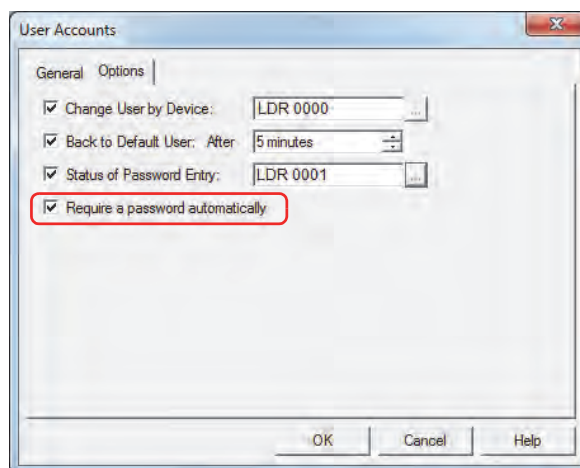

- 2 Place a Goto Screen Button on Base Screen 1.
On the **Home** tab, in the **Parts** group, click **Buttons**, and then click **Goto Screen Button**.

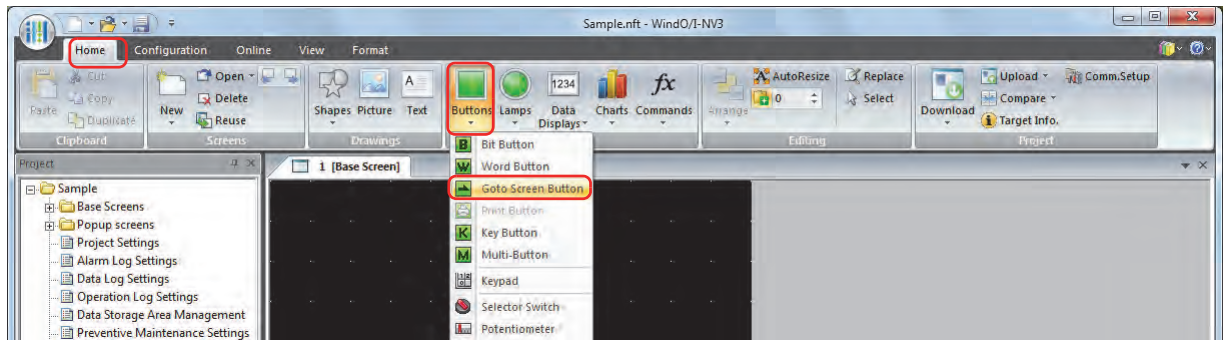

- 3 Click a point on the edit screen where you want to place the Goto Screen Button.
- 4 Double-click the dropped Goto Screen Button and the Properties dialog box is displayed.

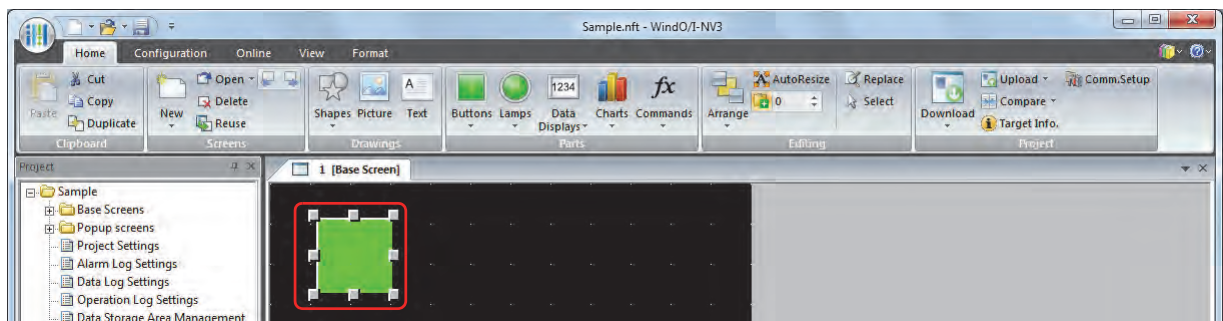

- 5 Select **Switch to Base Screen** for **Action Mode**.

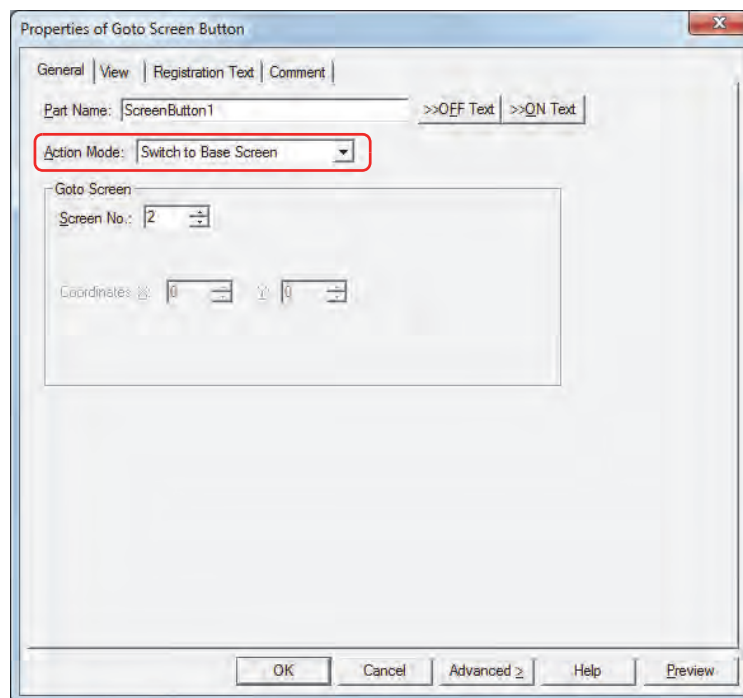

- 6 Specify the screen number of the Base Screen to switch to with **Screen No.** under **Goto Screen**.
2 is specified here.
- 7 Click **OK**.
The Properties of Goto Screen Button dialog box closes.

- 8 Create the Base Screen to switch to and configure the security group.
On the **Home** tab, in the **Screens** group, click the arrow under **New**, and then click **Base Screen**.
The Screen Properties dialog box is displayed.

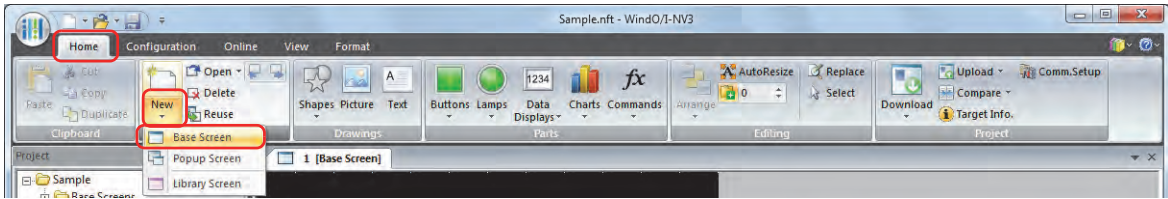

- 9 Specify the screen number of the Base Screen to switch to with **No.** on the **General** tab.
This is the same screen number as the screen number specified in step 6. 2 is specified here.

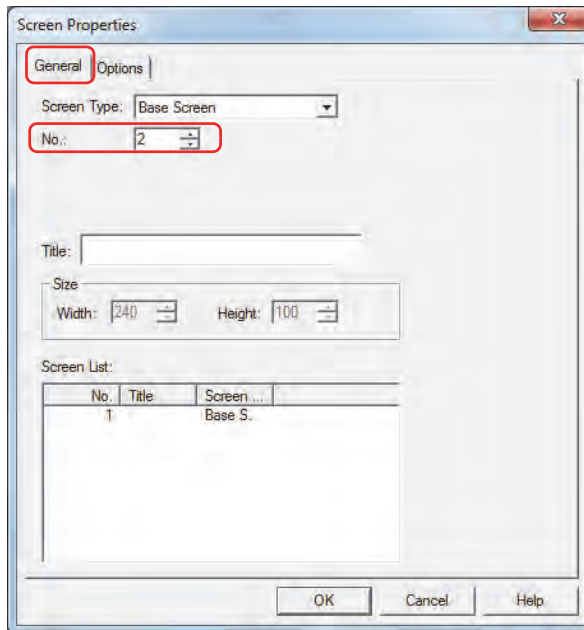

- 10 Click the **Options** tab.

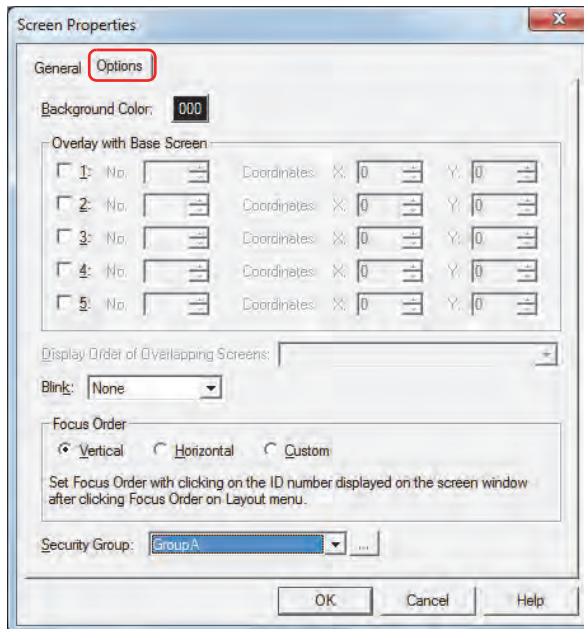

- 11 With **Security Group**, select the security group to allow the display of the Base Screen.
Group A is selected here.
- 12 Configure the settings on each tab as necessary, and then click **OK**.
The Screen Properties dialog box closes.
This concludes configuring the project to protect the display of screens.

Operating Procedure

This section describes an example when the current user account has no default user.

- 1 Press the Goto Screen Button configured with **Switch to Base Screen**.

The Password screen is displayed.

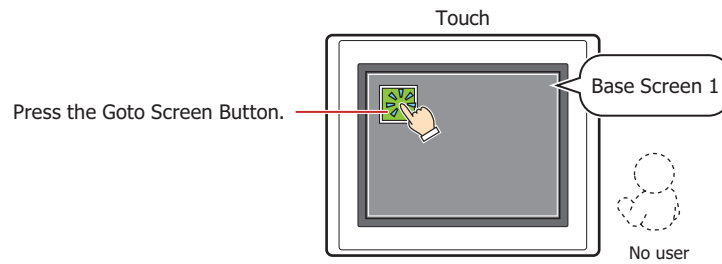

- 2 Press ▼ and select **User2**.

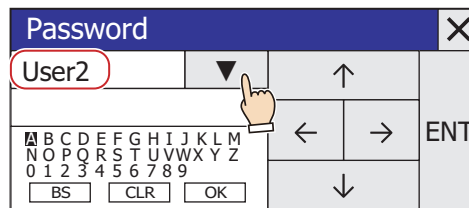

- 3 Enter the password.

1. Press ↑, ↓, ←, and → to move the cursor to the character selected and then press **ENT**.

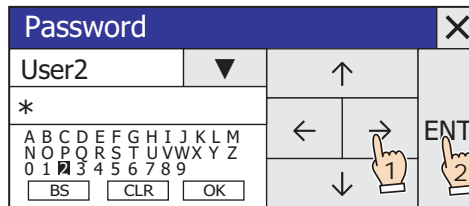

2. Repeat 1 to enter all the characters for the password.
3. Press ↑, ↓, ←, and → to move the cursor to **OK** and then press **ENT**.

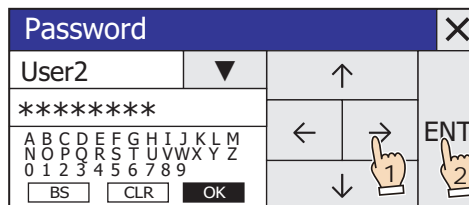

If the correct password is entered, the user account changes to **User2** and the Password screen closes. Base Screen 2 is displayed.

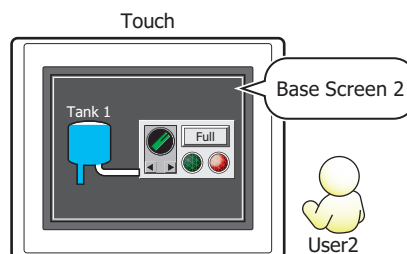

● Protecting the Display of Parts

Here you will configure the security group for a part to protect the display of that part. This section describes an example where the display of the Line Chart is protected.

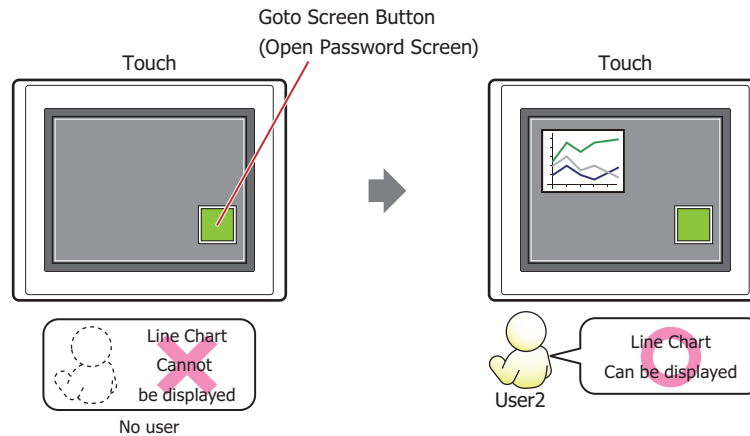

To change the user account, a button or command is required to open the Password screen.

Configuration Procedure

- 1 Following the procedure in "Creating a User Account" on page 21-8, create the following user account.

User Name	 User2
Security Group	GroupA

- 2 Create a Line Chart and configure the display security group. On the **Home** tab, in the **Parts** group, click **Charts**, and then click **Line Chart**.

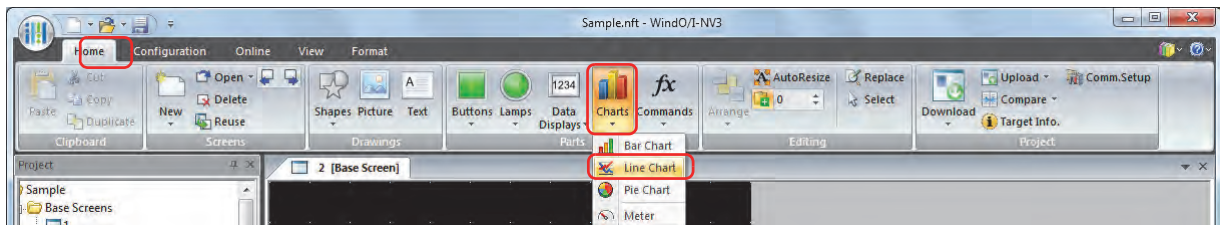

- 3 Click a point on the edit screen where you want to place the Line Chart.
- 4 Double-click the dropped Line Chart and the Properties dialog box is displayed.

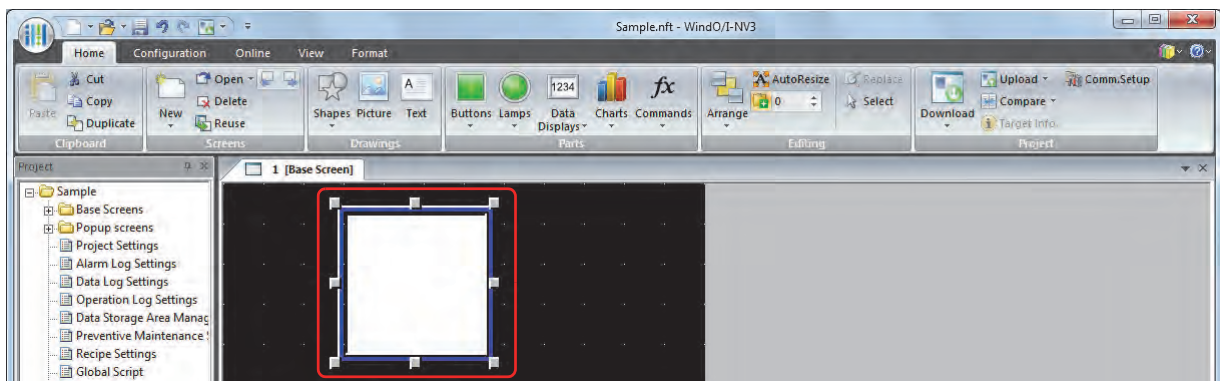

5 Click **Advanced**.

The **Options** tab is displayed.

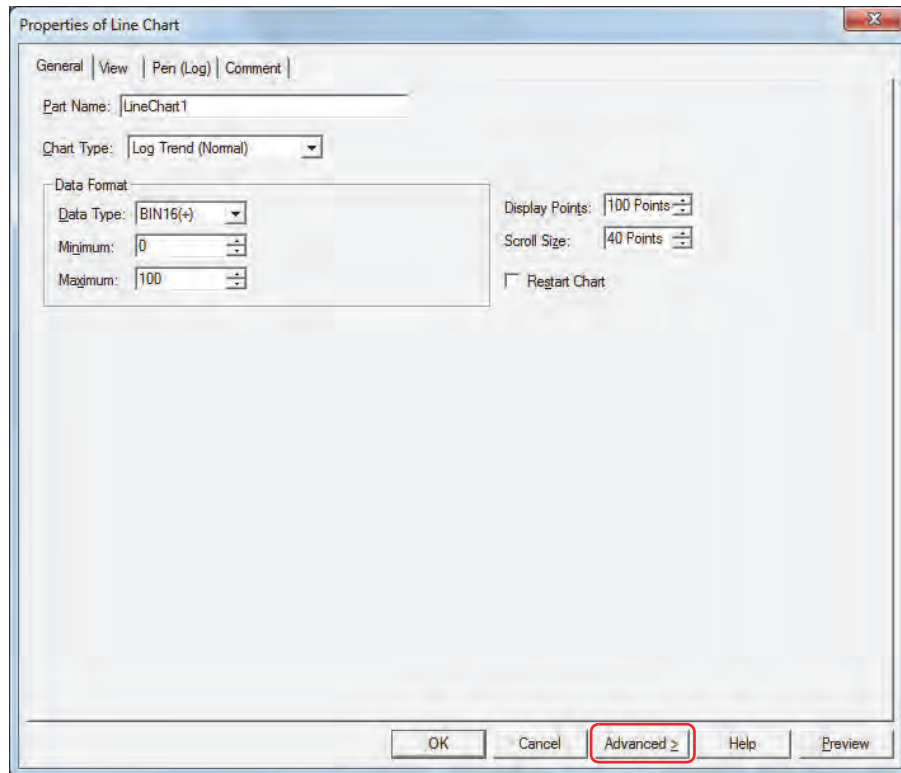

6 Click the **Options** tab.

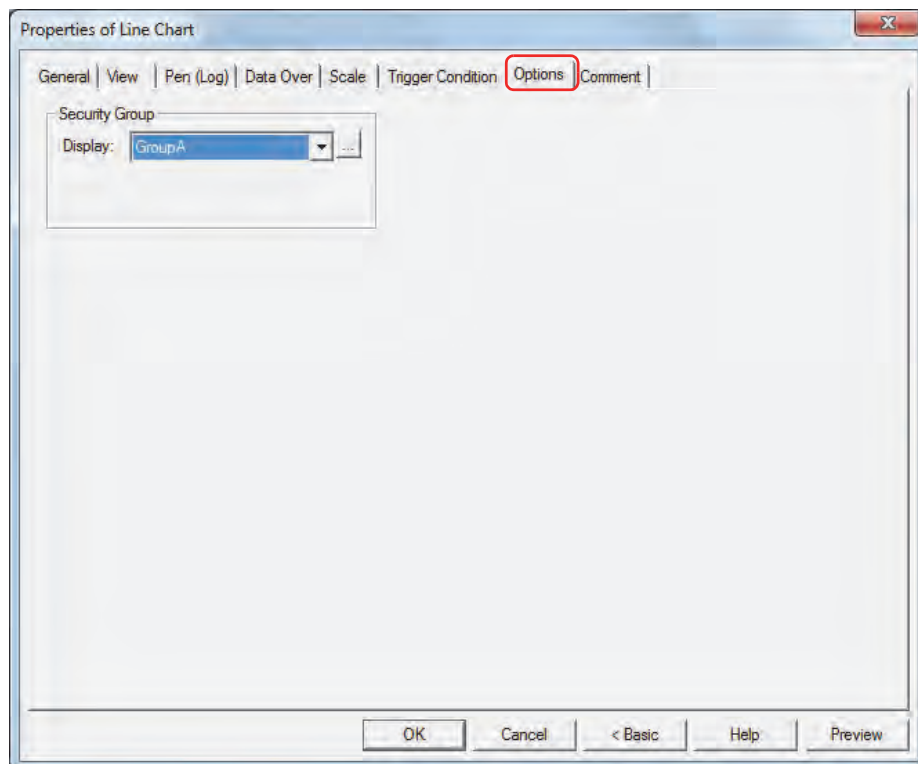

7 Select the security group to allow the display of the Line Chart with **Display** under **Security Group**.

GroupA is selected here.

8 Configure the settings on each tab as necessary, and then click **OK**.

The Properties of Line Chart dialog box closes.

- 9 Place a Goto Screen Button to display the password screen on the Base Screen.
On the **Home** tab, in the **Parts** group, click **Buttons**, and then click **Goto Screen Button**.

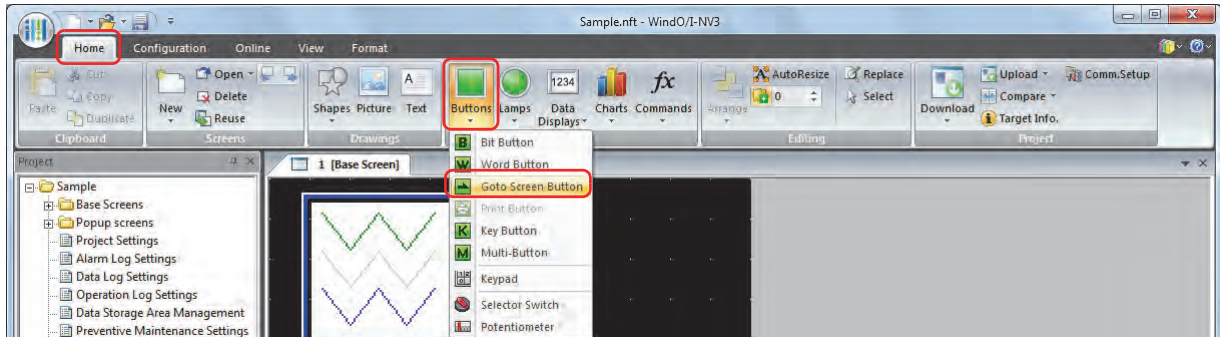

- 10 Click a point on the edit screen where you want to place the Goto Screen Button.
- 11 Double-click the dropped Goto Screen Button and the Properties dialog box is displayed.

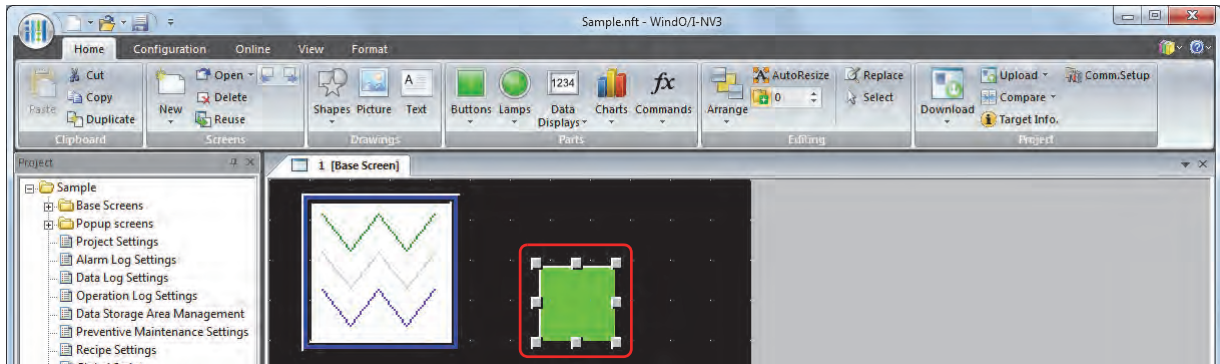

- 12 Select **Open Password Screen** for **Action Mode**.

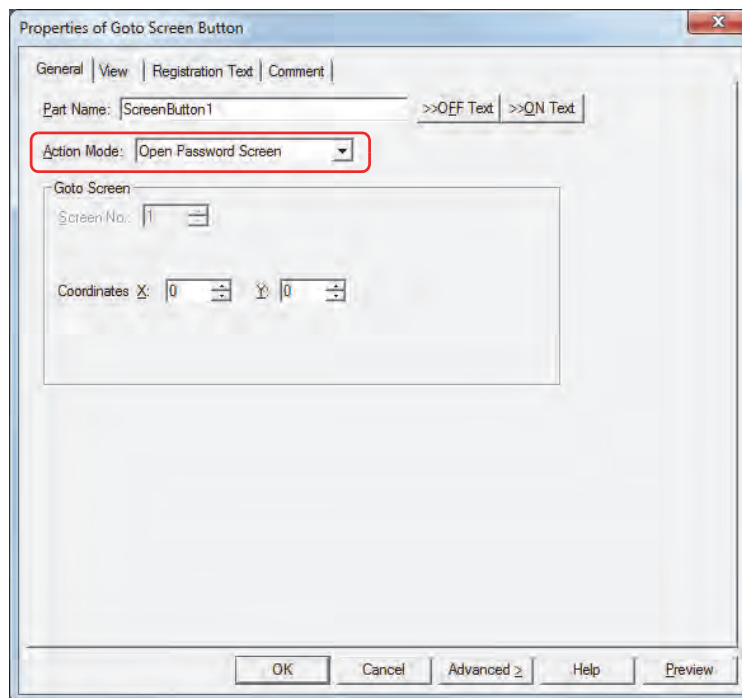

- 13 Specify the display location in coordinates for the password screen to open above the Base Screen with **Coordinates X, Y**.
With the upper-left corner of the screen as the origin, the upper-left corner of the window is the X and Y coordinates.
X: 0 to (Base Screen horizontal size - 1)
Y: 0 to (Base Screen vertical size - 1)

14 Click **OK**.

The Properties of Goto Screen Button dialog box closes.

This concludes configuring the project to protect the display of a part.

Operating Procedure

This section describes an example when the current user account has no default user.

1 Press the Goto Screen Button configured with **Open Password Screen**.

The Password screen is displayed.

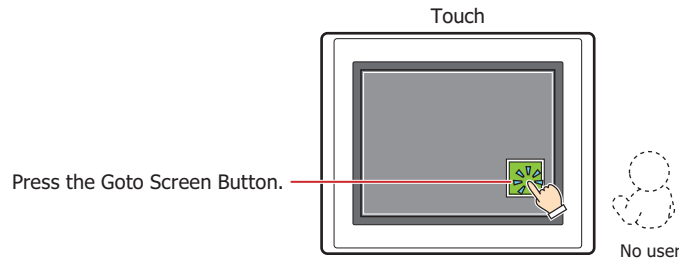
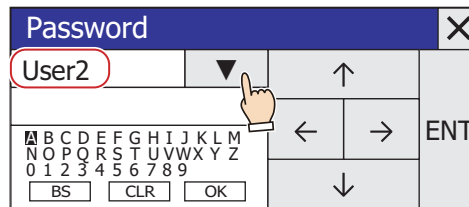
**2** Press **▼** and select **User2**.**3** Enter the password.

1. Press **↑**, **↓**, **←**, and **→** to move the cursor to the character selected and then press **ENT**.

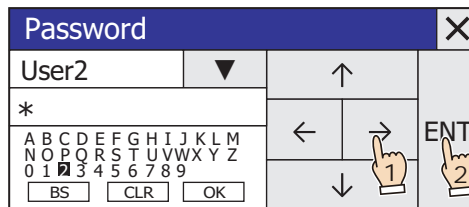

2. Repeat 1 to enter all the characters for the password.

3. Press **↑**, **↓**, **←**, and **→** to move the cursor to **OK** and then press **ENT**.

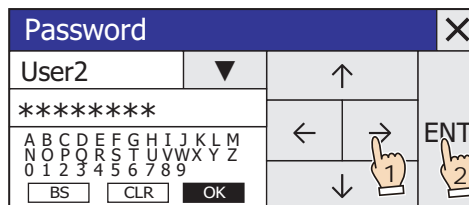

If the correct password is entered, the user account changes to **User2** from no default user and the Password screen closes.

The Line Chart is displayed.

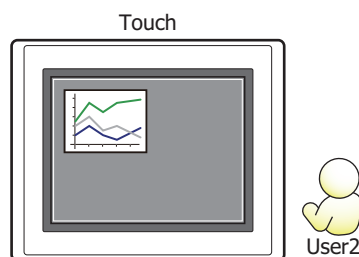

● Protecting the Operation of Parts

Here you will configure the security group for a part to protect the operation of that part. This section describes an example where the operation of the Numerical Input is protected.

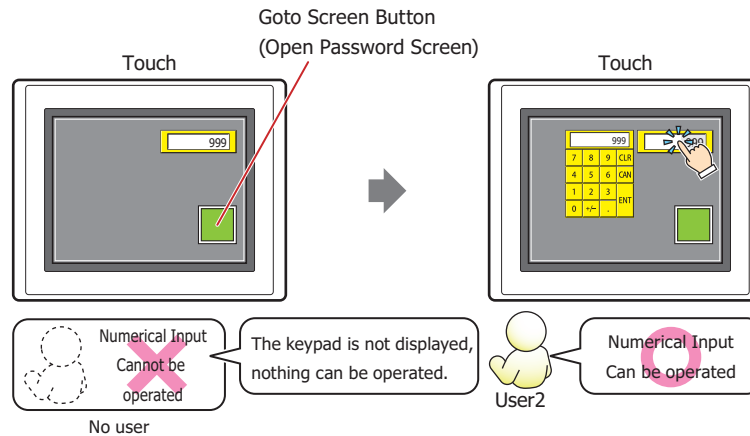

To change the user account, a button or command is required to open the Password screen.

Configuration Procedure

- 1 Following the procedure in "Creating a User Account" on page 21-8, create the following user account.

User Name	 User2
Security Group	GroupA

- 2 Create a Numerical Input and configure the input security group. On the **Home** tab, in the **Parts** group, click **Data Displays**, and then click **Numerical Input**.

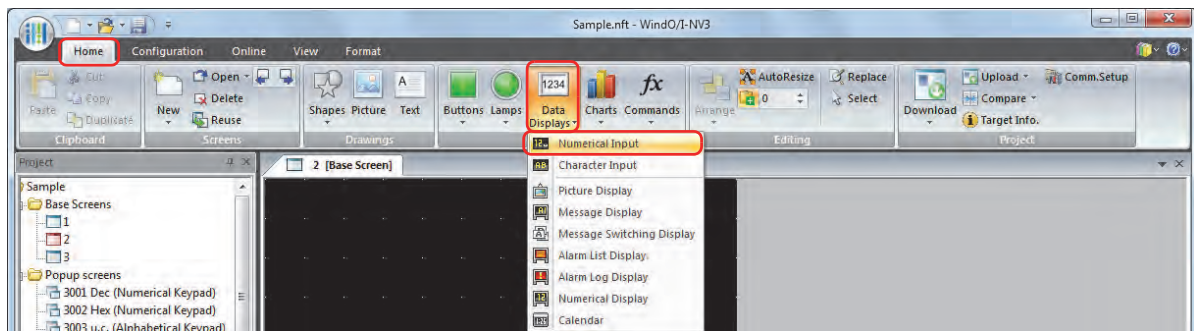

- 3 Click a point on the edit screen where you want to place the Numerical Input.
- 4 Double-click the dropped Numerical Input and the Properties dialog box is displayed.

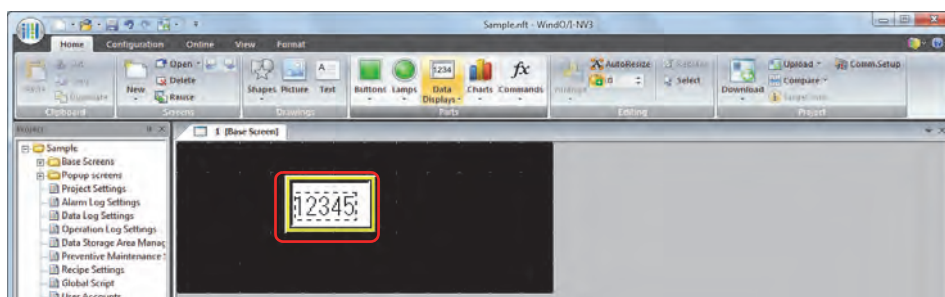

5 Click **Advanced**.

The **Options** tab is displayed.

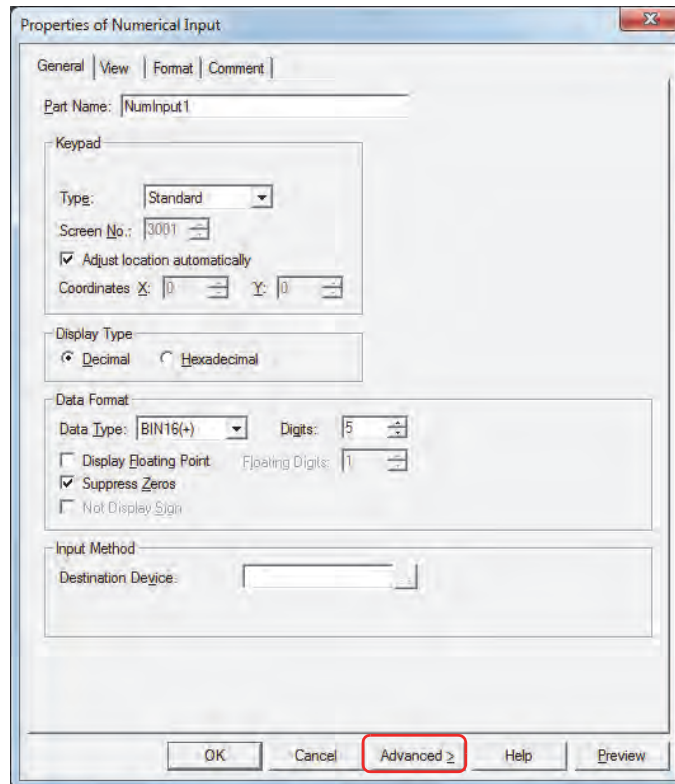
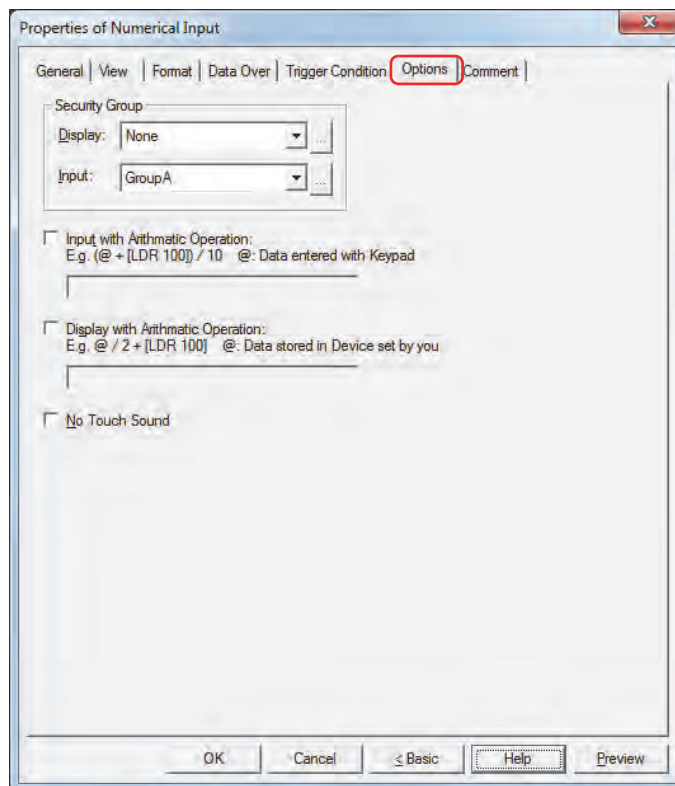
6 Click the **Options** tab.7 Select the security group to allow the operation of the Numerical Input with **Input** under **Security Group**. **GroupA** is selected here.8 Configure the settings on each tab as necessary, and then click **OK**.

The Properties of Numerical Input dialog box closes.

- 9 Place a Goto Screen Button to display the password screen on the Base Screen.
On the **Home** tab, in the **Parts** group, click **Buttons**, and then click **Goto Screen Button**.

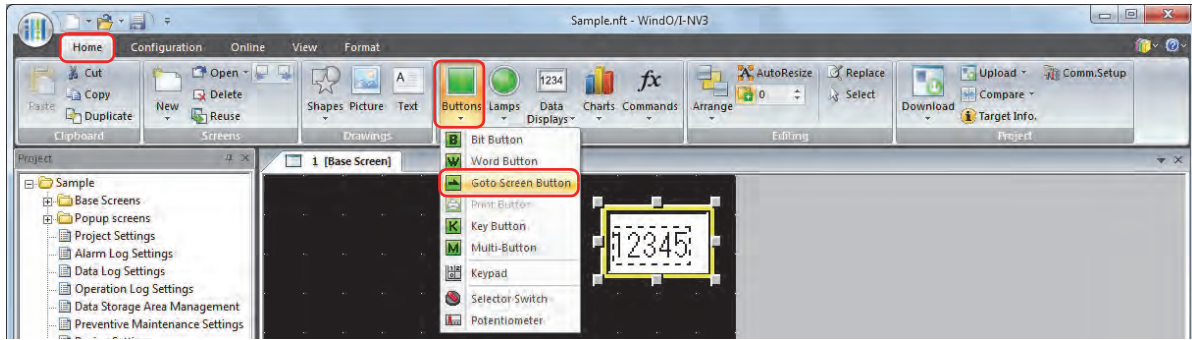

- 10 Click a point on the edit screen where you want to place the Goto Screen Button.
- 11 Double-click the dropped Goto Screen Button and the Properties dialog box is displayed.

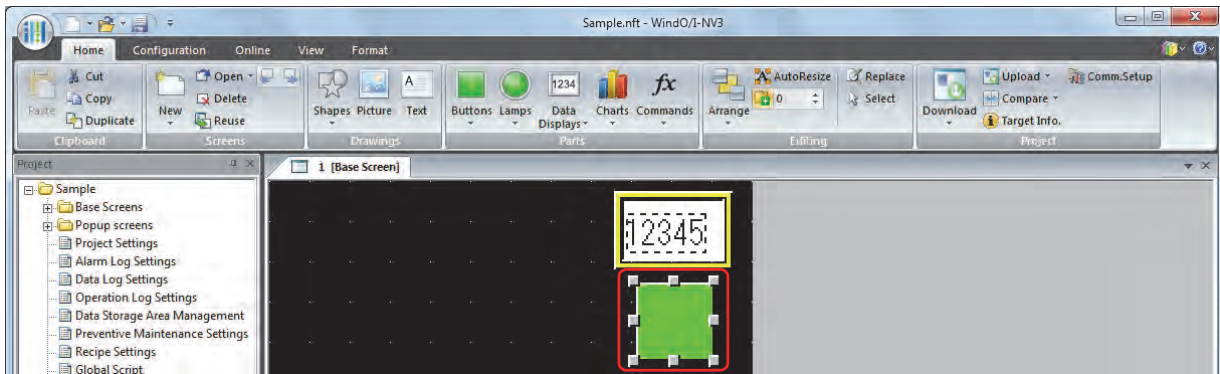

- 12 Select **Open Password Screen** for **Action Mode**.

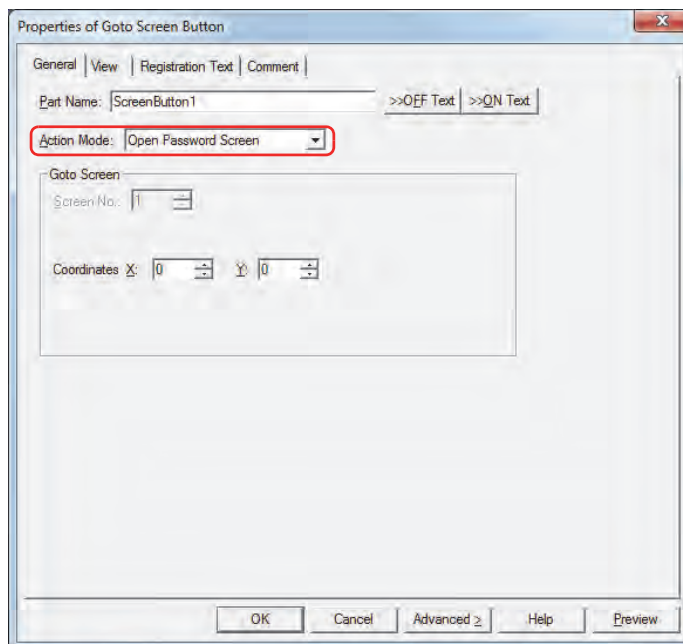

- 13 Specify the display location in coordinates for the password screen to open above the Base Screen with **Coordinates X, Y**.
With the upper-left corner of the screen as the origin, the upper-left corner of the window is the X and Y coordinates.
X: 0 to (Base Screen horizontal size - 1)
Y: 0 to (Base Screen vertical size - 1)

14 Click **OK**.

The Properties of Goto Screen Button dialog box closes.

This concludes configuring the project to protect the operation of a part.

Operating Procedure

This section describes an example when the current user account has no default user.

1 Press the Goto Screen Button configured with **Open Password Screen**.

The Password screen is displayed.

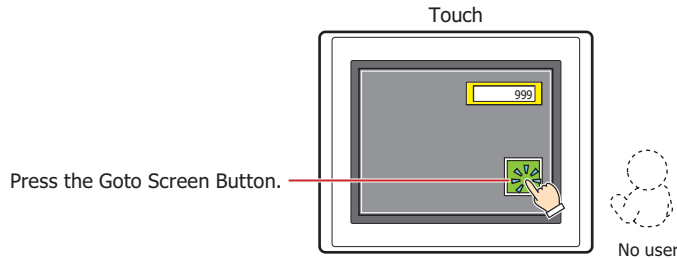

2 Press ▼ and select **User2**.

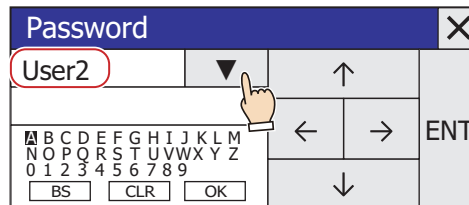

3 Enter the password.

1. Press ↑, ↓, ←, and → to move the cursor to the character selected and then press **ENT**.

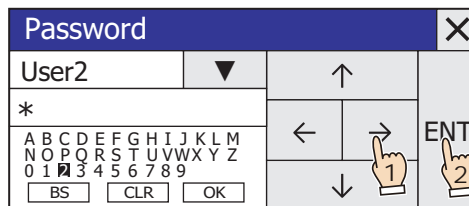

2. Repeat 1 to enter all the characters for the password.

3. Press ↑, ↓, ←, and → to move the cursor to **OK** and then press **ENT**.

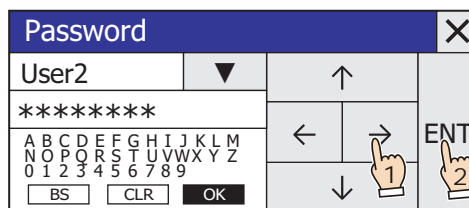

If the correct password is entered, the user account changes to **User2** from no default user and the Password screen closes.

The Numerical Input can be operated.

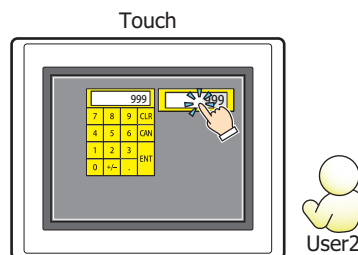

3 User Accounts Dialog Box

This section describes items and buttons on the User Accounts dialog box.

3.1 User Accounts Dialog Box

The passwords and security groups assigned to user accounts are collectively managed in the User Accounts dialog box.

● General Tab

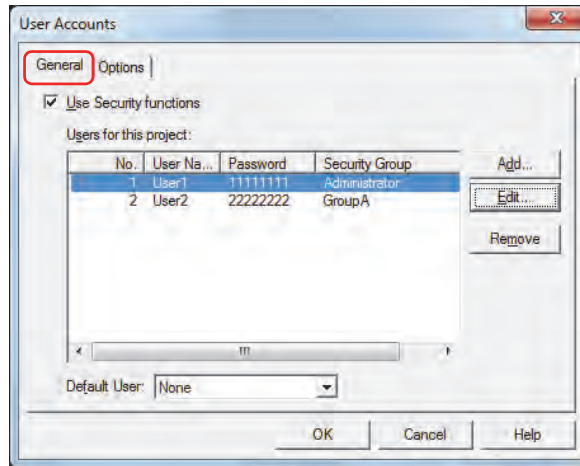

■ Use Security functions

Select this check box to protect access to data and to protect Touch displays and operations by accounts. The settings related to user accounts are displayed.

When this check box is cleared, switching to System Mode, displaying the monitor, and accessing data are protected by a single password. The SmartAXIS Touch is not protected if **Password** is left blank.

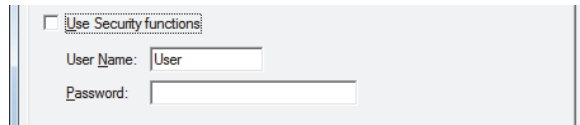

User Name: Enter the name for the user account.

The maximum number for the user name is eight characters. Only alphanumeric characters and symbols can be used.



You cannot use the following characters in the user name.

\ / : * ? " < > |

Password: Enter the password.

The number of characters for the password is 4 to 15. Only uppercase alphabetic characters and numbers can be used.



Write down the password so you do not forget it and save that note in a safe place.

■ Users for this project

No.:	Displays the number (1 to 15) used when switching the user account according to the value of device. Double clicking the cell displays the Change User Account dialog box. For details, refer to "New User Account Dialog Box and Change User Account Dialog Box" on page 21-32.
User Name:	Displays the name for the user account. Double clicking the cell displays the Change User Account dialog box. For details, refer to "New User Account Dialog Box and Change User Account Dialog Box" on page 21-32.
Password:	Displays the password for the user account. Double clicking the cell displays the Change User Account dialog box. For details, refer to "New User Account Dialog Box and Change User Account Dialog Box" on page 21-32.
Security Group:	Displays all of the security groups for user accounts. Double clicking the cell displays the Change User Account dialog box. For details, refer to "New User Account Dialog Box and Change User Account Dialog Box" on page 21-32.

■ Add

Makes a new user account. You can create a maximum of 15. Click this button to display the New User Account dialog box. In the New User Account dialog box, the user name, password, and security groups are assigned to the user account. For details, refer to "New User Account Dialog Box and Change User Account Dialog Box" on page 21-32.

■ Edit

Select a number in **Users for this project**, and then click this button to display the Change User Account dialog box. In the Change User Account dialog box, the user name, password, and security groups are changed. For details, refer to "New User Account Dialog Box and Change User Account Dialog Box" on page 21-32.

■ Remove

Deletes the user account with the selected number. Select a number, and then click this button.

■ Default User

Select the user account to be enabled when the Touch power is turned on and when switching the Run Mode. If **None** is selected, no user account is selected when the Touch power is turned on and when the Run Mode is changed. Screens and parts cannot be displayed or operated that are protected by a security group.

New User Account Dialog Box and Change User Account Dialog Box

In the New User Account dialog box, the user name, password, and security groups are assigned to an account and that user account is added.

In the Change User Account dialog box, the user name, password, and security groups for the selected user account are changed.

General Tab

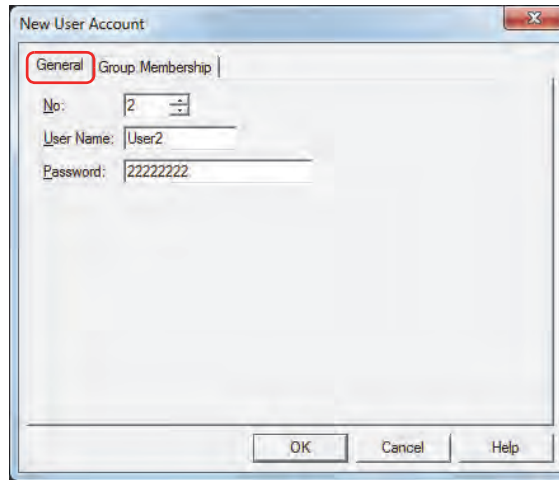

■ No.

In the New User Account dialog box, this setting specifies the number (1 to 15) when switching the account according to the value of device.

When **Edit** was clicked and the Change User Account dialog box was displayed, this item displays the selected user account number.

■ User Name

Enter the name for the user account.

The maximum number is eight characters. Only alphanumeric characters and symbols can be used.



You cannot use the following characters in the user name.

\ / : * ? " < > |

■ Password

Enter the password.

The number of characters for the password is 4 to 15. Only uppercase alphabetic characters and numbers can be used.



Write down the password so you do not forget it and save that note in a safe place.

Group Membership Tab

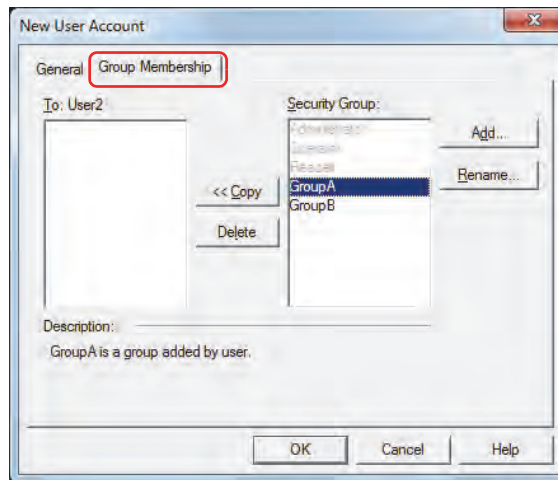

- **To: (user name being configured)**
Displays the user name and the list of security groups assigned to the user.
- **<< Copy**
Assigns the security groups to the user displayed in **To**.
Select the security groups in **Security Group**, and then click this button to add them to **To**.
- **Delete**
Deletes the security groups assigned to the user.
Select the security groups in **To**, and then click this button.
- **Security Group**
Displays a list of all the security groups. The provided security groups (Administrator, Operator, and Reader) are grayed out if assigned to another user account.
- **Add**
Makes a new security group. You can create a maximum of 12.
Click this button to display the New Security Group dialog box. New security groups are added in the New Security Group dialog box. For details, refer to "Adding a Security Group" on page 21-15.
- **Rename**
Select a security group in **Security Group**, and then click this button to display the Change Security Group Name dialog box. Change the name of the security group in the Change Security Group Name dialog box. For details, refer to "Changing the Name of a Security Group" on page 21-16.

● **Options Tab**

These settings can only be configured when the **Use Security functions** check box is selected on the **General** tab.

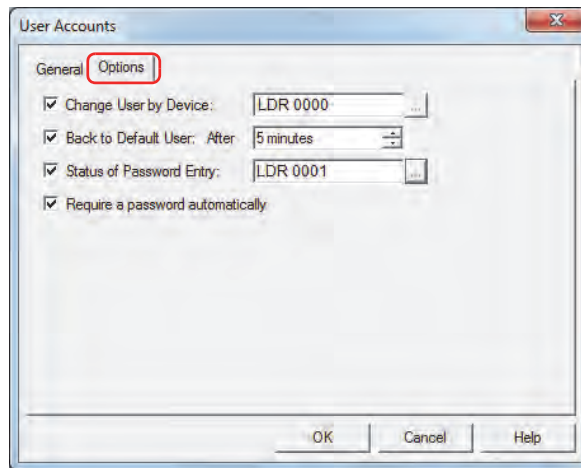

■ **Change User by Device**

Select this check box to switch the user account according to the value of device.

The user account is specified by using the number on the **General** tab.

(Trigger device): Specifies the word device to write the number.

Click to display the Device Address Settings dialog box. For the device address configuration procedure, refer to Chapter 2 "5.1 Device Address Settings" on page 2-61.

Example: When the trigger device is D0 and the default user is selected as User1

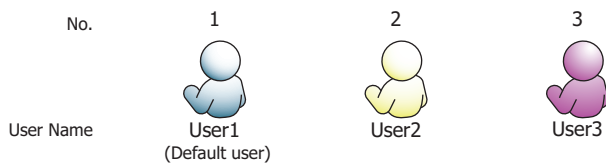

The user account switches according to the value of device.

Value of Trigger device D0	1	2	3	4	0
User account	 User1	 User2	 User3	 User3	 User1
Action	Switch to user account no. 1	Switch to user account no. 2	Switch to user account no. 3	None	Switch to default user account

The user account is not switched when the value of device is a number not configured to a user account or an invalid number.

If the value of device is 0, the user is switched to the default user.

■ **Back to Default User**

Select this check box to automatically switch to the default user when the Touch is unused for an extended period of time.

After: Specify the time (0 to 60 minutes) to switch to the default user after the Touch is last used.

If 0 is set, the Touch switches back to the default user immediately, even if the user account was changed.

■ Status of Password Entry

Select this check box to monitor the entry status of the password on the Password screen.

(Destination device): Specifies a word device to write the password entry status.

Click  to display the Device Address Settings dialog box. For the device address configuration procedure, refer to Chapter 2 "5.1 Device Address Settings" on page 2-61.

The following bits change to 1 depending on the password input status. These bits become 0 when the Password screen opens or when a button other than **ENT** or  (Close) is pressed on the Password screen.

Bit position	Function	Parameters
0	This bit stores the information when the correct password was entered on the Password screen and ENT was pressed.	0: Password being entered 1: Correct password entered
1	This bit stores the information when an incorrect password was entered on the Password screen and ENT was pressed.	0: Password being entered 1: Incorrect password entered
2	This bit stores the information when  (Close) was pressed on the Password screen.	0: Password being entered 1: Password entry canceled
3 to 7	Reserved	-

■ Require a password automatically

Select this check box to automatically display the Password screen when the user attempts to switch to a Base Screen that cannot be accessed with the current user account by using a Goto Screen Button or Goto Screen Command configured with **Switch to Base Screen** for the **Action Mode** in the Properties dialog box.

4 Password Input

When a password is configured for a user account, the user is prompted to enter their password with the following operations.

- Accessing password protected data
- Executing password protected displays and operations

4.1 Entering the Password on the Touch

To execute password protected operations, the user must open the Password screen and switch the user account. The Password screen is opened with a Goto Screen Button or Goto Screen Command configured with Password Screen. The Password screen is also automatically displayed on the Touch when the following operations are executed.

- Switching to a Base Screen for a security group that cannot be displayed by the current user account with the Goto Screen Button, Multi-Button, Goto Screen Command, or Multi-Command when the **Require a password automatically** check box is selected on the **Options** tab in the User Accounts dialog box
- Switching to Top Page in the System Mode or displaying the Device Monitor with the Maintenance screen, Goto Screen Button, Multi-Button, Goto Screen Command, or Multi-Command
- Downloading or uploading project data with a Key Button, Multi-Button, or Multi-Command
- Executing the USB Autorun function



- Operations where the Password screen is not displayed are as follows.
 - Switching the Base Screen using the System Area
 - Displaying the alarm screen for the Alarm Log Settings
 - Opening the keypad with the Numerical Input or Character Input
 - Opening the Ref. screen with the Alarm Log Display
 - For screens that are already open when the user account was switched by opening the Password screen with the Goto Screen Button or Goto Screen Command
- When the user account is switched, the displayed Base Screen is reset. Popup screens and internal devices have the same behavior as when the Base Screen is switched. However, if the **Close while changing Base Screen** check box is selected on the **Options** tab in the Properties dialog box for the popup screen, the popup screen is closed when the Base Screen is switched. The behavior of the internal devices varies based on the internal devices. For details, refer to Chapter 27 "Internal Devices" on page 27-1.
- When the Touch has been installed vertically, the password screen is displayed horizontally.

● Password Screen Configuration

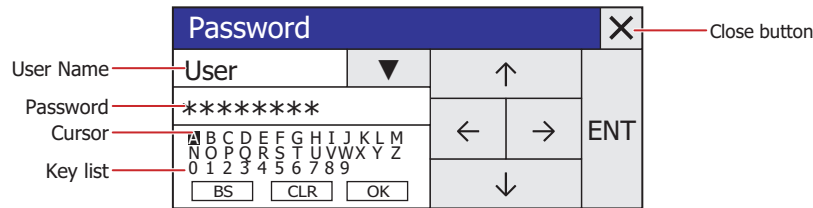

■ User Name

Displays the selected user name.

■ ▼

Switches the user name. Changes the user name in order of user account number. When the last user name is changed, it returns to the first user name.

■ Password

The entered password is displayed as "*".

■ Key list

Cursor Highlights the selected character or command.

A to Z, 0 to 9: The available characters which can be used in the **Password**. Select with the cursor and press **ENT** to enter the selected character in **Password**.

BS: Select with the cursor and press **ENT** to delete one character entered in **Password**.

CLR: Select with the cursor and press **ENT** to delete all the characters entered in **Password**.

OK: Select with the cursor and press **ENT** to confirm the entered password and start verifying the user name and password.

If the entered password is correct, the Password screen closes and the operation executes.

If the entered password was incorrect, the password entered on the Password screen is deleted and the screen returns to input mode.

■ ↑

Moves the character list cursor up.

■ ←

Moves the character list cursor left.

■ →

Moves the character list cursor right.

■ ↓

Moves the character list cursor down.

■ ENT

Enters the selected character in **Password** or executes the selected command.

■ X (Close) button

Cancels password entry and closes the Password screen.

4.2 Entering the Password in WindO/I-NV3

When a user account assigned with Administrator is configured with a password, the Enter Password dialog box is displayed in WindO/I-NV3 as required and the user is prompted to enter their password.

The operations that display the Enter Password dialog box are as follows.

- Opening projects
- Reusing screens
- Downloading project data
- Downloading data to external memory^{*1}
- Downloading data to external memory^{*1} while the Touch is running
- Uploading project data
- Uploading external memory data^{*1}
- Deleting all data
- Deleting external memory data^{*1}
- Formatting external memory^{*1}

● Enter Password Dialog Box

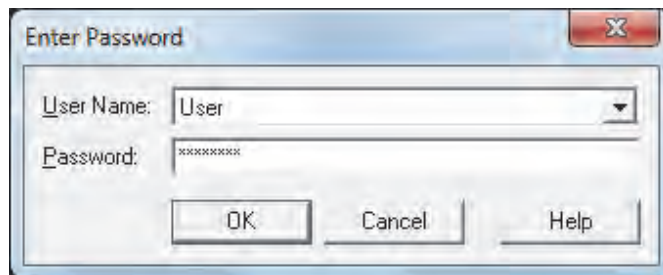

■ User Name

Selects the user name. This item can only be selected when multiple user accounts are registered.

■ Password

Enter the password. The entered password is displayed as "*".

■ OK

Confirms the entered password and starts verifying the user name and password.

If the entered password is correct, the Enter Password dialog box closes and the operation executes.

If the entered password is incorrect, a confirmation message is displayed.

■ Cancel

Cancels password input and closes the Enter Password dialog box.

*1 External memory inserted into the Touch

Chapter 22 Communication

This chapter describes the communication between the Touch and the external device.

1 PLC Link Communication

1.1 Overview

PLC Link Communication refers to the communication protocol used for communication with the Touch, via the CPU Unit*¹ or PLC Link Unit*¹ Programming Port of the external device connected to the Touch.

The Touch continuously reads the value of device of external devices on the currently displayed screen, and external devices (such as relays and registers) on the screens are updated with the latest data at all times.

When a button is pressed or a command is executed in the Touch screen, the value is written to the external device.

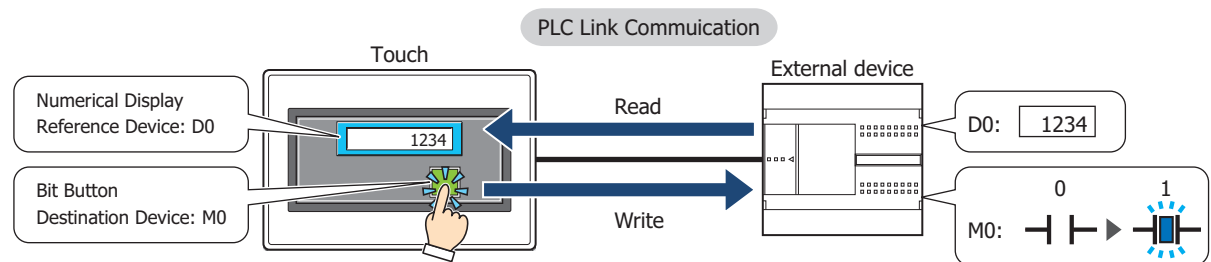

For details regarding the PLC Link Communication, refer to Chapter 1 "PLC Link Communication" and Chapter 2 "Connection to a PLC" in the "External Device Setup Manual".

*1 Unit names vary based on the manufacturer of the external device.

● PLC Link Connection Types

There are two basic types of connections. 1:1 Communication, where an external device is connected to a Touch; and 1:N Communication, where multiple external devices are connected to a Touch.

■ 1:1 Communication

The Touch is connected to a single external device.

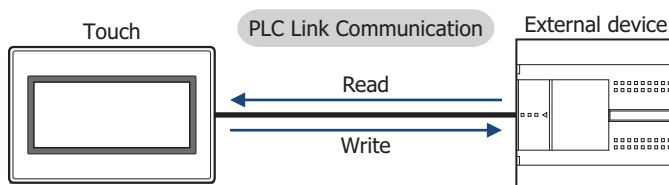

■ 1:N Communication

The Touch is connected to multiple external devices.

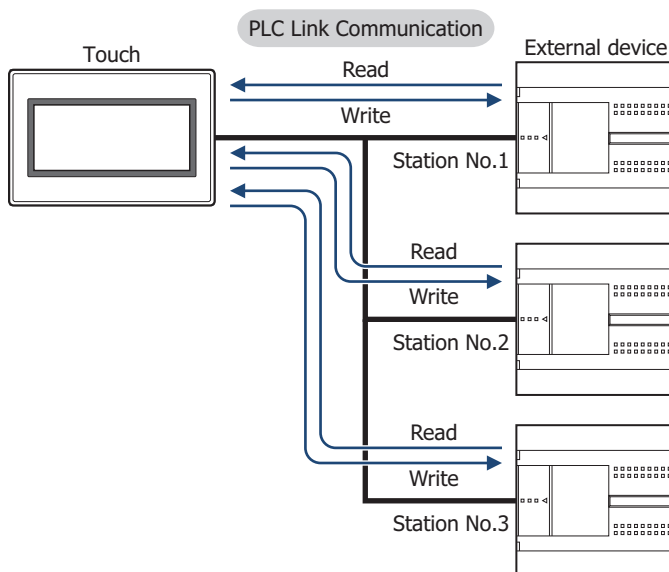

1.2 PLC Link Communication Settings

The external devices connected to the Touch and connection types are selected on the Select Communication Driver dialog box, or the Change Communication Driver dialog box.

- When creating new project data by following displayed dialog boxes and configuring settings step by step, by



clicking **New**, the Select Communication Driver dialog box is displayed. For details, refer to Chapter 3 "Create new project data by using the interactive quick start" on page 3-1.

- Click **Communication Driver** on the status bar to display the Change Communication Driver dialog box. For details, refer to Chapter 3 "Changing Communication Drivers" on page 3-15.

Specify **Manufacturer** and **Communication Driver** for each CPU Unit^{*1} or each PLC Link Unit^{*1} of the external device. For details regarding the correspondence model, refer to the "External Device Setup Manual."

*1 Unit names vary based on the manufacturer of the external device.

2 O/I Link Communication

2.1 Overview

O/I Link Communication is a protocol for communication between Master and Slave, where a Touch connected to the external device is configured as a Master and multiple Touch (Slaves) communicate with the external device via the Master.

The Master Touch unit communicates with the external device by means of PLC Link Communication. The Master Touch is called an O/I Link Master and a slave Touch connected to the O/I Link Master is called an O/I Link Slave. A maximum of 15 O/I Link Slaves can be connected to an O/I Link Master.

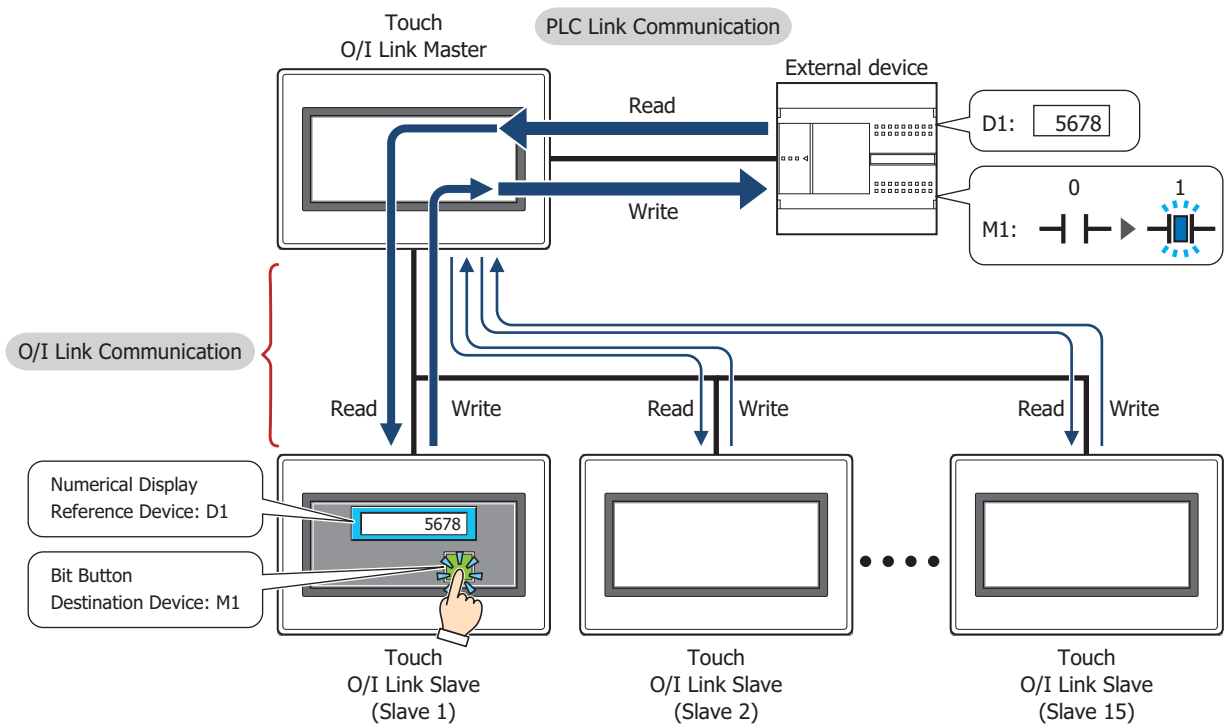

- The MICRO/I models that can communicate with the Touch using O/I Link Communication are the HG2G-S/-5S/-5F, and HG3G/4G.
- For details regarding the O/I Link Communication, refer to Chapter 3 "O/I Link Communication" in the "External Device Setup Manual".

2.2 O/I Link Communication Settings

These settings are configured under the **O/I Link** tab on the Project Settings dialog box. The Project Settings dialog box can also be accessed using the following methods.

- Click **Project** on the **Configuration** tab.
- Double click **Project Settings** in the **Project** window.

The O/I Link Communication Settings can only be configured when **O/I Link Master** or **O/I Link Slave** is selected in **Protocol** under **Interface Settings** on the **Communication Interface** tab. For details, refer to Chapter 3 "3.6 O/I Link Tab" on page 3-37.

3 DM Link Communication

3.1 Overview

DM Link Communication reads and writes value to external devices using the Touch's dedicated DM Link memory. The device type of dedicated DM Link memory is DM.

This method uses a dedicated IDEC protocol, so a communication program is required in the external device.

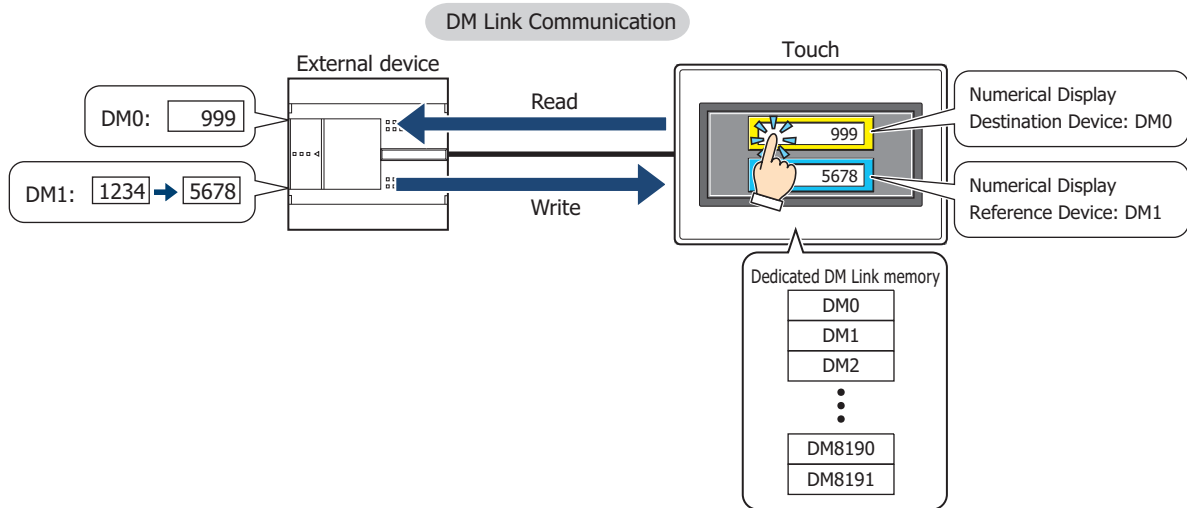

For details regarding the DM Link Communication, refer to Chapter 4 "DM Link Communication" in the "External Device Setup Manual".

● Communication Methods

There are two basic types of DM Link Communication. 1:1 Communication, where the Touch is connected to an external device; and 1:N Communication, where multiple Touch are connected to an external device.

■ 1:1 Communication

The external device is connected to a single Touch.

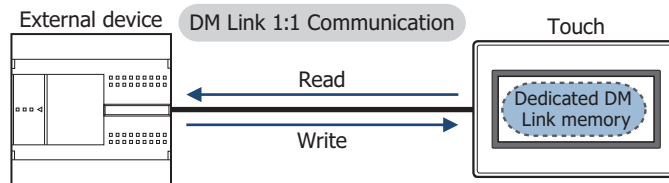

The Event Transmission function from the Touch can be used with 1:1 communication.

The Event Transmission function is a function that works as follows. When value in the dedicated DM Link memory of the Touch is changed, the data is transmitted from the Touch to the external device.

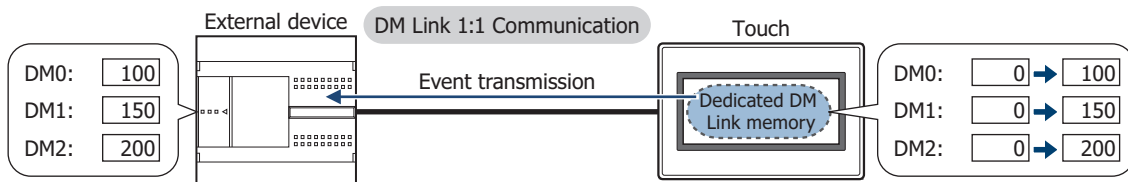

■ 1:N Communication

The external device is connected to multiple Touch.

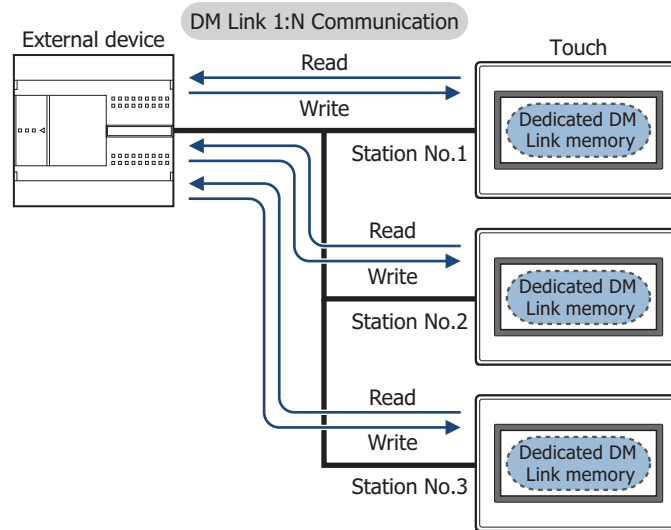

The Event Transmission function cannot be used with 1:N communication.

3.2 DM Link Communication Settings

DM Link Communication settings are selected on the Select Communication Driver dialog box, or the Change Communication Driver dialog box.

- When creating new project data by following displayed dialog boxes and configuring settings step by step, by



clicking , and then clicking **New**, the Select Communication Driver dialog box is displayed. For details, refer to Chapter 3 “Create new project data by using the interactive quick start” on page 3-1.

- Click **Communication Driver** on the status bar to display the Change Communication Driver dialog box. For details, refer to Chapter 3 “Changing Communication Drivers” on page 3-15.

Select **IDEC System** in **Manufacturer**, and then select **DM Link (1:1)** or **DM Link (1:N)** in **Communication Driver**.

4 No External Devices

4.1 Overview

In this case, there is no communication with an external device, so the Touch operates as a standalone unit. It is only possible to operate the Touch with relays and registers.

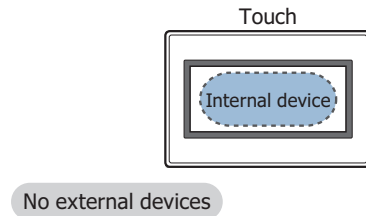

4.2 No External devices Settings

No external devices settings are selected on the Select Communication Driver dialog box, or the Change Communication Driver dialog box.

- When creating new project data by following displayed dialog boxes and configuring settings step by step, by

clicking , and then clicking **New**, the Select Communication Driver dialog box is displayed. For details, refer to Chapter 3 "Create new project data by using the interactive quick start" on page 3-1.

- Click **Communication Driver** on the status bar to display the Change Communication Driver dialog box. For details, refer to Chapter 3 "Changing Communication Drivers" on page 3-15.

Select **IDEC System** in **Manufacturer**, and then select **No External Device** in **Communication Driver**.

5 User Communication

5.1 Overview

User Communication allows you to develop a communication protocol to transmit and receive data from an external device, such as a bar code reader. The Touch supports the user communication with start and stop synchronization (full duplex) and a maximum of 1,500 bytes of data transmission or reception.

User Communication is supported up to three interfaces of the Touch, either serial, Ethernet, or USB interfaces.

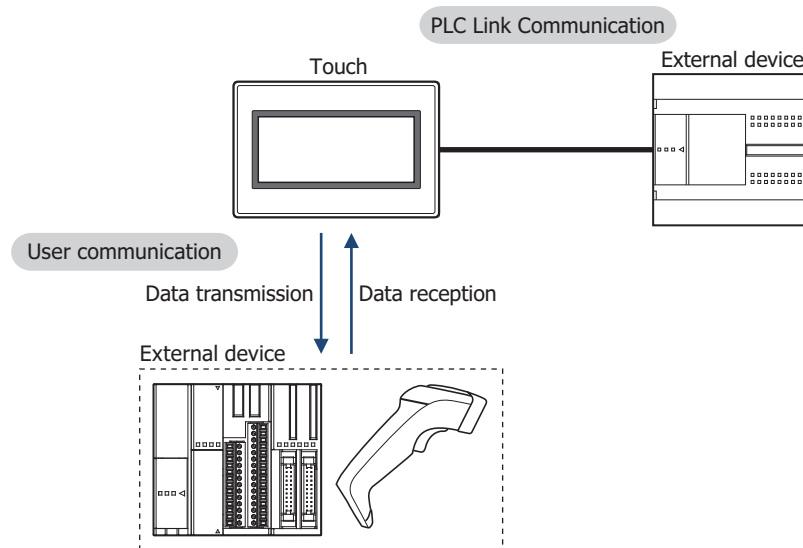

Up to 31 external devices can be connected when the serial interface is RS485. However, it is necessary to thoroughly check command settings, error handling, and other detailed command specifications when considering the capability of communicating with two or more external devices to decide the number of external devices to be connected.

5.2 User Communication Settings Procedure

This section describes the procedure for setting user communication.

- Setting user communication for a communication interface

- 1 On the **Configuration** tab, in the **System Setup** group, click **Project**.

The Project Settings dialog box is displayed.

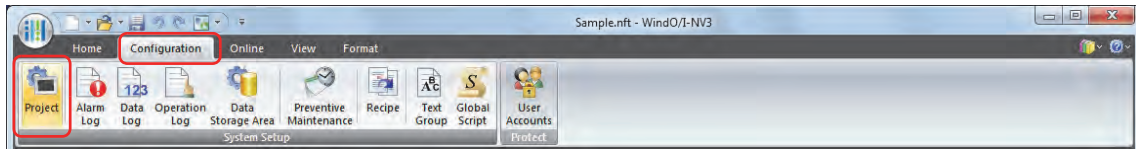

- 2 Click the **Communication Interface** tab.

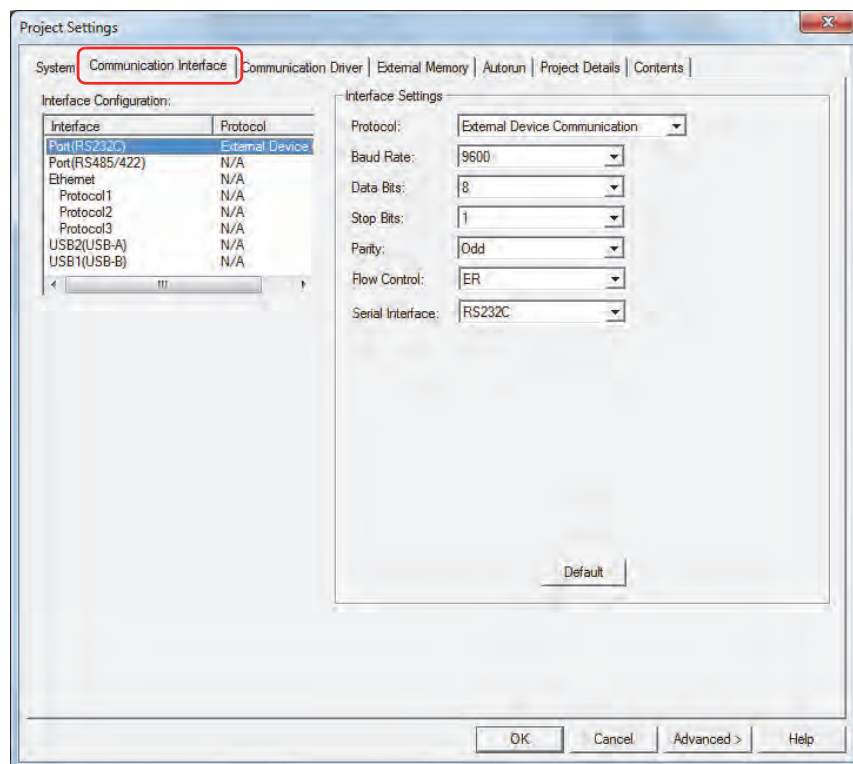

- 3 Select the interface for user communication under **Interface Configuration**, and then select the user communication in **Protocol** under **Interface Settings**.

The **User Communication** tab is displayed.

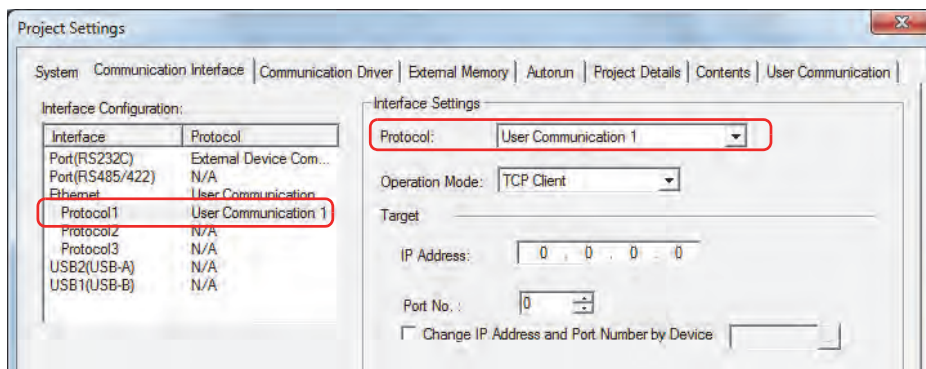

4 Specify the items for **Interface Settings**.

Setting items vary based on the interface.

- Serial Interface
 - ☞ For details, refer to Chapter 3 “When Port is selected under Interface Configuration” on page 3-28.
- Ethernet Interface
 - ☞ For details, refer to Chapter 3 “When Protocol1, Protocol2, or Protocol3 is selected for Ethernet under Interface Configuration” on page 3-30.
- USB Interface
 - ☞ For details, refer to Chapter 3 “When USB2 is selected under Interface Configuration” on page 3-31.

5 Click the **User Communication** tab.

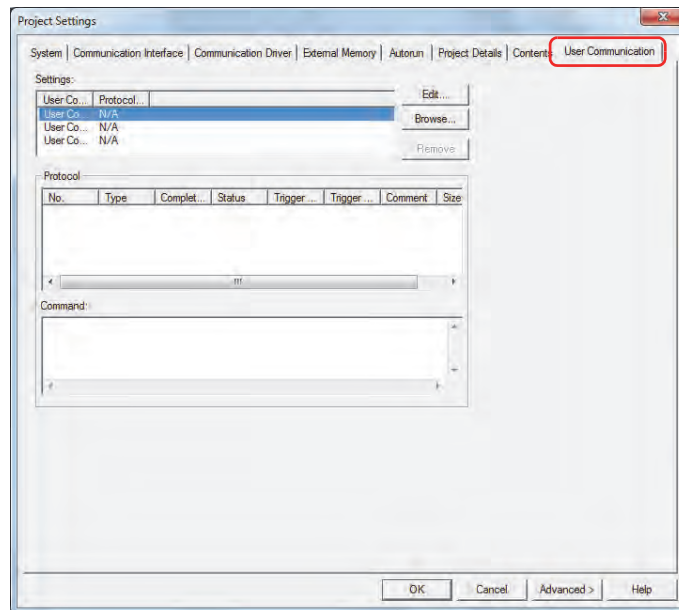

6 Select the user communication under **Settings**, and then click **Browse**.

Select the user communication configured on the **Communication Interface** tab. Protocol Manager is displayed.

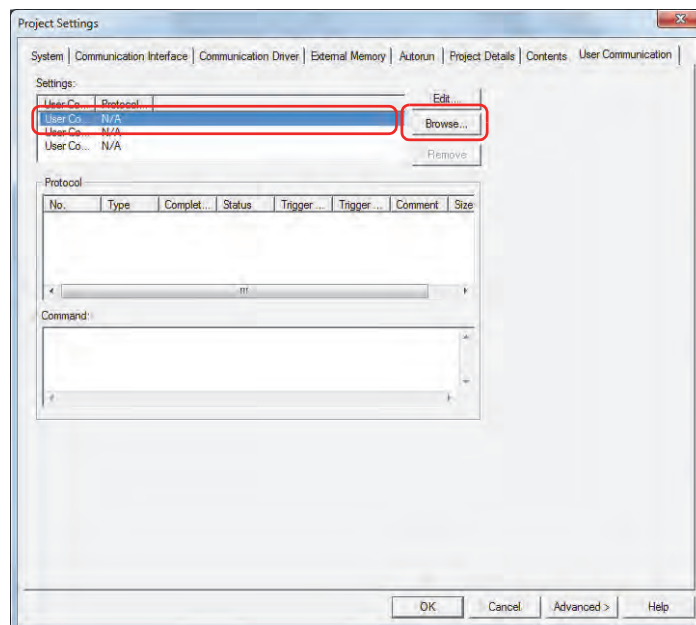

- 7 Select the user communication protocol under **Protocol List**, and then click **Select**.

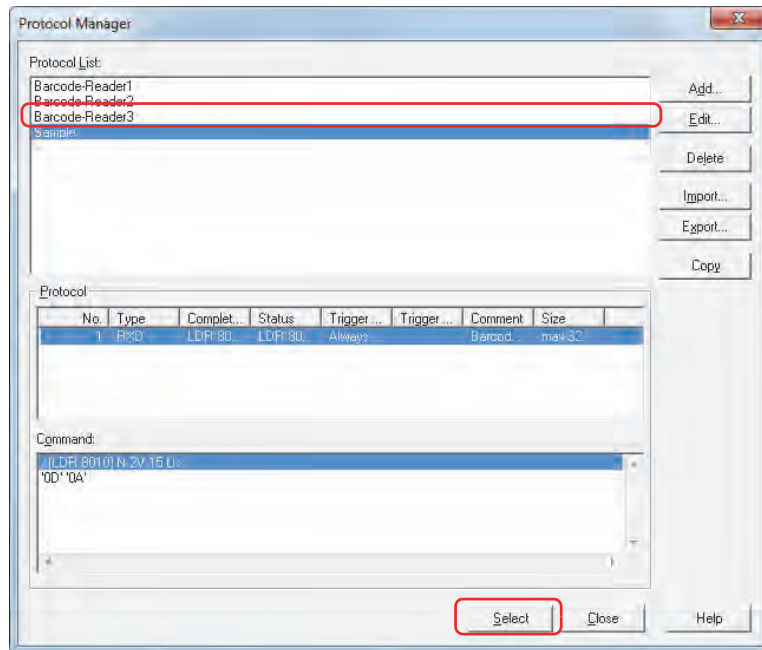

The name of the configured user communication protocol set on the **User Communication** tab in the Project Settings dialog box is displayed in **Protocol Name** under **Settings**, and the protocol settings are displayed under **Protocol**. In addition, the command settings selected under **Protocol** are displayed under **Command**.

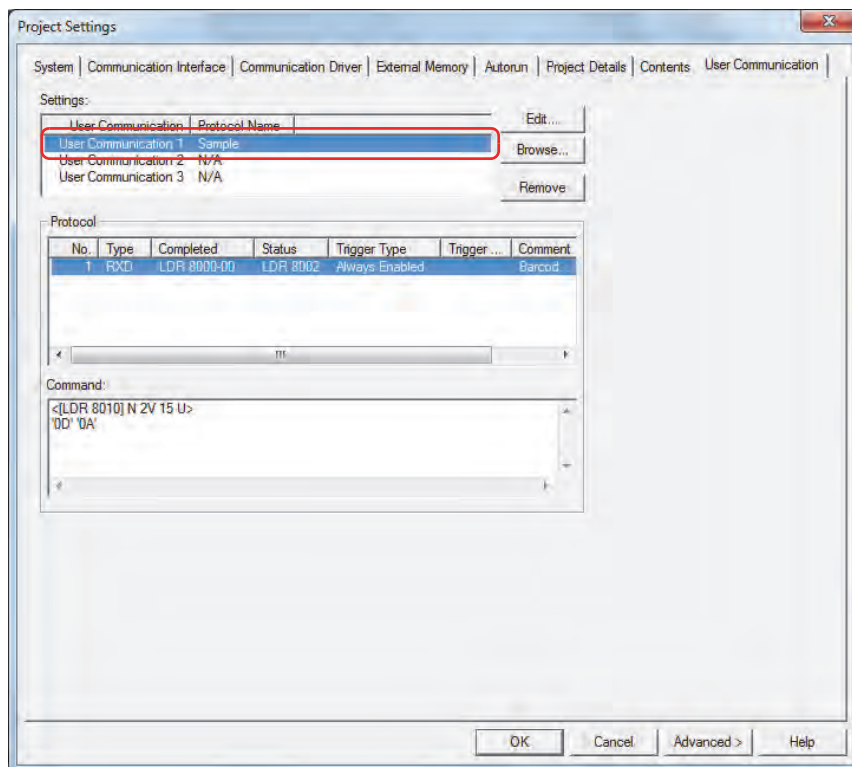

- 8 Click **OK**.

This concludes configuring user communication for communication interfaces.

● Creating a New User Communication Protocol

- 1 On the **View** tab, in the **Workspace** group, click  (Protocol Manager). Protocol Manager is displayed.

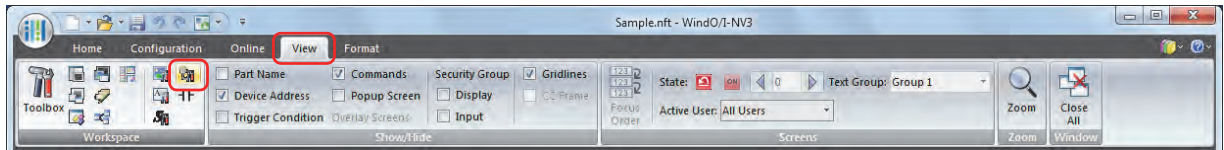

- 2 Click **Add**.

The User Communication Protocol Settings dialog box is displayed.

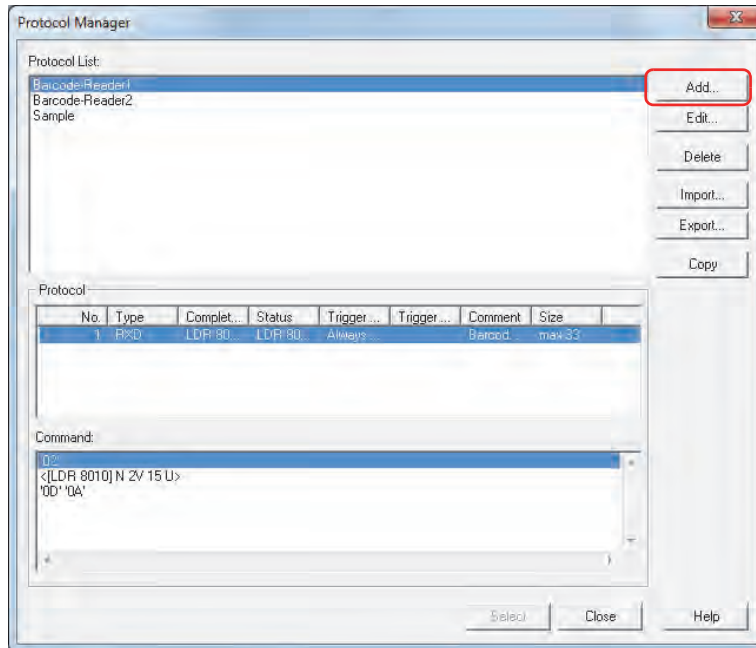

- 3 Enter the name of the user communication protocol in the **Protocol Name**. The maximum number for protocol name is 40 characters.



You cannot use the following characters in the protocol name.

\\ : , ; * ? " < > |

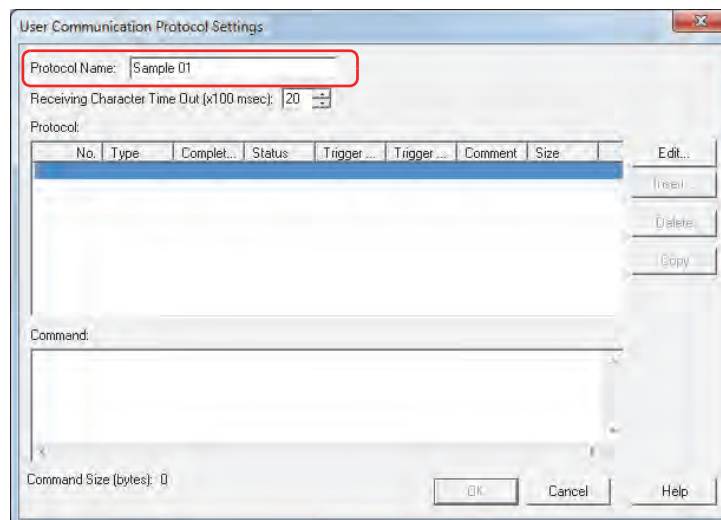

- 4 Set the time out (0 to 255) from when 1 frame of data has been received to when the next frame of data starts to be received in **Receiving Character Time Out (x100 msec)**.

A frame refers to a data string from the beginning to the end of a command. These setting items are used only with receive command.

- 5 Click **Edit**.

The Command Settings dialog box is displayed.

- 6 Set Transmission (TXD) command.

Enter a comment for transmission command in **Comment**.

The maximum number is 40 characters.

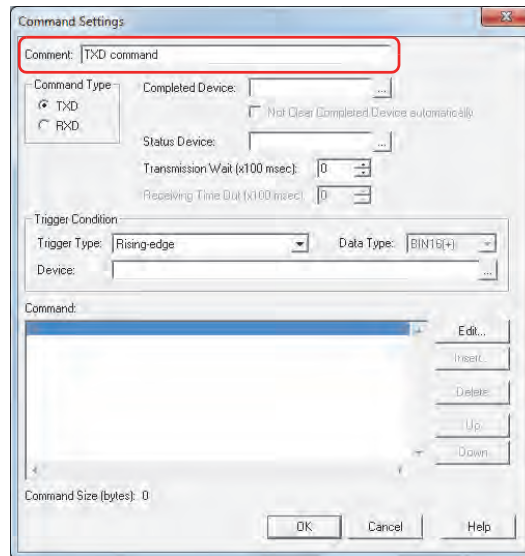

- 7 Select **TXD** in **Command Type**.

Specify the transmitted data to the external device connected to the Touch and the conditions for transmitting data.

- 8 Specify the bit device or bit of the word device for reporting that data transmission was successfully completed in **Completed Device**.

Click to display the Device Address Settings dialog box. For the device address configuration procedure, refer to Chapter 2 "5.1 Device Address Settings" on page 2-61.

- 9 Specify the destination word device for the transmitted data size and error information in **Status Device**.

Click to display the Device Address Settings dialog box. For the device address configuration procedure, refer to Chapter 2 "5.1 Device Address Settings" on page 2-61.

- 10 Set the wait time (0 to 255) from when the trigger condition is satisfied to when the data is transmitted in **Transmission Wait (x100 msec)**.

- 11 Select the condition to transmit data in **Trigger Type** under **Trigger Condition** from the following.

■ **Rising-edge**

Data is transmitted when the value of device changes from 0 to 1.

Specify the bit device or bit of the word device as the condition.

Click to display the Device Address Settings dialog box. For the device address configuration procedure, refer to Chapter 2 "5.1 Device Address Settings" on page 2-61.

■ **Falling-edge**

Data is transmitted when the value of device changes from 1 to 0.

Specify the bit device or bit of the word device as the condition.

Click to display the Device Address Settings dialog box. For the device address configuration procedure, refer to Chapter 2 "5.1 Device Address Settings" on page 2-61.

■ Satisfy the condition

Data is transmitted when condition changes from not satisfied to satisfied.

Specify the conditional expression in **Condition** and select the data type handled by the conditional expression in **Data Type**.

Click  to display the Trigger Condition Settings dialog box. For the conditional expressions configuration procedure, refer to Chapter 2 “5.2 Setting Conditional Expressions” on page 2-63

For details on data types, refer to Chapter 2 “1.1 Available Data” on page 2-1.

■ Fixed Period

Data is transmitted at a fixed time interval.

Set the time interval between data transmissions as 1 to 3600 (seconds) in **Period (sec)**.

12 Set data for transmission command.

Click **Edit**.

The Data Settings dialog box is displayed.

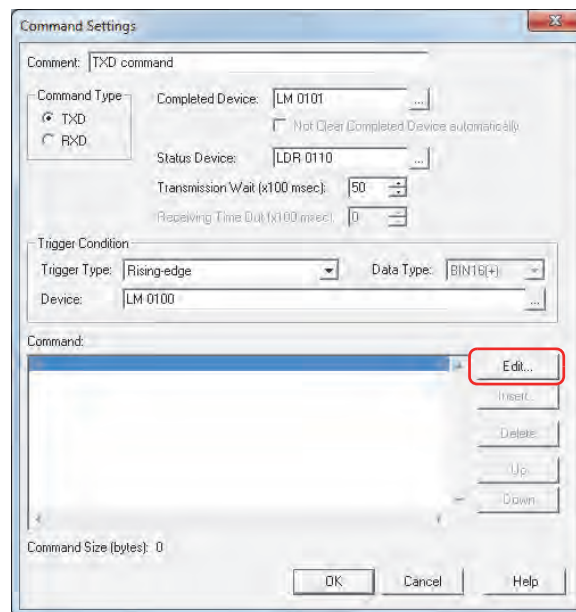

13 Select data type in **Type**.

Data setting items are displayed.

For details on transmission command, refer to “Transmission (TXD) Command” on page 22-37.

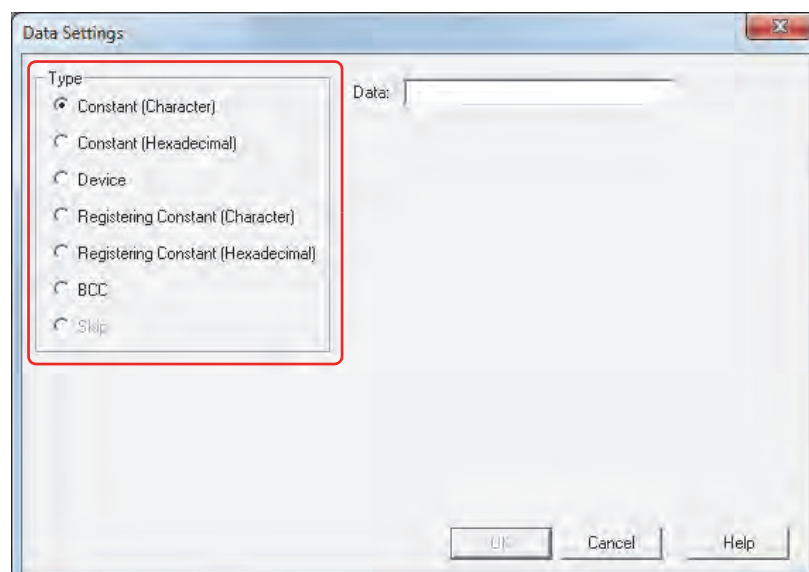

- 14 Set the data, and then click **OK**.

The data configured in **Command** is displayed.

- 15 Repeat steps 12 through 14 to set all the data for the transmission command.

Command Settings

Comment: TXD command

Command Type: TXD RXD

Completed Device: LM 0101

Not Clear Completed Device automatically

Status Device: LDR 0110

Transmission Wait (x100 msec): 50

Receiving Time Out (x100 msec): 0

Trigger Condition

Trigger Type: Rising-edge

Data Type: BIN16(+)

Device: LM 0100

Command:

```
'05'
'04'
[LDR 0100] B16-A 4 1 U>
'00'
```

Command Size (bytes): 7

Buttons: Edit..., Insert..., Delete, Up, Down, OK, Cancel, Help



The data are displayed in **Command** in the order they were set. To change the order of data, select data, and then click **Up** or **Down** to shift it.

- 16 Click **OK**.

The transmission command configured under **Protocol** is displayed.

- 17 Specify Receive (RXD) command.

Click **Edit**.

User Communication Protocol Settings

Protocol Name: Sample 01

Receiving Character Time Out (x100 msec): 30

No.	Type	Comple...	Status	Trigger ...	Trigger ...	Comment	Size	
1	TXD	LM 0101	LDR 01...	Rising-e...	[LM 0100]	TXD co...	7	Edit...

Buttons: Insert..., Delete, Copy

Command:

Command Size (bytes): 0

Buttons: OK, Cancel, Help

18 Specify Receive (RXD) command.

Enter a comment for receive command in **Comment**.
The maximum number is 40 characters.

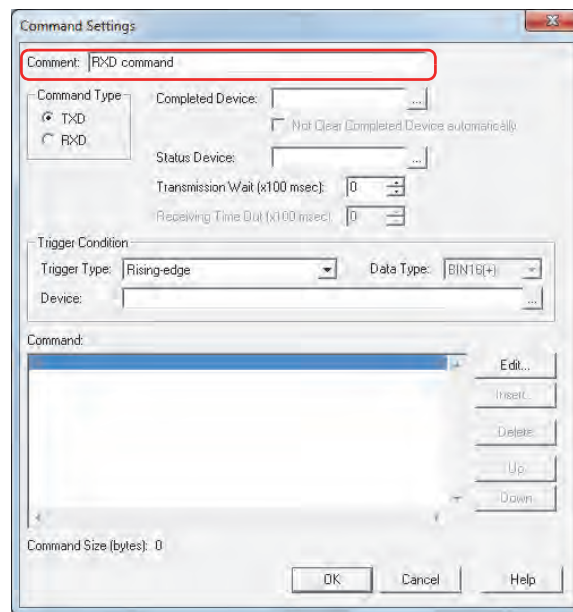
**19** Select **RXD** in **Command Type**.

Define the data configuration for received data from the external device.

20 Specify the bit device or bit of the word device for reporting that data receiving was successfully completed in **Completed Device**.

Click to display the Device Address Settings dialog box. For the device address configuration procedure, refer to Chapter 2 "5.1 Device Address Settings" on page 2-61.

If the value of Completed Device automatically is not set to 0 after it is set to 1, select the **Not Clear Completed Device automatically** check box.

21 Specify the destination word device for the received data size and error information in **Status Device**.

Click to display the Device Address Settings dialog box. For the device address configuration procedure, refer to Chapter 2 "5.1 Device Address Settings" on page 2-61.

22 Select the condition for being ready to receive data in **Trigger Type** under **Trigger Condition** from the following.

- **Always Enabled**

The device is always ready to receive data. Proceed to step **24**.

- **While ON**

Ready to receive data when the value of device is 1.

Specify the bit device or bit of the word device as the condition.

Click to display the Device Address Settings dialog box. For the device address configuration procedure, refer to Chapter 2 "5.1 Device Address Settings" on page 2-61.

- **While OFF**

Ready to receive data when the value of device is 0.

Specify the bit device or bit of the word device as the condition.

Click to display the Device Address Settings dialog box. For the device address configuration procedure, refer to Chapter 2 "5.1 Device Address Settings" on page 2-61.

- **While satisfying the condition**

Ready to receive data while a condition is satisfied.

Specify the conditional expression in **Condition** and select the type of data handled by the conditional expression in **Data Type**.

Click to display the Trigger Condition Settings dialog box. For the conditional expressions configuration procedure, refer to Chapter 2 "5.2 Setting Conditional Expressions" on page 2-63.

For details on data types, refer to Chapter 2 "1.1 Available Data" on page 2-1.

- 23** Set the time out (0 to 255) from when the trigger condition is satisfied in **Receiving Time Out (x100 msec)** to when 1 frame of data has been received.
A frame refers to a data string from the beginning to the end of a command.
- 24** Set data for receive command.
Click **Edit**.
The Data Settings dialog box is displayed.

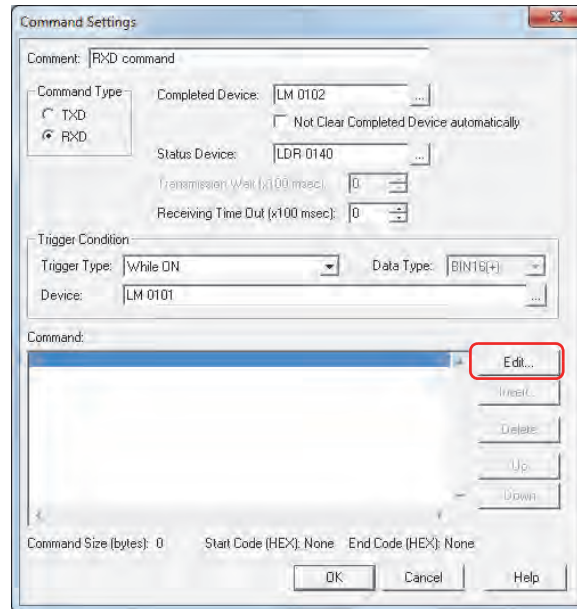

- 25** Select data type in **Type**.
Data setting items are displayed.
For details on receive command, refer to “Receive (RXD) Command” on page 22-50.

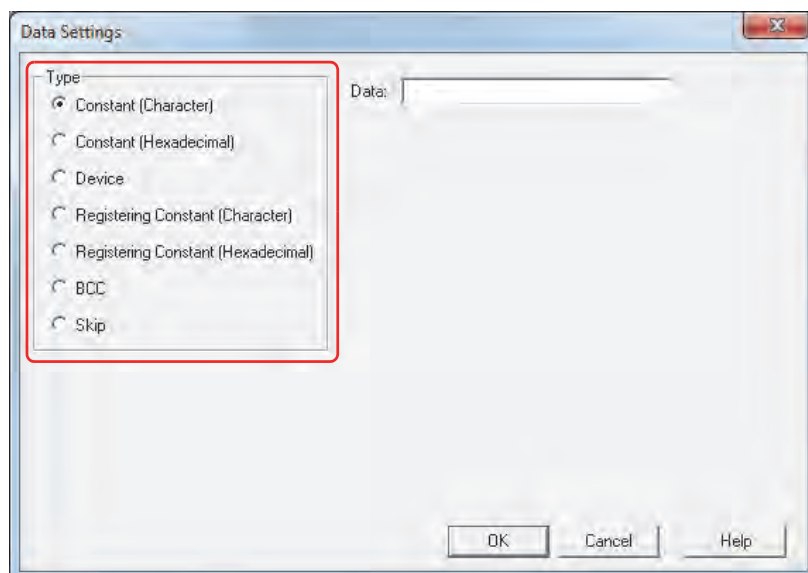

- 26** Specify the data, and then click **OK**.
The data configured in **Command** on the Command Settings dialog box is displayed.

27 Repeat steps 24 through 26 to specify all the data for the receive command.

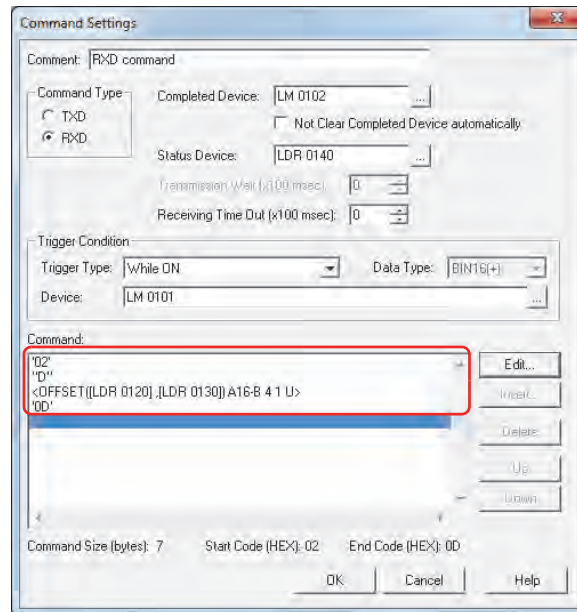

The data are displayed in **Command** in the order they were set. To change the order of data, select data, and then click **Up** or **Down** to shift it.

28 Click **OK**.

The receive command configured in **Protocol** on the User Communication Protocol Settings dialog box is displayed.

To add a transmission command, repeat steps 5 through 16.

To add a receive command, repeat steps 17 through 28.

29 Configure all commands, click **OK**.

User communication protocols are registered in **Protocol List** on Protocol Manager.

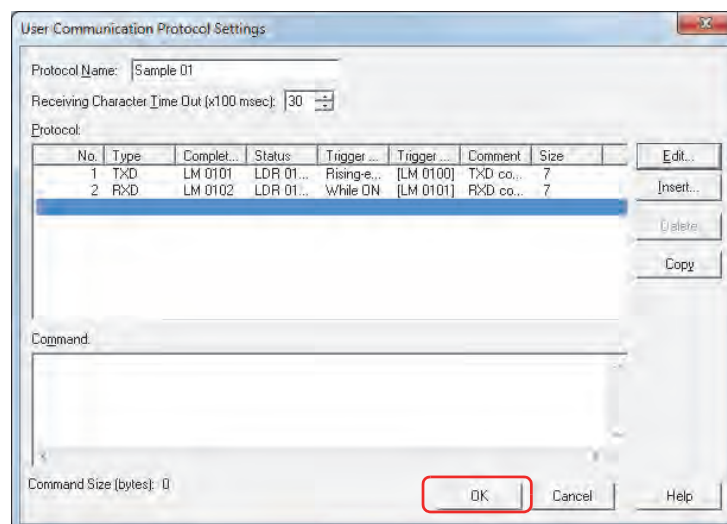

30 Click **Close**.

This concludes registering user communication protocol.

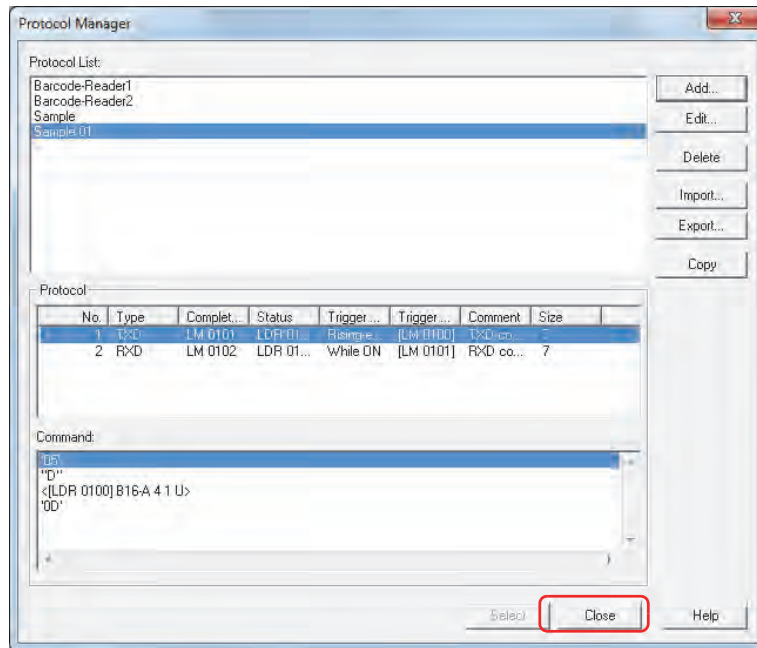

- Using registered user communication protocol on another computer

Saving registered user communication protocol as a file

To use the user communication protocol registered in Protocol Manager on another computer, save it as a file.

- 1 On the **View** tab, in the **Workspace** group, click  (Protocol Manager).

Protocol Manager is displayed.

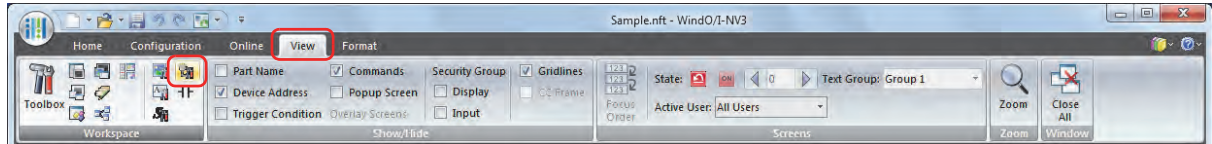

- 2 Select the user communication protocol in **Protocol List**, and then click **Export**.

The Save As dialog box is displayed.



To select multiple user communication protocols, press and hold SHIFT or CTRL while you click the specific items.

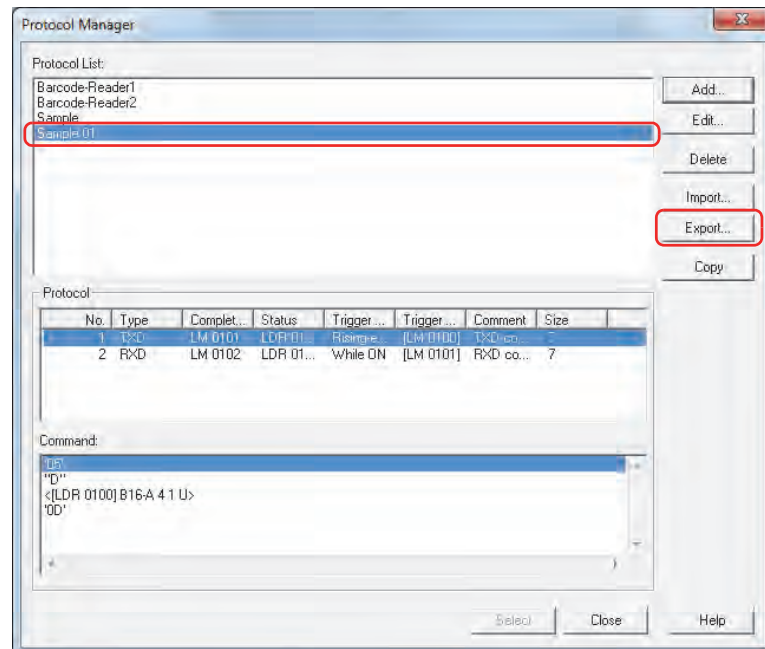

- 3 Specify **Save in**, and then click **Save**.

The name of the saved file will be the name of the protocol.

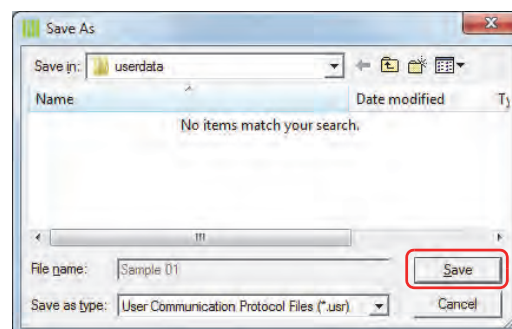

Importing user communication protocol

- 1 On the **View** tab, in the **Workspace** group, click  (Protocol Manager).
Protocol Manager is displayed.

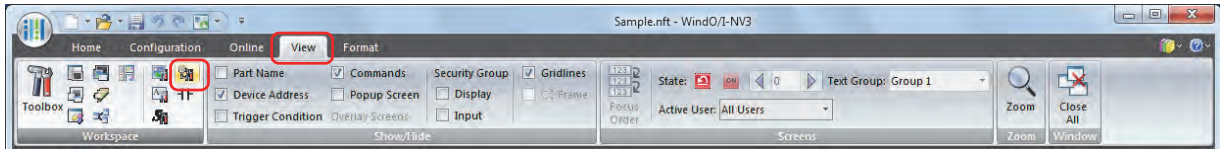

- 2 On Protocol Manager, click **Import**.
The Open dialog box is displayed.



To select multiple user communication protocols, press and hold SHIFT or CTRL while you click the specific items.

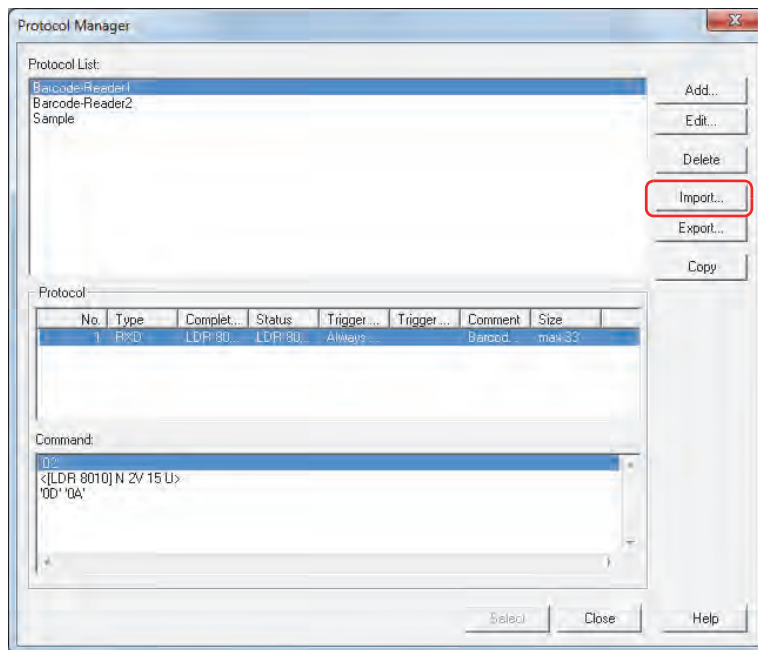

- 3 Specify the user communication protocol file, and then click **Open**.

The user communication protocol is registered in Protocol Manager. The name of the user communication protocol file is set as the name of the protocol.

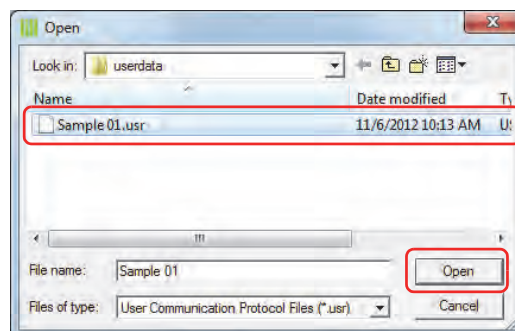

When a user communication protocol file with the protocol name already exists, a confirmation message is displayed.

- Click **Overwrite** to overwrite the existing user communication protocol.
- Click **Rename** to display the Protocol File Name Settings dialog box. Enter a new name for **Protocol File Name**, and then click **OK** to add the user communication protocol with the protocol name entered for **Protocol File Name**. For details, refer to "Protocol File Name Setting Dialog Box" on page 22-25.
- Click **Cancel** to stop importing the user communication protocol.

5.3 Protocol Manager

The protocol for user communication is collectively managed in Protocol Manager.

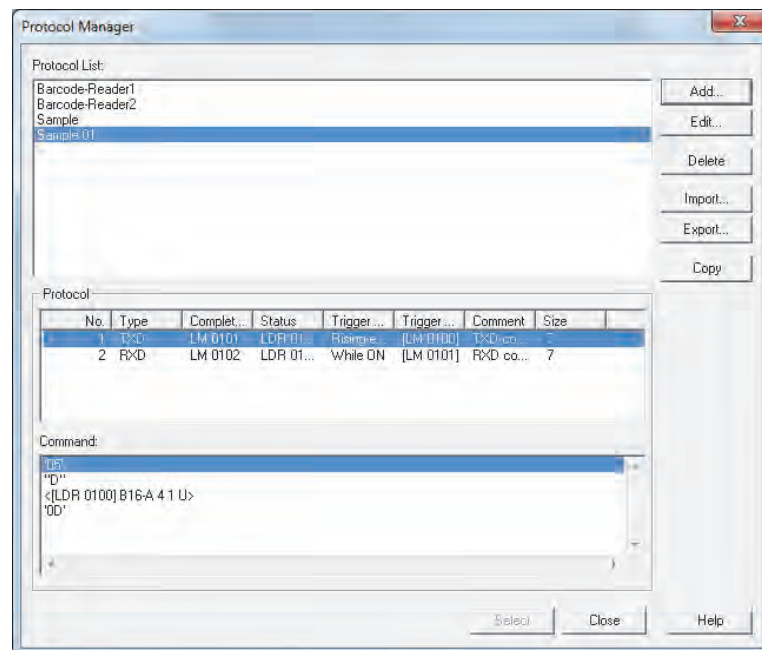

■ Protocol List

Displays a list of registered user communication protocols and sample protocols provided by WindO/I-NV3.



The bar code reader protocols such as Barcode-Reader1, Barcode-Reader2, and Barcode-Reader3 are supplied as samples with WindO/I-NV3.

■ Add

Adds user communication protocols to the Protocol List.

Click this button to display the User Communication Protocol Settings dialog box. Specify the user communication protocol to be registered in the User Communication Protocol Settings dialog box. For details, refer to “User Communication Protocol Settings Dialog Box” on page 22-23.

■ Edit

Changes the selected user communication protocol.

Click this button to display the User Communication Protocol Settings dialog box. Change the user communication protocol in the User Communication Protocol Settings dialog box. For details, refer to “User Communication Protocol Settings Dialog Box” on page 22-23.

■ Delete

Deletes the selected user communication protocol.

■ Import

Imports a saved user communication protocol file. Click this button to display the Open dialog box. For details, refer to “Importing user communication protocol” on page 22-20.

■ Export

Export and saves a selected user communication protocol as a file.

Click this button to display the Save As dialog box. For details, refer to “Saving registered user communication protocol as a file” on page 22-19.

Saved user communication protocols can be imported using **Import**.

■ Copy

Copies the selected user communication protocol.

Click this button to display the Protocol File Name Settings dialog box. For details, refer to “Protocol File Name Setting Dialog Box” on page 22-25.

■ Protocol

The command settings for the user communication protocol selected in the Protocol List are displayed.

- No.: Shows the number for managing command settings. Double clicking the cell displays the Command Settings dialog box.
- Type: Shows the type of command. Double clicking the cell displays the Command Settings dialog box.
- Completed: Shows the device for reporting when transmission or receiving of data is successfully completed. Double clicking the cell displays the Command Settings dialog box.
- Status: Shows the destination device for the transmitted or received data size and error information. Double clicking the cell displays the Command Settings dialog box.
- Trigger Type: Shows the trigger type for data transmission or being ready to receive data. Double clicking the cell displays the Command Settings dialog box.
- Condition: Shows the condition of trigger type for data transmission or being ready to receive data. The displayed content varies based on **Trigger Type**.
- Always Enabled:** Trigger conditions are not necessary, so nothing is displayed.
- Rising-edge, Falling-edge, While ON, or While OFF:**
Shows the bit device as the condition. Double clicking the cell displays the Command Settings dialog box.
- While satisfying the condition or Satisfy the condition:**
Shows the conditional expression.
- Fixed Period:** Shows the period in seconds.
- Comment: Shows the command comment. Double clicking the cell displays the Command Settings dialog box.
- Size: Shows the command data size in bytes. Double clicking the cell displays the Command Settings dialog box.

■ Command

Shows a list of command settings for the selected user communication protocol. Double clicking the line displays the Data Settings dialog box.

■ Select

The highlighted user communication protocol in the protocol list is selected and Protocol Manager is closed.

■ Close

Close Protocol Manager.

● User Communication Protocol Settings Dialog Box

The command for user communication protocol is collectively managed in the User Communication Protocol Settings dialog box.

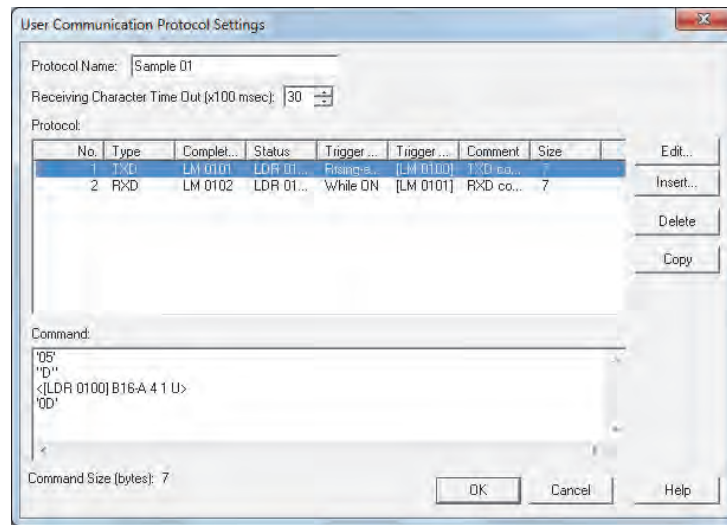

■ Protocol Name

Enter the name of the user communication protocol. The maximum number for protocol name is 40 characters.



You cannot use the following characters in the protocol name.

\\ : , ; * ? " < > |

■ Receiving Character Time Out (x100 msec)

Specify the time out value (0 to 255) from when 1 frame of data has been received to when the next frame of data starts to be received. A frame refers to a data string from the beginning to the end of a command. If the Receiving Character Time Out is set to 0, it is not monitored. These setting items are used only with receive command.

Example: When the received data (1 frame) is 2 bytes, **While ON** is selected as **Trigger Type** in **Trigger Condition** and LM100 is set to **Device**, LM101 is set to **Completed Device**, and LDR110 is set to **Status Device**

The data of second byte starts to be received before exceeding the Receiving Character Time Out duration after the data of first byte is received, and the values of the Completed Device and Status Device when receiving of the data has been successfully completed are as follows.

- The value of the Completed Device LM101 changes to 1.

When the **Not Clear Completed Device automatically** check box is not selected, when the value of the Trigger Condition device LM100 changes from 0 to 1, the value of the Completed Device LM101 changes to 0.

When the **Not Clear Completed Device automatically** check box is selected, the value of Completed Device LM101 remains 1, so set 0 if necessary.

- The value of the Receiving Character Time Out (address+0, bit 15) of the Status Device LDR110 remains 0.

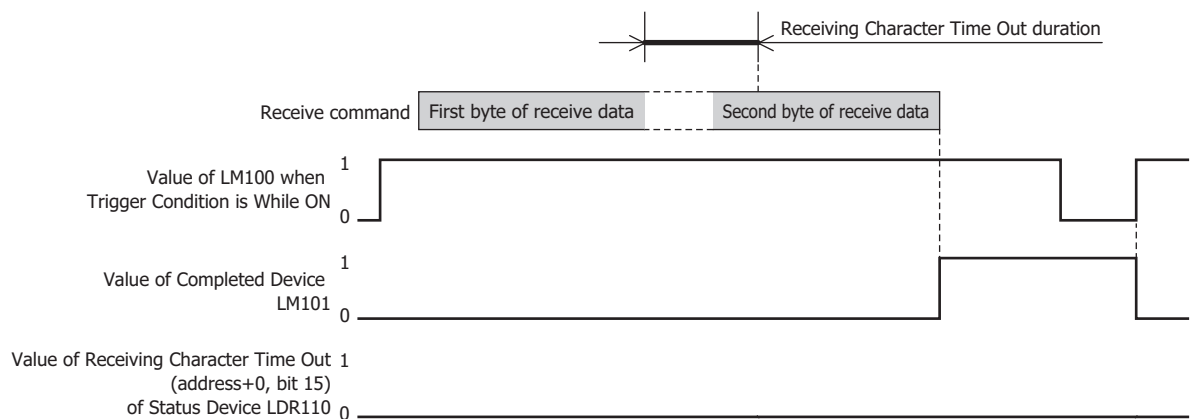

When the Receiving Character Time Out duration exceeds until the data of second byte starts to be received after the data of first byte is received, the value of the Receiving Character Time Out (address+0, bit 15) of the Status Device LDR110 changes to 1 and the Completed Device LM101 remains 0. In addition, when the value of the Trigger Condition device LM100 changes from 0 to 1, the value of LDR110 (address +0, bit 15) changes to 0.

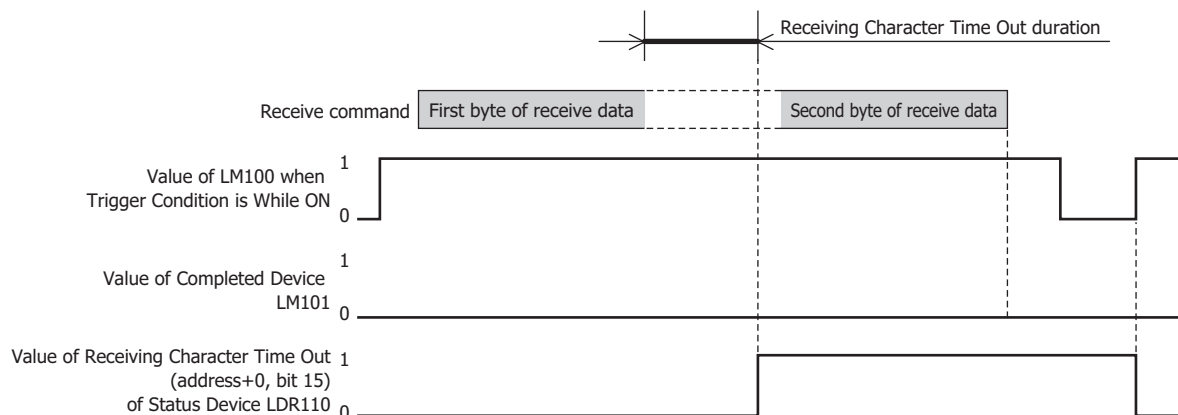

■ Protocol

Displays a list of command settings for the user communication protocol selected during editing. The maximum amount that can be configured is 32 commands per protocol.

No.: Shows the number for managing command settings. Double clicking the cell displays the Command Settings dialog box.

Type: Shows the type of command. Double clicking the cell displays the Command Settings dialog box.

Completed: Shows the device for reporting when transmission or receiving of data is successfully completed. Double clicking the cell displays the Device Address Settings dialog box.

Status: Shows the destination device for the transmitted or received data size and error information. Double clicking the cell displays the Device Address Settings dialog box.

Trigger Type: Shows the trigger type for data transmission or being ready to receive data. Double clicking the cell displays the Command Settings dialog box.

Condition: Shows the condition of trigger type for data transmission or being ready to receive data. The displayed content varies based on **Trigger Type**.

Always Enabled: Trigger conditions are not necessary, so nothing is displayed.

Rising-edge, Falling-edge, While ON, or While OFF:

Shows the bit device as the condition. Double clicking the cell displays the Command Settings dialog box.

While satisfying the condition or Satisfy the condition:

Shows the conditional expression.

Fixed Period: Shows the period.

Comment: Shows the command comment. Double clicking the cell displays the Command Settings dialog box.

Size: Shows the command data size in bytes. Double clicking the cell displays the Command Settings dialog box.

■ Edit

Adds or changes commands.

To add a command, select an empty line for the protocol, and then click this button. To change a command, select a command for the protocol, and then click this button. For details, refer to "Command Settings Dialog Box" on page 22-26.

■ Insert

Inserts a command in the selected position of the protocol.

Click this button to insert a command. The command at the insertion position shift down 1 line. When 32 commands are already set, you cannot insert a command. For details, refer to "Command Settings Dialog Box" on page 22-26.

■ Delete

Deletes the selected command.

■ Copy

Copies the selected command.

Click this button to copy the selected command and add it to the end of the Protocol List.

■ Command

Displays data of the command selected in the protocol. Double clicking the line displays the Data Settings dialog box.

■ Copy to Protocol Manager

Copies a user communication protocol during editing and copies it to Protocol Manager.

Click this button to copy the user communication protocol and add it to the Protocol List of Protocol Manager.

This is enabled only when the User Communication Protocol Settings dialog box under the **User Communication** tab on the Project Settings dialog box is displayed.

When a protocol of the same name has already been saved, an overwrite confirmation message is displayed.

Click **Overwrite** to overwrite the existing protocol.

Click **Rename** to display the Protocol File Name Settings dialog box. Enter a new protocol name, and then click **OK** to save the protocol.

Click **Cancel** to stop saving the protocol.



The User Communication Protocol Settings dialog box under the **User Communication** tab on the Project Settings dialog box can be displayed in the following ways.

- Click **Edit**.
- Click **Browse**, and then click **Add** or **Edit** in Protocol Manager.

■ OK

Adds or changes the user communication protocol and closes the User Communication Protocol Settings dialog box.

When a protocol of the same name has already been saved, an overwrite confirmation message is displayed.

Click **Overwrite** to overwrite the existing protocol.

Click **Rename** to display the Protocol File Name Settings dialog box. Enter a new protocol name, and then click **OK** to save the protocol.

Click **Cancel** to stop saving the protocol.

■ Cancel

Closes the User Communication Protocol Settings dialog box, without adding or changing the user communication protocol.

Protocol File Name Setting Dialog Box

Specify the name of a user communication protocol.

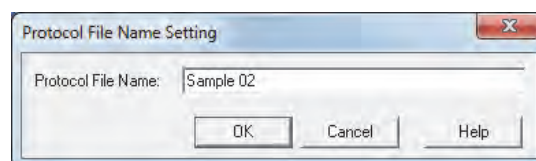

■ Protocol File Name

Enter the name of the user communication protocol. The maximum number for protocol name is 40 characters.



You cannot use the following characters in the protocol name.

\ / : , ; * ? " < > |

● **Command Settings Dialog Box**

Specify the command details for user communication protocol.

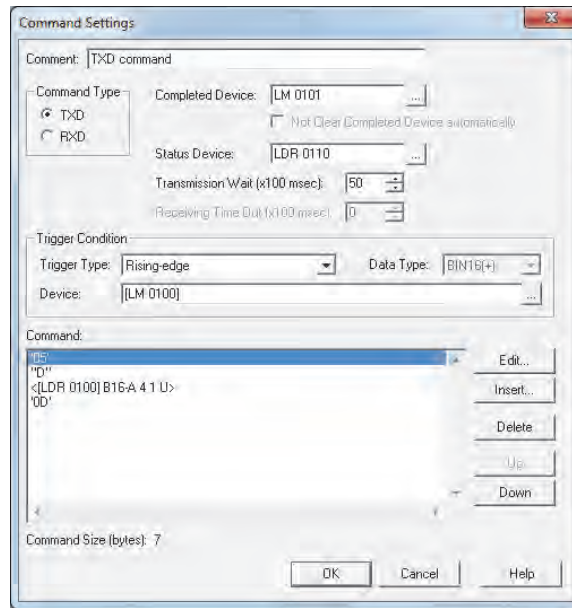

■ **Comment**

Enter a comment for a command. The maximum number is 40 characters.

■ **Command Type**

Select the type of communication command from the following items.

TXD: A command for data transmission from the Touch to an external device.

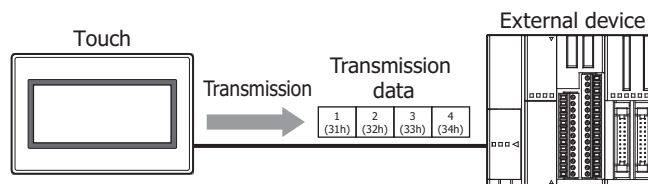

Processing of transmission command is as follows.

Example: When **Trigger Type** in **Trigger Condition** is **Rising-edge**, **Device** is LM100 and **Completed Device** is LM101

When the value of the Trigger Condition device LM100 changes to 1, data is transmitted by user communication from the Touch to the external device. When data transmission is successfully completed, the value of the Completed Device LM101 changes to 1.

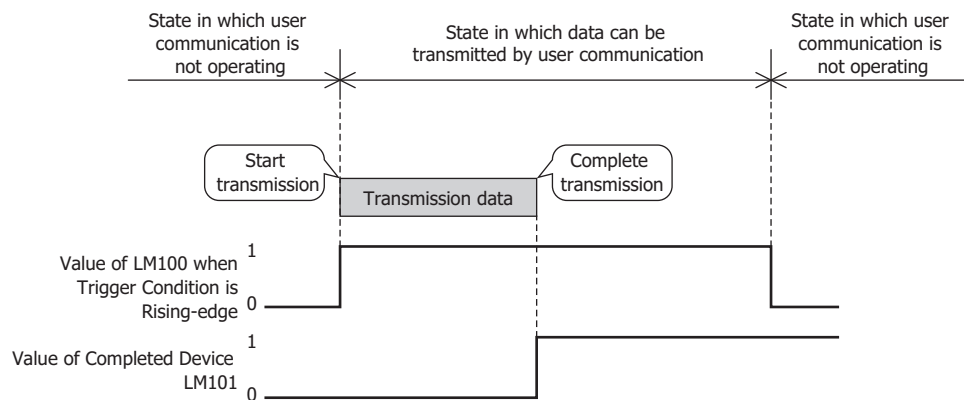

RXD: A command for analyzing and processing data received by the Touch from an external device.

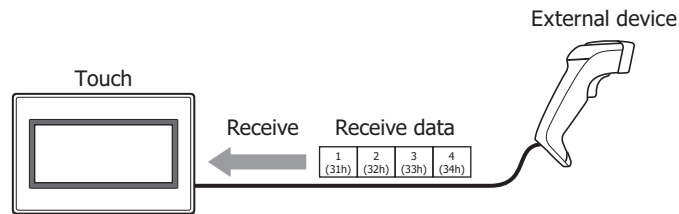

Processing of receive command is as follows.

Example: When **Trigger Type** in **Trigger Condition** is **While ON**, **Device** is LM100 and **Completed Device** is LM101

When the value of the Trigger Condition device LM100 changes to 1, data can be received (ready to receive) by user communication, so when data is transmitted from the external device, the Touch starts to receive the data. When data receiving is successfully completed, the value of the Completed Device LM101 changes to 1.

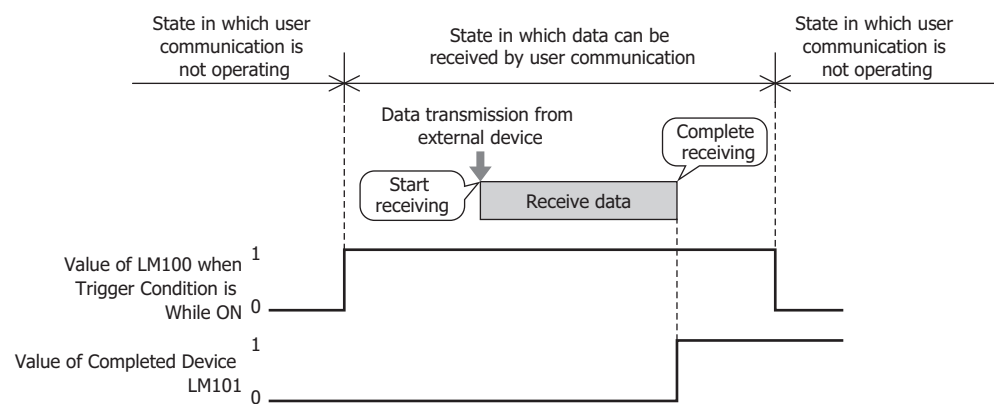

■ Completed Device

Specify the bit device or bit of the word device for reporting that data transmission or receiving was successfully completed. You can only specify an internal device.

Click to display the Device Address Settings dialog box. For the device address configuration procedure, refer to Chapter 2 "5.1 Device Address Settings" on page 2-61.

Example: When **Trigger Type** in **Trigger Condition** is **While ON**, **Device** is LM100 and **Completed Device** is LM101

When data receiving is successfully completed, the value of the Completed Device LM101 changes to 1. When the value of the Trigger Condition device LM100 changes from 0 to 1, the value of the Completed Device LM101 changes to 0.

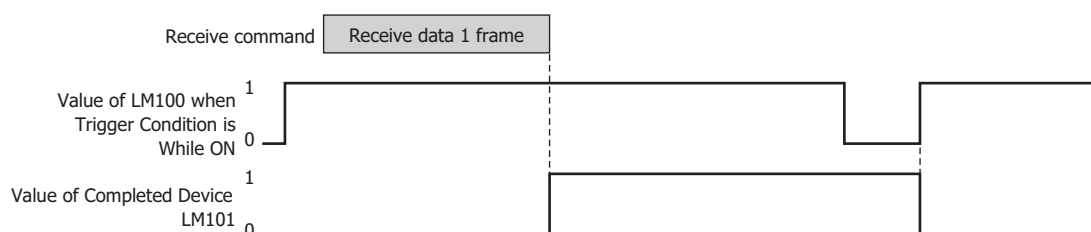

■ Not Clear Completed Device automatically

Select this check box when the value of the Completed Device is not set to 0 automatically after it changes to 1. This can be configured when **RXD** is selected in **Command Type**.

Example: When **Trigger Type** in **Trigger Condition** is **While ON**, **Device** is LM100 and **Completed Device** is LM101

When the **Not Clear Completed Device automatically** check box is not selected:

When data receiving is successfully completed, the value of the Completed Device LM101 changes to 1. When the first data of the next frame is received, the value of the Completed Device LM101 changes to 0.

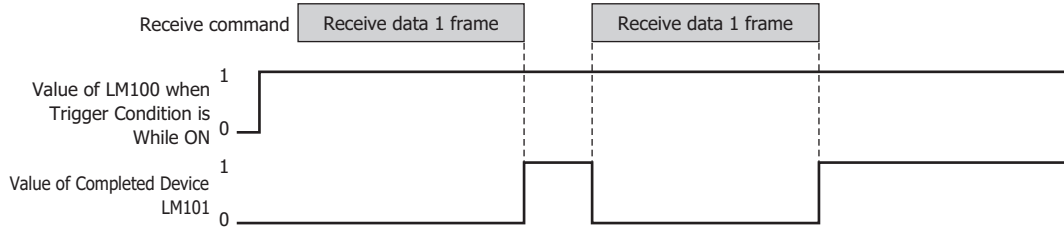

When the **Not Clear Completed Device automatically** check box is selected:

When data receiving is successfully completed, the value of the Completed Device LM101 is set to 1. Even after the first data of the next frame is received, the value of the Completed Device LM101 does not change to 0.

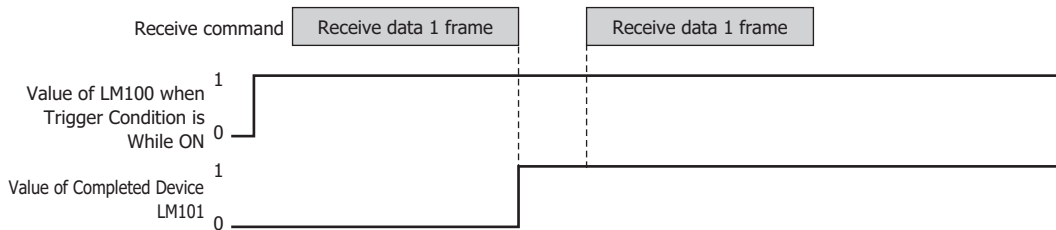

■ Status Device

Specify the destination word device for the transmitted or received data size and error information. Error information and command data size is stored at the beginning of the configured device address. When data transmission or receiving has not successfully completed, the value of each bit changes to 1. The bits of the Status Device changes to 0 when the trigger condition is satisfied and they are not changed to 0 automatically. When **Always Enabled** is selected in **Trigger Condition** of receive command, the value of the Status Device is kept as long as a Clear command is not executed.

You can only specify an internal device.

Click  to display the Device Address Settings dialog box. For the device address configuration procedure, refer to Chapter 2 "5.1 Device Address Settings" on page 2-61.

Example: When LDR110 is configured as **Status Device**

(Starting address) +0 ← Error information and time out information
 +1 ← Transmitted or received data size (bytes)

When **TXD** is selected as **Command Type**:

Address	Bit	Function	Cause	Solution
+0	0	BCC Error	<ul style="list-style-type: none"> The Calculation Start Position and Calculation End Position are not stored in 1 frame. The Calculation End Position is set before Calculation Start Position. 	Change the Calculation Start Position and Calculation End Position settings.
			<ul style="list-style-type: none"> When Calculation Type is Modbus ASCII (LCR), the data size from Calculation Start Position to Calculation End Position is odd bytes. The data contains data other than ASCII (30h to 39h, 41h to 46h) data. 	Change the Calculation Start Position and Calculation End Position settings and the transmission data.
	1, 2	Reserved		
	3	Registering Constant Data Error	When data type is Registering Constant (Character) or Registering Constant (Hexadecimal) , the value of the Index Device does not match the Index No. of the registered Registering Constant.	Change the data stored in the Index Device.
	4	Reserved		
	5	Use Reference Device Data Error	When data type is Device and the Use Reference check box is selected, the device address in which the value of the Reference Device is stored as offset has exceeded the valid range.	Change the value stored in the Reference Device.
	6	Device Data Variable Specification Error	When data type is Device , the Variable check box is selected and Device is selected, the value of device is negative or exceeds the setting (number of bytes x number of words).	Change the value of device to a positive value or to a value that does not exceed the setting (number of bytes x number of words).
	7	Transmission Command Abandon Error	When transmitting data after the Trigger Condition is satisfied, the command with the same Command No. was transmitting data or transmission (transmission is not completed).	Increase the time interval for starting transmission.
8 to 15	Reserved			

Address	Function	Description
+1	Transmission Data Size (bytes)	Stores the size of transmission data.



When the Error Information bit changes to 1, data is not transmitted, and the Transmission Completed Device does not change to 1.

When **RXD** is selected as **Command Type**:

Address	Bit	Function	Cause	Solution
+0	0	BCC error	The BCC that calculated the receive data did not match the BCC that is appended to the receive data.	Check the transmission data from the external device.
			<ul style="list-style-type: none"> The Calculation Start Position and Calculation End Position are not stored in 1 frame. The Calculation End Position is set before Calculation Start Position. 	Change the Calculation Start Position and Calculation End Position settings.
			<ul style="list-style-type: none"> When Calculation Type is Modbus ASCII (LCR), the data size from Calculation Start Position to Calculation End Position is odd bytes. The data contains data other than ASCII (30h to 39h, 41h to 46h) data. 	Change the Calculation Start Position and Calculation End Position settings and the transmission data from the external device.
	1	Received Data Size Error	<ul style="list-style-type: none"> When data type is Device and the Variable check box is selected, 1 frame of process is completed before one of Constant (Character), Constant (Hexadecimal), Registering Constant (Character), Registering Constant (Hexadecimal), BCC, or Skip is processed. When data type is Device and the Variable check box is not selected, the receive data size of the receive data does not match that of the specified receive command. 	Check the transmission data from the external device.
	2	Registering Constant Data Error	The Constant (Character) or Constant (Hexadecimal) set up with the receive command does not match the receive data.	Check the transmission data from the external device.
	3	Registering Constant Error	No data matches the registered setting of the Registering Constant data.	Check the transmission data from the external device.
	4	Device Data Conversion Error	<ul style="list-style-type: none"> When data type is Device and Conversion Type is ASCII (HEX) to Binary, a code other than 0 to 9 or A to F, a to f^{*1} receives as data. When data type is Device and Conversion Type is ASCII (DEC) to Binary, a code other than 0 to 9 receives as data. Or the converted data exceeds 65535. 	Check the transmission data from the external device.
	5	Device Data Reference Device Error	When data type is Device and the Use Reference check box is selected, the device address in which the value of the Reference Device is stored as offset has exceeded the valid range. Or the number of words setting of the device is beyond the range of device address for which data is stored.	Change the value of the Reference Device or the change the number of words.
	6	Terminal Code of Receive Data Mismatch Error	In the receive command whose trigger condition is being satisfied, the start code matches while the terminal code does not match.	Check the transmission data from the external device.
	7	Device Storing Error	In the multiple Receive (RXD) Commands processing, the number of the same-time stored devices which is sum of the number of the stored device of Device and the number of the index device of Registering Constant (Character) or Registering Constant (Hexadecimal) , is over 800 words.	Change settings so that the total number of devices used for storage at one time does not exceed 800 words. Change settings so that the trigger conditions for several receive commands are not satisfied, to reduce the number of receive commands that are processed.
8 to 13	Reserved			
14	Receiving Time Out	1 frame of data is not received even when the preset Receiving Time Out duration has passed after the Trigger Condition is satisfied.	Check the transmission data from the external device.	
15	Receiving Character Time Out	While 1 frame of data is being received, even after the time out period—the specified time interval between receiving data (from when 1 frame of data has been received to when the next frame of data starts to be received)—has elapsed, the next frame of data does not start to be received.	Check the transmission data from the external device.	
Address	Function	Description		
+1	Receive Data Size (bytes)	Stores the size of receive data.		



After the Receiving Character Time Out duration has elapsed, the receive data is analyzed. When the Error Information bit changes to 1, data is not received, and the Receiving Completed Device does not change to 1.

*1 Receive **a** to **f** and device data conversion error occurs if the system-soft version is V4.01 or older. For details, refer to "6.2 Target Information Dialog Box" on page 23-29.

■ Transmission Wait (x100 msec)

Specify the wait time (0 to 255) from when the trigger condition is satisfied to when the data is transmitted. This can be configured only when **TXD** is selected in **Command Type** on the Command Settings dialog box.

After the Transmission Wait duration has elapsed from when the trigger condition is satisfied, transmission starts.

Example: When **Trigger Type** in **Trigger Condition** is **Rising-edge** and **Device** is LM100

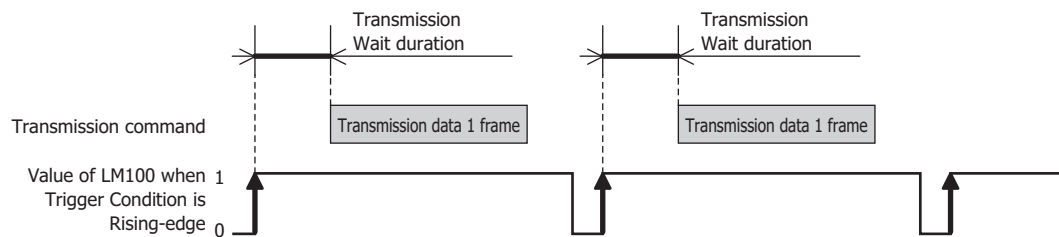

■ Receiving Time Out (x100 msec)

Set the time out (0 to 255) from when the trigger condition is satisfied to when 1 frame of data has been received. A frame refers to a data string from the beginning to the end of a command. If the Receiving Character Time Out is set to 0, it is not monitored.

This can be configured only when **RXD** is selected in **Command Type**, and **While ON**, **While OFF**, or **While satisfying the condition** is selected in **Trigger Type**.

When 1 frame of data could not be received, even though the Receiving Time Out duration has elapsed from when the trigger condition is satisfied, the value of the Receiving Time Out of the Status Device (address+0, bit 14) changes to 1. When the Receiving Time Out duration elapses, the value of the Completed Device does not change to 1, and the receive data is not processed.

When the trigger condition again changes from not satisfied to satisfied, the value of the Receiving Time Out of the Status Device (address+0, bit 14) changes to 0. When the value of this bit is not 0, the Receiving Time Out cannot be detected.

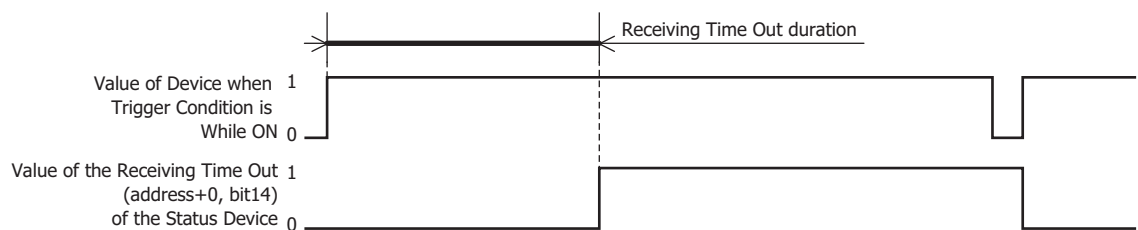

Example: When **Trigger Type** in **Trigger Condition** is **While ON**, **Device** is LM100, **Status Device** is LDR110, **Completed Device** is LM101 and the **Not Clear Completed Device automatically** check box is not selected

When **Status Device** is LDR110, error information and time out information is stored in each bit of LDR110.

When receiving of 1 frame of data is completed before the Receiving Time Out duration has elapsed from when the trigger condition is satisfied, the value of the Receiving Time Out of the Status Device LDR110 (address+0, bit 14) remains 0.

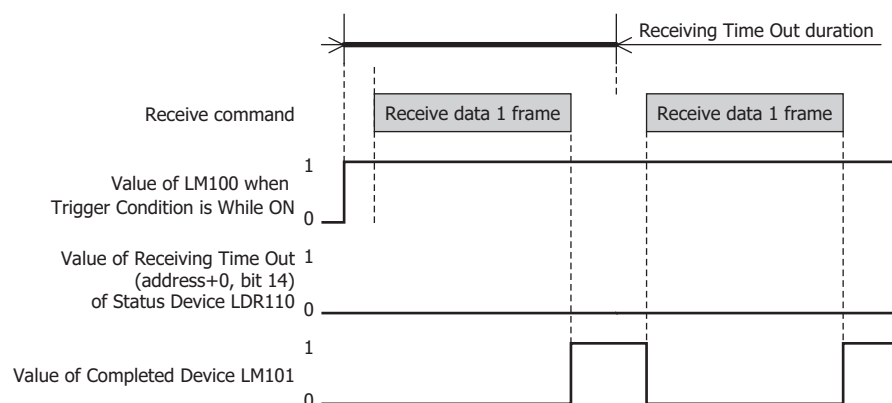

When receiving of 1 frame of data could not be completed by the time the Receiving Time Out duration elapses from when the trigger condition is satisfied, the value of the Receiving Time Out of the Status Device LDR110 (address+0, bit 14) changes to 1.

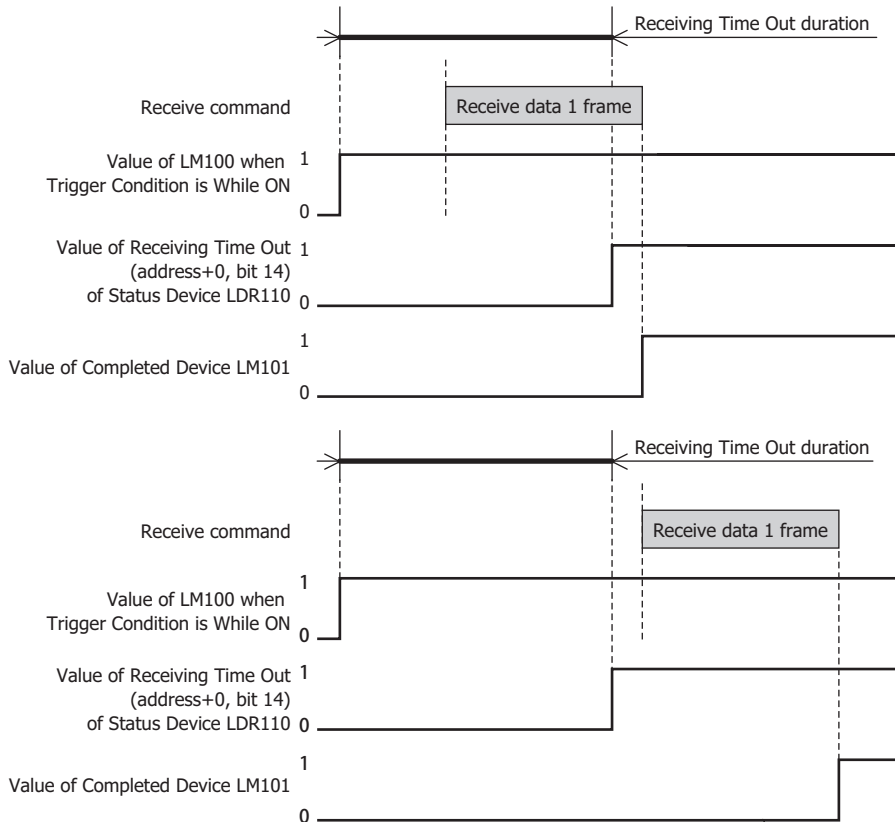

Trigger Condition

Set the trigger conditions for transmission or receiving of data.

When **TXD** is selected as **Command Type**:

Trigger Type: A condition for data transmission is selected from the following.

Rising-edge: Data is transmitted when the value of device changes from 0 to 1.

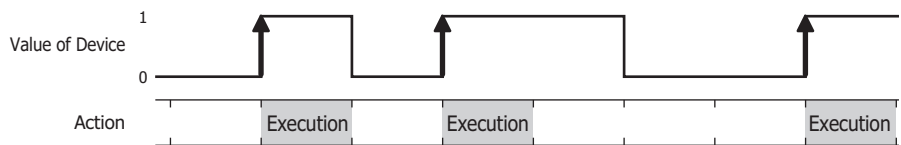

Falling-edge: Data is transmitted when the value of device changes from 1 to 0.

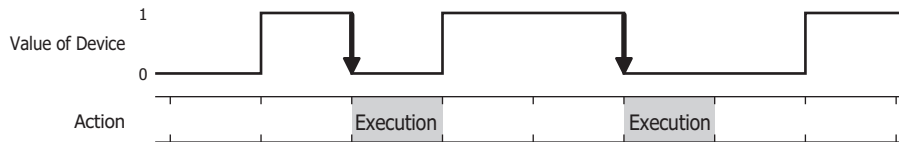

Satisfy the condition:

Data is transmitted when the condition changes from not satisfied to satisfied.

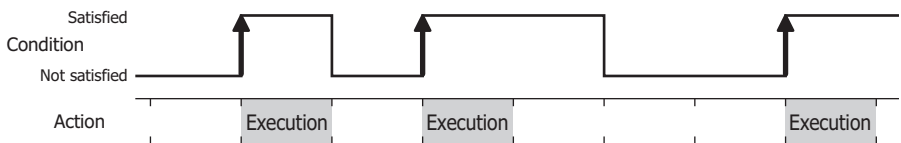

Fixed Period: Data is transmitted at a fixed time interval.

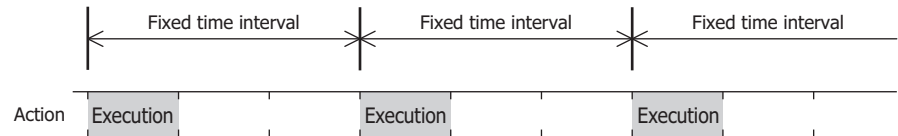

Data Type: Select the data type handled by the conditional expression.

Can only be set if **Satisfy the condition** is selected as **Trigger Type**.

For details, refer to Chapter 2 "1.1 Available Data" on page 2-1.

Device: Specifies the bit device or bit of the word device to serve as condition. You can only specify the HMI device.

Can only be set if **Rising-edge** or **Falling-edge** is selected as **Trigger Type**.

Click to display the Device Address Settings dialog box. For the device address configuration procedure, refer to Chapter 2 "5.1 Device Address Settings" on page 2-61.

Condition: Sets the condition formula.

Can only be set if **Satisfy the condition** is selected as **Trigger Type**.

Click to display the Trigger Condition Settings dialog box. For the conditional expressions configuration procedure, refer to Chapter 2 "5.2 Setting Conditional Expressions" on page 2-63.

Period (sec): Specify the period for command execution from 1 to 3600 (seconds).

This is enabled only when **Fixed Period** is selected in **Trigger Type**.

When **RXD** is selected as **Command Type**:

Trigger Type: Selects the condition to be ready to receive data from the following.

Always Enabled: The Touch is always ready to receive data.



While ON: Ready to receive data when the value of device is 1.

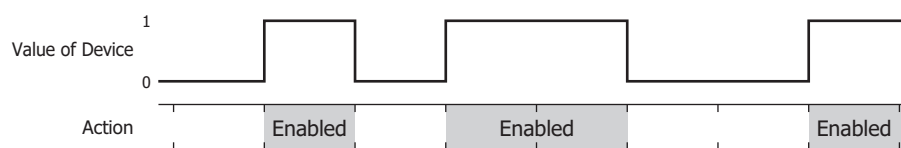

While OFF: Ready to receive data when the value of device is 0.

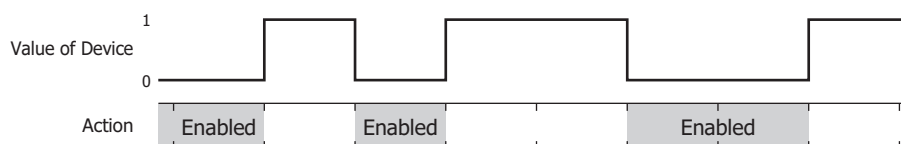

While satisfying the condition:

Ready to receive data while the condition is satisfied.

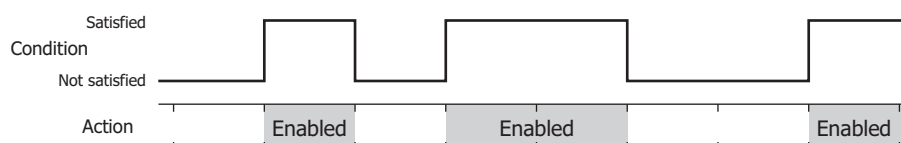

Data Type: Select the data type handled by the conditional expression.

Can only be set if **While satisfying the condition** is selected as **Trigger Type**.

For details, refer to Chapter 2 "1.1 Available Data" on page 2-1.

Device: Specifies the bit device or bit of the word device to serve as condition. You can only specify the HMI device.

Can only be set if **While ON** or **While OFF** is selected as **Trigger Type**.

Click to display the Device Address Settings dialog box. For the device address configuration procedure, refer to Chapter 2 "5.1 Device Address Settings" on page 2-61.

Condition: Sets the condition formula.

Can only be set if **While satisfying the condition** is selected as **Trigger Type**.

Click to display the Trigger Condition Settings dialog box. For the conditional expressions configuration procedure, refer to Chapter 2 "5.2 Setting Conditional Expressions" on page 2-63.

■ Command

Shows a list of command data. Double clicking the line displays the Data Settings dialog box.

For details, refer to "Data Settings Dialog Box" on page 22-36. The maximum amount that can be configured is 32 commands per protocol.

The content displayed in lists varies based on the type of command.

Constant (Character):	Displays the specified data enclosed in " ". "Data" Example: "1234"
Constant (Hexadecimal):	Displays the specified data with each byte value enclosed in ' '. 'Data of the first byte' 'Data of the second byte' 'Data of the third byte' 'Data of the forth byte' Example: '31' '32' '33' '34'
Device:	Displays the specified data enclosed by < >, in the following order. <Device Conversion Type Number of bytes Variable Words Storage Method of data> Device: Displays the device address enclosed by [] When the Use Reference Device check box is selected, displays as OFFSET([Device], [Reference Device]) Number of bytes: Displays the number of bytes of the transmitted or received data. Conversion Type: Display the conversion methods for values of devices as follows. B16-A: When Binary (HEX) to ASCII is selected B10-A: When Binary (DEC) to ASCII is selected N: When No Conversion is selected Variable: When the Variable check box is selected, variables are displayed as follows. V00: When NULL (00h) is selected for transmission command V [Device]: When Device is selected for transmission command V: In the case of receive command Words: Displays the number of word devices for transmitting or receiving data. Storage Method of data: Displays the handling method for value of read device as follows. U: When from Upper byte is selected L: When from Lower byte is selected

Example: <OFFSET([LDR0100], [LDR0300]) N 2V[LDR0200] 2 U>

Registering Constant (Character):

Displays the specified data enclosed in << >>.

<<Index No. of No. 1: Data of No. 1 Index No. of No. 2: Data of No. 2 ... Index No. of No. N: Data of No. N Index Device>> (N = 1 to 100)

Data: Displays the data enclosed by " "

Index Device: Displays the device address enclosed by []

Example: <<1:"123" 2 : "456" 3 : "789" [LDR0100]>>

Registering Constant (Hexadecimal):

Displays the specified data enclosed in << >>.

<<Index No. of No. 1: Data of No. 1 Index No. of No. 2: Data of No. 2 ... Index No. of No. N: Data of No. N Index Device>> (N = 1 to 100)

Data: Displays the data enclosed by ' '

Index Device: Displays the device address enclosed by []

Example: <<1:'313233' 2:'343536' 3 : '373839' [LDR0100]>>

BCC: Displays the specified data enclosed in BCC ().
 BCC(Calculation Start Position Calculation End Position Calculation Type
 Conversion Type Number of bytes)
 Calculation Start Position: Displays the data position where the BCC calculation starts.
 Calculation End Position: Displays the data position where the BCC calculation ends.
 Calculation Type: Display the methods to calculate the data between the Calculation Start Position and Calculation End Position as follows.
 XOR: When **XOR** is selected
 ADD: When **ADD** is selected
 ADD2: When **ADD (2's Complement)** is selected
 Conversion Type: Display the conversion methods for values of devices as follows.
 B16-A: When **Binary (HEX) to ASCII** is selected
 N: When **No Conversion** is selected
 Number of bytes: Displays the number of bytes of the transmitted or received data.

Example: BCC(2 1 XOR N 2)

Skip: Displays the specified data enclosed in Skip().
 Skip(Number of bytes)
 Example: Skip(2)

Edit Add or change data.

To add data, select an empty line in the Command, and then click this button. To change data, select data in the Command, and then click this button. For details, refer to "Data Settings Dialog Box" on page 22-36.

Insert Insert data at the position of the selected command.

Click this button to display the Data Settings dialog box. And specify the data. The data at the insertion point shifts down by 1 item. When 32 data items are already set, you cannot insert data.

Delete Deletes the selected data.

Up Shifts the selected data upward in the command.

Down Shifts the selected data downward in the command.

■ Command Size

Displays the data size of a configured command.

The calculation method for command size varies based on the type selected in **Command Type** on the Command Settings dialog box. The command size calculation methods are as follows.

TXD: Number of bytes for Constant Data + Number of bytes for a data of Registering Constant + Number of bytes of BCC + Number of bytes of Device x Words of Device

RXD: Number of bytes for Constant Data + Number of bytes for a data of Registering Constant + Number of bytes of BCC + Number of bytes of Skip + Number of bytes of Device x Words of Device

■ OK

Save the settings.

■ Cancel

Cancel the saving of settings.

- Data Settings Dialog Box

Specify the transmitted or received data by a command.

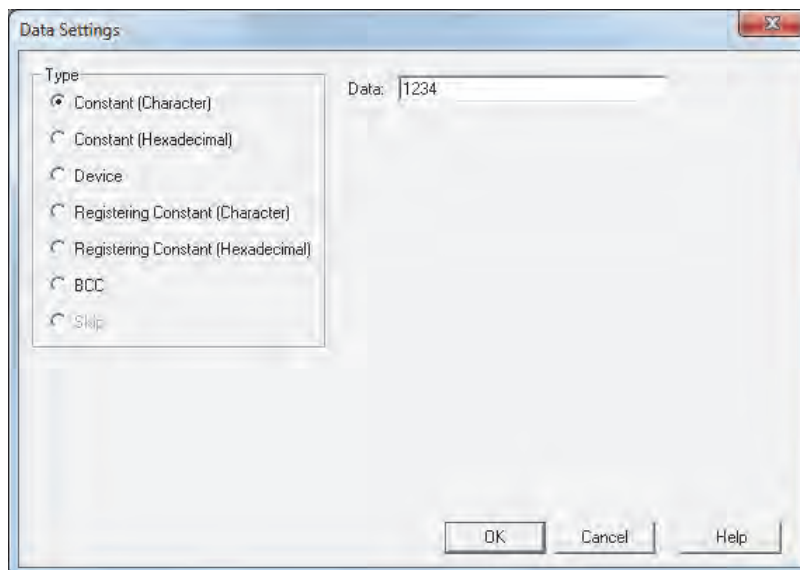

- **Type**

Selects data types from the following items.

Constant (Character), Constant (Hexadecimal), Device, Registering Constant (Character), Registering Constant (Hexadecimal), BCC, Skip

Skip can only be configured when **RXD** is selected in **Command Type** on the Command Settings dialog box.

Setting item varies based on the selection in **Command Type** on the Command Settings dialog box.

When **TXD** is selected, refer to "Transmission (TXD) Command" on page 22-37.

When **RXD** is selected, refer to "Receive (RXD) Command" on page 22-50.

● Transmission (TXD) Command

Constant (Character)

The character data is sent without being converted.

This can be configured only when **TXD** is selected in **Command Type** on the Command Settings dialog box, and **Constant (Character)** is selected under **Type** on the Data Settings dialog box.

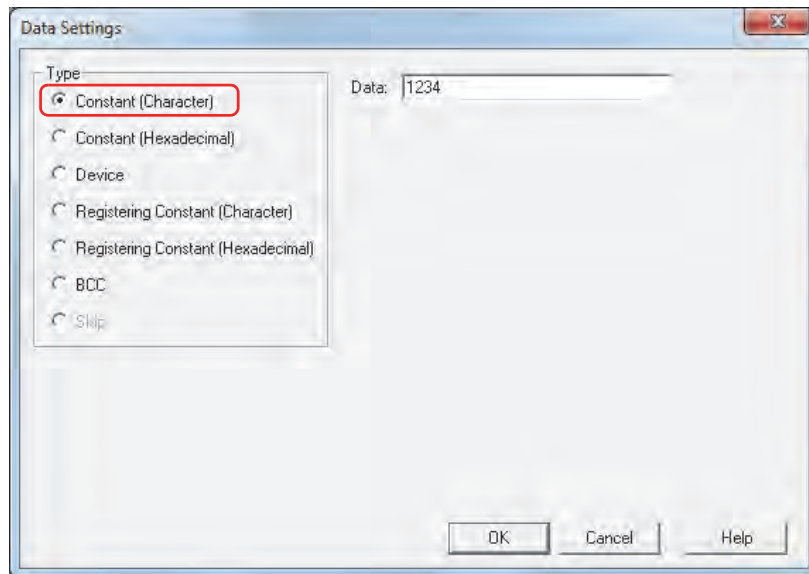

■ Data

Enter character data (1 to 1500 bytes) to be transmitted. The size of a single-byte character is one byte and that of a double-byte character is two bytes.

Example: Constant (Character) for transmission command data

Item	Setting
Data	1234

When the trigger condition is satisfied, the character data is transmitted in the following order.

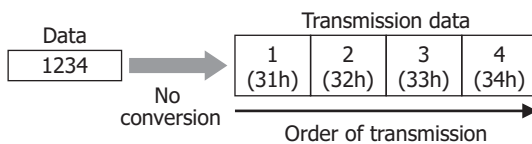

Constant (Hexadecimal)

The hexadecimal data is sent without being converted.

Use this setting to send a control code of ASCII data (00h to 1Fh).

This can be configured only when **TXD** is selected in **Command Type** on the Command Settings dialog box, and **Constant (Hexadecimal)** is selected under **Type** on the Data Settings dialog box.

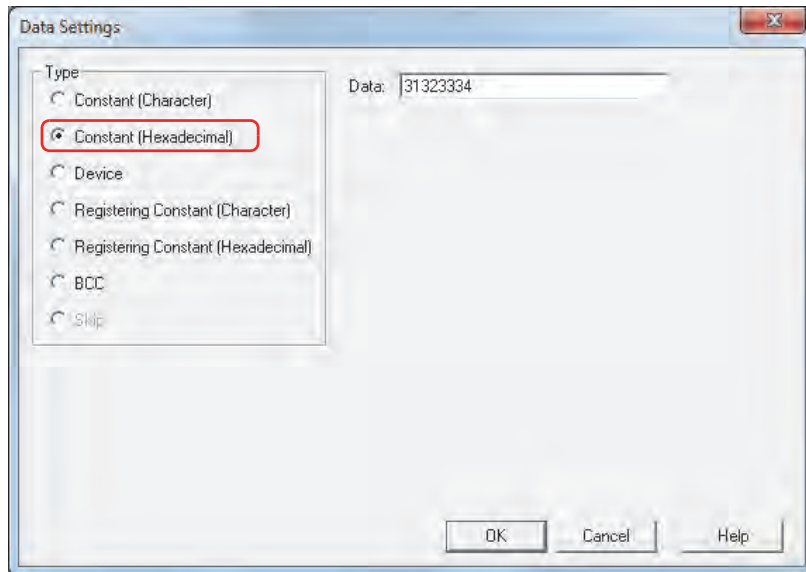

■ **Data**

Enter hexadecimal data (1 to 1500 bytes) to be transmitted.

Example: Constant (Hexadecimal) for transmission command data

Item	Setting
Data	1234

When the trigger condition is satisfied, 1234h is transmitted in the order 12h and 34h.

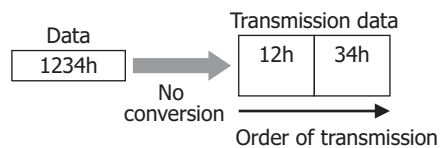

Device

The value of device is either not converted or converted to ASCII and then sent as data with the specified size. This can be configured only when **TXD** is selected in **Command Type** on the Command Settings dialog box, and **Device** is selected under **Type** on the Data Settings dialog box.

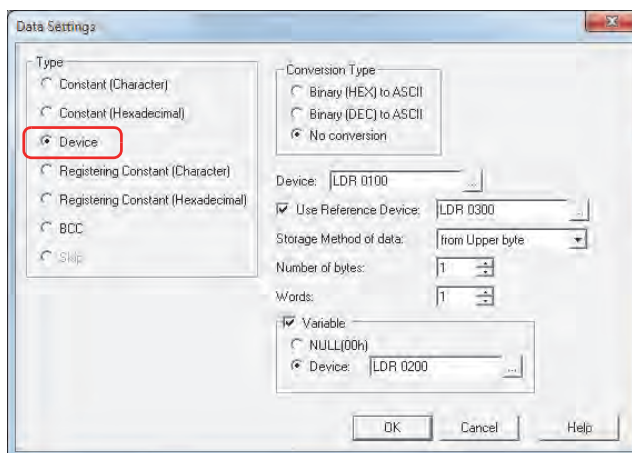

■ Conversion Type:

Select the conversion rule for the value of device from the following.

Binary (HEX) to ASCII: Considers the value of device as binary-coded hexadecimal number and converts it to ASCII data.

Binary (DEC) to ASCII: Considers the value of device as binary-coded decimal number and converts it to ASCII data.

No Conversion: No conversion is performed.

■ Device

Specify the source word device for transmitted data. You can only specify an internal device.

Click to display the Device Address Settings dialog box. For the device address configuration procedure, refer to Chapter 2 "5.1 Device Address Settings" on page 2-61.

■ Use Reference Device

To change the source word device for transmitted data according to values of device, select this check box and specify a device. This can be configured only when **No Conversion** is selected under **Conversion Type**. You can only specify an internal device.

For details, refer to Chapter 2 "Indirect Read and Indirect Write Settings" on page 2-4.

Click to display the Device Address Settings dialog box. For the device address configuration procedure, refer to Chapter 2 "5.1 Device Address Settings" on page 2-61.

■ Storage Method of data

Select the handling method for the value of read device. This can be configured only when **No Conversion** is selected under **Conversion Type**.

from Upper byte: Value of devices are read from the upper byte.

from Lower byte: Value of devices are read from the lower byte.

■ Number of bytes

Specify the number of bytes of transmitted data. The number of bytes that can be specified varies based on the setting under **Conversion Type**.

Binary (HEX) to ASCII: 1 to 4

Binary (DEC) to ASCII: 1 to 5

No Conversion: 1 to 2

■ Words

Specify the number of word devices (1 to 99) of transmitted data.

Variable

Select this check box to change the transmitted data size according to conditions. This can be configured only when **No Conversion** is selected under **Conversion Type**. When the check box is not selected, the amount of data (bytes) transmitted is data (bytes) for Number of bytes x Words.

NULL (00h): Send the data from the start data of the value of device up to 00 (hexadecimal). Data 00 will not be sent. This setting is effective for sending only the character data section of character data having 00 (hexadecimal) as the last data.

Device: Specify a word device to which a number of bytes is applied for transmitted data.
 Click to display the Device Address Settings dialog box. For the device address configuration procedure, refer to Chapter 2 "5.1 Device Address Settings" on page 2-61.
 When the value of device exceeds Number of bytes x Words, or when it is negative, the Device Data Variable Specification Error (address+0, bit 6) of the Status Device changes to 1, and transmission does not occur.

Examples: Device for transmission command data

Example 1

Item	Setting
Conversion Type	No Conversion
Device	LDR100
Use Reference Device	OFF
Storage Method of data	from Upper byte
Number of bytes	1
Words	3
Variable	OFF

When the trigger condition is satisfied, the value of device is read and data is transmitted in the following order.

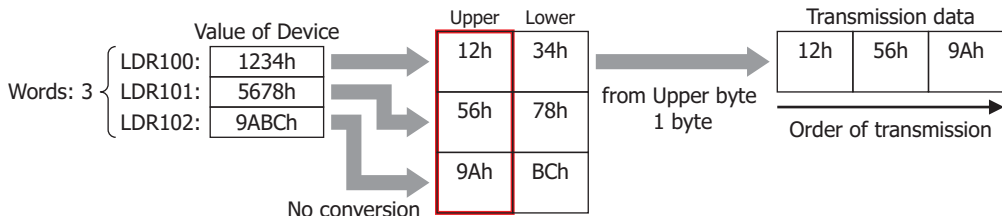

Example 2

Item	Setting
Conversion Type	No Conversion
Device	LDR100
Use Reference Device	OFF
Storage Method of data	from Lower byte
Number of bytes	2
Words	3
Variable	OFF

When the trigger condition is satisfied, the value of device is read and data is transmitted in the following order.

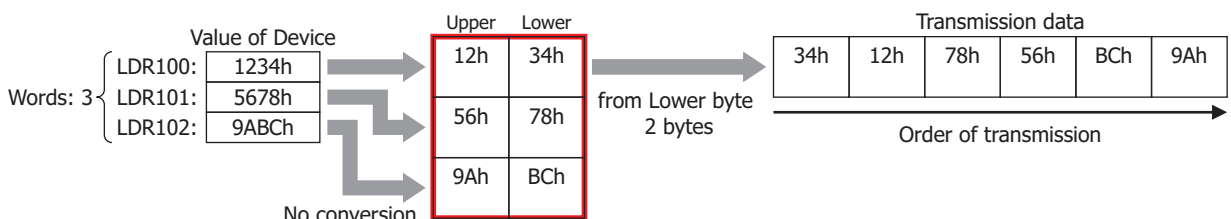

Example 3

Item	Setting
Conversion Type	Binary (HEX) to ASCII
Device	LDR100
Use Reference Device	OFF
Number of bytes	2
Words	2
Variable	OFF

When the trigger condition is satisfied, the value of device is read, and data is converted to ASCII and transmitted in the following order.

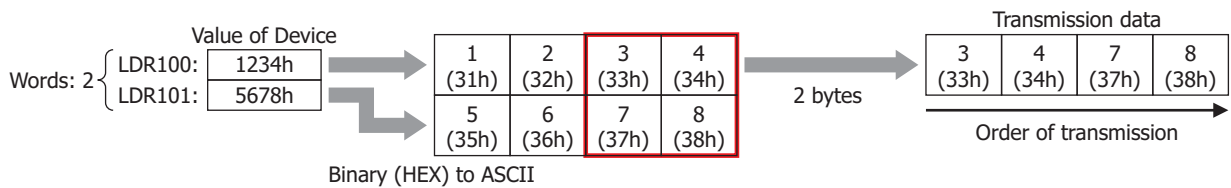
**Example 4**

Item	Setting
Conversion Type	Binary (DEC) to ASCII
Device	LDR100
Use Reference Device	OFF
Number of bytes	2
Words	2
Variable	OFF

When the trigger condition is satisfied, the value of device is read, and data is converted to ASCII and transmitted in the following order.

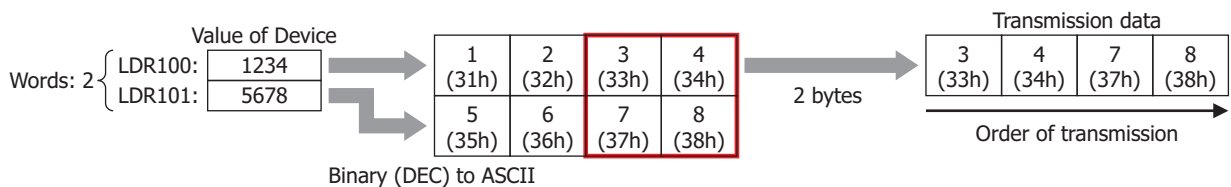
**Example 5**

Item	Setting
Conversion Type	No Conversion
Device	LDR100
Use Reference Device	OFF
Storage Method of data	from Upper byte
Number of bytes	2
Words	2
Variable	ON, NULL

When the trigger condition is satisfied, the value of device is read and data is transmitted in the following order.

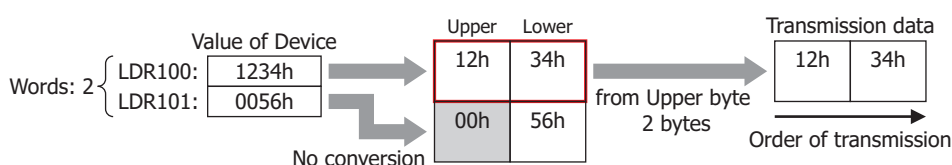

Example 6

Item	Setting
Conversion Type	No Conversion
Device	LDR100
Use Reference Device	OFF
Storage Method of data	from Lower byte
Number of bytes	2
Words	2
Variable	ON, Device: LDR200

When the trigger condition is satisfied, the value of device is read and data is transmitted in the following order.
 When the LDR200 value is 3

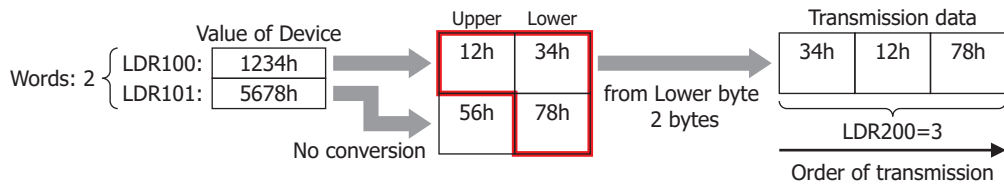

Example 7

Item	Setting
Conversion Type	No Conversion
Device	LDR100
Use Reference Device	ON, Device: LDR200
Storage Method of data	from Upper byte
Words	2
Variable	OFF

When the trigger condition is satisfied, the value of device is read and data is transmitted in the following order.
 When the LDR200 value is 2

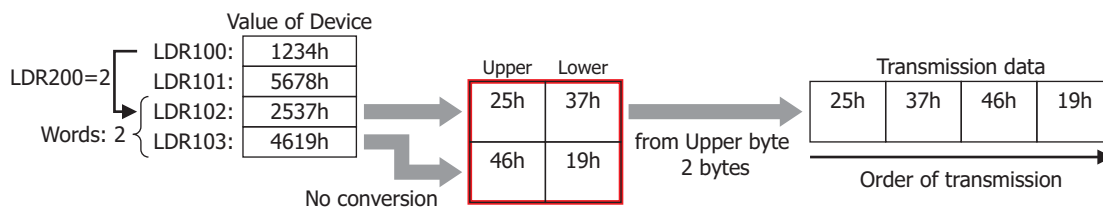

Registering Constant (Character)

From the registered character data, character data according to the value of device is read and transmitted.

This can be configured only when **TXD** is selected in **Command Type** on the Command Settings dialog box, and **Registering Constant (Character)** is selected under **Type** on the Data Settings dialog box.

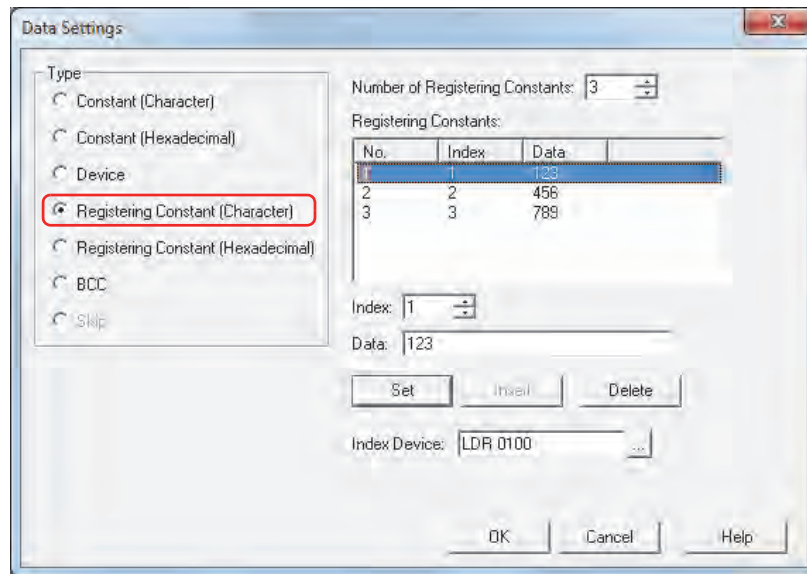

■ Number of Registering Constants

Specify the number of data of the registered character data (1 to 100).

■ Registering Constants

No.: Shows the ID No. (1 to 100) of the character data.

Index: Shows the Index No. of the character data.

Data: Shows the character data.

■ Index

Specify the Index No. (0 to 65535) of the character data.

■ Data

Enter the character data (1 to 1500 bytes) to be registered. The size of a single-byte character is one byte and that of a double-byte character is two bytes.

The character data of different size or the same data with a different number cannot be registered.

■ Set

Register the **Index** and **Data** settings to the list. When a number that is already registered is selected, it is overwritten with the new setting.

■ Insert

Insert a character data setting to the selected number in the list.

Click this button to insert the **Index** and **Data** setting. The settings at the insertion point shift down 1 line. Settings cannot be inserted when all numbers are already set.

■ Delete

Delete the selected settings from the list.

■ Index Device

Specify the source word device to serve as the Index No. You can only specify an internal device.

Click to display the Device Address Settings dialog box. For the device address configuration procedure, refer to Chapter 2 "5.1 Device Address Settings" on page 2-61.

Example: Transmission command for Registering Constant (Character) data

Item	Setting
Number of Registering Constants	3
Registering Constants	Index No. 1: 123
	Index No. 2: 456
	Index No. 3: 789
Index Device	LDR100

When the trigger condition is satisfied, the data of the Index No. according to the value of device is transmitted.

When the LDR100 value is 2

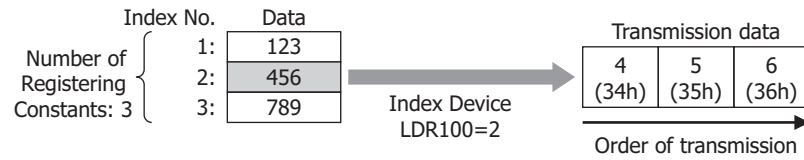

Registering Constant (Hexadecimal)

From the registered hexadecimal data, the hexadecimal data according to the value of device is read and transmitted. This can be configured only when **TXD** is selected in **Command Type** on the Command Settings dialog box, and **Registering Constant (Hexadecimal)** is selected under **Type** on the Data Settings dialog box.

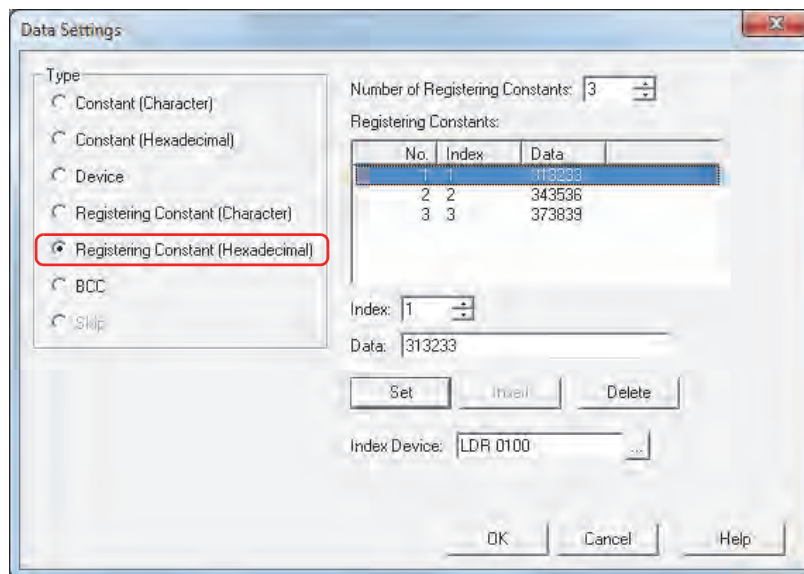

■ Number of Registering Constants

Specify the number of data of the registered hexadecimal data (1 to 100).

■ Registering Constants

No.: Shows the ID No. (1 to 100) of the hexadecimal data.

Index: Shows the Index No. of the hexadecimal data.

Data: Shows the hexadecimal data.

■ Index

Specify the Index No. (0 to 65535) of the hexadecimal data.

■ Data

Enter the hexadecimal data (1 to 1500 bytes) to be registered.

The data of different size or the same data with a different number cannot be registered.

■ Set

Register the **Index** and **Data** settings to the list. When a number that is already registered is selected, it is overwritten with the new setting.

■ Insert

Insert a hexadecimal data setting to the selected number in the list.

Click this button to insert the **Index** and **Data** setting. The settings at the insertion point shift down one line. Settings cannot be inserted when all numbers are already set.

■ Delete

Delete the selected settings from the list.

■ Index Device

Specify the source word device to serve as the Index No. You can only specify an internal device.

Click  to display the Device Address Settings dialog box. For the device address configuration procedure, refer to Chapter 2 "5.1 Device Address Settings" on page 2-61.

Example: Transmission command for Registering Constant (Hexadecimal) data

Item	Setting
Number of Registering Constants	3
Registering Constants	Index No. 1: 1234
	Index No. 2: 5678
	Index No. 3: 2537
Index Device	LDR100

When the trigger condition is satisfied, the data of the Index No. according to the value of device is transmitted.

When the LDR100 value is 3

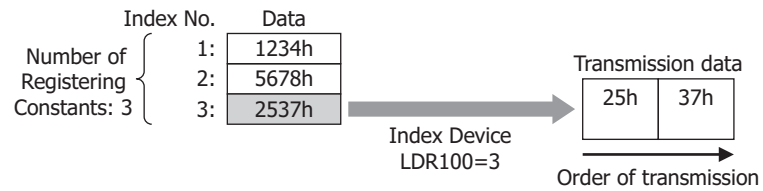

BCC (Block Check Code)

A BCC for the transmission data is automatically calculated and appended to the transmission data at an arbitrary position and transmitted.

This can be configured only when **TXD** is selected in **Command Type** on the Command Settings dialog box, and **BCC** is selected under **Type** on the Data Settings dialog box.

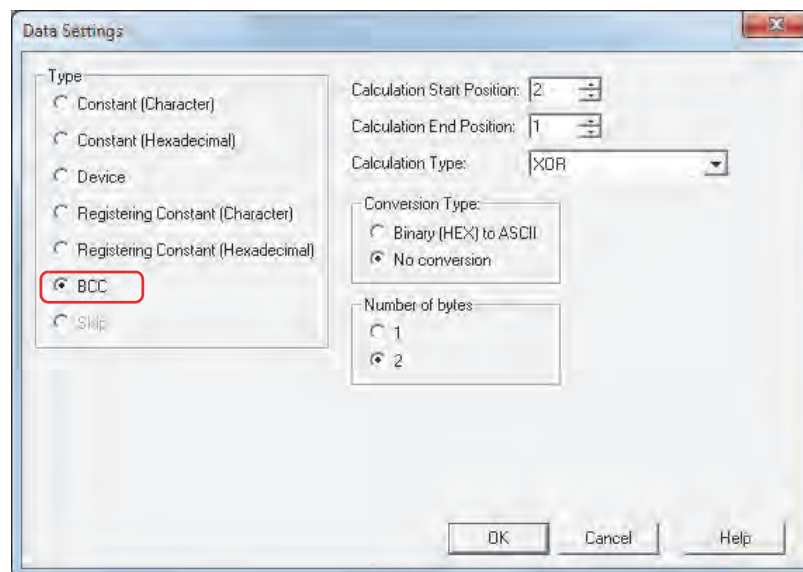

■ Calculation Start Position

Specify the position of transmission data at which BCC calculation starts (1 to 15). The position is counted backwards, with the first position of the transmission data taken as 1.

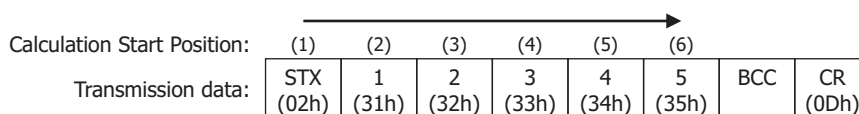

■ Calculation End Position

Specify the position of transmission data at which BCC calculation ends (0 to 15). The position is counted forwards, with the data position before the BCC taken as 0.

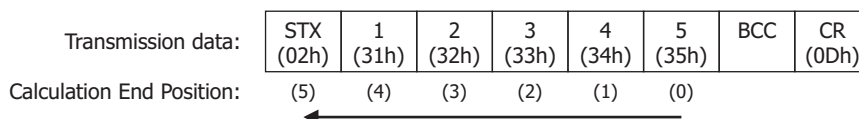

■ Calculation Type

Select the method to calculate the data between the Calculation Start Position and Calculation End Position.

XOR: Calculates the data with exclusive logical add.

ADD: Calculates the data using addition.

ADD (2's Complement): Calculates the data using addition, inverts the bit and adds one.

Modbus ASCII (LCR): Calculation is performed according to the following procedure. Conversion Type: Binary (HEX) to ASCII, Number of bytes: 2

1. Convert the ASCII characters between Calculation Start Position and Calculation End Position into 1-byte hexadecimal data for each set of two characters.
Example: 37h, 35h→75h
2. Calculate the sum of the data obtained in step 1.
3. Invert the bit of the result of step 2 and add one. (2's complement)
4. Convert the lower one byte data of the result of step 3 into ASCII characters.
Example: 75h→37h, 35h

Modbus RTU (CRC): CRC-16 (Generating polynomial: $x^{16} + x^{15} + x^2 + 1$) is calculated according to the following procedure. Conversion Type: No Conversion, Number of bytes: 2

1. Obtain an exclusive OR (XOR) of 1 byte data at Calculation Start Position and FFFFh.
2. If the least significant bit of the result of step 1 is 0, shift to the right by one bit. If the bit is 1, shift to the right by 1 bit and obtain XOR of the result and the value (A001h).
3. Repeat step 2 to shift 8 times.
4. Obtain XOR of the next one byte of data and the result of step 3.
5. Repeat steps 2 through 4 until the data at Calculation End Position is processed.
6. Send the result of step 5 in the order of the lower byte and upper byte.

Example: 1234h → 34h, 12h

■ **Conversion Type**

After calculating the data using the specified calculation type, select the type of conversion for the data from the following.

Binary (HEX) to ASCII Considers the data as binary-coded hexadecimal number and converts it to ASCII data.

No conversion: No conversion is performed.

■ **Number of bytes**

After converting according to the specified conversion type, select **1** or **2** for the number of bytes for transmission data.

Example: BCC for transmission command data

This example describes the case of transmitting the BCC calculation result from the following transmission data as BCC data.

STX (02h)	1 (31h)	2 (32h)	3 (33h)	4 (34h)	5 (35h)	BCC	CR (0Dh)
--------------	------------	------------	------------	------------	------------	-----	-------------

• Calculation Start Position and Calculation End Position

When Calculation Start Position is 2 and Calculation End Position is 1: Calculates the range **1234**.

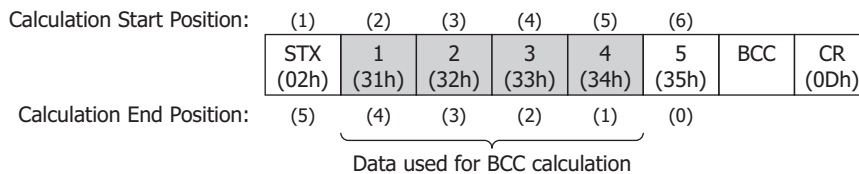

• Calculation Type

- XOR: $31h \wedge 32h \wedge 33h \wedge 34h = 04h$
- ADD: $31h + 32h + 33h + 34h = CAh$
- ADD (2's Complement): Inverts the bit of $CAh + 1 = 36h$
- Modbus ASCII (LCR): **BA** → 42h, 41h
- Modbus RTU (CRC): BA30h → BAh, 30h

• Conversion Type

When the BCC calculation result is **0004h**, the converted data is as follows.

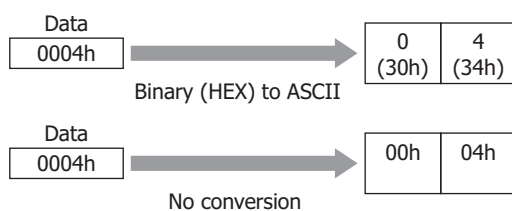

- Bytes and BCC data

When the converted data is **3034h**, the data appended to the transmission data is as follows.

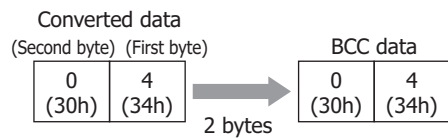
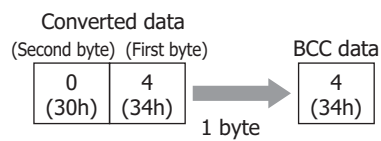

- When Calculation Type is **Modbus ASCII (LCR)**

When the BCC calculation result is **4241h** after **Binary (HEX) to ASCII** conversion the resulting two bytes of data is appended to the transmission data.

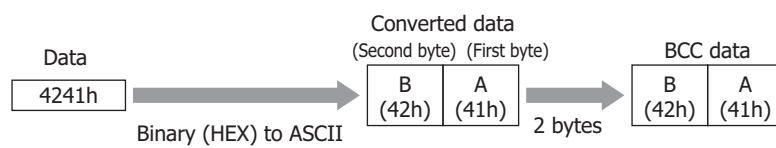

- When Calculation Type is **Modbus RTU (CRC)**

When the BCC calculation result is **BA30h** with no conversion the two bytes of data is appended to the transmission data.

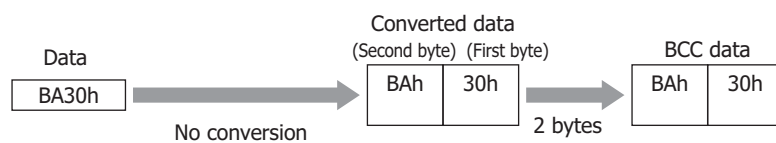

● Receive (RXD) Command

Constant (Character)

The received data is considered as character data and compared with the data specified without being converted. This can be configured only when **RXD** is selected in **Command Type** on the Command Settings dialog box, and **Constant (Character)** is selected under **Type** on the Data Settings dialog box.

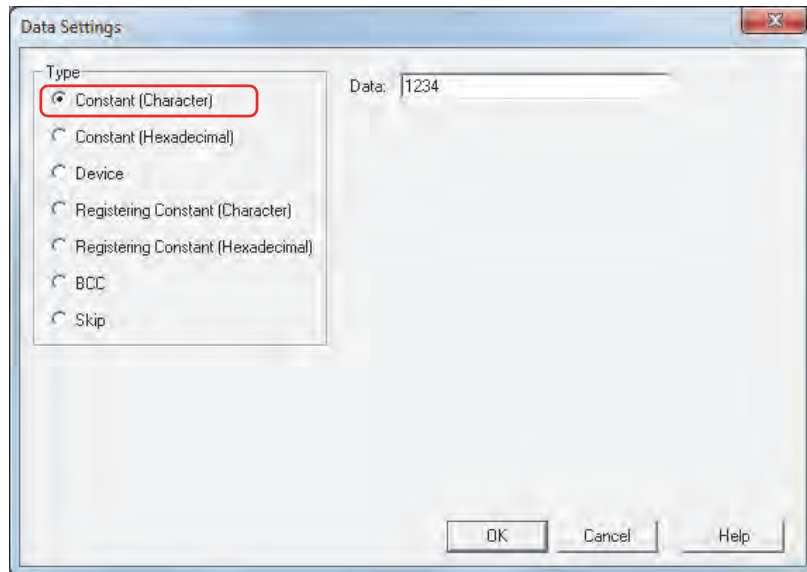

■ Data

Enter character data (1 to 1500 bytes) designated to be received. The size of a single-byte character is one byte and that of a double-byte character is two bytes.



When a Constant (Character) is set at the beginning of a command, the first one byte is recognized as the start code. When a Constant (Character) is set at the end of a command, the last one byte is recognized as the terminal code.

For details, refer to "Start Code and Terminal Code" on page 22-66.

Example: Constant (Character) for receive command data

Item	Setting
Data	1234

When the trigger condition is satisfied, the received data is compared with the following data.

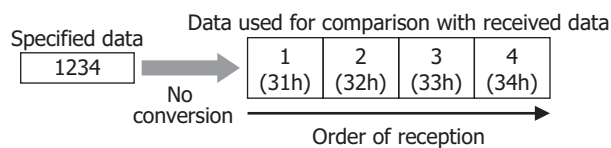

Constant (Hexadecimal)

The received data is considered as hexadecimal data and compared with the data specified without being converted. Use this setting to receive a control code of ASCII data (00h to 1Fh).

This can be configured only when **RXD** is selected in **Command Type** on the Command Settings dialog box, and **Constant (Hexadecimal)** is selected under **Type** on the Data Settings dialog box.

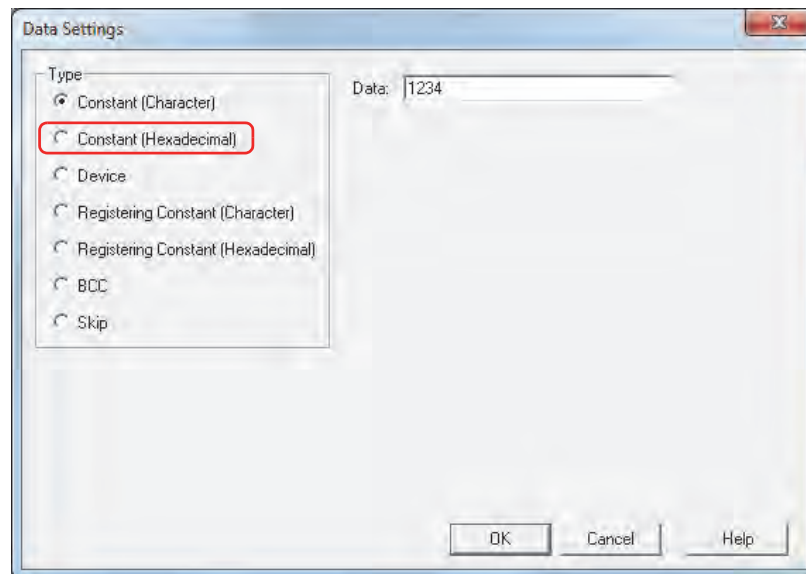

■ Data

Enter hexadecimal data (1 to 1500 bytes) designated to be received.



When a Constant (Character) is set at the beginning of a command, the first one byte is recognized as the start code. When a Constant (Character) is set at the end of a command, the last one byte is recognized as the terminal code.

For details, refer to "Start Code and Terminal Code" on page 22-66.

Example: Constant (Hexadecimal) for receive command data

Item	Setting
Data	1234

When the trigger condition is satisfied, the received data is compared with the following data.

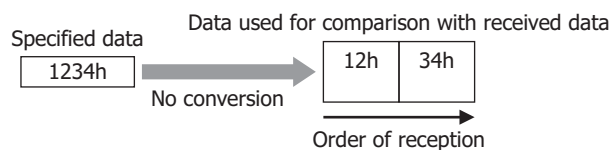

Device

From the received data, data of the specified size is unconverted, or converted to binary format, and stored in the device.

This can be configured only when **RXD** is selected in **Command Type** on the Command Settings dialog box, and **Device** is selected under **Type** on the Data Settings dialog box.

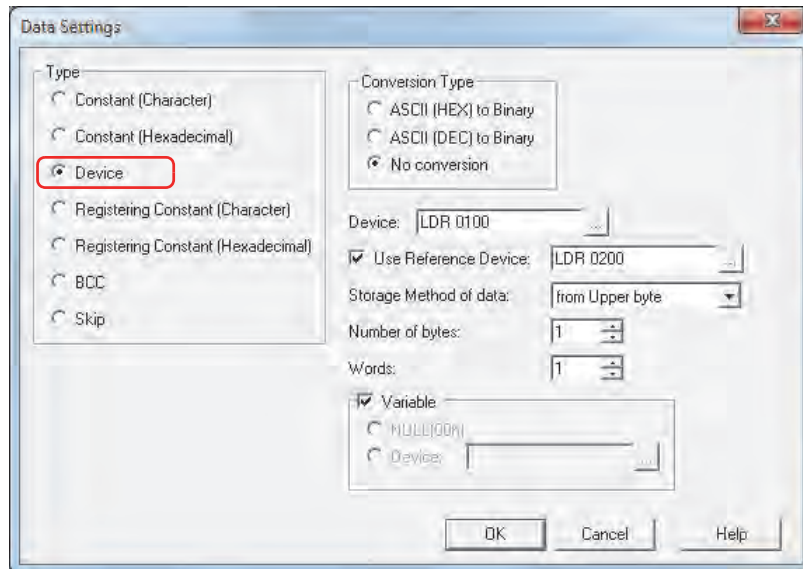

■ Conversion Type

Select conversion processing for the received data from the following.

ASCII (HEX) to Binary: Considers the received data as a hexadecimal number and converts it to binary data.

ASCII (DEC) to Binary: Considers the received data as a decimal number and converts it to binary data.

No conversion: No conversion is performed.

■ Device

Specify the word device for storing the received data. You can only specify an internal device.

Click to display the Device Address Settings dialog box. For the device address configuration procedure, refer to Chapter 2 "5.1 Device Address Settings" on page 2-61 .

■ Use Reference Device

To change the word device for storing the received data according to values of devices, select this check box and specify a device. You can only specify an internal device.

Click to display the Device Address Settings dialog box. For the device address configuration procedure, refer to Chapter 2 "5.1 Device Address Settings" on page 2-61.

■ Storage Method of data

Select the handling method for received data. This can be configured only when **No Conversion** is selected under **Conversion Type**.

from Upper byte: Values of devices are stored from the upper byte.

from Lower byte: Values of devices are stored from the lower byte.

■ Number of bytes

Specify the received data size to be stored per word. The number of bytes to be specified varies based on **Conversion Type**.

ASCII (HEX) to Binary: 1 to 4

ASCII (DEC) to Binary: 1 to 5

No Conversion: 1 to 2

■ Words

Specify the number of word devices (1 to 250) for storing the received data.

Variable

Select this check box to store data up to either **Constant (Character)** data, or **Constant (Hexadecimal)** data from the beginning of the received data in a device. Stores data of the size specified under **Words**. When the stored data is smaller than the size specified under **Words**, the values of all remaining devices will be stored 0.

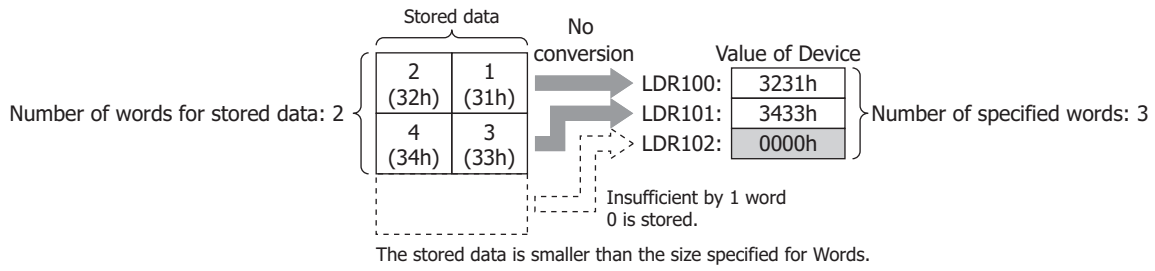

When the check box is not selected, the amount of data (bytes) stored is Number of bytes x Number of words.



When the **Variable** check box is selected, observe the following points.

- When data is set expect for the end of a command, set **Constant (Character)** data or **Constant (Hexadecimal)** data following **Device** data.
- When there is no data stored in the device, all of the values of devices specified under **Words** will be 0.
- The maximum amount of the received data stored in the device is Number of bytes x Number of words.

Examples: Device for receive command data

Example 1

Item	Setting
Conversion Type	No Conversion
Device	LDR100
Use Reference Device	OFF
Storage Method of data	from Upper byte
Number of bytes	1
Words	3
Variable	OFF

When the trigger condition is satisfied, the received data is stored in devices in the following order.

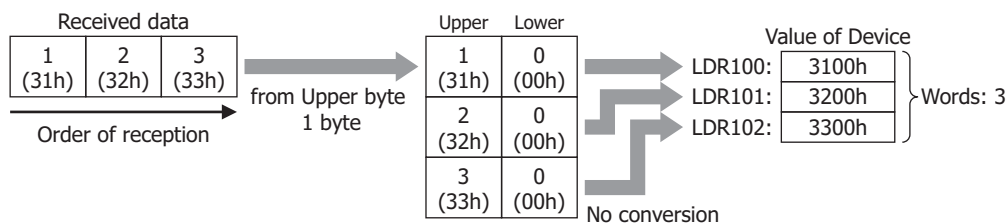

Example 2

Item	Setting
Conversion Type	No Conversion
Device	LDR100
Use Reference Device	OFF
Storage Method of data	from Lower byte
Number of bytes	2
Words	2
Variable	OFF

When the trigger condition is satisfied, the received data is stored in devices in the following order.

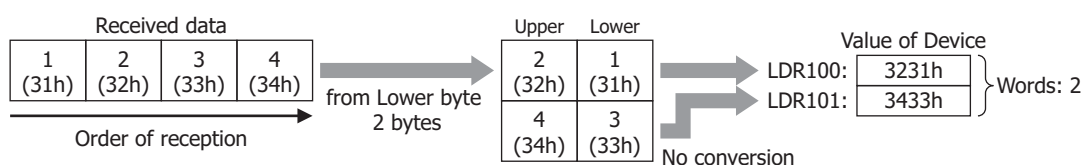

Example 3

Item	Setting
Conversion Type	ASCII (HEX) to Binary
Device	LDR100
Use Reference Device	OFF
Number of bytes	2
Words	2
Variable	OFF

When the trigger condition is satisfied, the received data is stored in devices in the following order.

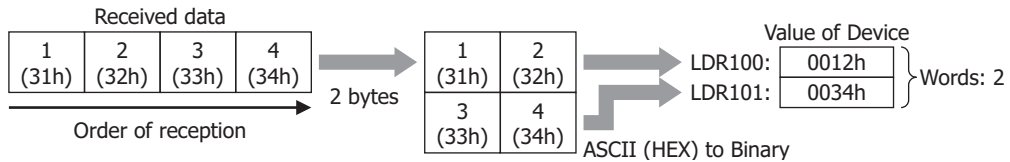

Example 4

Item	Setting
Conversion Type	ASCII (DEC) to Binary
Device	LDR100
Use Reference Device	OFF
Number of bytes	2
Words	2
Variable	OFF

When the trigger condition is satisfied, the received data is stored in devices in the following order.

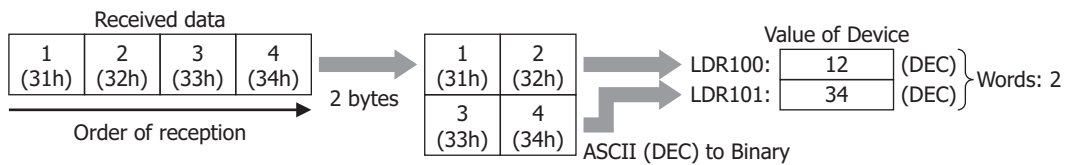

Example 5

Item	Setting
Conversion Type	No Conversion
Device	LDR100
Use Reference Device	OFF
Storage Method of data	from Upper byte
Number of bytes	1
Words	3
Variable	ON

When the trigger condition is satisfied, the received data is stored in devices in the following order.

Data from the beginning of the received data to **Constant (Hexadecimal)** data is stored in the device. **Constant (Hexadecimal)** data is not stored.

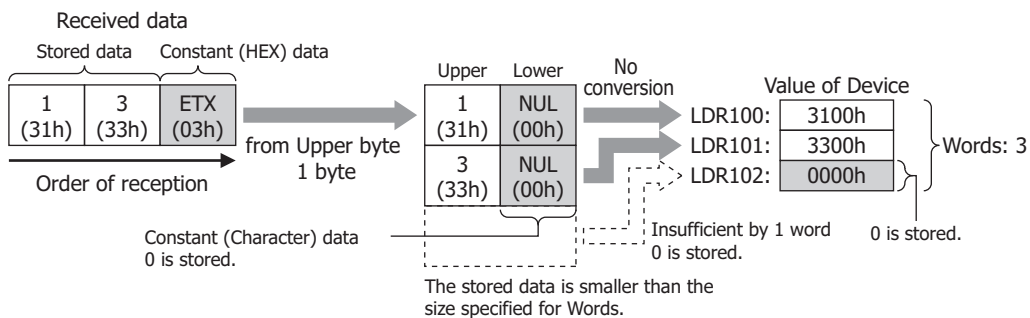

Example 6

Item	Setting
Conversion Type	No Conversion
Device	LDR100
Use Reference Device	OFF
Storage Method of data	from Lower byte
Number of bytes	2
Words	3
Variable	ON

When the trigger condition is satisfied, the received data is stored in devices in the following order.

Data from the beginning of the received data to **Constant (Hexadecimal)** data is stored in the device. **Constant (Hexadecimal)** data is not stored.

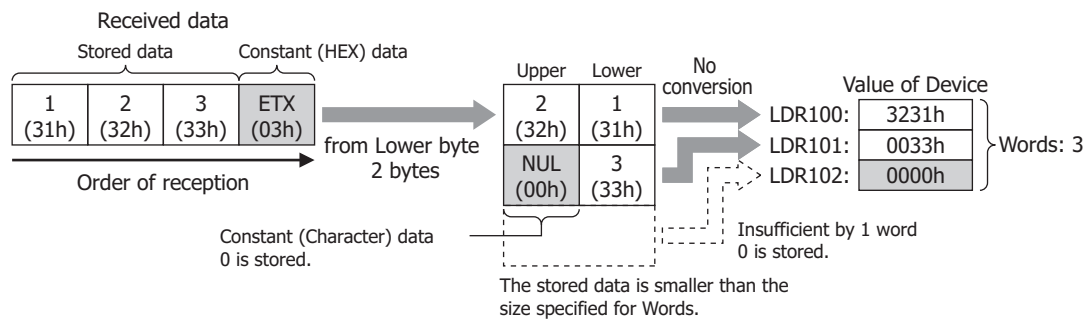
**Example 7**

Item	Setting
Conversion Type	ASCII (HEX) to Binary
Device	LDR100
Use Reference Device	OFF
Number of bytes	1
Words	3
Variable	ON

When the trigger condition is satisfied, the received data is stored in devices in the following order.

Data from the beginning of the received data to **Constant (Hexadecimal)** data is stored in the device. **Constant (Hexadecimal)** data is not stored.

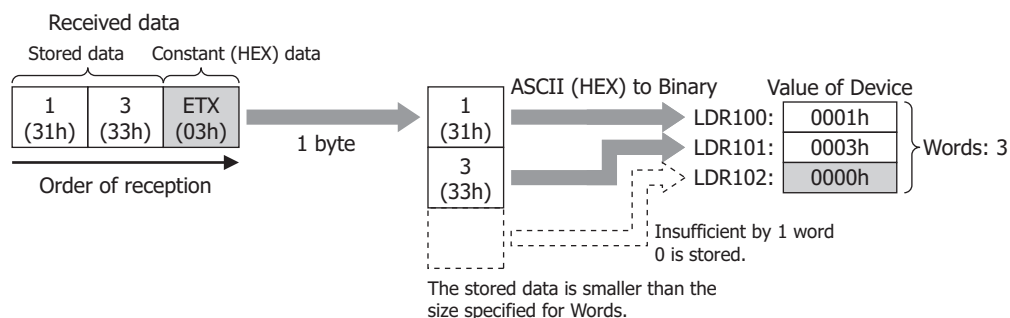

Example 8

Item	Setting
Conversion Type	ASCII (DEC) to Binary
Device	LDR100
Use Reference Device	OFF
Number of bytes	2
Words	3
Variable	ON

When the trigger condition is satisfied, the received data is stored in devices in the following order.

Data from the beginning of the received data to **Constant (Hexadecimal)** data is stored in the device. **Constant (Hexadecimal)** data is not stored.

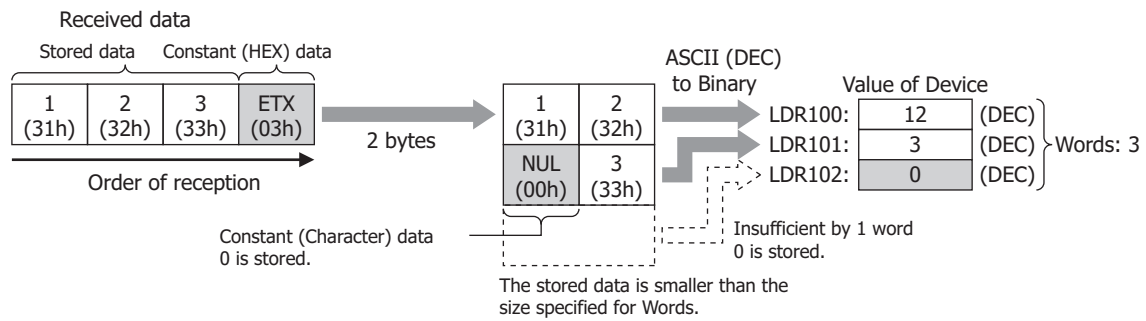

Example 9

Item	Setting
Conversion Type	No Conversion
Device	LDR100
Use Reference Device	ON, Device: LDR200
Storage Method of data	from Upper byte
Words	2
Variable	OFF

When the trigger condition is satisfied, the received data is stored in devices in the following order.

When the LDR200 value is 2

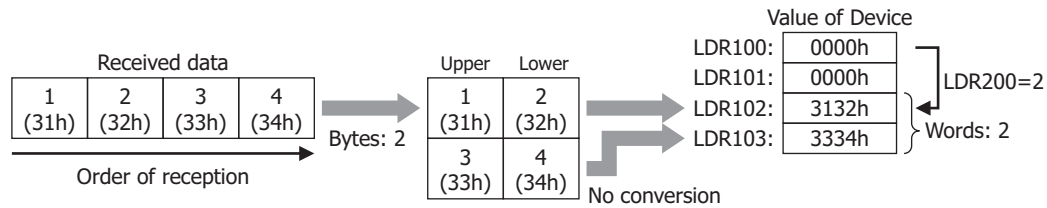

Registering Constant (Character)

The received data is compared with the registered character data and the number of the matching character data is stored in the device.

This can be configured only when **RXD** is selected in **Command Type** on the Command Settings dialog box, and **Registering Constant (Character)** is selected under **Type** on the Data Settings dialog box.

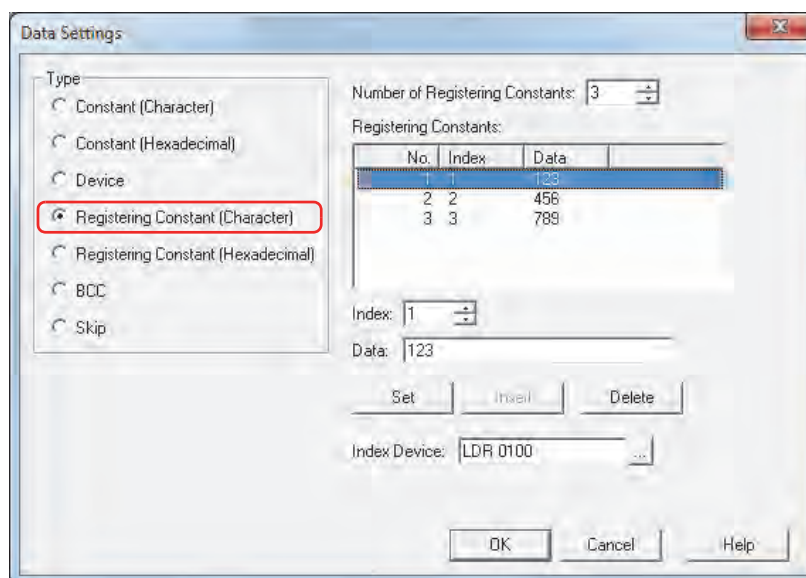

■ Number of Registering Constants

Specify the number of data of the registered character data (1 to 100).

■ Registering Constants

No.: Shows the ID No. (1 to 100) of the character data.

Index: Shows the Index No. of the character data.

Data: Shows the character data.

■ Index

Specify the Index No. (0 to 65535) of the character data.

■ Data

Enter the character data (1 to 1500 bytes) to be registered. The size of a single-byte character is one byte and that of a double-byte character is two bytes.

The character data of different size or the same data with a different number cannot be registered.

■ Set

Register the **Index** and **Data** settings to the list. When a number that is already registered is selected, it is overwritten with the new setting.

■ Insert

Insert a character data setting to the selected number in the list.

Click this button to insert the **Index** and **Data** setting. The settings at the insertion point shift down 1 line. Settings cannot be inserted when all numbers are already set.

■ Delete

Delete the selected settings from the list.

■ Index Device

Specify the word device for storing the Index No. of the character data matching the received data. You can only specify an internal device.

Click to display the Device Address Settings dialog box. For the device address configuration procedure, refer to Chapter 2 "5.1 Device Address Settings" on page 2-61.

Example: Registering Constant (Character) for receive command data

Item	Setting
Number of Registering Constants	3
Registering Constants	Index No. 1: 123
	Index No. 2: 456
	Index No. 3: 789
Index Device	LDR100

When the trigger condition is satisfied, the received data is compared with the registered data, and the value of the Index No. 2 of the matching data is stored in Index Device LDR100.

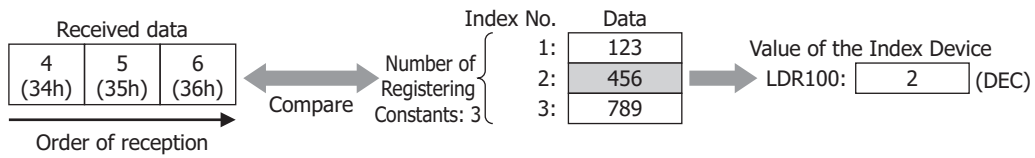

Registering Constant (Hexadecimal)

The received data is compared with the registered hexadecimal data and the number of the matching hexadecimal data is stored in the device.

This can be configured only when **RXD** is selected in **Command Type** on the Command Settings dialog box, and **Registering Constant (Hexadecimal)** is selected under **Type** on the Data Settings dialog box.

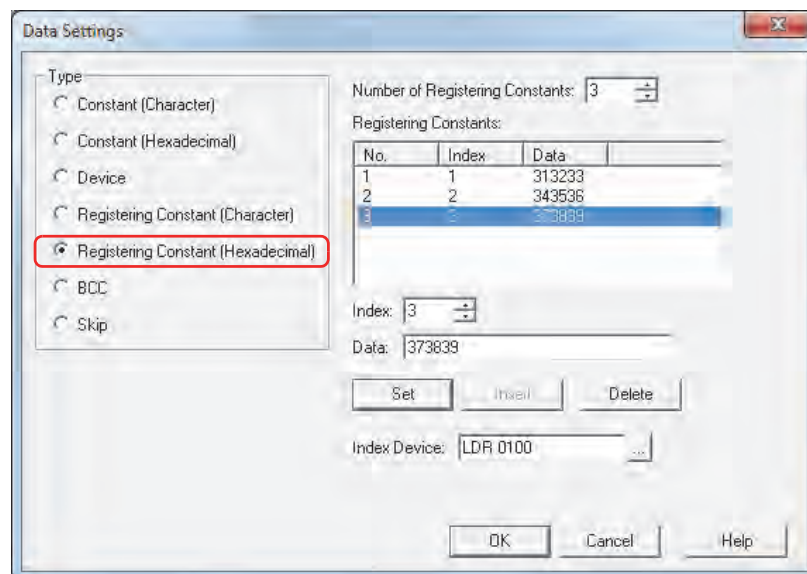

■ Number of Registering Constants

Specify the number of data of the registered hexadecimal data (1 to 100).

■ Registering Constants

No.: Shows the ID No. (1 to 100) of the hexadecimal data.

Index: Shows the Index No. of the hexadecimal data.

Data: Shows the hexadecimal data.

■ Index

Specify the Index No. (0 to 65535) of the hexadecimal data.

■ Data

Enter the hexadecimal data (1 to 1500 bytes) to be registered.

The hexadecimal data of different size or the same data with a different number cannot be registered.

■ Set

Register the **Index** and **Data** settings to the list. When a number that is already registered is selected, it is overwritten with the new setting.

■ Insert

Insert a hexadecimal data setting to the selected number in the list.

Click this button to insert the **Index** and **Data** setting. The settings at the insertion point shift down 1 line. Settings cannot be inserted when all numbers are already set.

■ Delete

Delete the selected settings from the list.

■ Index Device

Specify the word device for storing the Index No. of the hexadecimal data matching the received data. You can only specify an internal device.

Click to display the Device Address Settings dialog box. For the device address configuration procedure, refer to Chapter 2 "5.1 Device Address Settings" on page 2-61.

Example: Registering Constant (Hexadecimal) for receive command data

Item	Setting
Number of Registering Constants	3
Registering Constants	Index No. 1: 1234
	Index No. 2: 5678
	Index No. 3: 2537
Index Device	LDR100

When the trigger condition is satisfied, the received data is compared with the registered hexadecimal data, and the value of the Index No. 2 of the matching data is stored in Index Device LDR100.

When the LDR100 value is 3

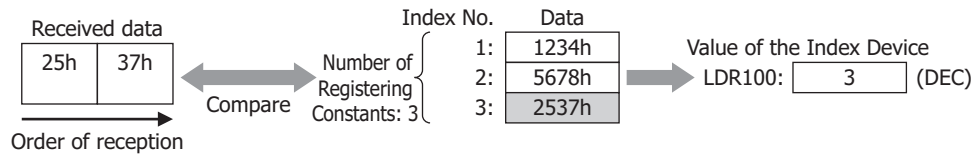

Example of applying Registering Constant

When the same device address is specified for the Index Device for **Registering Constant (Character)** data or **Registering Constant (Hexadecimal)** data and for **Use Reference Device** for **Device** data, the data storage destination for each unit of received data can be changed.

Data type	Item	Setting
Constant (Hexadecimal)	Data	02
Registering Constant (Character)	Number of Registering Constants	2
	Registering Constant	Index No. 1: AA
		Index No. 2: BB
Index Device	LDR100	
Device	Conversion Type	No Conversion
	Device	LDR100
	Use Reference Device	ON, Device: LDR200
	Storage Method for Data	from Upper byte
	Bytes	2
	Words	2
	Variable	OFF
Constant (Hexadecimal)	Data	0D

When the following commands are received

STX (02h)	B (42h)	B (42h)	1 (31h)	2 (32h)	CR (0Dh)
--------------	------------	------------	------------	------------	-------------

- The first 1 byte is taken as the start code. **Constant (Hexadecimal)** data is not stored.

STX (02h)

- The received data is compared with the registered data, and the value of the Index No. 2 (DEC) of the matching data is stored in Index Device LDR100.

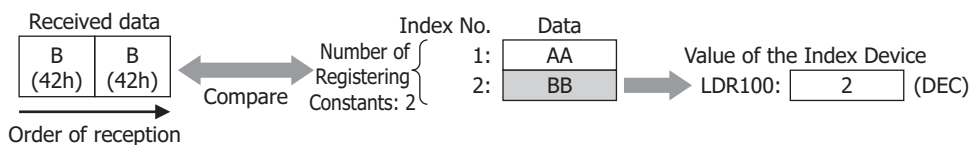

- Since the Indirect Device LDR100 of **Device** of the receive command data is 2 (DEC), the data is stored in the device LDR202, which is offset by +2.

Value of Device

LDR200:	0000h
LDR201:	0000h
LDR202:	3132h

LDR100=2

- The last 1 byte is taken as the terminal code. **Constant (Hexadecimal)** data is not stored.

CR (0Dh)

BCC (Block Check Code)

The BCC comparison data is automatically calculated from the receive data and compared with the BCC part of the receive data.

This can be configured only when **RXD** is selected in **Command Type** on the Command Settings dialog box, and **BCC** is selected under **Type** on the Data Settings dialog box.

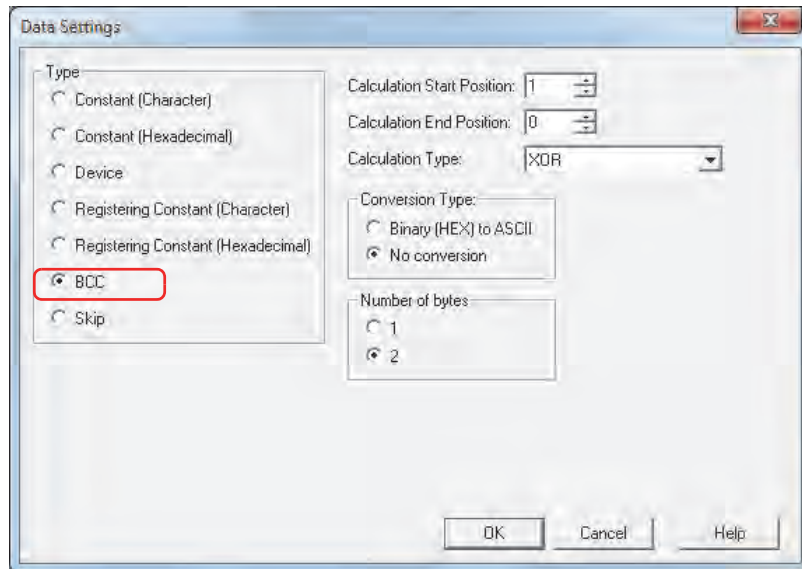

■ Calculation Start Position

Specify the position (1 to 15) in the receive data where BCC calculation starts. The position is counted backwards, with the first position of the receive data taken as 1.

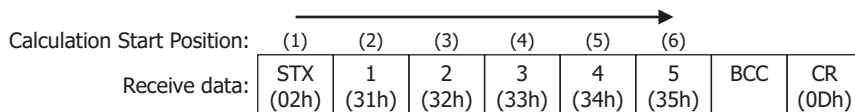

■ Calculation End Position

Specify the position (0 to 15) in the receive data where BCC calculation ends. The position is counted forwards, with the data position before the BCC taken as 0.

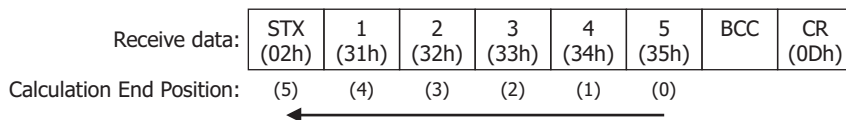

■ Calculation Type

Select the method to calculate the data between the Calculation Start Position and Calculation End Position.

XOR: Calculates the data with exclusive logical add.

ADD: Calculates the data using addition.

ADD (2's Complement): Calculates the data using addition, inverts the bit and adds one.

Modbus ASCII (LCR): Calculation is performed according to the following procedure. Conversion Type: Binary (HEX) to ASCII, Number of bytes: 2

1. Convert the ASCII characters between Calculation Start Position and Calculation End Position into 1-byte hexadecimal data for each set of two characters.

Example: 37h, 35h → 75h

2. Calculate the sum of the data obtained in step 1.

3. Invert the bit of the result of step 2 and add one. (2's complement)

4. Convert the lower one byte data of the result of step 3 into ASCII characters.

Example: 75h → 37h, 35h

- Modbus RTU (CRC): CRC-16 (Generating polynomial: $x^{16}+x^{15}+x^2+1$) is calculated according to the following procedure. Conversion Type: No Conversion, Number of bytes: 2
1. Obtain an exclusive OR (XOR) of 1 byte data at Calculation Start Position and FFFFh.
 2. If the least significant bit of the result of step 1 is 0, shift to the right by one bit. If the bit is 1, shift to the right by 1 bit and obtain XOR of the result and the value (A001h).
 3. Repeat step 2 to shift 8 times.
 4. Obtain XOR of the next one byte of data and the result of step 3.
 5. Repeat steps 2 through 4 until the data at Calculation End Position is processed.
 6. Compare the result of step 5 in the order of the lower byte and upper byte.
- Example: 1234h → 34h, 12h

■ Conversion Type

After calculating the data using the specified calculation type, select the type of conversion for the data from the following.

- Binary (HEX) to ASCII: Considers the data as binary-coded hexadecimal number and converts it to ASCII data.
 No conversion: No conversion is performed.

■ Number of bytes

After converting according to the specified conversion type, select **1** or **2** for the number of bytes for comparison data.

Example: BCC for receive command data

This example describes the case of comparing the BCC calculation result for the following receive data with the BCC part of the receive data.

STX (02h)	1 (31h)	2 (32h)	3 (33h)	4 (34h)	5 (35h)	BCC	CR (0Dh)
--------------	------------	------------	------------	------------	------------	-----	-------------

• Calculation Start Position and Calculation End Position

When Calculation Start Position is 2 and Calculation End Position is 1: Calculates the range **1234**.

Calculation Start Position:	(1)	(2)	(3)	(4)	(5)	(6)		
	STX (02h)	1 (31h)	2 (32h)	3 (33h)	4 (34h)	5 (35h)	BCC	CR (0Dh)
Calculation End Position:	(5)	(4)	(3)	(2)	(1)	(0)		
		Data used for BCC calculation						

• Calculation Type

- XOR: $31h \wedge 32h \wedge 33h \wedge 34h = 04h$
 ADD: $31h + 32h + 33h + 34h = CAh$
 ADD (2's Complement): Inverts the bit of CAh + 1 = 36h
 Modbus ASCII (LCR): **BA** → 42h, 41h
 Modbus RTU (CRC): BA30h → BAh, 30h

• Conversion Type

When the BCC calculation result is **0004h**, the converted data is as follows.

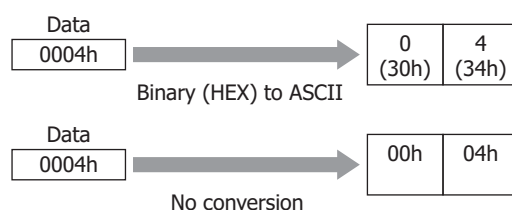

- Number of bytes and comparison data

When the converted data is **3034h**, the data used for comparison with the BCC part of the receive data is as follows.

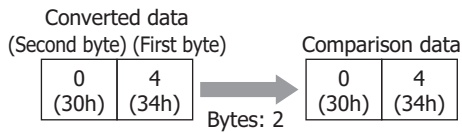
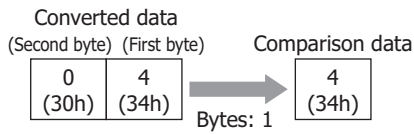

- BCC data comparison

The comparison data is compared with the BCC part of the receive data.

In the following receive data, when the comparison data is the 1-byte 34h, there is a match since the BCC part data is 34h.

When there is no match, the BCC Error (address+0, bit 0) of the Status Device changes to 1.

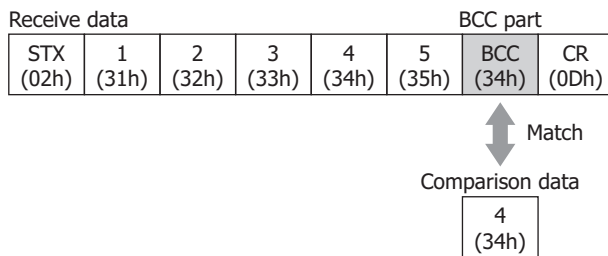

- When the calculation type is **Modbus ASCII (LCR)**

When the BCC calculation result is **4241h** after **Binary (HEX) to ASCII** conversion the resulting two bytes of data is used for comparison with the BCC part of the receive data.

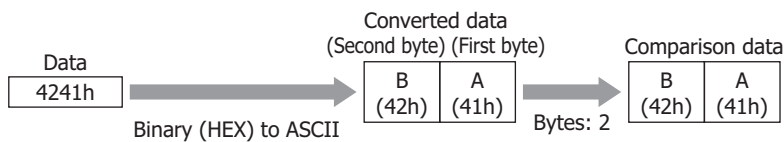

- When the calculation type is **Modbus RTU (CRC)**

When the BCC calculation result is **BA30h** with no conversion the two bytes of data is used for comparison with the BCC part of the receive data.

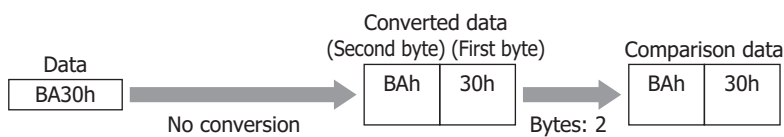

Skip

The data with the specified number of bytes in the receive data will be ignored.

This can be configured only when **RXD** is selected in **Command Type** on the Command Settings dialog box, and **Skip** is selected under **Type** on the Data Settings dialog box.

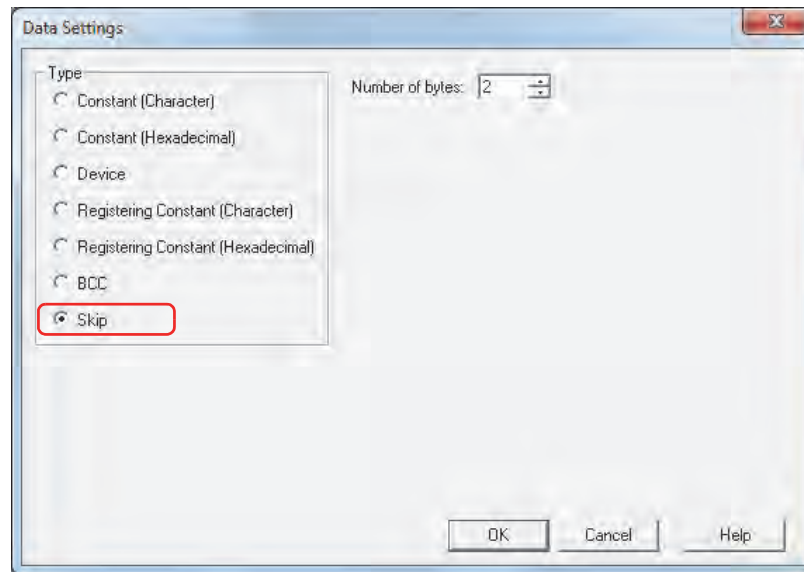

■ Number of bytes

Specify the number of bytes (1 to 249) of receive data to be ignored.

Example: Skip for receive command data

Item	Setting
Number of bytes	2

In the received four byte data (1 (31h), 2 (32h), 3 (33h), 4 (34h)), only the data for 3 (33h) and 4 (34h) is received and the two bytes of 1 (31h) and 2 (32h) are discarded.

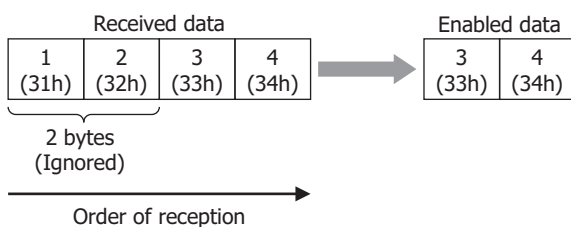

● Start Code and Terminal Code

A start code starts data reception and a terminal code judges the terminal of data reception. A start code and a terminal code can be configured for either **Constant (Character)** or **Constant (Hexadecimal)** settings for receive command. The first 1 byte of the constant is recognized as the start code and the last 1 byte as the terminal code.

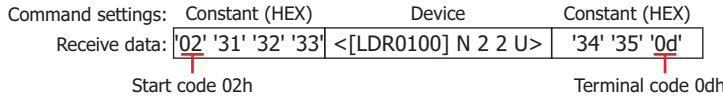

Code 00h to 7Fh can be set when **Data Length** under **Interface Settings** is 7 bits, and 00h to FFh when the data length is 8 bits. **Data Length** is configured under the **Communication Interface** tab on the Project Settings dialog box.

The procedure for terminal of data reception varies whether or not the receive data contains a start code and a terminal code, and whether the **Variable** check box for **Device** for receive command data is selected.

In the following description, **With Variable** indicates that the **Variable** check box for **Device** for receive command data is selected and **Without Variable** indicates that the **Variable** check box is not selected. Also, when there are multiple **Device** set for receive command data, and at least 1 command has the **Variable** check box selected, this corresponds to **With Variable**.

Start code	Terminal code	Variable	Description of the procedure for terminal of data reception
Set	Set	Set Not set	<p>Reception is started with the start code and terminated with the terminal code.</p> <p>Command settings: Constant (HEX) Device Constant (HEX) Receive data: '02' '31' '32' '33' <[LDR0100] N 2 2 U> '34' '35' '0d'</p> <p>Start code 02h Terminal code 0dh</p> <p>Receive</p> <p>When the terminal code is followed by BCC, the data including the number of bytes of BCC is received.</p> <p>Command settings: Constant (HEX) Device Constant (HEX) BCC Receive data: '02' '31' '32' '33' <[LDR0100] N 2 2 U> '34' '35' '0d' BCC(1 0 XOR N 1)</p> <p>Start code 02h Terminal code 0dh</p> <p>Receive</p>
Set	Not set	Set	<p>Reception is started with the start code and the data is received according to the maximum command length.</p> <p>Command settings: Constant (HEX) Device With Variable Registering Constant (HEX) Receive data: '02' '31' '32' <[LDR0100] N 2V 2 U> <<1:"AB" 2:"CD" [LDR0200]>></p> <p>Start code 02h Terminal code: None</p> <p>Maximum command length</p> <p>Receive</p> <p>Reception is terminated when the Receiving Character Time Out occurs.</p> <p>Command settings: Constant (HEX) Device With Variable Constant (HEX) Registering Constant (HEX) Receive data: '02' '31' '32' <[LDR0100] N 2V 2 U> '03' <<1:"AB" 2:"CD" [LDR0200]>></p> <p>Start code 02h Receiving character time out occurs. Terminal code: None</p> <p>Receive</p>
		Not set	<p>Reception is started with the start code and the data is received according to the length of the command.</p> <p>Command settings: Constant (HEX) Device Without Variable Registering Constant (HEX) Receive data: '02' '31' '32' <[LDR0100] N 2 2 U> <<1:"AB" 2:"CD" [LDR0200]>></p> <p>Start code 02h Terminal code: None</p> <p>Command length</p> <p>Receive</p>
Not set	Set	Set Not set	<p>Reception is started from the beginning and terminated with the terminal code.</p> <p>Command settings: Registering Constant (HEX) Device Constant (HEX) Receive data: <<1:"AB" 2:"CD" [LDR0200]>> <[LDR0100] N 2 2 U> '34' '35' '0d'</p> <p>Start code: None Terminal code 0dh</p> <p>Receive</p>

Start code	Terminal code	Variable	Description of the procedure for terminal of data reception						
Not set	Not set	Set	<p>Reception is started from the beginning and the data is received according to the maximum command length.</p> <p>Command settings: Skip Constant (Character) Device With Variable</p> <p>Receive data: <table border="1" style="display: inline-table; vertical-align: middle;"><tr><td>Skip(2)</td><td>"123"</td><td><[LDR0100] N 2V 2 U></td></tr></table></p> <p>Start code: None Terminal code: None</p> <p>Maximum command length</p> <p>Receive</p> <p>Reception is terminated when the Receiving Character Time Out occurs.</p> <p>Command settings: Skip Constant (Character) Device With Variable</p> <p>Receive data: <table border="1" style="display: inline-table; vertical-align: middle;"><tr><td>Skip(2)</td><td>"123"</td><td><[LDR0100] N 2V 2 U></td></tr></table></p> <p>Start code: None Terminal code: None</p> <p>Receiving character time out occurs.</p> <p>Receive</p>	Skip(2)	"123"	<[LDR0100] N 2V 2 U>	Skip(2)	"123"	<[LDR0100] N 2V 2 U>
		Skip(2)	"123"	<[LDR0100] N 2V 2 U>					
Skip(2)	"123"	<[LDR0100] N 2V 2 U>							
Not set	<p>Reception is started from the beginning and terminated when the data is received according to the length of the command.</p> <p>Command settings: Device Without Variable Registering Constant (HEX) BCC</p> <p>Receive data: <table border="1" style="display: inline-table; vertical-align: middle;"><tr><td><[LDR0100] N 2 2 U></td><td><<1:"AB" 2:"CD" [LDR0200]>></td><td>BCC(1 0 XOR N 1)</td></tr></table></p> <p>Start code: None Terminal code: None</p> <p>Command length</p> <p>Receive</p>	<[LDR0100] N 2 2 U>	<<1:"AB" 2:"CD" [LDR0200]>>	BCC(1 0 XOR N 1)					
<[LDR0100] N 2 2 U>	<<1:"AB" 2:"CD" [LDR0200]>>	BCC(1 0 XOR N 1)							



- When trigger conditions are satisfied for two or more receive commands for which both start code and terminal code are set, all commands are analyzed and processed for receive processing. Since commands with and without errors may be mixed depending on the results of data reception analysis of each command, take extra caution regarding error handling.
- While the trigger condition is satisfied for a receive command for which either a start code or terminal code is not set, only this command is processed for data reception when the trigger condition of another command is being satisfied. When two or more commands exist for which either start code or terminal code is not set, the command with the biggest number for managing the protocol is processed.
- When a start code of the receive command for which a start code is set cannot be received, all of the receive data is ignored and abandoned. No error occurs.
- When start code is received with a receive command for which start code and terminal code are set, the data reception is completed after the maximum number of bytes received in case of continuous reception of data that does not match the terminal code of all receive command in which the trigger conditions is satisfied.

5.4 Example of User Communication Settings

This section describes examples of user communication settings and command operations.

● Example 1

This section describes an example of user communication protocol settings for creating the following commands and command operations.

- Transmission command for transmitting data using Constant (Hexadecimal), Constant (Character), Device, Constant (Hexadecimal) command settings when the trigger condition device changes to 1
- Receive command for receiving, processing, and storing data in devices, using Constant (Hexadecimal), Constant (Character), Device, Constant (Hexadecimal) command settings, for data transmitted from an external device, when the trigger condition device is 1

■ User Communication Settings dialog box settings

Item	Setting
Protocol Name	Sample 1
Receiving Character Time Out	30 (×100 msec)

■ Transmission command: Command Settings dialog box settings

Item	Setting	
Comment	TXD command	
Command Type	TXD	
Completed Device	LM101	
Status Device	LDR110	
Transmission Wait	50 (×100 msec)	
Trigger Condition	While ON, Device: LM100	
Command Data Settings dialog box settings	Constant (Hexadecimal)	'05'
	Constant (Character)	"D"
	Device	Conversion Type: Binary (DEC) to ASCII, Number of bytes: 4, Words: 1 Device: LDR100
	Constant (Hexadecimal)	'0D'

Operation for transmission command

- 1 Write a value of 100 (DEC) to LDR100 of transmission command data **Device**.
- 2 Change the trigger condition LM100 from 0 to 1 to start command transmission.

After the transmission wait duration (five seconds), the transmission data is sent. The transmission data is as follows.

Command settings:	Constant (HEX)	Constant (Character)	Device				Constant (HEX)
Transmission data:	EQN (05h)	D (44h)	0 (30h)	1 (31h)	0 (30h)	0 (30h)	CR (0Dh)

- When data transmission is successfully completed, the Completed Device LM101 changes to 1.
- When the value of each bit of address+0 for Status Device LDR110 is 0, transmission is completed without an error.

Receive command: Command Settings dialog box settings

Item	Setting	
Comment	RXD command	
Command Type	Receive	
Completed Device	LM102	
Not Clear Completed Device automatically	No	
Status Device	LDR130	
Receiving Time Out	0 (No Receive Time Out)	
Trigger Condition	While ON, Device: LM101	
Command Data Settings dialog box settings	Constant (Hexadecimal)	'02'
	Constant (Character)	"D"
	Device	Conversion Type: ASCII (HEX) to Binary, Number of bytes: 4, Words: 1 Device: LDR120, Reference Device: LDR100
	Constant (Hexadecimal)	'0D'

Operation for receive command

- 1 When data transmission of the transmission command is completed, the value of LM101 changes to 1, and since the same device is specified for the trigger condition user communication becomes ready for receiving.
- 2 Data is transmitted from the external device and the transmitted data is received and processed.

The receive data is as follows.

Command settings:	Constant (HEX)	Constant (Character)	Device				Constant (HEX)
Receive data:	STX (02h)	D (44h)	1 (31h)	2 (32h)	3 (33h)	4 (34h)	CR (0Dh)

Since a value of 100 is written to LDR100 at the time of transmission, the data is stored in device LDR220, which corresponds to an offset of +100 from LDR120.

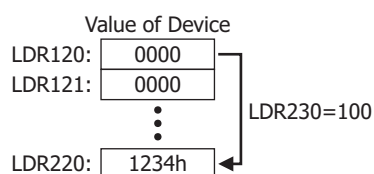

- When data reception is successfully completed, the Completed Device LM102 changes to 1.
- When the value of each bit of address+0 of Status Device LDR130 is 0, reception is completed without an error.

● Example 2

This section describes an example of user communication protocol settings for creating the following commands and command operations.

- Transmission command for transmitting data using Constant (Hexadecimal), Registering Constant (Character), Device, BCC, Constant (Hexadecimal) command settings when the trigger condition device changes to 1
- Receive command for receiving, processing, and storing data in devices, using Constant (Hexadecimal), Registering Constant (Character), Skip, Device, BCC, Constant (Hexadecimal) command settings, for data transmitted from an external device, when the trigger condition device is 1

■ User Communication Settings dialog box settings

Item	Setting
Protocol Name	Sample 2
Receiving Character Time Out	30 (×100 msec)

■ Transmission command: Command Settings dialog box settings

Item	Setting	
Comment	TXD command	
Command Type	Transmit	
Completed Device	LM201	
Status Device	LDR220	
Transmission Wait	0 (×100 msec)	
Trigger Condition	While ON, LM200	
Command Data Settings dialog box settings	Constant (Hexadecimal)	'05'
	Registering Constant (Character)	10: "AB", 20: "CD", Index Device: LDR200
	Device	No Conversion, from Upper byte, Number of bytes: 2, Words: 2 Device: LDR210
	BCC	Start Calculation Position: 1, End Calculation Position: 0, XOR, Binary (HEX) to ASCII, 2 bytes
	Constant (Hexadecimal)	'0D0A'

Operation for transmission command

- 1 Write a value of 10 (DEC) to LDR200 for **Registering Constant (Character)** for transmission command data. **AB** is selected.



- 2 Write a value of 3132h to LDR210 and 3334h to LDR211 for **Device** for transmission command data.
- 3 Change the trigger condition LM200 from 0 to 1 to start command transmission.

The transmission data is as follows.

Command settings:	Constant (HEX)	Registering Constant (Character)	Device				BCC	Constant (HEX)			
Transmission data:	EQN (05h)	A (41h)	B (42h)	1 (31h)	2 (32h)	3 (33h)	4 (34h)	0 (30h)	2 (32h)	CR (0Dh)	LF (0Ah)

- When data transmission is successfully completed, the Completed Device LM201 changes to 1.
- When the value of each bit of address+0 for Status Device LDR220 is 0, transmission is completed without an error.

■ Receive command: Command Settings dialog box settings

Item	Setting	
Comment	RXD command	
Command Type	Receive	
Completed Device	LM203	
Not Clear Completed Device automatically	No	
Status Device	LDR260	
Receiving Time Out	0 (No Receive Time Out)	
Trigger Condition	While ON, Device: LM202	
Command Data Settings dialog box settings	Constant (Hexadecimal)	'02'
	Registering Constant (Character)	10: "AB", 20: "CD", Index Device: LDR230
	Skip	2 bytes
	Device	Conversion Type: No Conversion, from Upper byte, Number of bytes: 2, Words: 2 Device: LDR240, Reference Device: LDR230
	BCC	Calculation Start Position: 1 Calculation End Position: 0, XOR Binary (HEX) to ASCII, 2 bytes
	Constant (Hexadecimal)	'0D'0A'

Operation for receive command

- 1 Change the trigger condition LM202 from 0 to 1 to be ready for receiving user communication.
- 2 Data is transmitted from the external device and the transmitted data is received and processed. The receive data is as follows.

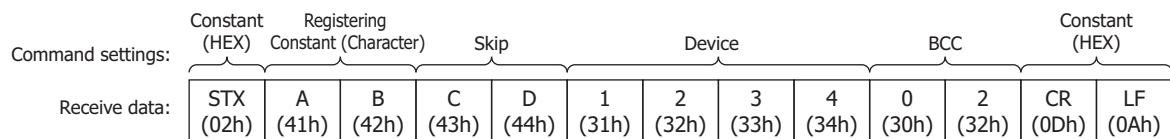

- The receive data is compared with the character data, and the value of the matching Index No. (10 (DEC)) is stored in Index Device LDR230.

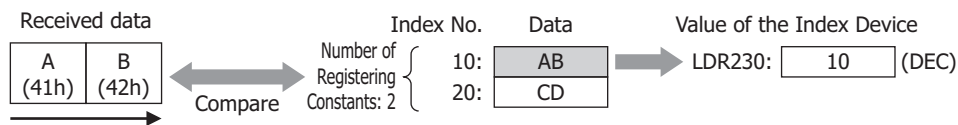

Order of reception

- The 2 bytes (specified with **Skip**) of the receive command data 43h and 44h are ignored.
- Since the Reference Device LDR 230 of **Device** of the receive command data is 10 (DEC), the data is stored in the device LDR250 and LDR251, which is offset by +10.

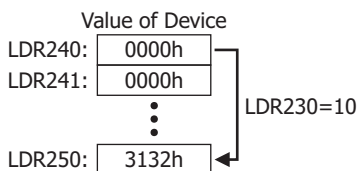

- **[STX] ABCD1234** is calculated with **BCC** of receive command data and compared with 3032h.
- When Calculation Start Position is 1 and Calculation End Position is 0: Calculates the range **STX ABCD1234**.

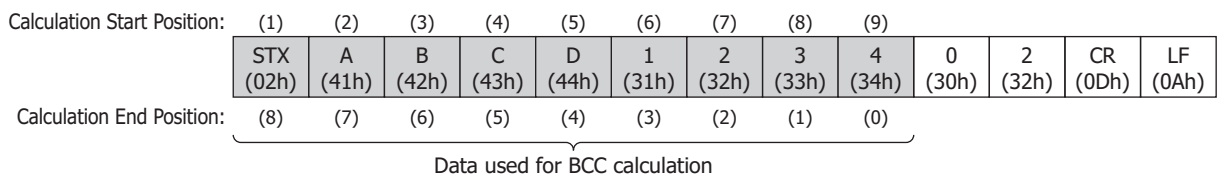

- The BCC calculation type is **XOR**.
 $02h \wedge 41h \wedge 42h \wedge 43h \wedge 44h \wedge 31h \wedge 32h \wedge 33h \wedge 34h = 02h$

- When the BCC calculation result is **0002h**, the converted data will be **3032h**.

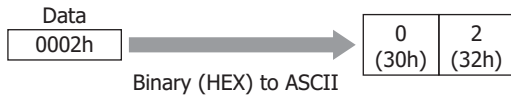

- When the converted data is **3032h**, the data for comparison with the BCC part of the receive data will be **3032h**.

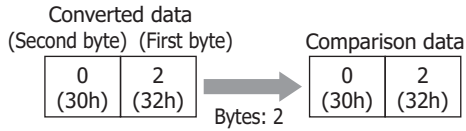

- The comparison data is compared with the BCC part of the receive data.

In the following receive data, when the comparison data is the 2-byte 3032h, there is a match since the BCC part data is 3032h.

When there is no match, the BCC Error (address+0, bit 0) of Status Device changes to 1.

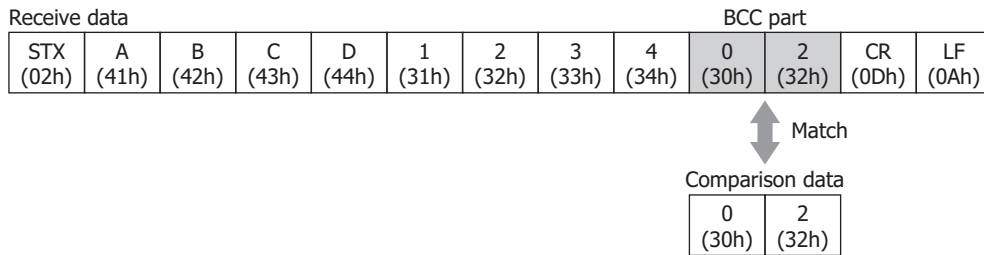

- When data reception is successfully completed, the Completed Device LM203 changes to 1.
- When the value of each bit of address+0 for Status Device LDR250 is 0, transmission is completed without an error.

5.5 Compatible USB Bar Code Readers

The following USB bar code readers can be used with the Touch:

Manufacturer	Type Number
IDEC DATALOGIC	QD2130*1



- Set the USB Barcode Reader to USB-KBD(Keyboard) setting.
- The Touch handles the new line code as 0x0A.

5.6 Connection Diagram for User Communication

When connecting an external device to the Touch via user communication, refer to the following connection diagram.

■ Serial interface (RS232C)

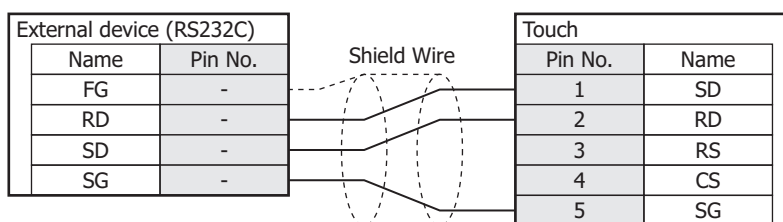

■ Serial interface (RS422/485)

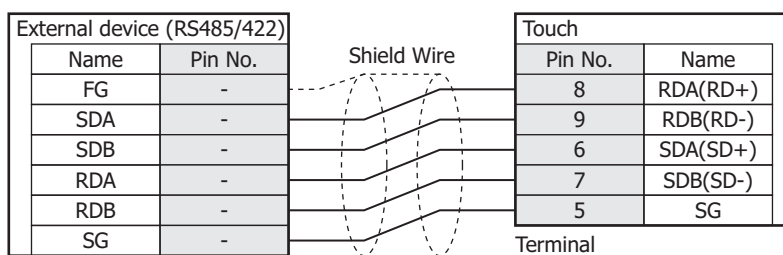

There is no pin No. corresponding to TERM. When a termination resistor is necessary, insert one with suitable resistance value between pin 8 (RDA) and pin 9 (RDB). For details, refer to Chapter 1 "2 Important Points Regarding Wiring" in the "External Device Setup Manual".

*1 in selected country only

Chapter 23 Online Function

This chapter describes in detail on how to setup the online function and the operation of the Touch.

1 Communicating with the Touch

1.1 How the Online Function is Used

The online function enables communication with the Touch in WindO/I-NV3. This communication between WindO/I-NV3 and the Touch, implemented using an exclusive protocol called maintenance communication. The online function enables the following.

- Write a project data into the Touch.

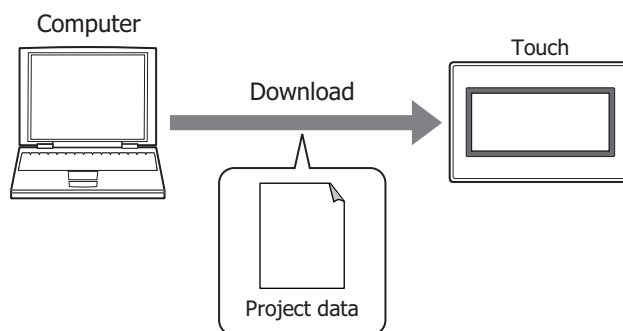

When project data is downloaded using the online function, the Alarm Log data, Data Log data, and Operation Log data in the data storage area are deleted. All internal devices except for the HMI Keep Register (LKR) and HMI Keep Relay (LK) are cleared.



- The following functions can be executed with downloading of project data.
 - Download additional fonts.
 - Download the runtime system.
 - Download recipe files to an External Memory Folder in external memory inserted in the Touch.
 - Clear the HMI Keep Register (LKR) and HMI Keep Relay (LK) after download.
 - Start running the control functions after download.
- For details on writing project data to an external memory inserted in the computer, refer to Chapter 26 "Downloading" on page 26-6.

- Write files to an external memory inserted in the Touch.

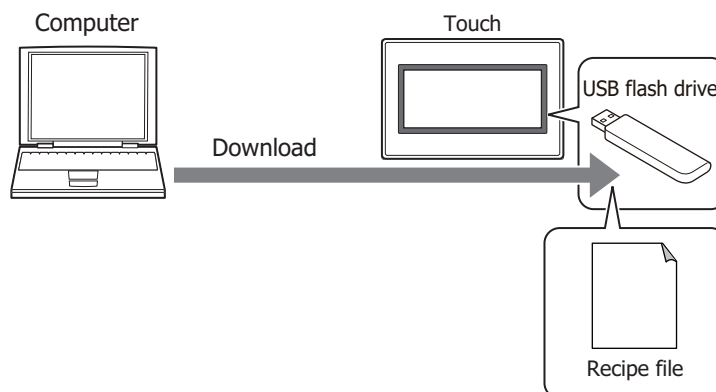

- Read the project data downloaded to the Touch and then save it to a computer.

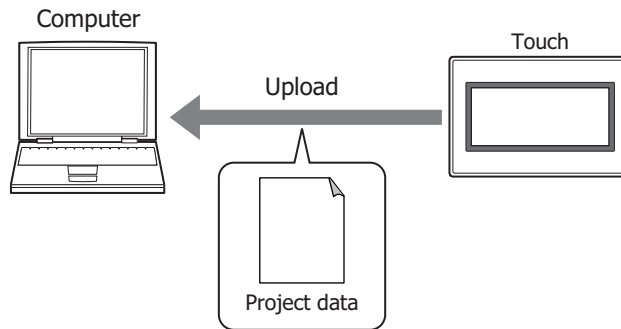

- It is possible to upload recipe files from an External Memory Folder in external memory inserted in the Touch, together with uploading of project data.
- For details on reading project data saved on an external memory using WindO/I-NV3, refer to Chapter 26 “Uploading” on page 26-9.

- Delete the data stored in the internal memory or the external memory inserted in the Touch and format the external memory inserted in the Touch.

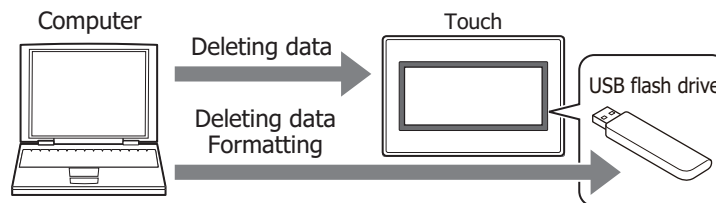

- Display the information about the runtime system and project data of the Touch.

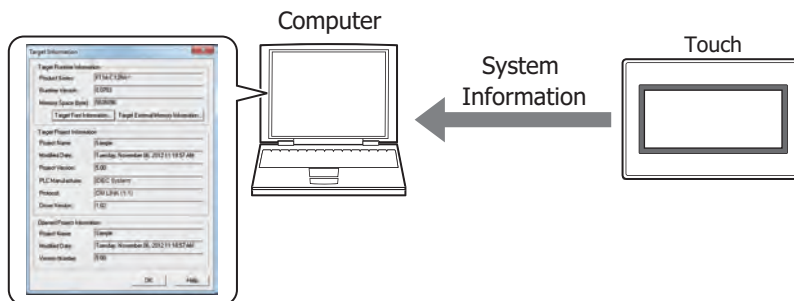

- Edit a project data in WindO/I-NV3 while checking Touch operation by displaying and changing values of devices and switching screens using the monitor function.

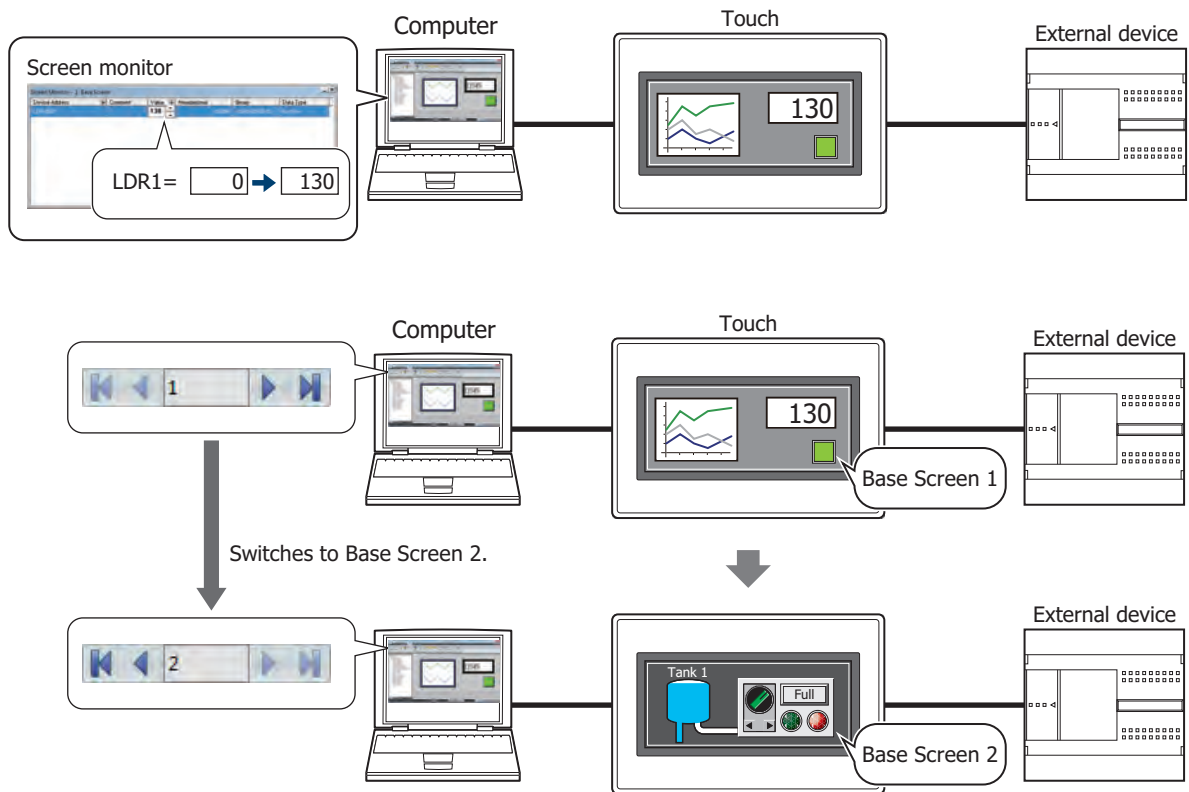

For details about monitor function, refer to Chapter 24 "1 Monitoring with WindO/I-NV3" on page 24-1.

1.2 Connect Touch to a Computer

Connection type varies according to the interface between the Touch and computer.

● USB cable connection

The computer must be running Windows 10/8/7 (64-bit and 32-bit versions), and must have a USB 1.1/2.0 port.

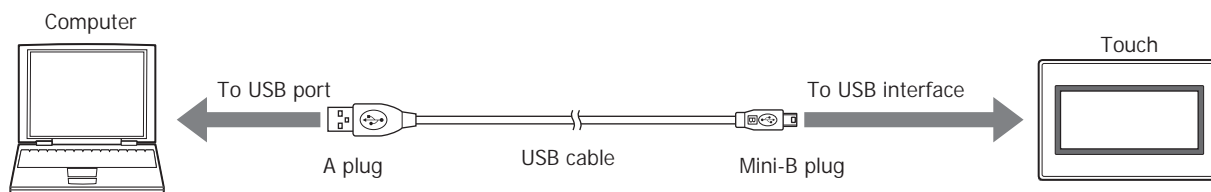

- A USB driver must be installed when connecting the Touch to a computer with a USB cable. Install the USB driver when making the connection for the first time.

For details, refer to “How to install USB driver”. Click ▼ to the right of the  icon at the top right corner of the WindO/I-NV3 window and click **How to install USB driver** to display **How to install USB driver**.

- The USB driver does not have to be installed for subsequent connections.
Note, the connection must use the same USB port that was connected to when installing the USB driver. The computer will not recognize the Touch immediately if the USB cable is connected to a different USB port.



- Multiple Touch connections using different USB ports on the same computer are not supported.
- The computer cannot be connected to the Touch via a USB hub.

● Ethernet cable connection

The computer must be equipped with an Ethernet port.

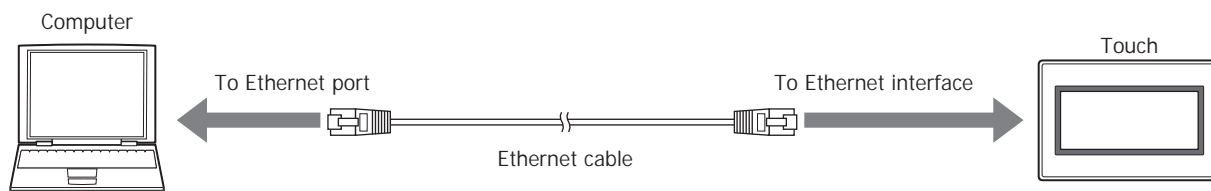

It is necessary to configure the Touch according to the local network that is used.

On the **Communication Interface** tab in the Project Settings dialog box, specify the IP address, subnet mask, and default gateway, and clear the **Forbid Maintenance Communication** check box. For details, refer to Chapter 3 “3.2 Communication Interface Tab” on page 3-27.

1.3 Change Communication Settings

To communicate with the Touch in WindO/I-NV3, configure the settings such as communication speed and port used to match the connection method for the Touch.

- 1 On the **Home** tab, in the **Project** group, click **Comm.Setup**.

The Communication Settings dialog box is displayed.

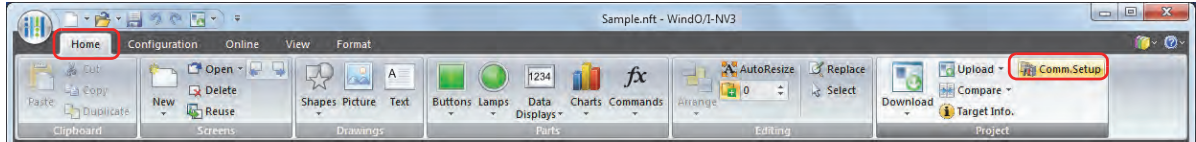

- 2 Change the settings on each tab as necessary and then click **OK**.

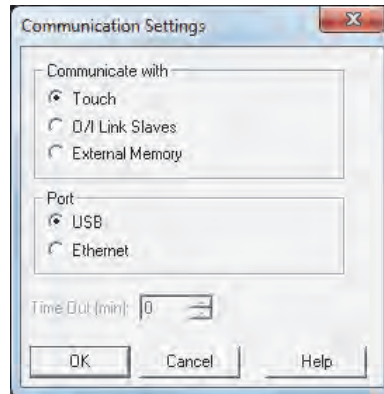

■ Communicate with

Select the device to communicate with from the following items.

Touch:

Communicate with the Touch connected to the computer.

For details, refer to "Using the online function for Ethernet communication" on page 23-7.

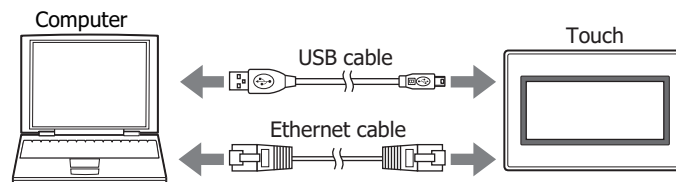

O/I Link Slaves:

Communicate with an O/I Link Slave Touch via an O/I Link Master.

For details, refer to "Using the online function with an O/I Link Slave via an O/I Link Master" on page 23-8.

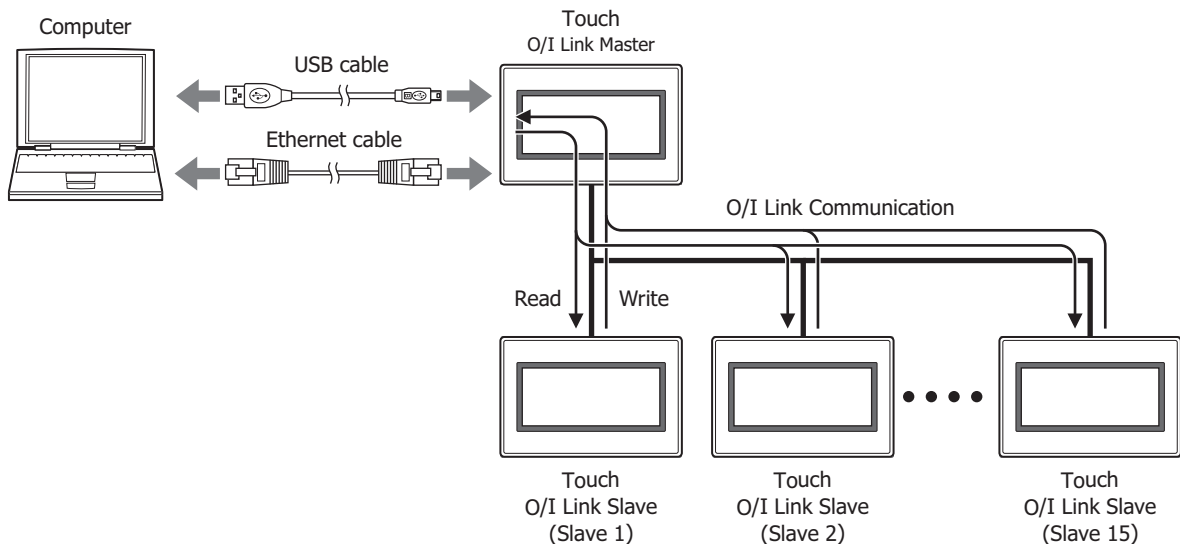

External Memory: Read or write data to the external memory inserted in the Touch connected to the computer.
For details, refer to Chapter 26 "1.4 Reading/Writing Data" on page 26-3.

■ **Port**

Select the communication port on the computer from the following items.

USB: Connect the USB port on the computer to the USB interface on the Touch.

Ethernet: Connect the Ethernet port on the computer to the Ethernet interface on the Touch.



The initial values of the network settings on the Touch are as follows.

IP Address: 192.168.0.1

Subnet Mask: 255.255.255.0

■ **Time Out (min)**

Specify the time to wait for a response from the Touch (1 minute to 20 minutes).

This option can only be configured when **Ethernet** is selected for **Port**.

- Using the online function for Ethernet communication
Select **Ethernet** under **Port** on the Target IP Address dialog box.



It is necessary to set the IP address, subnet mask, and default gateway of the Touch according to the local network that is used.

For details about Ethernet communication, refer to Chapter 3 “3.2 Communication Interface Tab” on page 3-27.



The initial values of the network settings on the Touch are as follows.

IP Address: 192.168.0.1
Subnet Mask: 255.255.255.0

To download project data

Click **Download** in the Download dialog box to display the Target IP Address dialog box.

Specify the Ethernet settings (IP address, subnet mask, and default gateway) for the Touch.

Select the Touch IP addresses and you can batch download project data to multiple Touch.

It is also possible to change the Ethernet settings (IP address, subnet mask, and default gateway) of the Touch to which you are downloading after project data is downloaded.

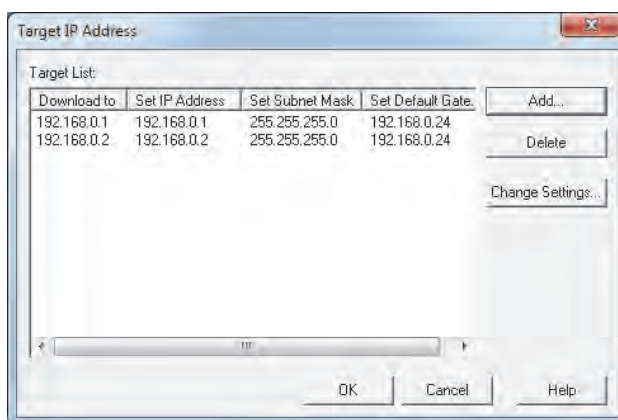

■ Target List

- Download to: Shows the current IP address for the Touch to download the project data to.
- Set IP Address: Shows the IP address for the Touch after downloading the project data.
- Set Subnet Mask: Shows the subnet mask for the Touch after downloading the project data.
- Set Default Gateway: Shows the default gateway for the Touch after downloading the project data.

■ Add

Adds a download destination for project data to the list. Click this button to open IP Address Manager. Using **IP Address Manager**, specify the Ethernet settings for the Touch to which you are downloading.

■ Delete

Deletes download destinations from the list.

■ Change Settings

Changes the Ethernet settings of the Touch to which you are downloading after project data is downloaded.

Select a download destination from the list, and then click **Change Settings** to display **IP Address Manager**. Using **IP Address Manager**, specify the Ethernet settings of the Touch after downloading.



Even if the Ethernet settings of the Touch are changed by using the Target IP Address dialog box when downloading a project, the Ethernet settings in the editing project data are not changed.

To execute any function except project data download

The Target IP Address dialog box will be displayed when any of the following functions are executed.

- Upload a project data.
- Upload data from an external memory inserted in the Touch.
- Delete data stored in the internal memory.
- Delete data from or formatting an external memory inserted in the Touch.
- Display information about runtime system and project data.
- Monitor the Touch.

Specifies the IP address of the Touch used for communication.

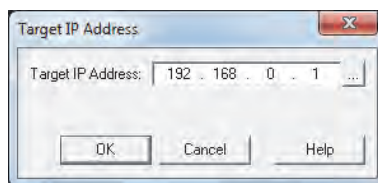

■ Target IP Address

Specify the IP address for the target Touch to execute this function.

Click  to display IP Address Manager. Specify the IP address for the target Touch with IP Address Manager.

● Using the online function with an O/I Link Slave via an O/I Link Master

Select **O/I Link Slaves** under **Communicate with** on the Communication Settings dialog box.



When a Touch used as an O/I Link Master or O/I Link Slave is connected with a computer, select **Touch** in the Communication Settings dialog box.

For details about O/I Link Communication, refer to Chapter 22 “2 O/I Link Communication” on page 22-3.



- The MICRO/I models that can communicate with the Touch using O/I Link Communication are the HG2G-S/-5S/-5F, and HG3G/4G.
- During communication with an O/I Link Slave using the online function, O/I Link Master operation is stopped.

To download project data

Click **Download** in the Download dialog box to display the Target Slaves dialog box.

Specify the slave station number of the Touch to which you are downloading. You can download project data to multiple Touches.

Also, it is possible to change the slave station number the Touch to which you are downloading after project data is downloaded.

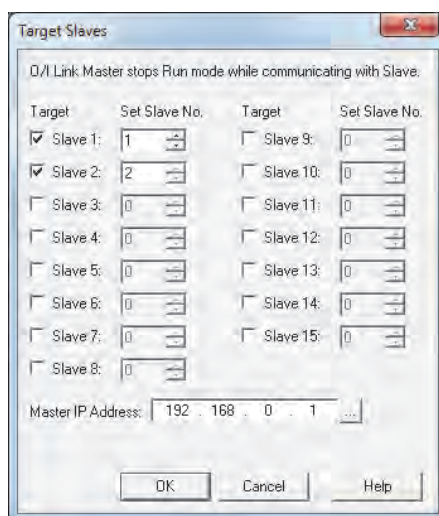

■ Target

Select slave stations (Slave 1 through Slave 15 of the download target).

■ Set Slave No.

The slave station number of the Touch to which you are downloading is changed after project data is downloaded. Specifies the new slave station number (1 to 15) applied to the Touch after downloading a project data.



If the slave station number of the Touch is duplicated after downloading, communication is not possible.



Even if the slave station number of the Touch configured in the Target IP Address dialog box when downloading a project is rewritten, project data remains unchanged during editing.

■ Master IP Address

Specifies the IP address of the O/I Link Master that is used to communicate between the O/I Link Slave and the external device.

Click to display IP Address Manager. Specify the IP address for the O/I Link Master with IP Address Manager.

This option can only be displayed when **O/I Link Slave** is selected for **Communicate with** and **Ethernet** is selected for **Port** in the Communication Settings dialog box.

To execute any function except project data download

The Target Slave dialog box will be displayed when any of the following functions are executed.

- Upload project data.
- Upload data from an external memory inserted in the Touch.
- Delete data stored in the internal memory of the Touch.
- Delete data from or format an external memory inserted in the Touch.
- Display information about runtime system and project data.
- Monitor the Touch.

Specifies the O/I Link Slave.

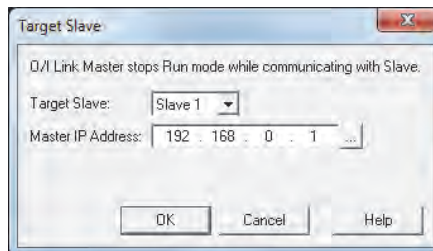

■ Target Slave

Select the slave station number (Slave 1 to Slave 15) that will be the subject of the operation.

■ Master IP Address

Specify the IP address of the O/I Link Master that is used to communicate between the O/I Link Slave and the external device.

Click to display IP Address Manager. Specify the IP address for the O/I Link Master with IP Address Manager.

This option can only be displayed when **O/I Link Slave** is selected for **Communicate with** and **Ethernet** is selected for **Port** in the Communication Settings dialog box.

● IP Address Manager

You can register target Ethernet settings for performing online function via Ethernet communication to the project data.

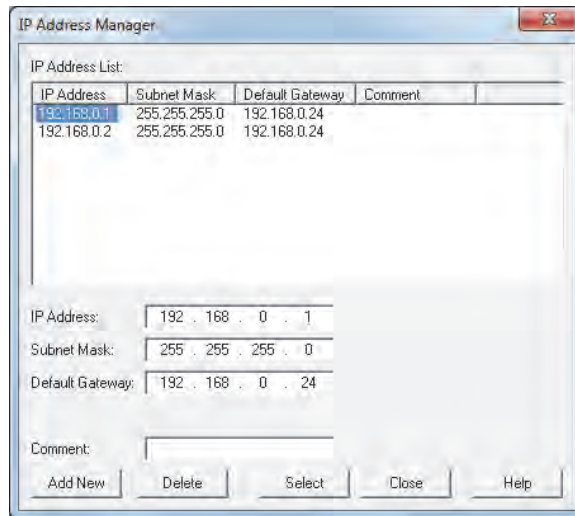

■ IP Address List

Ethernet settings registered in the project data are displayed in this list.

- IP Address: Shows the IP address.
- Subnet Mask: Shows the subnet mask.
- Default Gateway: Shows the default gateway.
- Comment: Shows comment.

■ IP Address

Enter the IP address to register in the project data.

■ Subnet Mask

Enter the subnet mask to register in the project data.

■ Default Gateway

Enter the default gateway to register in the project data.

■ Comment

Enter comment to register in the project data.

■ Add New

Adds **IP Address**, **Subnet Mask**, **Default Gateway**, and **Comment** to the list.

■ Delete

Deletes the selected IP address from the list.

■ Select

Closes IP Address Manager, and apply the Ethernet settings selected from the list.

2 Downloading

2.1 Downloading Project Data to the Touch

- 1 Change communication settings according to the connection method between the computer and the Touch.

In the Communication Settings dialog box, select **Touch** from **Communicate with**. To communicate with the Touch as an O/I Link Slave via an O/I Link Master, select **O/I Link Slave**. For details, refer to "1.3 Change Communication Settings" on page 23-5.

- 2 Open a project to download.



To download a project without opening it, on the **Home** tab, in the **Project** group, click the **Download** icon. The Open dialog box is displayed. Select a file then click **Open**. The Download dialog box is displayed. Proceed to Step 4.



When project data is downloaded to the Touch, the Touch screen data is overwritten.

- 3 On the **Home** tab, in the **Project** group, click the **Download** icon.

The Download dialog box is displayed.

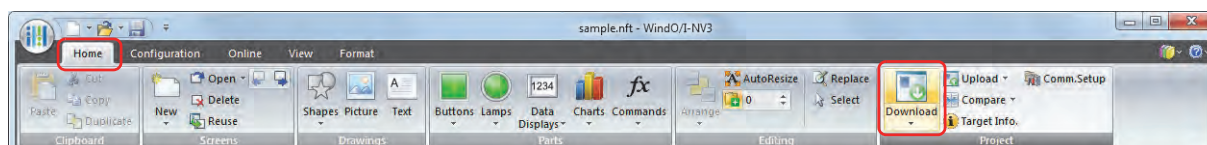

If the project data was changed, a confirmation message to save the project data is displayed.

- Click **OK** to save the project data and display the Download dialog box.
- Click **Cancel** to return to the editing screen without saving the project data.

- 4 Select data for download under **Download Data**.

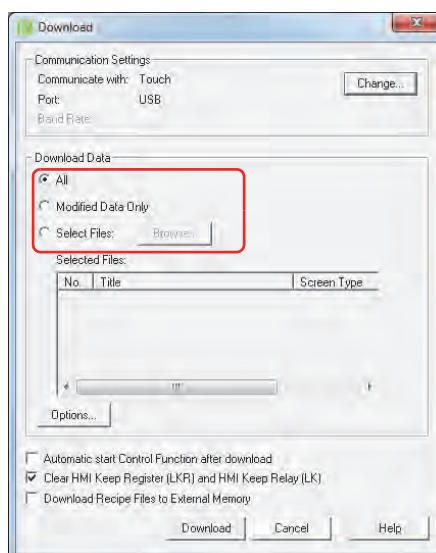

- **All**
Download the entire project data.
- **Modified Data Only**
Downloads files modified since the previous download.
If download fails, select **All** to download.
- **Select Files**
Download the specified files. Click **Browse** to display the Open Screens dialog box. Select **Screen Type**, select the screen to be downloaded from **Screen List** and then click **OK**. The selected screen is added to the list.

5 Click **Download**.

- When **Communicate with** is set to **Touch** and **Port** to **USB**, the project data starts downloading.
- When **Communicate with** is set to **Touch** and **Port** to **Ethernet**, the Target IP Address dialog box is displayed. Specify the IP address of the Touch, and then click **OK** to start the download. For details, refer to “To download project data” on page 23-7.
- When **Communicate with** is set to **O/I Link Slave**, the Target Slave dialog box is displayed. Specify the slave station of the Touch to download to, then click **OK** to start the download.
If **Port** is set to **Ethernet**, specify the IP address of the O/I Link Master via which to download. For details, refer to “To download project data” on page 23-8.



If security is enabled in the Touch project, the Password Screen is displayed. Enter the password.
For details, refer to Chapter 21 “User Accounts and the Security Function” on page 21-1.

6 Click **Yes**.

The Download Project dialog box is displayed and the project file starts downloading.
When finished downloading, a completion message is displayed.

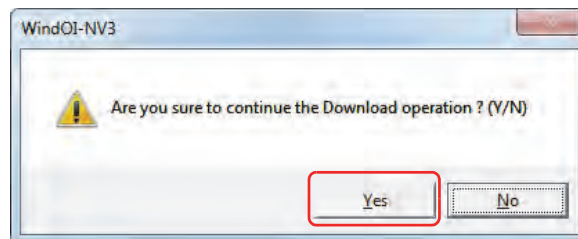

7 Click **OK**.

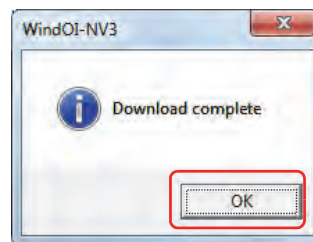

8 Click **Close** on the Download Project dialog box.

This concludes downloading project data.

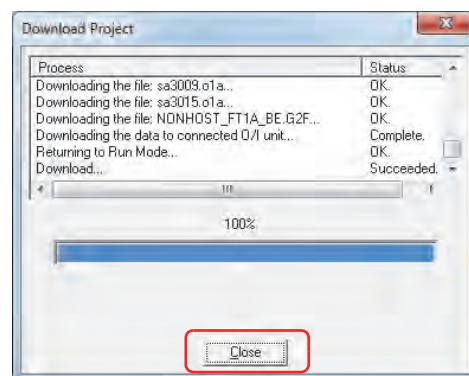

- Do not turn off the Touch while project data is downloading.
- If project data downloading fails and communication is not possible, turn the Touch off and on, then download the data once again.
- During communication with an O/I Link Slave using the online function, O/I Link Master operation is stopped.



For details on writing project data to an external memory inserted in the computer, refer to Chapter 26 “Downloading” on page 26-6.

2.2 Download Dialog Box

This section describes items and buttons of the Download dialog box.

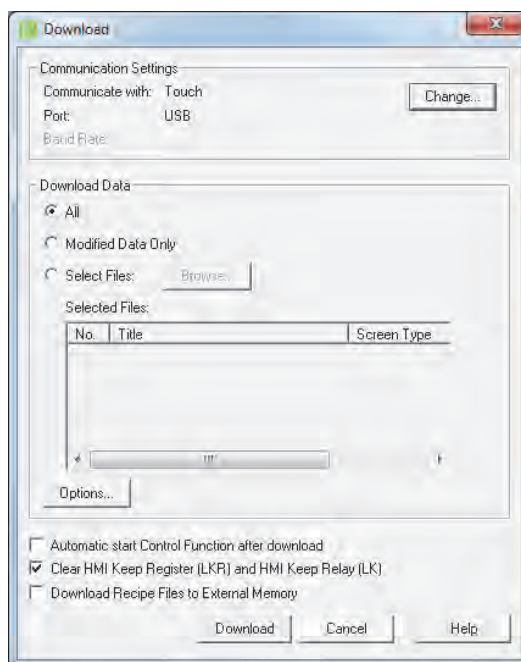

■ Communication Settings

Communicate with: Available computer devices are displayed.

Port: Available communication ports on the computer are displayed.

Change: Changes communication settings. Click this button to display the Communication Settings dialog box. For details, refer to “1.3 Change Communication Settings” on page 23-5.

■ Download Data

Selects data to be downloaded.

All: All project data is downloaded.

Modified Data Only: Only files that were updated since the previous download are downloaded.
If an upload fails, select **All** to download.

Select Files: Specifies a screen for download.

Browse: The screen to be downloaded is added to the list. Click **Browse** to display the Open Screens dialog box. Select **Screen Type**, then select the screen to be downloaded from **Screen List**, and then click **OK**. The selected screen is then added to the list.

Specific Data List: Lists the properties of the specified screen

No.: Displays the Screen No. of the specified screen

Title: Displays the title of the specified screen

Screen Type: Displays the screen type of the specified screen

File Name: Displays the file name of the specified screen

Options: Used for settings to download runtime system and additional fonts. Click to display the Options dialog box. For details, refer to “Options dialog box” on page 23-15.

■ Automatic start Control Function after download

After project data is downloaded, the ladder program or FBD program starts automatically (M8000 is set to 1).

■ Clear Keep Device

Select this check box to clear Keep Device after the project data is downloaded. Note that when a project data with a changed data storage area setting is downloaded, Keep Device are always cleared.

■ Download Recipe Files to External Memory

Select this check box to create a **RECIPE** folder or recipe files in an External Memory Folder on an external memory inserted in the Touch when downloading projects. Only on channels for which **Save to** in the Recipe Settings dialog box is set to **External Memory**, and **Recipe Function** is set to **Use**.

- When **Download Data** is set to **All**, recipe files are created for all channels for which recipe data is set.
- When **Download Data** is set to **Modified Data Only**, only recipe files on channels where recipe data has changed are created.
- When **Download Data** is set to **Select Files**, no recipe file is created.

■ Download

- When **Communicate with** is set to **Touch** and **Port** to **USB**, the project data starts downloading.
- When **Communicate with** is set to **Touch** and **Port** is set to **Ethernet**, the Target IP Address dialog box is displayed. Specify the IP address of the Touch, and then click **OK** to start the download. For details, refer to “To download project data” on page 23-7.
- When **Communicate with** is set to **O/I Link Slave**, the Target Slave dialog box is displayed. Specify the slave station of the Touch to download to, then click **OK** to start the download.
If **Port** is set to **Ethernet**, specify the IP address of the master via which to download. For details, refer to “To download project data” on page 23-8.
- When **Communicate with** is set to **External Memory**, the Select Drive dialog box is displayed. Select the external memory drive, then click **OK** to start the download. For details, refer to “2.3 Downloading Files to an External Memory Inserted in the Touch” on page 23-16.



- Do not turn off the Touch while project data is downloading.
- If project data downloading fails and communication is not possible, turn the Touch off and on then download the data once again.
- During communication with an O/I Link Slave using the online function, O/I Link Master operation is stopped.

■ Cancel

Stops downloading of project data.

Options dialog box

Download runtime system and additional fonts.

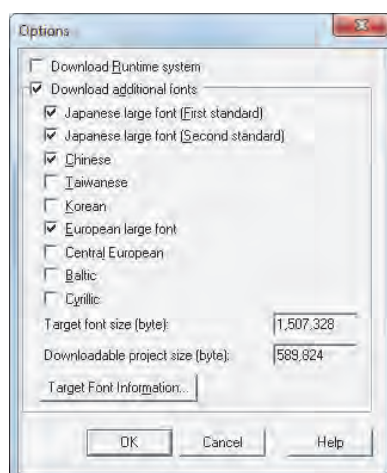

■ Download Runtime system

Select this check box to force download runtime system, irrespective of the runtime system version of the Touch, when downloading project data. Normally this option should not be used.

■ Download additional fonts

Select this check box to download additional fonts when downloading project data.

If this check box is selected, the following additional fonts can be selected for download to the Touch.

Japanese Large Font (First standard), Japanese Large Font (Second Standard), Chinese, Taiwanese, Korean, European Large Font, Central European, Baltic, and Cyrillic.



- For details about additional fonts, refer to Chapter 2 “Installed Fonts in the Touch” on page 2-6.
- Clear the **Download Additional Fonts** check box, to delete all additional fonts that have been downloaded to the Touch.
- The additional fonts downloaded to the Touch whose check box is cleared will be deleted from the Touch.

Target font size (byte):	Shows the total size of the basic fonts and selected additional fonts. If no additional fonts are selected for download to the Touch, shows the size of the basic fonts.
Downloadable project size (byte):	Shows the amount of project data that can be downloaded. This figure varies according to the additional fonts selected.
Target Font Information:	Confirms the additional fonts installed on the Touch.

2.3 Downloading Files to an External Memory Inserted in the Touch

Specified files can be downloaded to an external memory inserted in the Touch. The files are downloaded to External Memory Folder specified in the Project Settings dialog box for the current project.

- 1 Insert the external memory into the Touch.

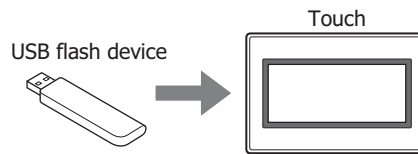

- 2 Change communication settings according to the connection method between the computer and the Touch.

In the Communication Settings dialog box, select **Touch** from **Communicate with**. To communicate with the Touch as an O/I Link Slave via an O/I Link Master, select **O/I Link Slave**. For details, refer to "1.3 Change Communication Settings" on page 23-5.

- 3 On the **Home** tab, in the **Project** group, click the arrow under **Download**.



While editing project data, even if you click the arrow under **Download** in the **Transfer** group on the **Online** tab, the download menu will be displayed.

- 4 Select the method for downloading the file to the external memory.

The Open dialog box is displayed.

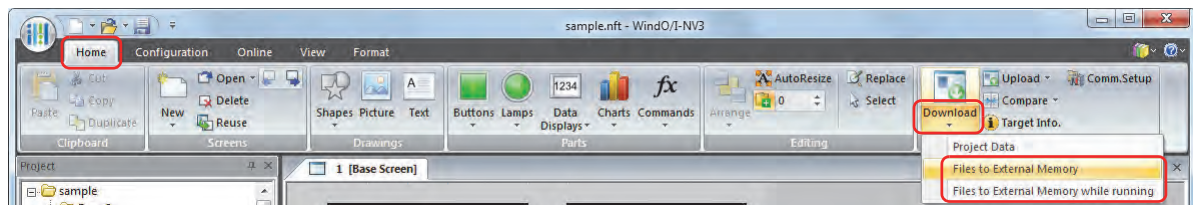

Files to External Memory

Stops operation of the Touch and downloads the file to the external memory inserted in the Touch. When the file download is complete, operation resumes.

Files to External Memory while running

Downloads the file to the external memory inserted in the Touch without stopping operation of the Touch.

- 5 Select the file, and then click **Open**.

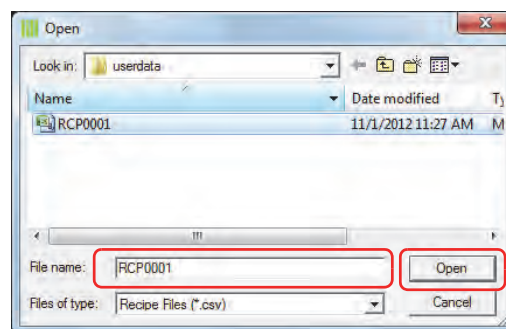

- When **Communicate with** is set to **Touch** and **Port** to **USB**, the project data starts downloading.
- When **Communicate with** is set to **Touch** and **Port** to **Ethernet**, the Target IP Address dialog box is displayed. Specify the IP address of the Touch, and then click **OK** to start the download. For details, refer to "To execute any function except project data download" on page 23-8.
- When **Communicate with** is set to **O/I Link Slave**, the Target Slave dialog box is displayed. Specify the slave station of the Touch to download to, then click **OK** to start the download. If **Port** is set to **Ethernet**, specify the IP address of the master via which to download. For details, refer to "To execute any function except project data download" on page 23-9.



If security is enabled in the Touch project, the Password Screen is displayed. Select the user name and enter the password.

For details, refer to Chapter 21 "User Accounts and the Security Function" on page 21-1.

6 Click **Yes**.

The External Memory Maintenance dialog box is displayed and the file starts downloading. When finished downloading, a completion message is displayed.

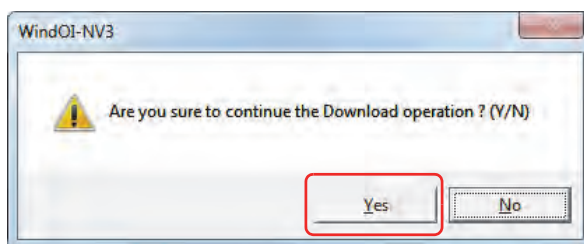
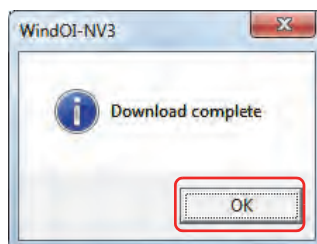
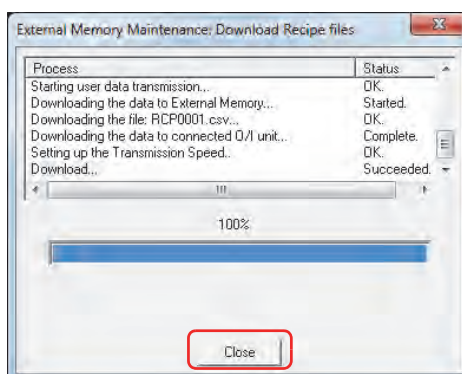
7 Click **OK**.8 Click **Close** in the External Memory Maintenance dialog box.

During communication with an O/I Link Slave using the online function, O/I Link Master operation is stopped.



To create a recipe file on an external memory inserted in the computer, use **Save Recipe File to External Memory** in the Recipe Settings dialog box. For details, refer to Chapter 18 "Creating Recipe Files in the Recipe Settings Dialog Box" on page 18-17.

3 Uploading

Project data in the Touch or in an external memory inserted in a computer can be read using WindO/I-NV3 and saved to the computer.

3.1 Upload Project Data from the Touch

- 1 Change communication settings according to the connection method between the computer and the Touch.

In the Communication Settings dialog box, select **Touch** from **Communicate with**. To communicate with the Touch as an O/I Link Slave via an O/I Link Master, select **O/I Link Slave**. For details, refer to “1.3 Change Communication Settings” on page 23-5.

- 2 On the **Home** tab, in the **Project** group, click the **Upload** icon.



While editing project data, project data can be uploaded from the Touch even by clicking the **Upload** icon in the **Transfer** group on the **Online** tab.

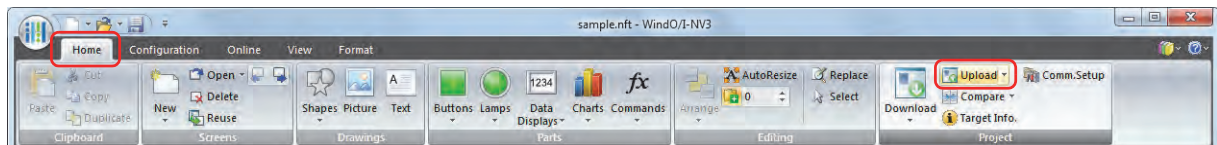

If project data is being edited, project data will be closed. If the project data was changed, a confirmation message to save the project data is displayed.

- Click **Yes** to save the project data and display a dialog box corresponding to the communication settings.
- Click **No** to close the project data without saving changes and display a dialog box corresponding to the communication settings.
- Click **Cancel** to stop uploading and return to the editing screen without saving the project data.

- When **Communicate with** is set to **Touch** and **Port** is set to **USB**, the Upload dialog box is displayed.
- When **Communicate with** is set to **Touch** and **Port** is set to **Ethernet**, the Target IP Address dialog box is displayed. Specify the IP address of the Touch, and then click **OK** to start the upload. For details, refer to “To execute any function except project data download” on page 23-8.
- When **Communicate with** is set to **O/I Link Slave**, the Target Slave dialog box is displayed. Specify the slave station of the Touch to communicate with, and then click **OK** to display the Upload dialog box. If **Port** is set to **Ethernet**, specify the IP address of the master via which to upload. For details, refer to “To execute any function except project data download” on page 23-9.



If security is enabled in the Touch project, the Password Screen is displayed. Enter the password. For details, refer to Chapter 21 “User Accounts and the Security Function” on page 21-1.

3 Check the project data details, and then click **Upload**.

If there is a project file with the same file name in the upload folder, an overwrite confirmation message is displayed.

- Click **Yes** to start uploading the project data.
- Click **Cancel** to stop uploading the project data.

When finished uploading, a completion message is displayed.

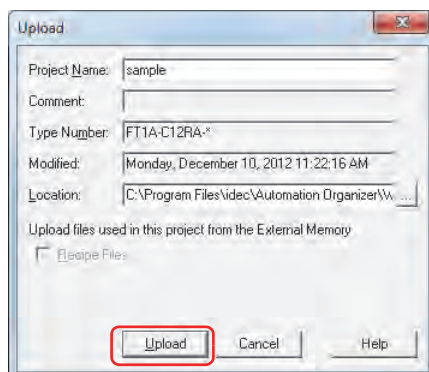

■ Project Name

The project file is saved with the currently displayed name. To change the project name, enter a new name for the file. The maximum number is 50 characters.



You cannot use the following characters in the project name.

\\ / : * ? " < > |

■ Location

The uploaded project file is saved to the currently displayed location. To change the location of the saved file, click . The Save Project After Uploading dialog box is displayed. Select a location, and then click **Save**.

4 Click **OK**.



5 Click **Close** on the Upload dialog box.

A confirmation message to open the project is displayed.

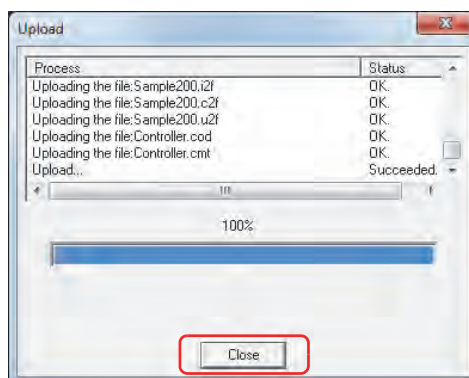

6 Click **OK**.

The uploaded project opens.

This concludes uploading of project data.

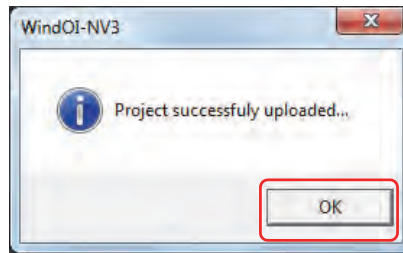

During communication with an O/I Link Slave using the online function, O/I Link Master operation is stopped.



For details on reading project data saved on an external memory using WindO/I-NV3, refer to Chapter 26 "Uploading" on page 26-9.

3.2 Upload Dialog Box

This section describes the settings and buttons of the Upload dialog box.

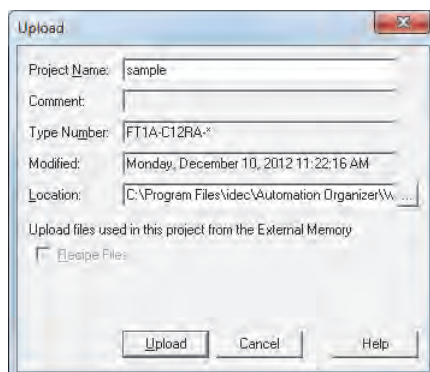

■ Project Name

The project file is saved with the currently displayed name. To change the project name, enter a new name for the file. The maximum number is 50 characters.



You cannot use the following characters in the project name.

\\ : * ? " < > |

■ Comment

Displays comment on project data downloaded to the Touch.

■ Type Number

Displays the type number selected in project data downloaded to the Touch.

■ Modified

Displays the time that project data downloaded to the Touch was last saved in WindO/I-NV3.

■ Location

Specifies the location for saving uploaded project files.

Click to display the Save Project After Uploading dialog box. Select the location for saving, then click **Save**.

■ Upload files used in this project from the External Memory

To upload files located on an external memory inserted in the Touch that are used by the project together with project data, select the file to be uploaded from the following.

Recipe Files

■ Upload

Starts uploading of project data.

■ Cancel

Stops uploading of project data.

4 Clear

Deletes data from the Touch or from an external memory inserted in the Touch.

4.1 Clear Data from the Touch

- 1 Change communication settings according to the connection method between the computer and the Touch.

In the Communication Settings dialog box, select **Touch** from **Communicate with**. To communicate with the Touch as an O/I Link Slave via an O/I Link Master, select **O/I Link Slave**. For details, refer to "1.3 Change Communication Settings" on page 23-5.

- 2 Open project data.

- 3 On the **Online** tab, in the **Touch** group, click **Clear**, then click the data to be deleted.

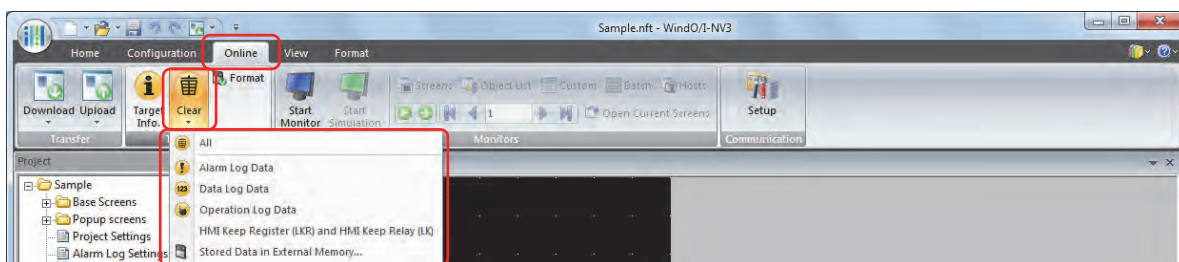

■ All

Deletes project data, Alarm Log data, Data Log data, and Operation Log data. It also clears the HMI Keep Register (LKR) and HMI Keep Relay (LK).

■ Alarm Log Data

Deletes the data collected by the Alarm Log function.

■ Data Log Data

Deletes the data collected by the Data Log function.

■ Operation Log Data

Deletes the data collected by the Operation Log function.

■ Data of all Device Addresses

Clears the data of all device addresses.

■ Stored Data in External Memory

After stopping operation, deletes data saved to an External Memory Folder on an external memory.

Click this to display the Clear Data dialog box. For details, refer to "4.2 Deleting Data from an External Memory Inserted in the Touch" on page 23-24.

- When **Communicate with** is set to **Touch** and **Port** to **USB**, deletion of the data starts.
- When **Communicate with** is set to **Touch** and **Port** is set to **Ethernet**, the Target IP Address dialog box is displayed. Specify the IP address of the Touch, and then click **OK** to start deletion of the data. For details, refer to "To execute any function except project data download" on page 23-8.
- When **Communicate with** is set to **O/I Link Slave**, the Target Slave dialog box is displayed. Specify the slave station of the Touch to communicate with, and then click **OK** to start deletion of the data. If **Port** is set to **Ethernet**, specify the IP address of the master to be used. For details, refer to "To execute any function except project data download" on page 23-9.



If security is enabled in the Touch project, the Password Screen is displayed. Enter the password.

For details, refer to Chapter 21 "User Accounts and the Security Function" on page 21-1.

- 4 Click **Yes**.

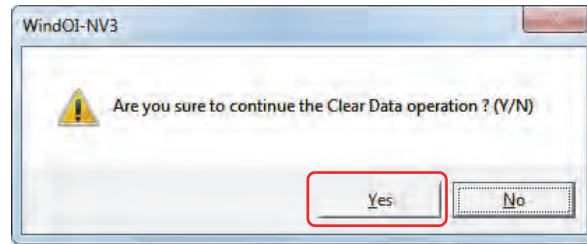

- 5 Click **Close**.

This concludes clearing data.

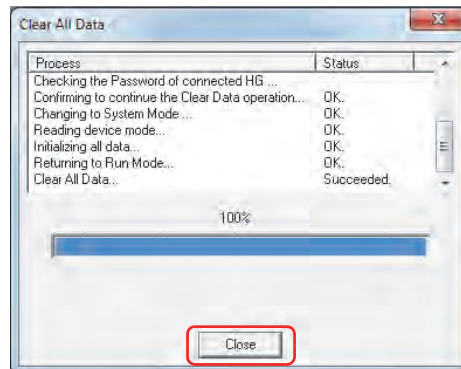

During communication with an O/I Link Slave using the online function, O/I Link Master operation is stopped.

4.2 Deleting Data from an External Memory Inserted in the Touch

- 1 Change communication settings according to the connection method between the computer and the Touch.

In the Communication Settings dialog box, select **Touch** from **Communicate with**. To communicate with the Touch as an O/I Link Slave via an O/I Link Master, select **O/I Link Slave**. For details, refer to "1.3 Change Communication Settings" on page 23-5.

- 2 Open project data.

- 3 On the **Online** tab, in the **Touch** group, click **Clear**, then click **Stored Data in External Memory**.

The Clear Data dialog box is displayed.

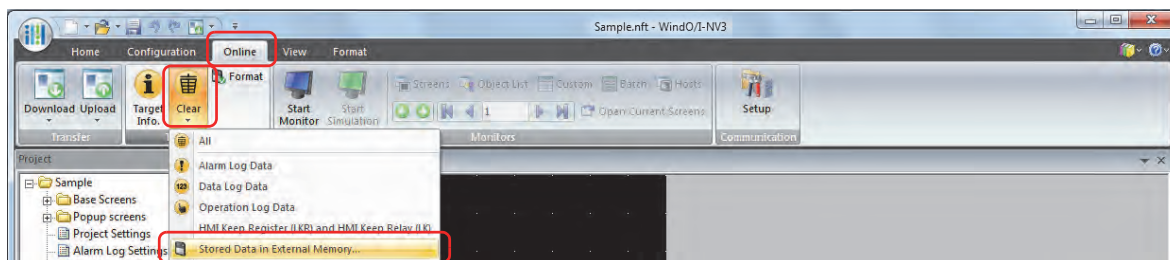

- 4 Select the check box for the data items to be deleted from the External Memory Folder.

Alarm Log Data, Data Log Data, Operation Log Data, and Recipe Files

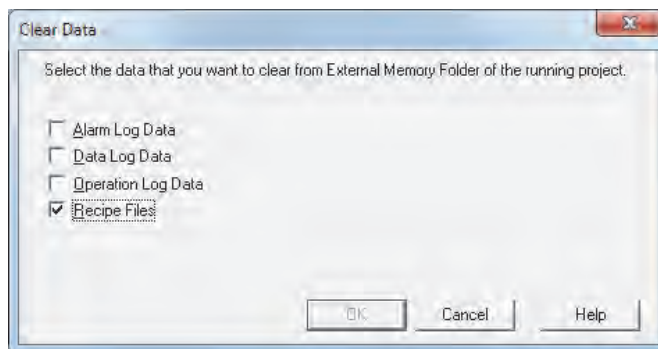

- 5 Click **OK**.

- When **Communicate with** is set to **Touch** and **Port** to **USB**, deletion of the data starts.
- When **Communicate with** is set to **Touch** and **Port** is set to **Ethernet**, the Target IP Address dialog box is displayed. Specify the IP address of the Touch, and then click **OK** to start deletion of the data. For details, refer to "To execute any function except project data download" on page 23-8.
- When **Communicate with** is set to **O/I Link Slave**, the Target Slave dialog box is displayed. Specify the slave station of the Touch to communicate with, and then click **OK** to start deletion of the data. If **Port** is set to **Ethernet**, specify the IP address of the master to be used. For details, refer to "To execute any function except project data download" on page 23-9.



If security is enabled in the Touch project, the Password Screen is displayed. Enter the password.
For details, refer to Chapter 21 "User Accounts and the Security Function" on page 21-1.

- 6 Click **Yes**.

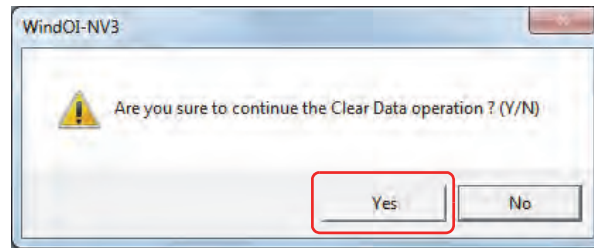

- 7 Click **Close**.

This concludes clearing data on the external memory.

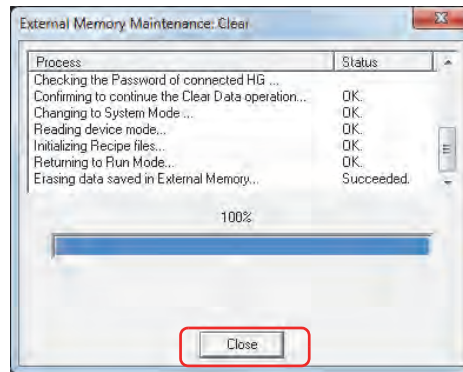

During communication with an O/I Link Slave using the online function, O/I Link Master operation is stopped.

5 Formatting

Stops operation of the Touch and formats an external memory inserted in the Touch.

5.1 Formatting an External Memory Inserted in the Touch

- 1 Change communication settings according to the connection method between the computer and the Touch.

If communicating with a Touch inserted in a computer, in the Communication Settings dialog box, select **Touch** from **Communicate with**. To communicate with the Touch as an O/I Link Slave via an O/I Link Master, select **O/I Link Slave**. For details, refer to "1.3 Change Communication Settings" on page 23-5.

- 2 Open project data.
- 3 On the **Online** tab, in the **Touch** group, click **Format**.

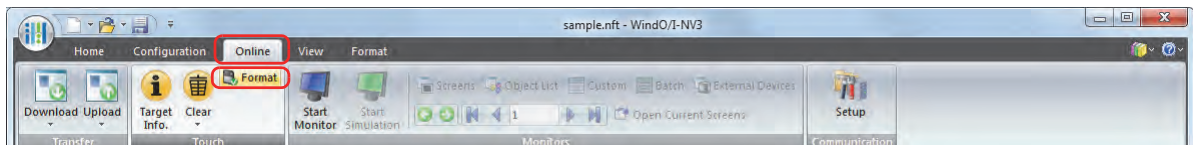

- When **Communicate with** is set to **Touch** and **Port** is set to **USB**, a formatting confirmation message is displayed.
- When **Communicate with** is set to **Touch** and **Port** is set to **Ethernet**, the Target IP Address dialog box is displayed. Specify the IP address of the Touch, and then click **OK** to display the formatting confirmation message. For details, refer to "To execute any function except project data download" on page 23-8.
- When **Communicate with** is set to **O/I Link Slave**, the Target Slave dialog box is displayed. Specify the slave station of the Touch to communicate with, and then click **OK** to display the formatting confirmation message. If **Port** is set to **Ethernet**, specify the IP address of the master to be used. For details, refer to "To execute any function except project data download" on page 23-9.



If security is enabled in the Touch project, the Password Screen is displayed. Enter the password. For details, refer to Chapter 21 "User Accounts and the Security Function" on page 21-1.

- 4 Click **Yes**.

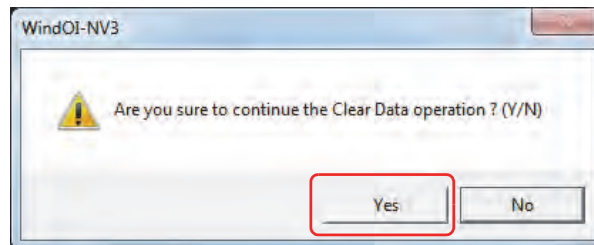

- 5 Click **Close**.

This concludes formatting the external memory.

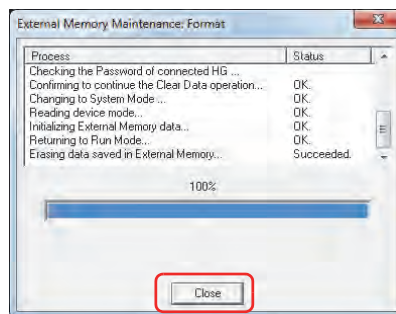

During communication with an O/I Link Slave using the online function, O/I Link Master operation is stopped.

6 System Information

Displays information about the runtime system and downloaded project data of the Touch.

This function can be used to show information about project data during editing and to simultaneously check details of project data downloaded to the Touch.

6.1 Displaying System Information

- 1 Change communication settings according to the connection method between the computer and the Touch.

If communicating with a Touch inserted in a computer, in the Communication Settings dialog box, select **Touch** from **Communicate with**. To communicate with the Touch as an O/I Link Slave via an O/I Link Master, select **O/I Link Slave**. For details, refer to “1.3 Change Communication Settings” on page 23-5.

- 2 On the **Home** tab, in the **Project** group, click **Target Info.**

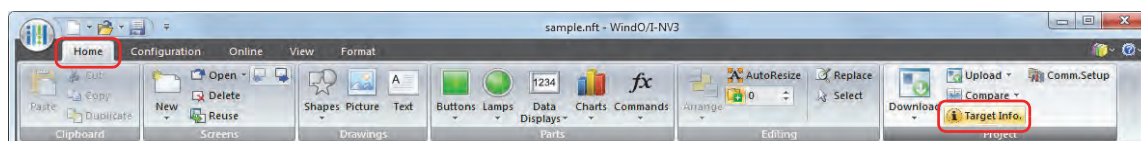

While editing project data, information about runtime system and project data can be displayed even by clicking **Target Info.** in the **Touch** group on the **Online** tab.

- When **Communicate with** is set to **Touch** and **Port** is set to **USB**, the System Information dialog box is displayed.
- When **Communicate with** is set to **Touch** and **Port** is set to **Ethernet**, the Target IP Address dialog box is displayed. Specify the IP address of the Touch, and then click **OK** to display the System Information dialog box. For details, refer to “To execute any function except project data download” on page 23-8.
- When **Communicate with** is set to **O/I Link Slave**, the Target Slave dialog box is displayed. Specify the slave station of the Touch to communicate with, and then click **OK** to display the System Information dialog box. If **Port** is set to **Ethernet**, specify the IP address of the master to be used. For details, refer to “To execute any function except project data download” on page 23-9.



If security is enabled in the Touch project, the Password Screen is displayed. Enter the password. For details, refer to Chapter 21 “User Accounts and the Security Function” on page 21-1.

3 Check information about the runtime system and project data.

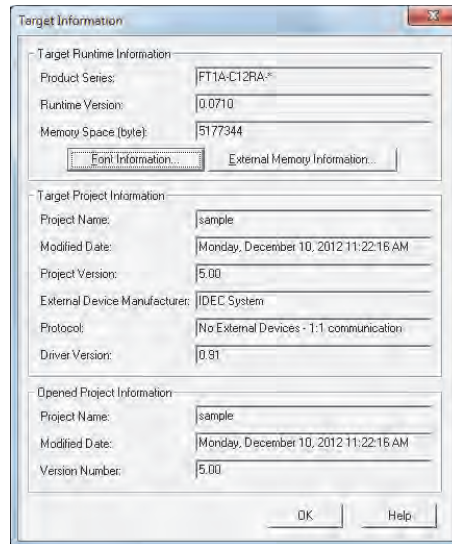

- To check the additional fonts installed on the Touch, click **Font Information**. The Font Information dialog box is displayed. For details, refer to “Font Information Dialog Box” on page 23-30.
- To check information about the external memory inserted in the Touch, click **External Memory Information**. The External Memory Information dialog box is displayed. For details, refer to “External Memory Information Dialog Box” on page 23-30.

4 When you have finished checking the information, click **OK**.

5 Click **Close**.

This concludes checking system information.

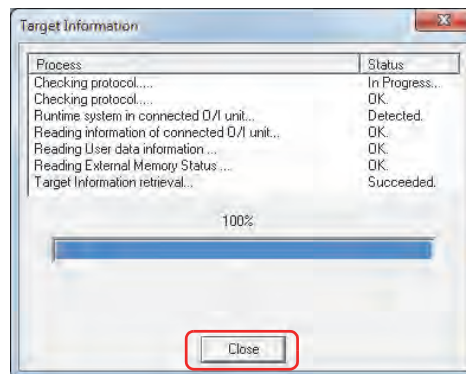

During communication with an O/I Link Slave using the online function, O/I Link Master operation is stopped.

6.2 Target Information Dialog Box

This section describes the settings and buttons of the Target Information dialog box.

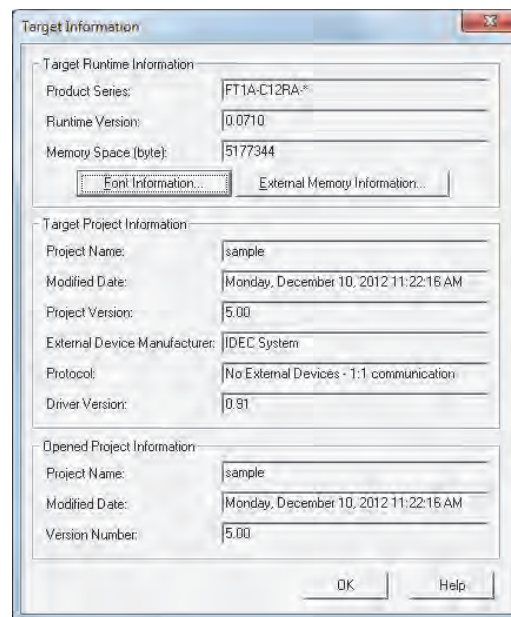

■ Target Runtime Information

- Product Series:** Shows the type number of Touch
- Runtime Version:** Shows the runtime system version of the Touch.
- Memory Space (byte):** Shows the maximum amount of project data (bytes) that can be downloaded to the Touch.
- Font Information:** Checks the additional fonts currently installed on the Touch. Click this button to display the Font Information dialog box. For details, refer to “Font Information Dialog Box” on page 23-30.
- External Memory Information:** Checks the state of an external memory inserted in the Touch, its total capacity, available capacity, and used capacity. Click this button to display the External Memory Information dialog box. For details, refer to “External Memory Information Dialog Box” on page 23-30.

■ Target Project Information

- Project Name:** Shows the project name of projects downloaded to the Touch.
- Modified Date:** Displays the time that project data downloaded to the Touch was last saved in WindO/I-NV3.
- Project Version:** Displays the version of WindO/I-NV3 used to create the project data downloaded to the Touch.
- External Device Manufacturer:** Displays the external device manufacturer configured in the project downloaded to the Touch.
- Protocol:** Displays the communication driver configured in the project downloaded to the Touch.
- Driver Version:** Displays the version of the communication driver.

■ Opened Project Information

- Project Name:** Shows the project name of the project being edited.
- Modified Date:** Displays the time that the project being edited was last saved in WindO/I-NV3.
- Version Number:** Displays the version of WindO/I-NV3 used to create the project being edited.



This function can be used to show information about a project that is being edited and simultaneously check information about project data downloaded to the Touch.

Font Information Dialog Box

This dialog box is used to check the state of installed additional fonts.

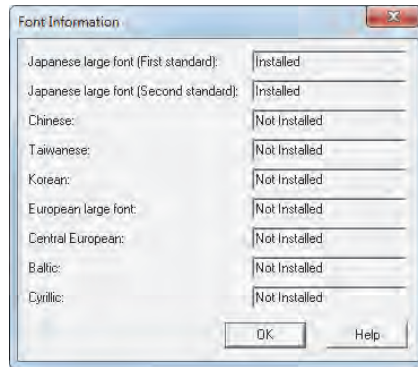

The installation status of each additional font is shown to the right of the font. The following additional fonts can be installed.

- Japanese Large Font (First standard)
- Japanese Large Font (Second standard)
- Chinese
- Taiwanese
- Korean
- European Large Font
- Central European
- Baltic
- Cyrillic

External Memory Information Dialog Box

Checks the state of an external memory inserted in the Touch, its total capacity, available capacity, and used capacity.

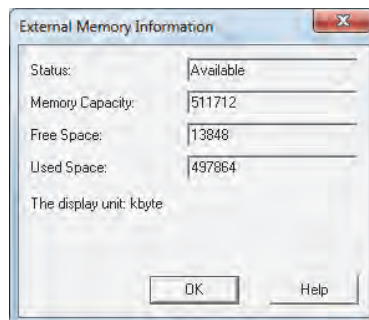

- State:** Shows the state of the external memory inserted in the Touch.
- Memory Capacity:** Shows the total capacity (bytes) of the external memory inserted in the Touch.
- Free Space:** Shows how much of the capacity (bytes) of the external memory inserted in the Touch is currently available for use.
- Used Space:** Shows how much of the capacity (bytes) of the external memory inserted in the Touch is currently in use.

Chapter 24 Monitor Function

This chapter describes the monitor function that checks operation of the created project data.

Monitor function enables the values of internal devices and the values of external devices to be checked and changed. This can be done in two ways: using WindO/I-NV3 on a computer connected to the Touch, or directly on the screen of the Touch.

1 Monitoring with WindO/I-NV3

1.1 How the Monitor Function in WindO/I-NV3 is Used

Monitor function in WindO/I-NV3 can be performed as follows.

- Checking values of devices used on the screen of the Touch

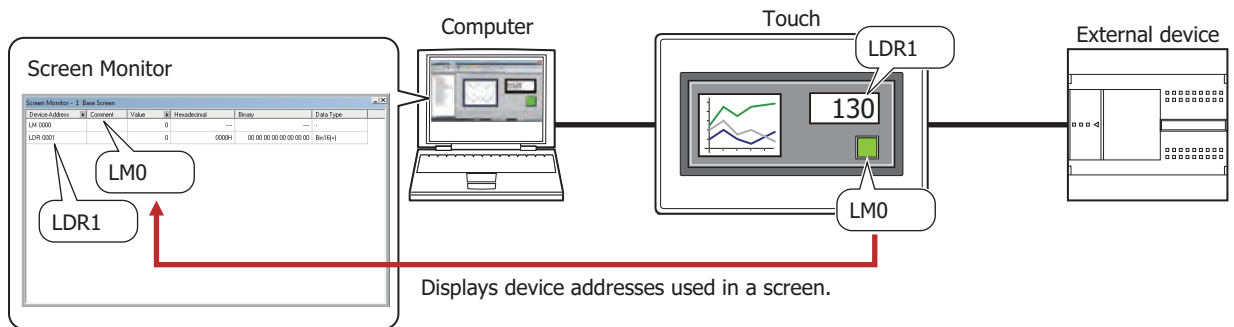

- Checking values of specified devices

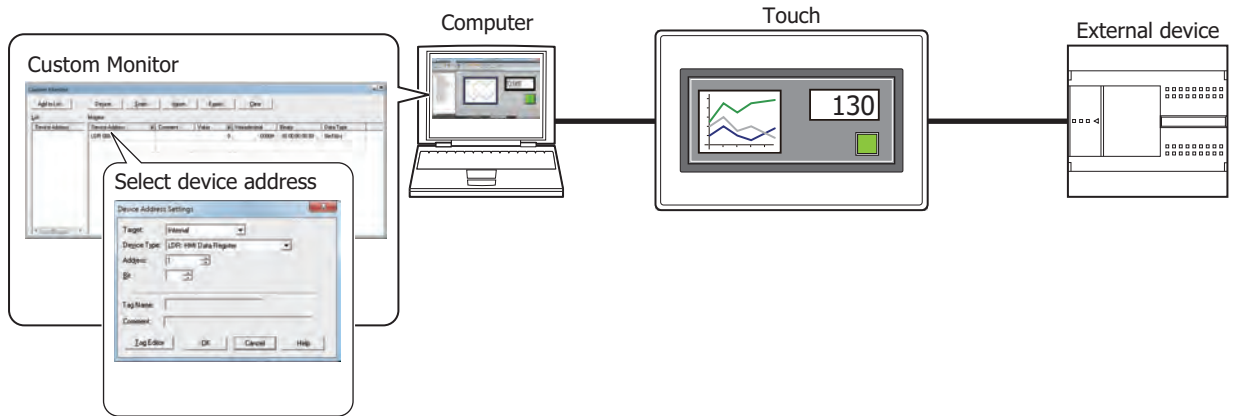

- Checking values of devices of sequential addresses

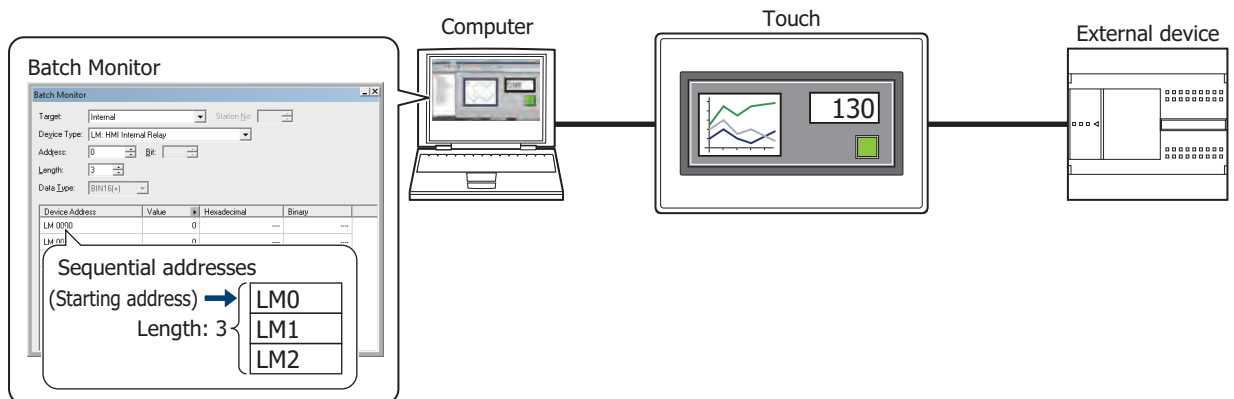

- Checking the state of external devices connected to the Touch

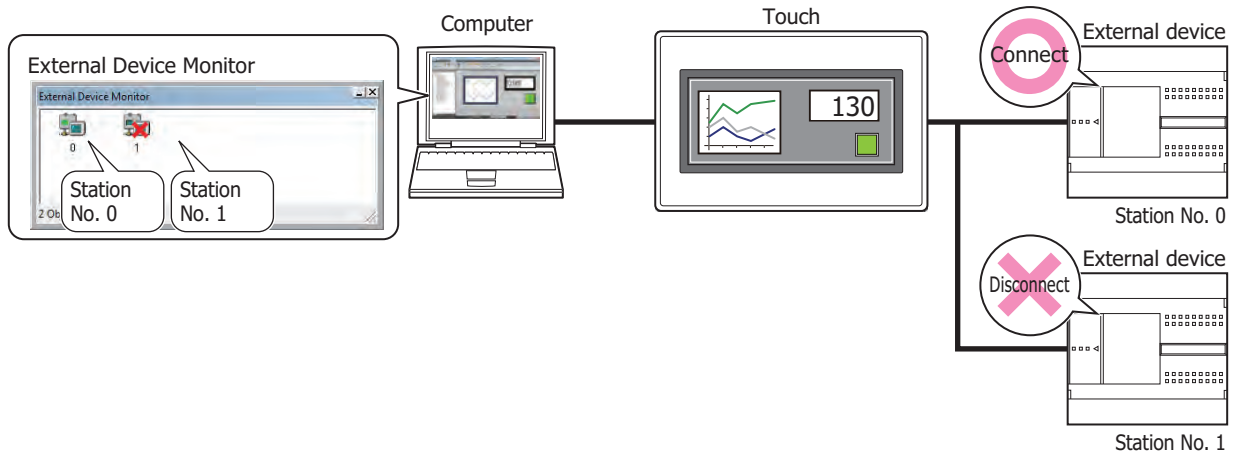

- Displaying the value of device in a popup

Object List window

No.	Name	Type	Device	Trigger Type
1	BitButton1	Bit Button	D 00000-00	6: While satisfying th
2	BitButton2	Bit Button	LM 0000	3: Always Enabled

LM 0000 = 0
Popup

Script Editor

```

Script ID: 10
Script Name:
Script:
if( [LBR 000] < 15 ){
[LBR 000] = [LBR 000] + 1;
}else{
[LBR 000] = 0;
}
                    
```

0 (0000H)
Popup

- Highlighting objects while satisfying conditions

✖
Not satisfied
Condition

No.	Name	Type	Device	Trigger Type	Trigger Condition	Text ID
1	BitButton1	Bit Button	LDR 0000-00	6: While satisfying the condition	[LM 0000] == 1	
2	BitButton2	Bit Button	LM 0000	3: Always Enabled		

✔
Satisfied
Condition

Trigger Condition
While satisfying the condition: LM0==1

Device Address	Comment	Value
LM 0000		0

LMO = →

Highlighted

- Switching to the screen of the Touch

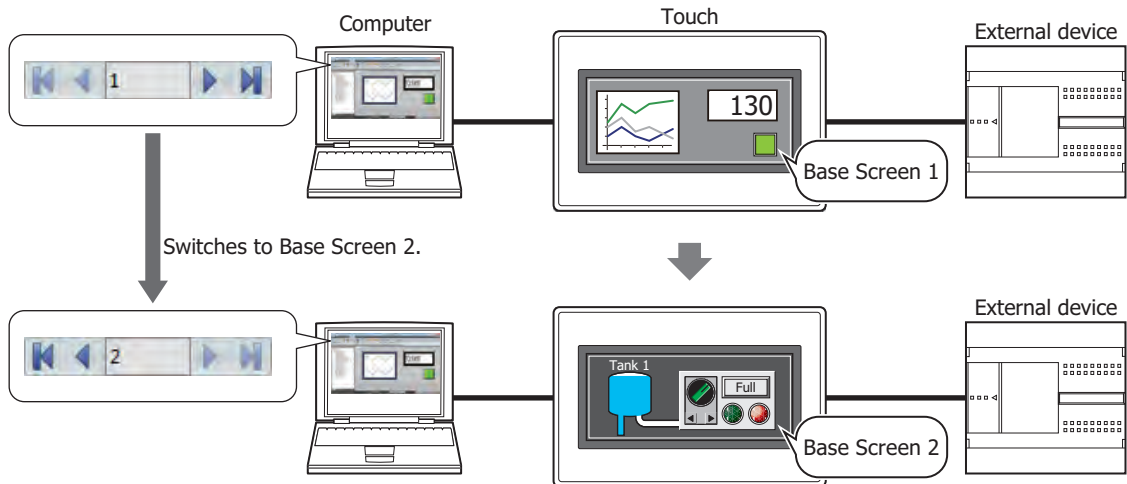

- Opening current screen

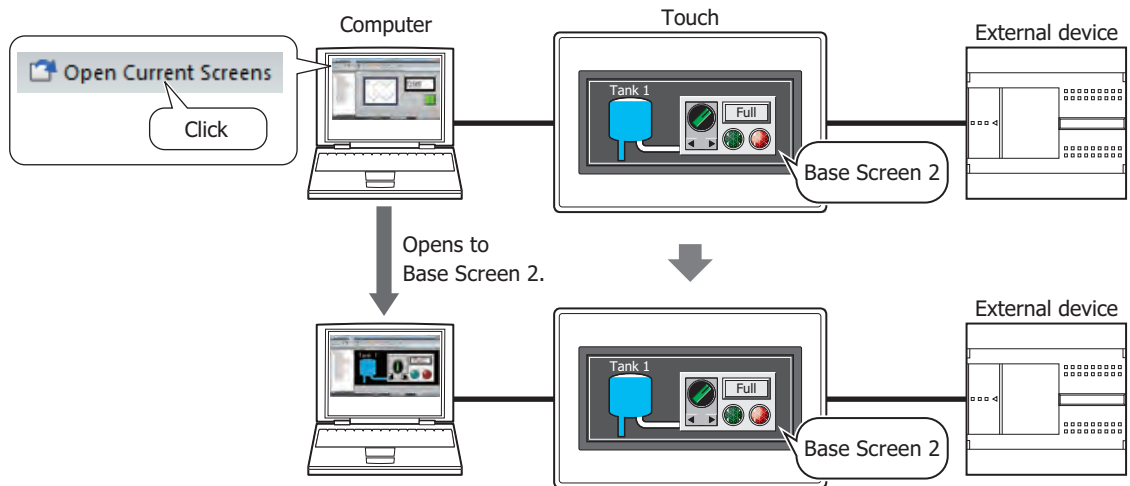

Monitor function in WindLDR can be performed as follows.

- Monitoring the ladder program
 - ☞ refer to Chapter 12 "Monitor Operation" on page 12-12
- Monitoring the FBD program
 - ☞ refer to Chapter 12 "Monitor Operation" on page 12-38

1.2 Debugging in WindO/I-NV3

This section describes the procedure for monitoring values of devices and debugging in WindO/I-NV3.

- 1 Change the communication setting to match the connection method between computer and Touch.
For details, refer to Chapter 23 "1.3 Change Communication Settings" on page 23-5.

- 2 On the **Online** tab, in the **Monitors** group, click **Start Monitor**.

The Touch switches to monitor mode and **Monitor Mode** is displayed at the bottom left of the screen.

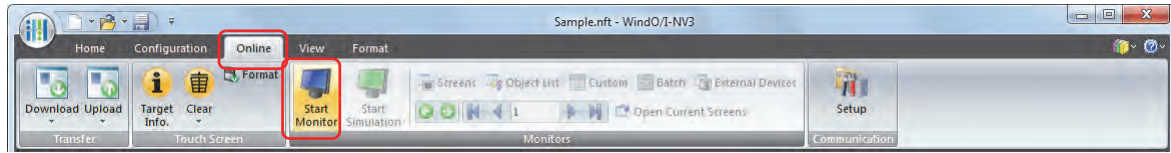

If a password has been configured for the project data, the Enter Password screen will be displayed. Enter the password. For details, refer to Chapter 21 "User Accounts and the Security Function" on page 21-1.

- 3 On the **Online** tab, in the **Monitors** group, click the following button or enter the number to the text box to switch the screen displayed on the Touch to the Monitor screen.

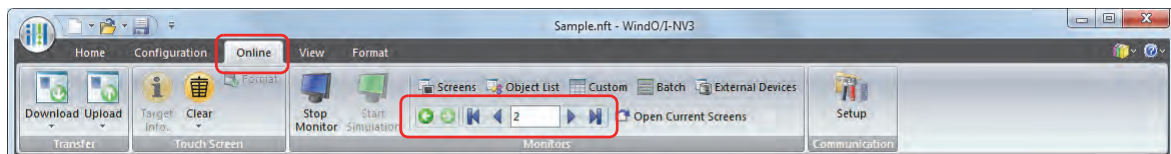

-  **(Back)**

You are returned to the Base Screen that was displayed immediately before the screen was switched.

-  **(Forward)**

Advances to the Base Screen that was displayed immediately before the screen was switched using  **(Back)**.

-  **(First Screen)**

Switches to the Base Screen of the lowest screen number in the project data.

-  **(Previous Screen)**

Switches to the Base Screen of screen number one lower than the Base Screen currently displayed. If the screen numbers are not sequential, switches to the screen of next lowest number.

- **(Specified Screen)**

Switches to the Base Screen with the specified number.

-  **(Next Screen)**

Switches to the screen with screen number one higher than the Base Screen currently displayed. If the screen numbers are not consecutive, switches to the screen of next highest number.

-  **(Last Screen)**

Switches to the Base Screen of highest screen number in the project data.

- 4 On the **Online** tab, in the **Monitors** group, click **Open Current Screens**.

The screen displayed on Touch opens in the editing window.

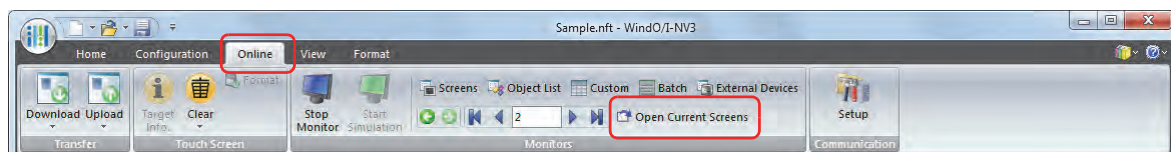

- 5 On the **Online** tab, in the **Monitors** group, select the monitor being used.

When monitoring starts, the screen monitor is displayed.

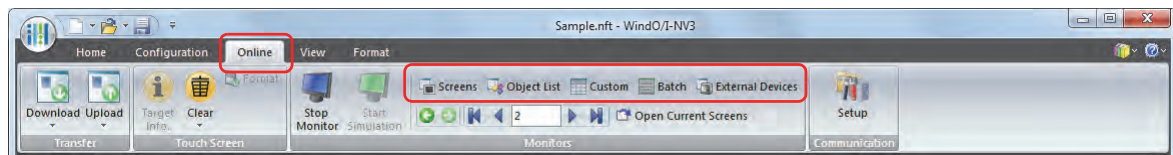

■ Screens

Automatically checks device addresses used on the screen displayed on the Touch. For details, refer to “Screen Monitor” on page 24-6.

■ Object List

Displays values of devices in a popup on the **Object List** window. It also highlights objects while satisfying conditions. For details, refer to “1.3 Display the Value of Device in Popup” on page 24-16, and “1.4 Highlighting Objects While Satisfying Conditions” on page 24-16.

■ Custom

Registers monitored devices individually and displays the value of devices. For details, refer to “Custom Monitor” on page 24-7.

■ Batch

Registers monitored devices as a batch for sequential addresses and displays the value of devices. For details, refer to “Batch Monitor” on page 24-14.

■ External Devices

Displays the state of external devices connected to the Touch. For details, refer to “External Device Monitor” on page 24-15.

- 6 Check operation of project data by monitoring and changing values of devices, and edit project data if there is an error.

If the monitored screen is switches, repeat steps 3 through 4.

- 7 Download the edited project data to the Touch.



To reflect edits made during debugging, it is necessary to perform a download.

- 8 On the **Online** tab, in the **Monitors** group, click **Stop Monitor**.

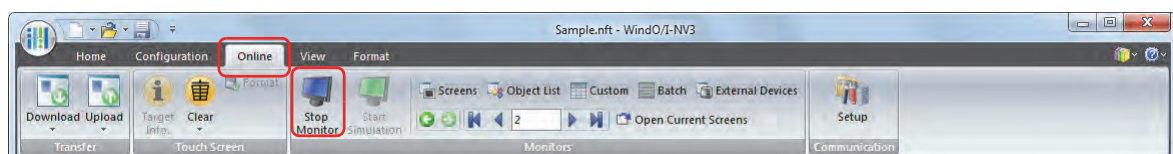

● **Screen Monitor**

Automatically displays device addresses used on the screen displayed on the Touch. Enables values of devices to be monitored and changed.

Device Address	Comment	Value	Hexadecimal	Binary	Data Type
LSD 051		31	001FH	00 00 00 00 00 01 11 11	Bin16(+)
LBR 020		60	003CH	00 00 00 00 00 11 11 00	Bin16(+)
LBR 012		90	005AH	00 00 00 00 01 01 10 10	Bin16(+)
LBR 011		0	0000H	00 00 00 00 00 00 00 00	Bin16(+)
LBR 010		128	0080H	00 00 00 00 10 00 00 00	Bin16(+)
LBR 004		0	0000H	00 00 00 00 00 00 00 00	Bin16(+)
LBR 003		33	0021H	00 00 00 00 00 10 00 01	Bin16(+)
LBR 002		21	0015H	00 00 00 00 00 01 01 01	Bin16(+)
LBR 001		3513	0DB9H	00 00 11 01 10 11 10 01	Bin16(+)
LBR 000		12345	3039H	00 11 00 00 00 11 10 01	Bin16(+)
LSM 01		0	----	----	-
LBM 020		0	----	----	-

■ **Device Address**

Displays the device addresses used on the screen displayed on the Touch.

▶ next to **Comment** toggles between showing and hiding comments. When comments are displayed, click ▶ to display a popup menu, then click **Comment** and select the check box.

■ **Comment**

Displays comments on device addresses saved in Tag Editor. Comments are displayed only after you click ▶ next to **Device Address** to display a popup menu, then click **Comment** and select the check box.

■ **Value**

Displays the current value of device address in decimal format. To change a value, double-click a cell and then specify a value.

The value range depends on the data type. For details, refer to Chapter 2 "1.1 Available Data" on page 2-1.

Click ▶ to toggle display of **HEX** and **BIN** format. To display **HEX** and **BIN** values, click ▶ to display a popup menu, then click **HEX and BIN** and select the check box.

■ **Hexadecimal, Binary**

Displays the current value of device address in hexadecimal and binary format. To change a value, double-click a cell and then specify a value.

The value range depends on the data type. For details, refer to Chapter 2 "1.1 Available Data" on page 2-1.

Comments are displayed only after you click ▶ next to **Value** to display a popup menu and then select the **HEX** and **BIN** check box.

■ **Data Type**

Selects the data type of the selected value. For details, refer to Chapter 2 "1.1 Available Data" on page 2-1.



- The values of device addresses configured as write-only, such as destination device address for bit buttons, cannot be monitored. "?????" is displayed in this case.
- If **BIN32**, **BCD8**, or **float32** is selected from **Data Type** for the address of highest number, the values stored in the device address are displayed repeatedly.
- If **BIN32**, **BCD8**, or **float32** is selected from **Data Type**, sequential addresses (lower word to upper word) are used.

● Custom Monitor

Enables the values of registered device addresses to be monitored and changed.

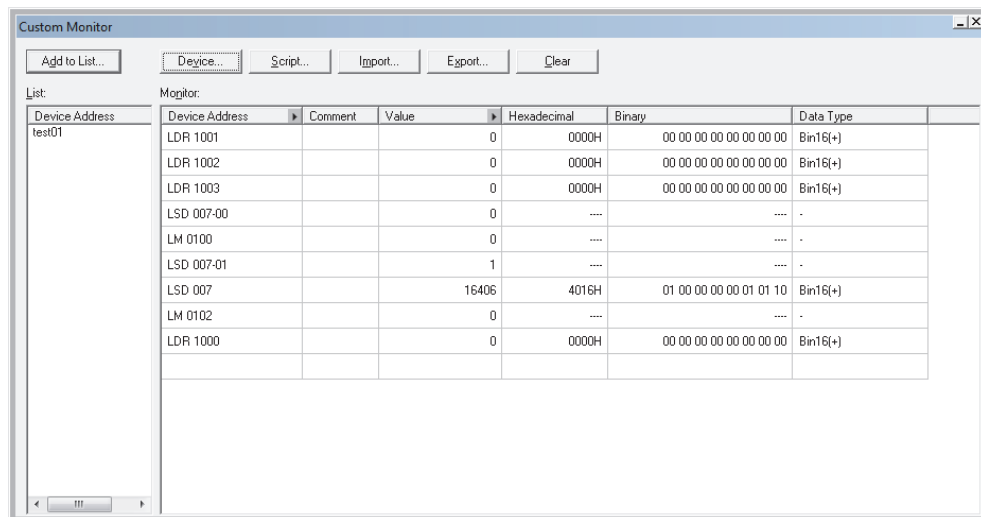

■ Add to List

Saves device addresses registered in **Monitor** to project data as a custom monitor list. A saved lists can be monitored by selecting it from the List.

Click this button to display the Device List Name Setting dialog box. For details, refer to “Saving Registered Device Addresses to Project Data as a Custom Monitor List” on page 24-10.

■ Device

Registers the device addresses to monitor individually.

Click this button to display the Device Address Settings dialog box. For details, refer to “Registering the device addresses to monitor individually” on page 24-8.

■ Script

Batch saves all device addresses used in a script.

Click this button to display Script Manager. For details, refer to “Batch Saving Device Addresses Used in Scripts” on page 24-9.

■ Import

Imports the device addresses from a device list saved as a CSV text file.

Click this button to display the Open dialog box. For details, refer to “Importing Devices from a Device List” on page 24-12.

■ Export

Saves the device addresses displayed in **Monitor** as a CSV text file. This file is called a Device List.

Click this button to display the Save As dialog box. For details, refer to “Saving a Custom Monitor List as a CSV File” on page 24-11.

The saved device list can be imported using **Import**.

■ Clear

Deletes all the device addresses displayed in **Monitor**.

■ List

Displays a custom monitor list saved with the project data.

Select a list to clear the device addresses shown in **Monitor** and display the device addresses in the list.

Double-click a cell to display the Device List Name Setting dialog box. The name of the custom monitor list can be edited.

Select a list and press DELETE to delete it from the List.



Monitor

The registered device addresses are displayed in a list.

Select the custom monitor list from the List to show the device addresses registered in the list.

Device Address: The registered device addresses are displayed.



Double-click a cell to register or change a device address. Click  to display the Device Address Settings dialog box. For details on how to configure device address settings, refer to Chapter 2 "5.1 Device Address Settings" on page 2-61.

 toggles between showing and hiding comments. When comments are displayed, click  to display a popup menu, then click **Comment** and select the check box.

Comment: Displays comments on device addresses saved in Tag Editor. Comments are displayed only after you click  next to **Device Address** to display a popup menu, then click **Comment** and select the check box.

Value: Displays the current value of device address in decimal format. To change a value, double-click a cell and then enter a value.

The value range depends on the data type. For details, refer to Chapter 2 "1.1 Available Data" on page 2-1.

Click  to toggle display of **HEX** and **BIN** format. To display **HEX** and **BIN** values, click  to display a popup menu, then click **HEX and BIN** and select the check box.

Hexadecimal, Binary: Displays the current value of device address in hexadecimal and binary format. To change a value, double-click a cell and then specify a value.

The value range depends on the data type. For details, refer to Chapter 2 "1.1 Available Data" on page 2-1.

Comments are displayed only after you click  next to **Value** to display a popup menu and then select the **HEX** and **BIN** check box.

Data Type: Selects the data format of the displayed value. For details, refer to Chapter 2 "1.1 Available Data" on page 2-1.



- If **BIN32**, **BCD8**, or **float32** is selected from **Data Type** for the address of highest number, the values stored in the device address are displayed repeatedly.
- If **BIN32**, **BCD8**, or **float32** is selected from **Data Type**, sequential addresses (lower word to upper word) are used.

Registering the device addresses to monitor

Registering the device addresses to monitor individually

Click **Device**. Or, double-click a cell under **Device Address** in **Monitor**, and then click .

The Device Address Settings dialog box is displayed. For details on configuring device address settings, refer to Chapter 2 "5.1 Device Address Settings" on page 2-61.

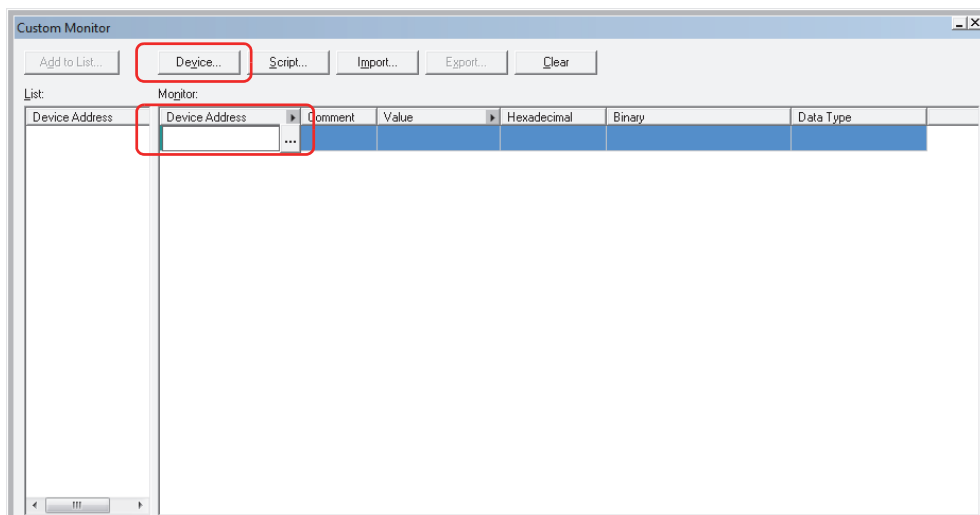

Batch Saving Device Addresses Used in Scripts

1 Click **Script**.

Script Manager is displayed.

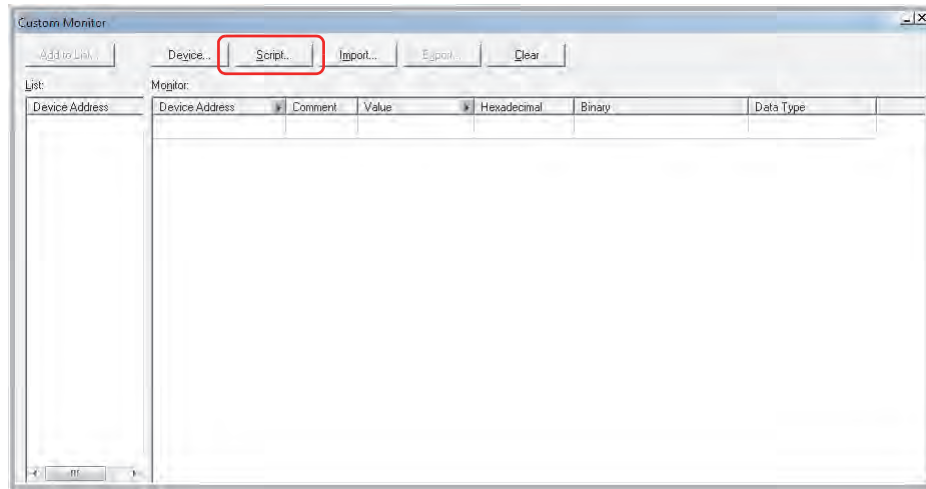

2 Select the script ID of the script for the device address to be batch-saved, and then click **Select**.

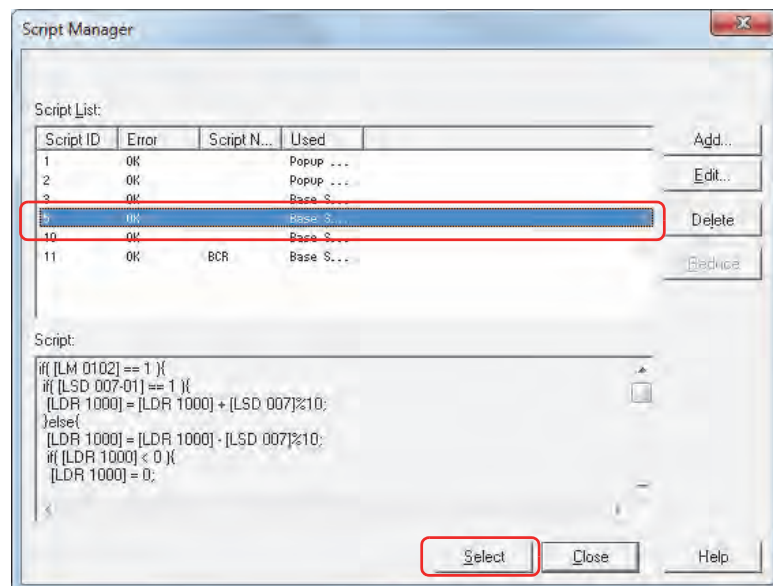

All the device addresses used by the script are registered.

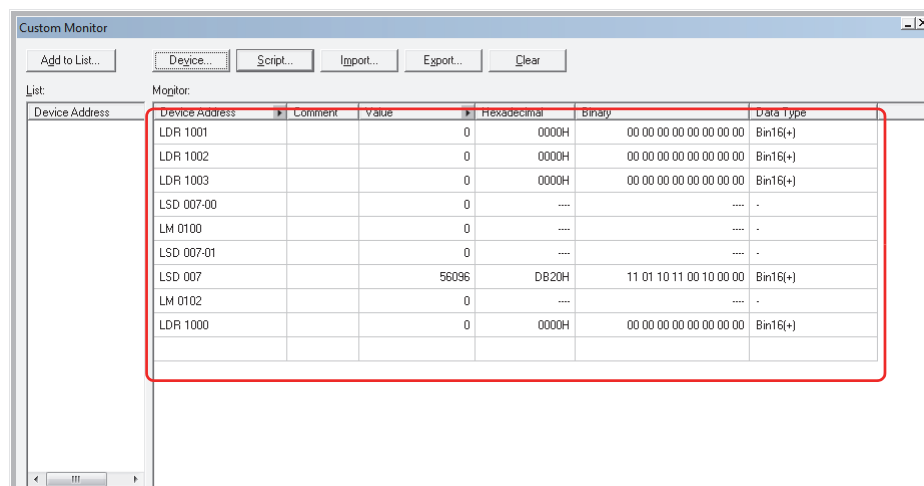

Saving Registered Device Addresses to Project Data as a Custom Monitor List

If registered device addresses are saved with project data as a list, then even when the project data is later reopened, the device addresses can be called from the List to be reutilized.

1 Click **Add to List**.

The Device List Name Setting dialog box is displayed.

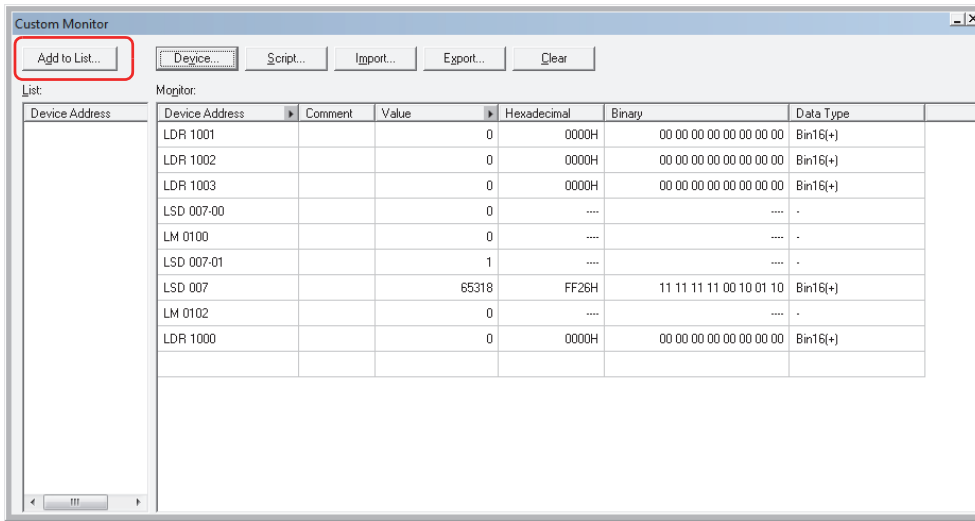

2 Enter a name for the custom monitor list.

The maximum number is 40 characters. Only alphanumeric characters and symbols can be used.



The following characters cannot be used for names of custom monitor list.

\\ : * ? " < > |

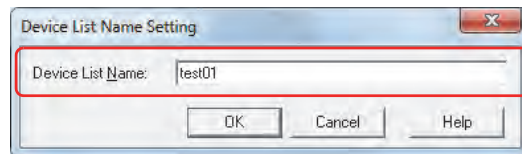

3 Click **OK**.

The custom monitor list is added to the **List**.

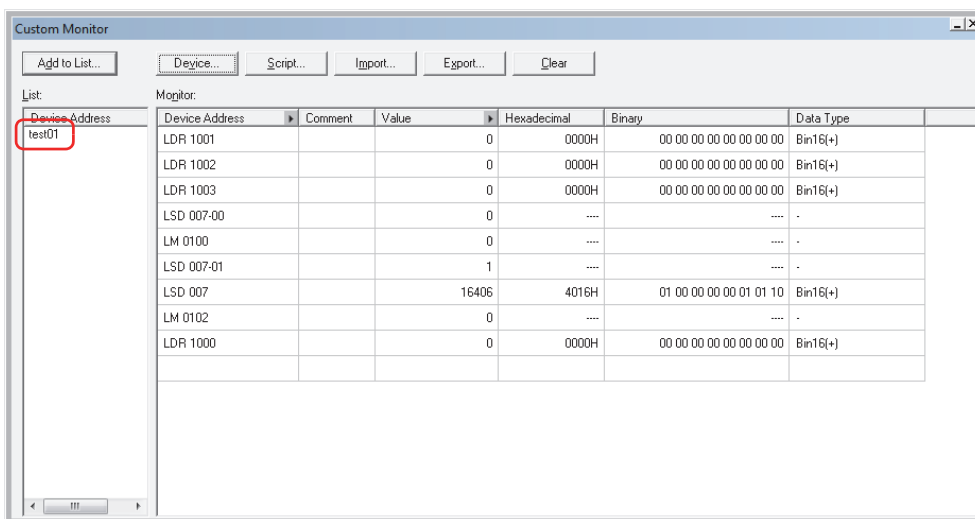

4 Saving project data.



If a project file is closed without saving, custom monitor lists will not be saved with the project data.

Saving a Custom Monitor List as a CSV File

To use a custom monitor list (registered devices list) in another project, save it as a CSV text file. This file is called a Device List.

1 Click **Export**.

The Save As dialog box is displayed.

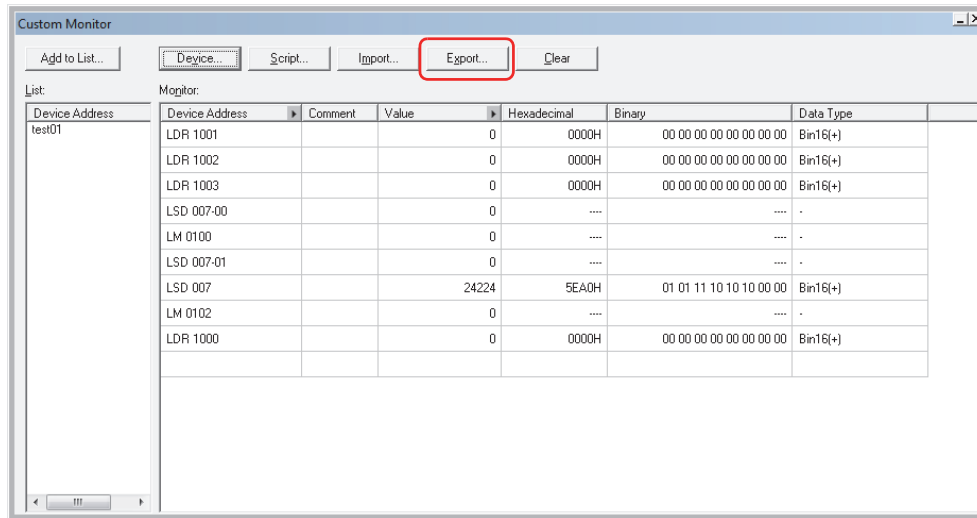

2 Select **Save in**, enter a **File name**, and then click **Save**.

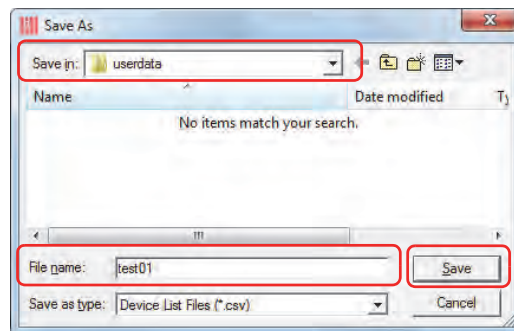

This concludes saving device list.

Importing Devices from a Device List

Imports the device addresses from a device list saved as a CSV text file into custom monitor.

- 1 Click **Import**.

The Device List dialog box is displayed.

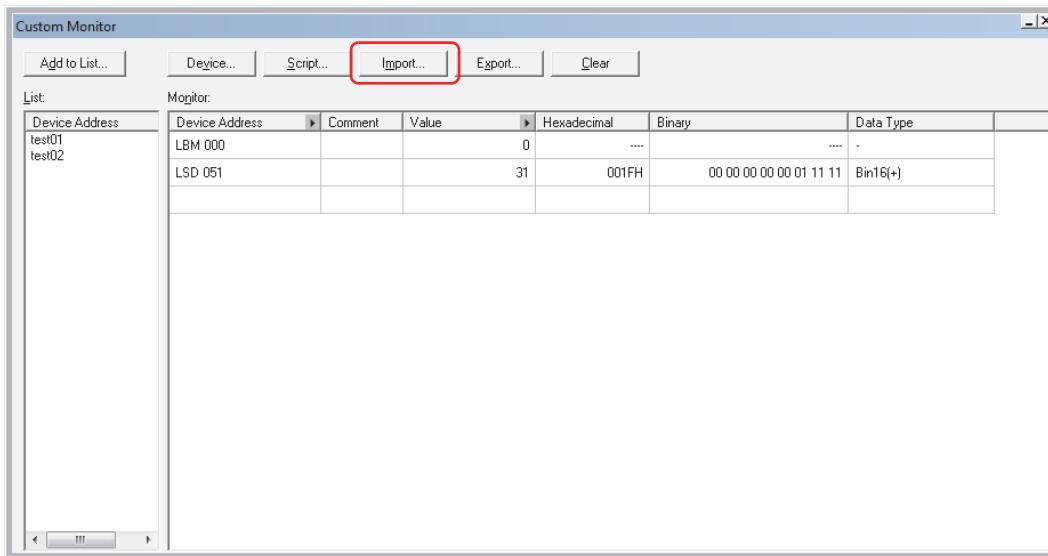

- 2 Click .

The Open dialog box is displayed.

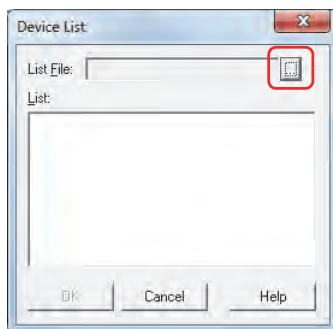

- 3 Select a saved device list, and then click **Open**.

The device addresses are listed.

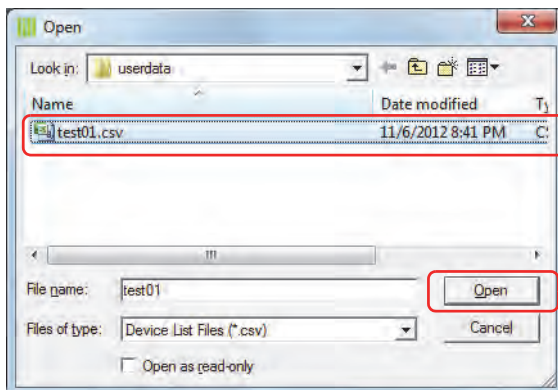

- 4 Click the device address to import.



To select multiple items of text, press and hold SHIFT or CTRL while you click the specific items.

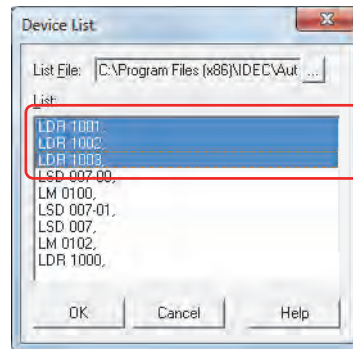

- 5 Click **OK**.

If there is an already registered device address on the Custom Monitor, an overwrite confirmation message is displayed.

- Click **Yes** to overwrite the device address displayed in the confirmation message.
- Click **Yes To All** to overwrite all the device addresses.
- Click **No** to display the next confirmation message without overwriting the device address displayed in the confirmation message.
- Click **Cancel** to stop importing device addresses.

The device is added to **Monitor**.

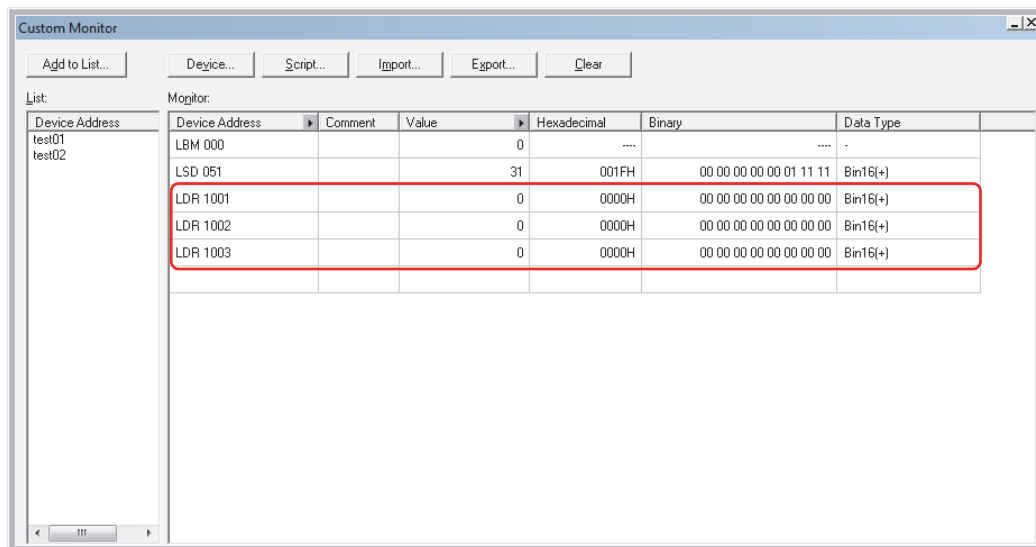

● **Batch Monitor**

Displays sequential addresses as a batch.

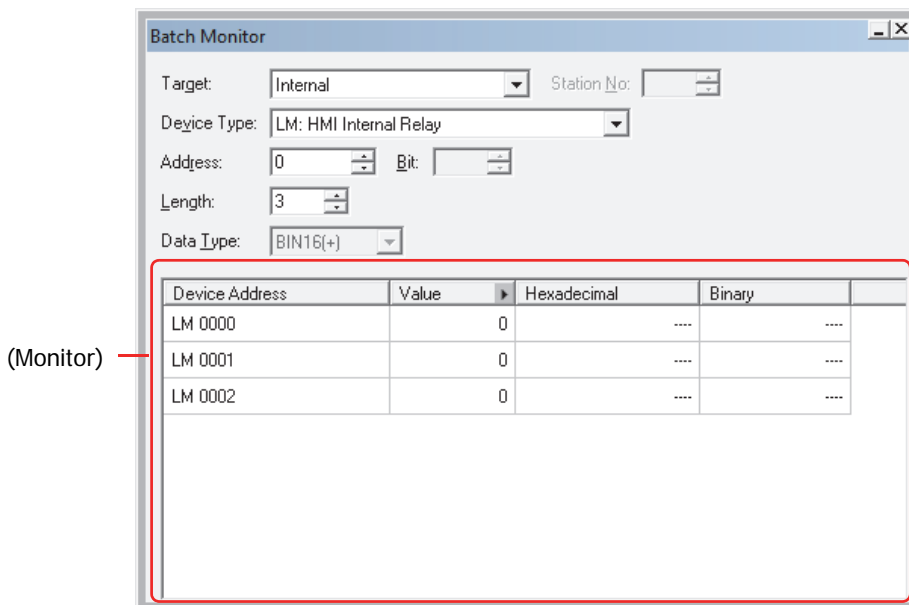

■ **Target**

Select **Touch** or **External Devices** from the device addresses that include the device addresses to be set.

■ **Station No.**

Specify the station number of the external device. The range of possible settings can be varies according to the selected communication drivers.

This option can only be configured when **1:N Communication** is selected under **Connection** in the Select Communication Driver dialog box or the Change Communication Driver dialog box.

■ **Device Type**

Selects the device type.

The list only shows device types that can be used.

■ **Address**

Specify the address. The range that can be set varies based on the device type selected.

■ **Bit**

Specify the bit (0 to 15) of the word device when a word device is selected in **Device**.

■ **Length**

Specifies the number of device addresses displayed in the list (Bit of the word device specification: 1 to 16, Other than above: 1 to 1000).

■ **Data Type**

Selects the data format of the displayed value. For details, refer to Chapter 2 "1.1 Available Data" on page 2-1.

■ **(Monitor)**

Automatically displays the selected device addresses, in the number specified under **Length**, from top to bottom, consecutively.

Device Address:

The specified device addresses are displayed.

► toggles between showing and hiding comments. When comments are displayed, click ► to display a popup menu, then click **Comment** and select the check box.

Value:

Displays the current value of device address in decimal format. To change a value, double-click a cell and then specify a value.

The value range depends on the data type. For details, refer to Chapter 2 "1.1 Available Data" on page 2-1.

Click ► to toggle display of **HEX** and **BIN** format. To display **HEX** and **BIN** values, click ► to display a popup menu, then click **HEX and BIN** and select the check box.

Hexadecimal, Binary: Displays the current value of device address in hexadecimal and binary format. To change a value, double-click a cell and then specify a value.
 The value range depends on the data type. For details, refer to Chapter 2 "1.1 Available Data" on page 2-1.
 Comments are displayed only after you click  next to **Value** to display a popup menu and then select the **HEX** and **BIN** check box.



- If **BIN32**, **BCD8**, or **float32** is selected from **Data Type** for the address of highest number, the values stored in the device address are displayed repeatedly.
- If **BIN32**, **BCD8**, or **float32** is selected from **Data Type**, sequential addresses (lower word to upper word) are used.

● External Device Monitor

Displays the state of external devices connected to the Touch.
 Can be used only for 1:N communication devices.

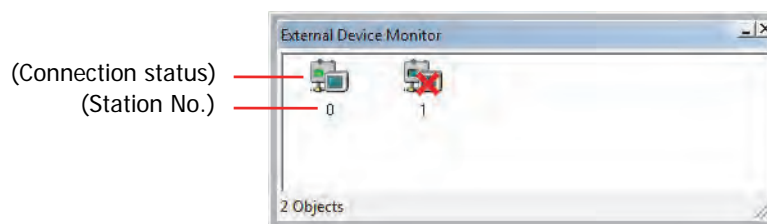

■ (Connection status)

Displays the state of external devices connected to the Touch. If a red cross appears over the icon of an external device () , communication is stopped.
 Clicking the external device icon enables switching between connection and disconnection.

■ (Station No.)

Displays the station number of all external devices used in the project.

1.3 Display the Value of Device in Popup

During monitoring, mousing over device addresses displayed in the **Object List** window or device addresses in a script opened in Script Editor displays the current value in a popup window.

- **Object List** window

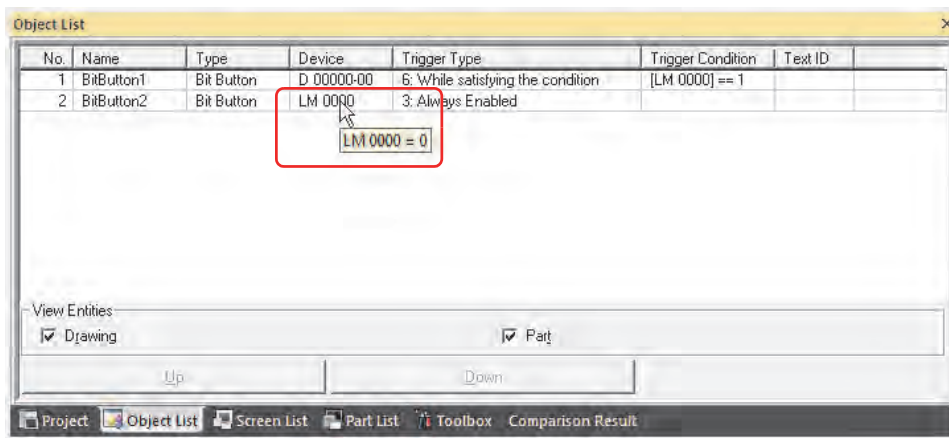

- Script Editor

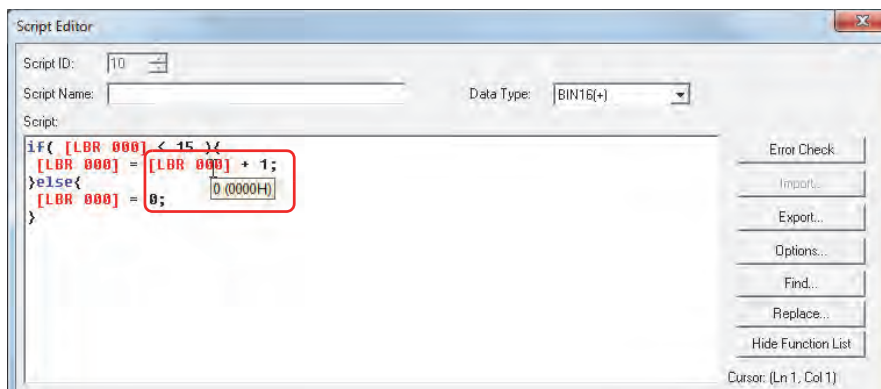

- Popup viewing of values of devices in the **Object List** window works only if the screen displayed in the **Object List** window matches the screen displayed on the Touch.
- Popup viewing of values of devices in Script Editor works only if the script during editing is being used by a global script command or a script command on the screen displayed on the Touch.
- The maximum number for popup window is 80 characters. Any characters entered after the 80th will not be displayed.
- If 65 or more device addresses are displayed in the **Object List** window, monitor refreshing and popup message will slow down.

1.4 Highlighting Objects While Satisfying Conditions



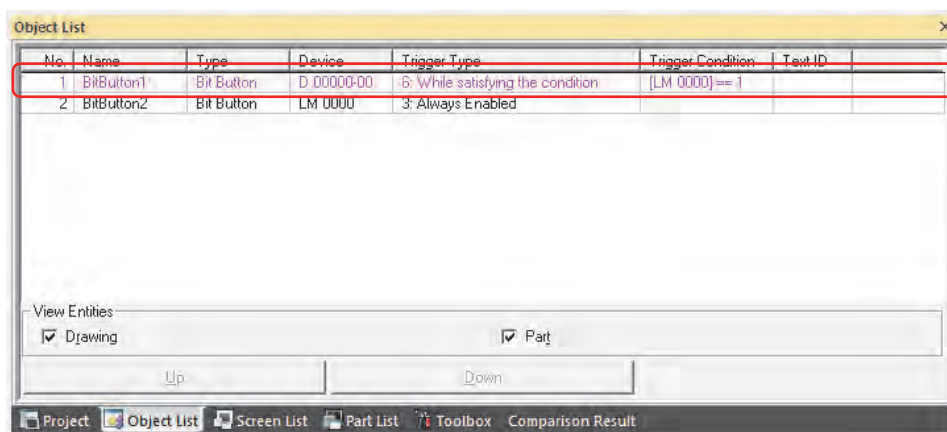



When the Trigger Condition is satisfied during monitoring, the objects for which conditions are being satisfied are highlighted in the **Object List** window.

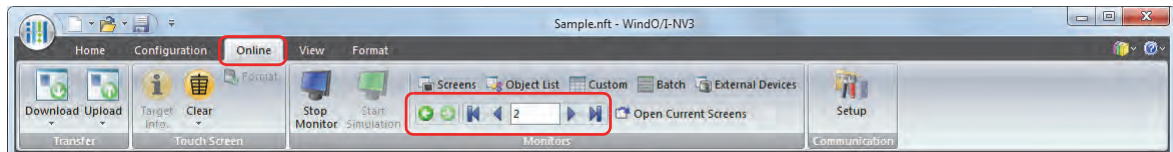

1.5 Switching the Screen of the Touch

During monitoring, it is possible to switch to the screen displayed on the Touch using a WindO/I-NV3 command.



-  **(Back)**
You are returned to the Base Screen that was displayed immediately before the screen was switched.
-  **(Forward)**
Advances to the Base Screen that was displayed immediately before the screen was switched using the  **(Back)**.
-  **(First Screen)**
Switches to the Base Screen with the lowest screen number in the project data.
-  **(Previous Screen)**
Switches to the Base Screen of screen number one lower than the Base Screen currently displayed. If the screen numbers are not consecutive numbers, this command switches to the closest number.
- **(Specified Screen)**
Switches to the Base Screen of a specified number.
-  **(Next Screen)**
Switches to the Base Screen of screen number one higher than the Base Screen currently displayed. If the screen numbers are not consecutive numbers, switches to the closest number.
-  **(Last Screen)**
Switches to the Base Screen of highest screen number in the project data.

1.6 Open Current Screens

To automatically open the screen displayed on the Touch during monitoring and put it into an active state, click **Open Current Screens**.

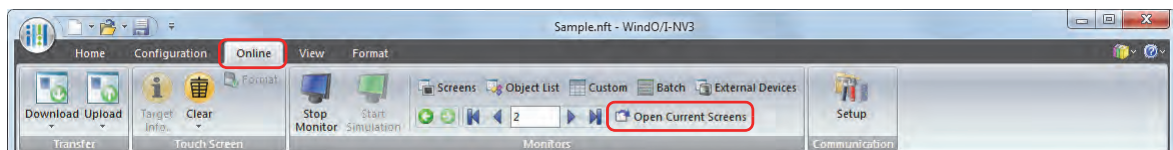

2 Monitoring on the Touch

It is possible to change values of devices and check the operation on the Touch, without connecting to a computer.

2.1 How the Monitoring Function is Used

Monitoring in the Touch can perform the following functions.

- Checking and changing the value of specified device

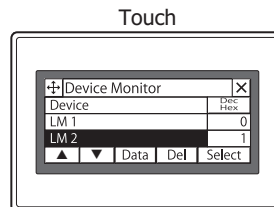

- Checking ladder program

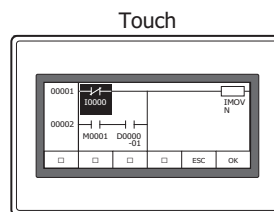

2.2 Device Monitor

By registering device addresses in Run Mode, both data monitoring and changing can be conducted. Registered device addresses are listed in Device Monitor in ascending order (A to Z, 0 to 9). Registered device addresses are saved until power to the Touch is turned OFF, or the mode is changed.



- Available device address range depends on types and settings of external devices. Selecting unavailable device address, "Communication error" happens and it can not be back in without reboot. For details, refer to Chapter 30 "1.1 Errors Displayed on the Screen" on page 30-1.
- If three Popup Screens are displayed on the screen (or if two Popup Screens are displayed in the Alarm Log Settings), in order to use Device Monitor in the same way on Popup Screens, the Device Monitor cannot be used.

● Displaying Device Monitor

- 1 Press the upper-left corner of the screen on the Touch for three seconds or more.
The Maintenance Screen is displayed.

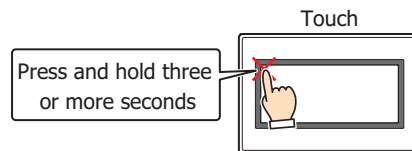

- 2 Press **Device Monitor**.

Device Monitor is displayed.

Maintenance		×
System Mode	Device Monitor	
Brightness/ Contrast	Ladder Monitor	
Ladder Start/Stop		



If a password has been configured for the project data, the Enter Password screen will be displayed. Select a user name and then enter a password. For details, refer to Chapter 21 "User Accounts and the Security Function" on page 21-1.

● Device Address Registration

1 Press **Select** on Device Monitor.

The Select Device screen is displayed.

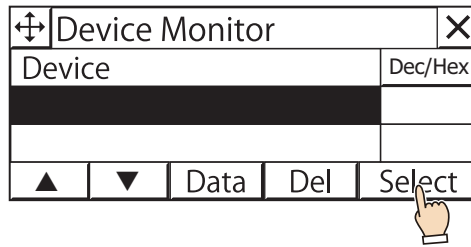

2 Press **Up** or **Down** to select the device type.

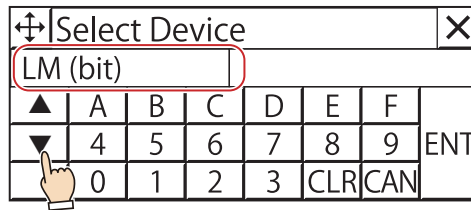

The next address of the device address entered previously is automatically displayed in the Select Device screen.

3 Enter the address and then press **ENT**.

- Press **CLR** to clear all values entered for the address.
- Press **CAN** to stop registering devices.

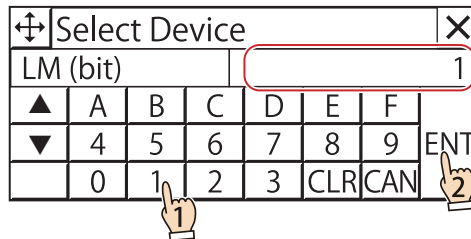

- If a device address is invalid, pressing **ENT** will not return to Device Monitor.
- For 1:N communication, : is displayed. Enter the station number as a 2-digit hexadecimal value. Press :, specify the station number and then enter the address.
- Control device addresses are displayed on Device Monitor with a # before the device type.

Example: When setting D100
 Device Monitor: #D100
 Ladder Monitor: D100

The device address is registered to Device Monitor.

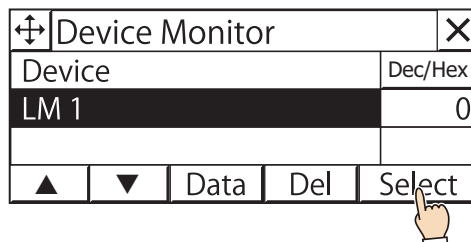

4 Repeat steps 1 through 3 to register all device addresses to be monitored.

● Changing Value of Device

- 1 Press **Up** or **Down** to select the device to be changed the value.

Device Monitor		×
Device	Dec/Hex	
LM 1	0	
LM 2	0	
▲	▼	Data Del Select

- 2 Press **Data** on Device Monitor.
The Write Data screen is displayed.

Device Monitor		×
Device	Dec/Hex	
LM 1	0	
LM 2	0	
▲	▼	Data Del Select

- 3 Press **Dec/Hex** to switch the display type for values of devices.
Switches between **DEC** and **HEX**.

Write Data		×				
LM 2	0	ENT				
Dec/Hex	A	B	C	D	E	F
Current	5	6	7	8	9	CAN
/ OH	0	1	2	3	4	CLR

- 4 Enter the value of device and press **ENT**.
 - Press **CLR** to delete the entered value of device.
 - Press **CAN** to stop entering the value of device.

Write Data		×				
LM 2	1	ENT				
Dec/Hex	A	B	C	D	E	F
Current	5	6	7	8	9	CAN
/ OH	0	1	2	3	4	CLR



- If a value of device is invalid, pressing **ENT** will not return you to Device Monitor.
- If the display type is decimal, **A** to **F** cannot be used.



The value of device is changed.

Device Monitor		×
Device	Dec/Hex	
LM 1	0	
LM 2	1	
▲	▼	Data Del Select

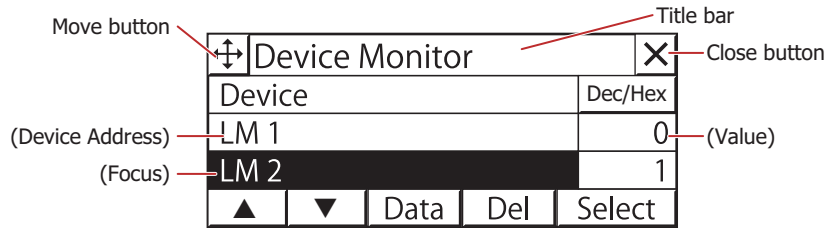
● Device Monitor Configuration



■ Title Bar

Displays the title,  (Move) button, and  (Close) button.

 (Move) button: Moves the Device Monitor.

 (Close) button: Closes the Device Monitor.

■ Dec/Hex

Switches the display type for the current value of device. Switches between **DEC** and **HEX**.

■ (Device Address)

The registered device address is displayed.

■ (Value)

The current value of device is displayed.

■ (Focus)

Highlights the selected device address.

■ ▲

Moves the focus up by one line.

■ ▼

Moves the focus down by one line.

■ Data

Changes the value of the selected device address. Press to display the Write Data Screen. For details, refer to "Changing Value of Device" on page 24-21.

■ Del

Deletes the selected device address.

■ Select

Registers a selected device address. Press to display the Select Device Screen. For details, refer to "Device Address Registration" on page 24-20.

2.3 Ladder Monitor

This function displays the ladder program along with execution states. This enables you to visually understand the states of the ladder program. The Ladder Monitor can only be used when ladder program is selected as the programming language for control function. For details, refer to Chapter 2 "Ladder Program Monitoring on the SmartAXIS" in the "SmartAXIS Ladder Programming Manual".

● Displaying Ladder Monitor

Use the Goto Screen Button, the Goto Screen Command, or the follow method to display the Ladder Monitor.

- 1 Press the upper-left corner of the screen on the Touch for 3 seconds or more.
The Maintenance Screen is displayed.

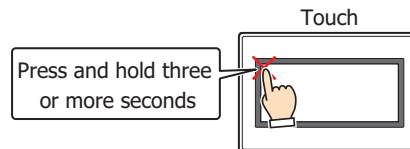

- 2 Press **Ladder Monitor**.
The select line screen is displayed.

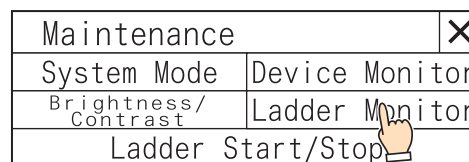

If a password has been configured for the project data, the Enter Password screen will be displayed. Select a user name and then enter a password. For details, refer to Chapter 21 "User Accounts and the Security Function" on page 21-1.

- 3 Press **Last Monitored Line** or **Go To ...**.
Select **Last Monitored Line** to display the Ladder Monitor and start the monitor from the last monitored line.
Select **Go To ...** to display the Go To screen. Enter the desired line and press **OK** to display the Ladder Monitor and start the monitor from the specified line.



When the following operations are performed, **Last Monitored Line** is reset to the first line of the ladder program.

- The power is turned on.
- The project is downloaded.

● Moving the focus

- 1 The Ladder Monitor is displayed.
Use the Goto Screen Button, the Goto Screen Command, or the Maintenance Screen to display the Ladder Monitor.
- 2 Press **←**, **↑**, **↓**, and **→** to move the focus to the desired position.
Press and hold to repeatedly move the focus.

● Displaying instruction parameters

- 1 The Ladder Monitor is displayed.
Use the Goto Screen Button, the Goto Screen Command, or the Maintenance Screen to display the Ladder Monitor.
- 2 Press **←**, **↑**, **↓**, and **→** to move the focus to the desired instruction.
- 3 Press **OK**.
The detailed information screen is displayed.
- 4 Press **ESC**.
Closes the detailed information screen.

● Ladder Monitor Configuration

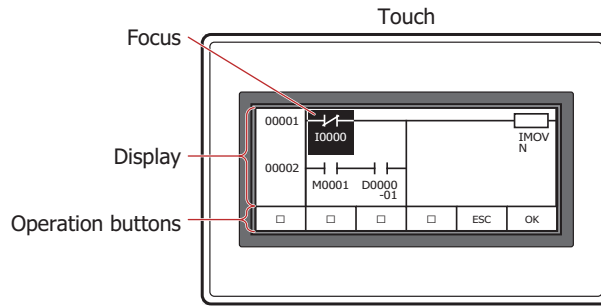

■ Display

This area displays the ladder program and the parameters for the instructions.

Ladder program: Displays the ladder program used by the running project.

Up to five symbols can be displayed per line.

Example:

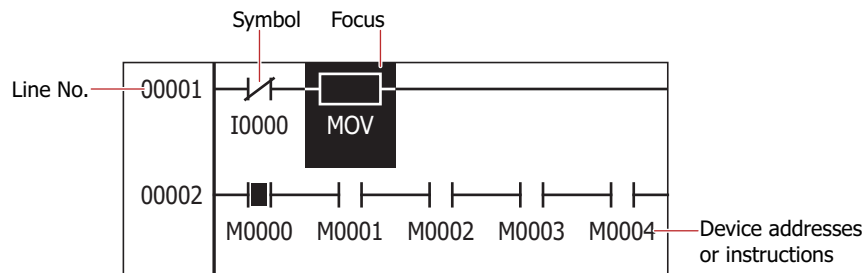

Line No.: Shows the ladder program line number.

Symbol: Shows the instruction symbol.

Focus: Displays the selected instruction with the colors reversed.

Device addresses or instructions:

The LOD, LODN, OUT, OUTN, SET, RST, AND, ANDN, OR, and ORN instructions display the device address under the symbol. The displayed device addresses are as follows.

"Device type (one character)" + "Address (four characters)" (+ "Bit position (two characters)")

For details, refer to Chapter 27 "1.2 Control Device Addresses" on page 27-4 and Chapter 27 "2.2 Control Device Addresses" on page 27-12.

MCS, MCR, JMP, END, LABEL, LJMP, LCAL, and LRET instructions are displayed in one line on the screen.

The instructions other than those listed above display the instruction name under up to a maximum of five characters.



Details of the following instructions can be displayed in the details screen:

Basic instructions: LOD, LODN, OUT, OUTN, SET, RST, AND, ANDN, OR, ORN, TML, TIM, TMH, TMS, TMLO, TIMO, TMHO, TMSO, CNT, CDP, CUD, CNTD, CDPD, CUDD, SFR, SFRN, CC=, CC>=, DC=, DC>=

Move instructions: MOV, MOVN, IMOV, IMOVN, IBMV, IBMVN

Binary arithmetic instructions:

ADD, SUB, MUL, DIV, INC, DEC, ROOT, SUM

Details: Displays detailed information for the selected instruction. Select an instruction on the ladder program and press **OK** to display. The displayed content varies based on the instruction.

Example:

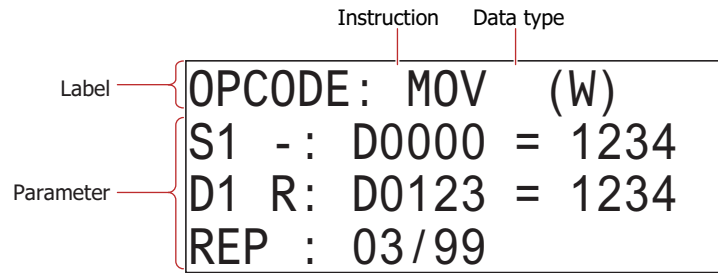

Label: Shows the name and data type of the instruction.

Instruction: Shows the instruction name up to a maximum of 5 characters.

Data type: Shows the data type. The displayed data types are as follows.
W (word), I (integer), D (double word), L (long), F (float)

Parameter: Shows the configuration details for the instruction.

■ Operation button

→: Moves the focus right by one line.

←: Moves the focus left by one line.

↑: Moves the focus up by one line.

↓: Moves the focus down by one line.

OK: Toggles the contact state for the selected NO contact or NC contact.
Press and hold to display the detailed information for the instruction with focus.

ESC: The operation varies based on the content displayed in the display.

Ladder program: Closes the Ladder Monitor.

Details: Closes the detailed information screen.

Chapter 25 Data Transfer Function

This chapter describes the Project Transfer function to upload and download project data to the Touch using external memory.

The function to exchange data using external memory is generically referred to as the Data Transfer function.

1 Project Transfer Function

1.1 How the Project Transfer Function is Used

The project transfer function uploads or downloads project data between the Touch and an external memory inserted in the Touch.

- Download project data saved on an external memory to the Touch. However, you must create project data for transfer.

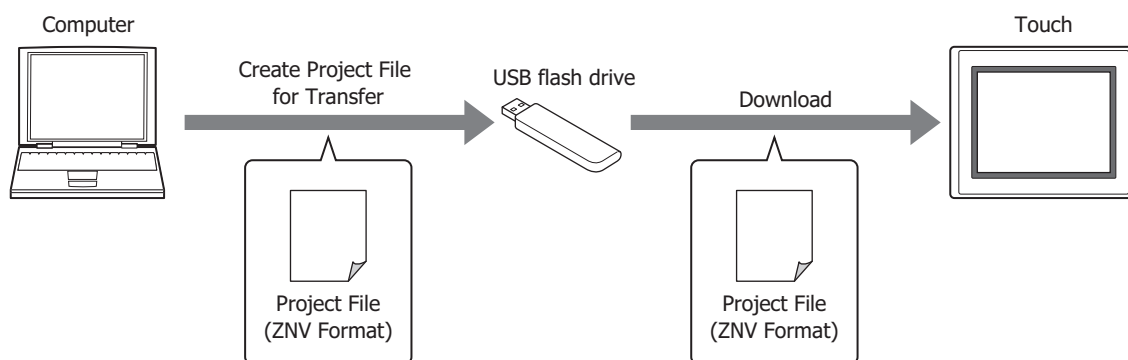

- Upload the project data used for operation on the Touch and save it to an external memory.

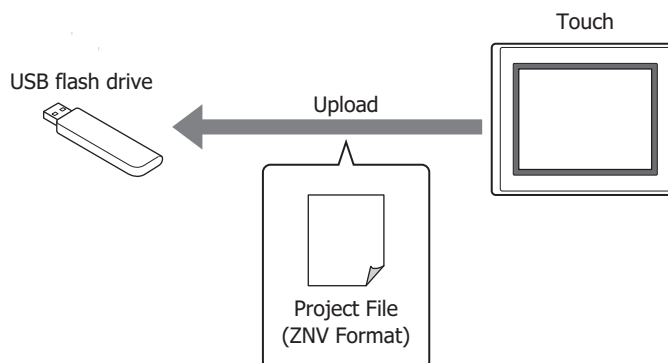

When using the project transfer function and a project file is uploaded, the project file name is "project name + file extension (.ZNV)".

1.2 Project Data Transfer Procedures

The following methods can be used to upload or download project data between the Touch and an external memory inserted in the Touch.

- Using the USB Autorun function
☞ For details, refer to Chapter 26 "2 USB Autorun Function" on page 26-18.
- Using Key Buttons, Multi-Buttons, or Multi-commands
☞ For details, refer to "1.4 Using Key Buttons, Multi-Buttons, or Multi-Commands to Transfer Project Data" on page 25-5.

1.3 Converting Project Data for Transfer

Project data must be converted to dedicated data for transfer in order to download project data to the Touch using the project transfer function.

Use the following procedure to create project data for transfer using an external memory.

- 1 Insert a USB flash drive in the computer's USB port.



- 2 Open the project data to transfer using WindO/I-NV3.
- 3 On the **Home** tab, in the **Project** group, click the **Download** icon.

The Download dialog box is displayed.

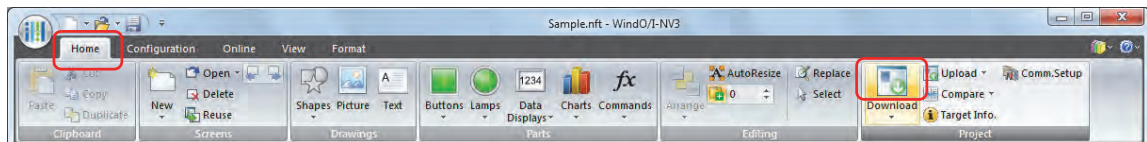

When the project data has not been saved after it was opened, a save confirmation message is displayed. Click **OK** to save the project data and display the Download dialog box. Click **Cancel** to return to the editing screen without saving the project data.

- 4 Check that **Communication Settings** is **External Memory**, and then click **Download**.

The Select Drive dialog box is displayed.

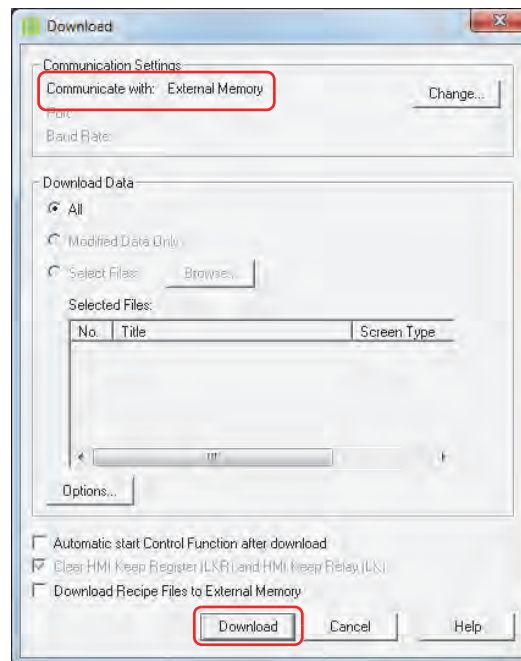

1. If **Communication Settings** is not **External Memory**, click **Change**. The Communication Settings dialog box is displayed.
2. Select **External Memory** for **Communicate with**, and then click **OK**.

- 5 Specify the drive for the USB flash drive, and then click **OK**.

A continue download confirmation message is displayed.

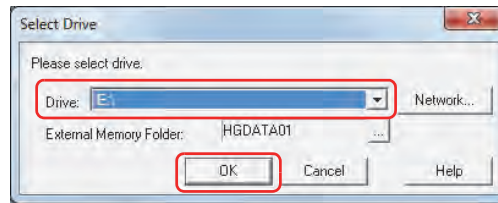

■ **Drive**

Specify the drive assigned to the external memory.

■ **Network**

Displays the Network Drive Assignment dialog box. You can specify a drive on the network.

■ **External Memory Folder**

Specify the folder where the project data is to be downloaded.

Click to display the Project Settings dialog box. You can specify an External Memory Folder as the download destination.

- 6 Click **Yes**.

The Download dialog box is displayed and the project data is now being saved.

When this process is complete, a message is displayed.

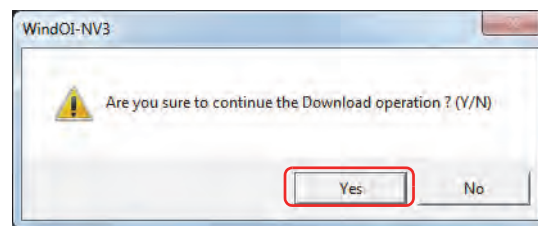

- 7 Click **OK**.

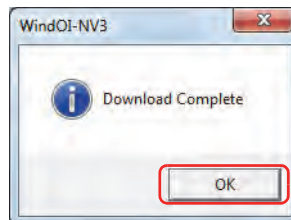

- 8 Click **Close** on the Download Project dialog box.

The project data for transfer is created in the External Memory Folder on an external memory.

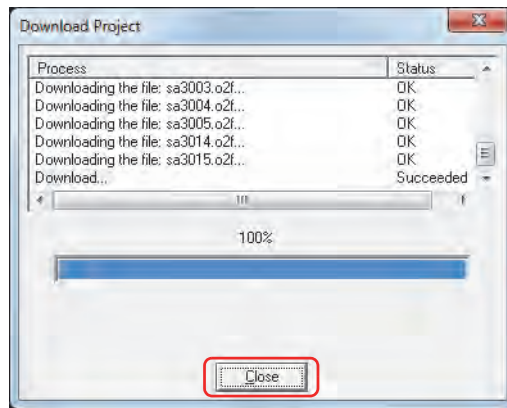

For details about the created data folder and file structure, refer to Chapter 26 "External Memory Devices" on page 26-1.



If the folder or file structure on the External Memory Folder is modified, the Touch and WindO/I-NV3 will not be usable.

1.4 Using Key Buttons, Multi-Buttons, or Multi-Commands to Transfer Project Data



Allocate a Key Button, Multi-Button, or Multi-Command configured with the project transfer function to the Touch.

- ☞ For details, refer to Chapter 7 “4 Key Button” on page 7-49.
- ☞ For details, refer to Chapter 7 “5 Multi-Button” on page 7-68.
- ☞ For details, refer to Chapter 11 “5 Multi-Command” on page 11-31.

● Download

- 1 Create a project file for transfer (.ZNV) and save it on a USB flash drive.
For details, refer to “1.3 Converting Project Data for Transfer” on page 25-2.
- 2 Insert a USB flash drive in the Touch.

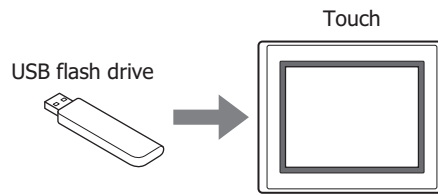

- 3 Press the Key Button or Multi-Button or execute the Multi-Command configured with **Download Project** under **Data Transfer** on the Key Browser.

● Upload

- 1 Insert a USB flash drive in the Touch.

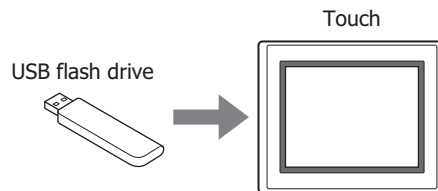

- 2 Press the Key Button or Multi-Button or execute the Multi-Command configured with **Upload Project** under **Data Transfer** on the Key Browser.

1.5 Precautions

- An error message is displayed if the project data upload or download fails. For details, refer to Chapter 30 "1 Error Messages" on page 30-1.
- While the project transfer function is running, the Touch stops processing other functions.
- When project data is downloaded using the project transfer function, the HMI Keep Registers and the HMI Keep Relays are cleared. Control device addresses kept by **Memory Backup** in **Function Settings** are not cleared.
- If a project file (ZNV format) exists with the same name in the save destination when uploading a project file (ZNV format), the file is overwritten with the uploaded file without displaying an overwrite confirmation message.
- When using the project transfer function, make the project data file name half-width alphanumeric characters.
- While running the project transfer function using a Key Button, Multi-Button, or Multi-Command, if a data transfer function (project transfer) is initiated, the only function that will work is the currently running function. If two or more data transfer functions are configured to a Multi-Button or Multi-Command, only the data transfer function displayed at the top of the function list on the parts property dialog box will run.
- When running the project transfer function, the external memory device must have enough free space equivalent to the size of the ZNV project file. Check that there is sufficient free space on the external memory device that will be used with the project transfer function. If the device does not have sufficient free space, the project upload or download may fail.

Chapter 26 External Memory Devices

This chapter describes the specifications, functions, and notes to observe when using external memory devices with the Touch.

1 USB Flash Drives

1.1 How the USB Flash Drive Function is Used

The following functions are available when a USB flash drive is inserted in the Touch.

- USB Autorun function
☞ Refer to "2.1 Overview of the USB Autorun Function" on page 26-18.
- USB Popup Screen function
☞ Refer to "1.8 USB Popup Screen Function" on page 26-15.
- Transferring projects
☞ Refer to "Chapter 25 Data Transfer Function" on page 25-1.
- Alarm Log output
☞ Refer to Chapter 13 "External Memory Tab" on page 13-20.
- Data Log output
☞ Refer to Chapter 14 "External Memory Tab" on page 14-16.
- Operation Log output
☞ Refer to Chapter 15 "External Memory Tab" on page 15-14.
- Reading/writing recipe data
☞ Refer to Chapter 18 "Recipe Function" on page 18-1.

1.2 Specifications

The specifications of supported USB flash drives are as follows.

- Max capacity 32 GB.
- Compatible with FAT16 or FAT32 formatted USB flash drives.
- The maximum file size that can be read and written is 256 MB.
- Character set support only for alphanumeric characters.
- File names may be up to 120 characters long. (Includes file extensions.)
- File paths may be up to 250 characters long. (Includes file extensions and drive characters.)
- Drive letters cannot contain the following characters:
\\ " & () * + , . / : ; < > [] = | ^
- File and directory names cannot contain the following characters:
\\ / : * ? " < > |



Check the IDEC web site for more information about compatible USB flash drives.

1.3 File Structure

When downloading or uploading data using the WindO/I-NV3, the following files and folders are accessible.

By default, the External Memory Folder on the external memory is named "HGDATA01". For details, refer to "1.5 Setting the External Memory Folder" on page 26-12.

USB flash drive

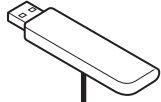

HGDATA01 (External Memory Folder)

Folder name	File name	Description
ALARMLOG	[user-defined].CSV Default file name Batch: ALMHTO.CSV Real time: ALMHTA.CSV	Alarm Log data
DATALOG	[user-defined].CSV Default file name Batch: LOGO**.CSV Real time: LOGA**.CSV	Data Log data (** corresponds to the data number)
OPERATIONLOG	[user-defined].CSV Default file name Batch: OPLOGO.CSV Real time: OPLOGA.CSV	Operation Log data
RECIPE	[user-defined].CSV Default: RCP***.CSV	Recipe data (*** corresponds to the recipe number)
NVDATA	[Project name].ZNV	Project files



HGDATA02



HGDATA03



Users can create multiple external memory folders for different projects on a single USB flash drive. Note, the External Memory Folder on the external memory must reside on the root directory.



Do not alter project files (ZNV format). Altered files cannot be used with Touch.

1.4 Reading/Writing Data

● Using WindO/I-NV3 to read and write to an external memory inserted in the Touch

This procedure shows how to read and write data to the External Memory Folder specified for the project currently running on the Touch.

Use either method below to make the connection.

- Connect a USB cable to the USB port on the computer and the USB interface on the Touch.
- Connect an Ethernet cable to the Ethernet port on the computer and the Ethernet interface on the Touch.

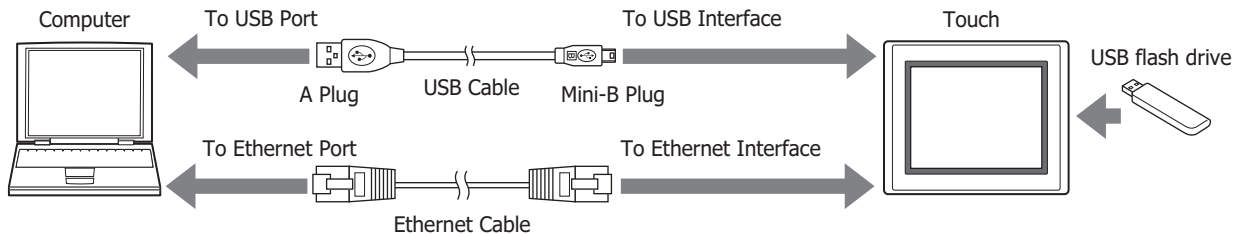

Communication settings

Follow these procedures to configure the communication device and port to allow reading and writing to the USB flash drive inserted in the Touch.

1 On the **Home** tab, in the **Project** group, click **Comm. Setup**.

The Communication Settings dialog box appears.

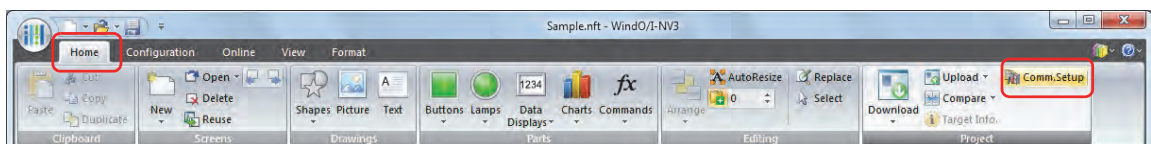

2 Select **Touch** under **Communicate with**.

3 Select the type of connection under **Port**, and then click **OK**.

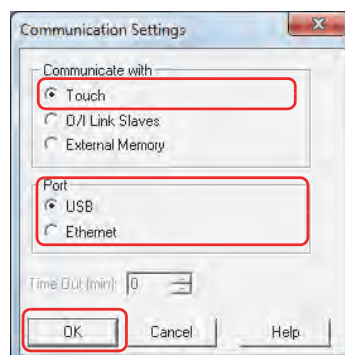

Downloading

This procedure shows how to download a specified file into the External Memory Folder on the external memory for the currently running project.

- 1 On the **Home** tab, in the **Project** group, click the arrow under **Download**.
- 2 Click **Files to External Memory** or **Files to External Memory while running**.

The Open dialog box appears.

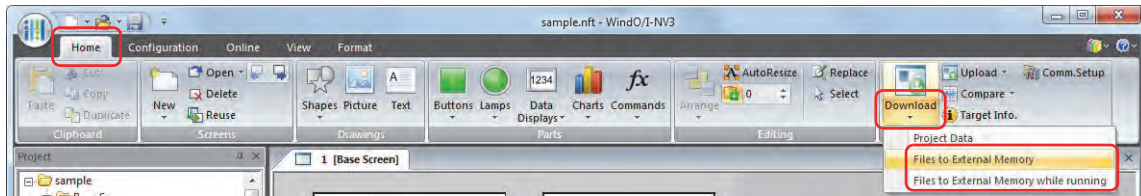

Files to External Memory

This function temporarily stops the Touch and then downloads files to the USB flash drive inserted in the Touch. Touch resumes running when files have been downloaded.

Files to External Memory while running

This function downloads files to the USB flash drive inserted in the Touch without stopping the Touch.

- 3 Specify the file name, and then click **Open**.

A confirmation message appears.

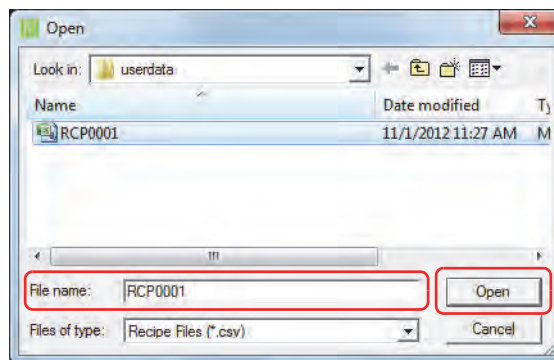

If security is enabled in the Touch project, the Password Screen is displayed. Select the user name and enter the password.

For details, refer to Chapter 21 "User Accounts and the Security Function" on page 21-1.

- 4 Click **Yes**.

The External Memory Maintenance dialog box appears and the file download begins.

When the download is complete, a message box appears.

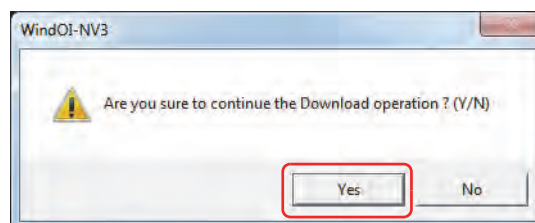

- 5 Click **OK**.

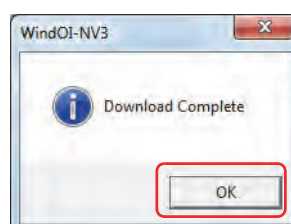

- 6 Click **Close** on the External Memory Maintenance dialog box.

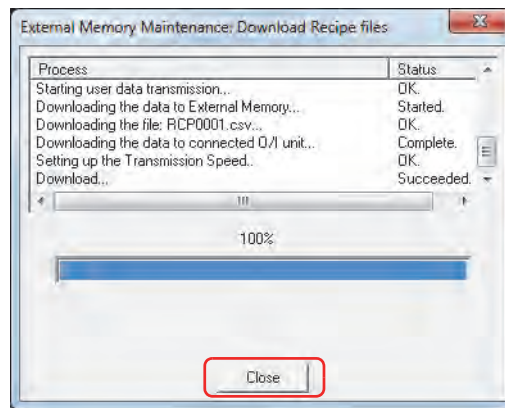

Uploading

This procedure shows how to upload specified data from the External Memory Folder on the external memory for the currently running project.

- 1 On the **Home** tab, in the **Project** group, click the arrow next to **Upload**.
- 2 Click **Stored Data in External Memory**.

The Upload from External Memory dialog box appears.

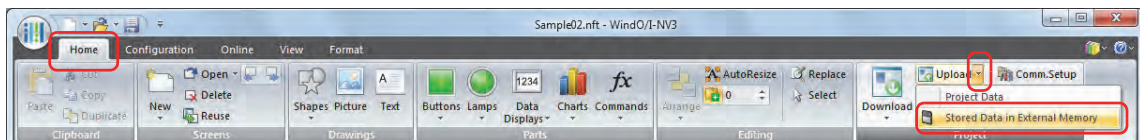

- 3 Specify the type of data to upload by checking the appropriate items.
- 4 Specify the destination folder in the **Path** box.
- 5 Click **OK**.

The External Memory Maintenance dialog box appears and the data upload begins. A message box appears when the data upload is complete.

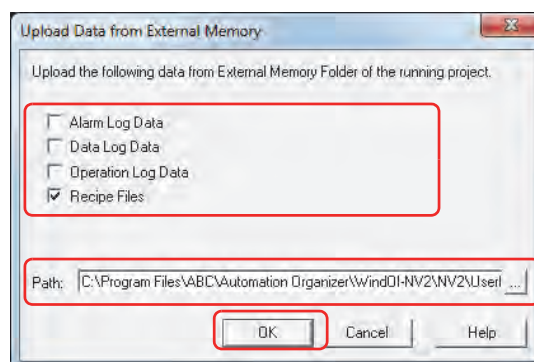

The following kinds of data can be uploaded.

- Alarm Log Data
- Data Log Data
- Operation Log Data
- Recipe Files



- Click  to display the Select a Folder dialog box and specify the destination folder for uploading.
- After starting WindO/I-NV3, Alarm Log data, Data Log data, and Recipe files can be uploaded from an External Memory Folder without opening project data.



If security is enabled in the Touch project, the Password Screen is displayed. Select the user name and enter the password.

For details, refer to Chapter 21 "User Accounts and the Security Function" on page 21-1.

- 6 Click **OK**.



- 7 Click **Close** on the External Memory Maintenance dialog box.

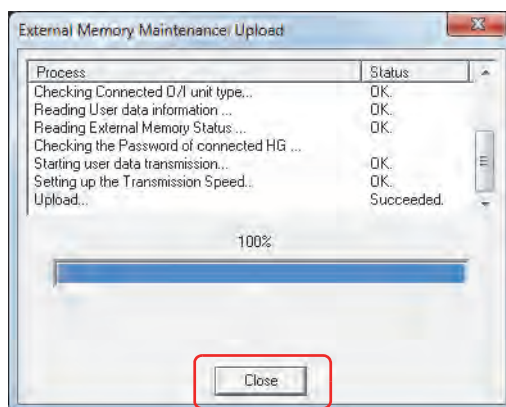

- Using Downloader to read and write to a USB flash drive inserted in the Touch Maintenance is performed on data in the External Memory Folder on the external memory specified for the project currently running on the Touch.

Downloading

This procedure shows how to download a specified file into the External Memory Folder on the external memory for the currently running project.

- 1 In Downloader, under the **External Memory Maintenance**, click **Files to External Memory** or **Files to External Memory while running**.

The Open dialog box appears.

- 2 Specify the file name, and then click **Open**.

This procedure saves the data to the External Memory Folder on the USB flash drive inserted in the Touch.

Uploading

This procedure shows how to upload specified data from the External Memory Folder on the external memory for the currently running project.

- 1 In Downloader, under **External Memory Maintenance**, click **Upload**.

The Upload from External Memory dialog box appears.

- 2 Specify the data to upload and where to save it to, then click **OK**.

This procedure uploads data to the External Memory Folder on the USB flash drive inserted in the Touch and saves it in the user-specified location.

- Using WindO/I-NV3 to read and write to a USB flash drive inserted in the computer
This procedure shows how to read and write from a USB flash drive inserted in the computer's USB port.



Communication settings

To read and write to the USB flash drive inserted in the computer, the **External Memory** must be selected under the **Communicate with**. Configure the communication settings as follows before downloading or uploading.

- 1 On the **Home** tab, in the **Project** group, click **Comm. Setup**.

The Communication Settings dialog box appears.

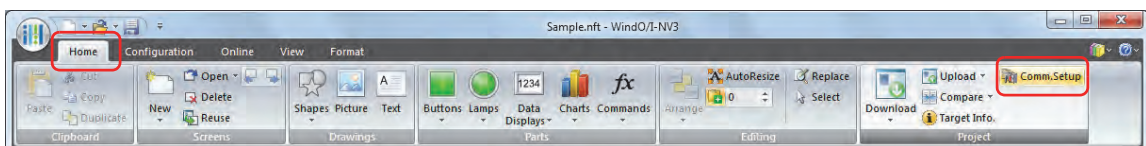

- 2 Under **Communicate with**, select **External Memory**, and then click **OK**.

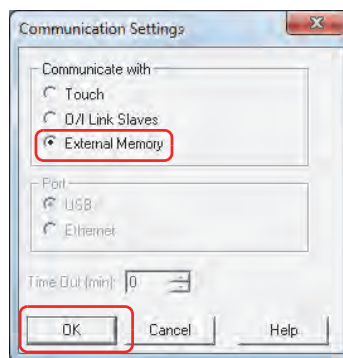

Downloading

This procedure shows how to download the project data to the External Memory Folder on the USB flash drive.

- 1 Open the project data to download using WindO/I-NV3.
- 2 On the **Home** tab, in the **Project** group, click the icon above **Download**.

The Download dialog box appears.

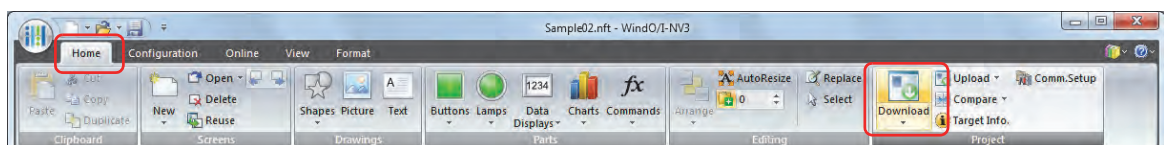

3 Click **Download**.

The Select Drive dialog box appears.

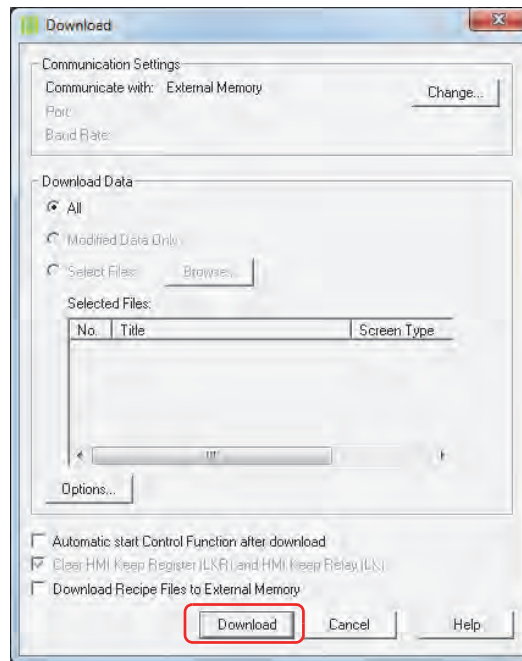

4 Select the external memory drive, and then click **OK**.

A confirmation message appears.

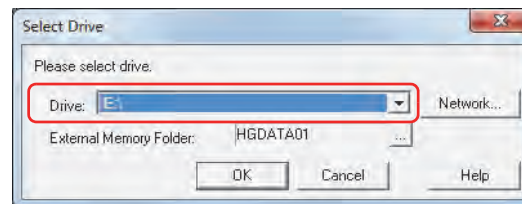

■ **Drive**

Specify the drive assigned as the external memory drive.

■ **Network**

The Network Drive Assignment dialog box appears. This dialog box allows you to specify a drive on the network.

■ **External Memory Folder**

Specify the destination folder for downloading project data.

Click [...] to display the Project Settings dialog box. This procedure allows you to specify the External Memory Folder on the external memory where the download will be stored.

5 Click **Yes**.

The Download dialog box appears and the file download begins.

When the download is complete, a completion message appears.

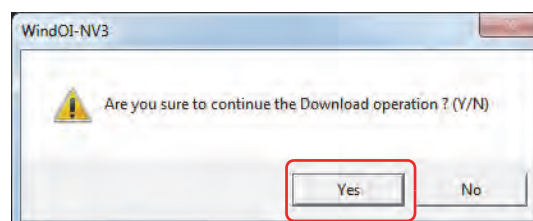

- 6 Click **OK**.

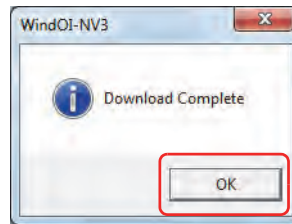

- 7 Click **Close** on the Download dialog box.

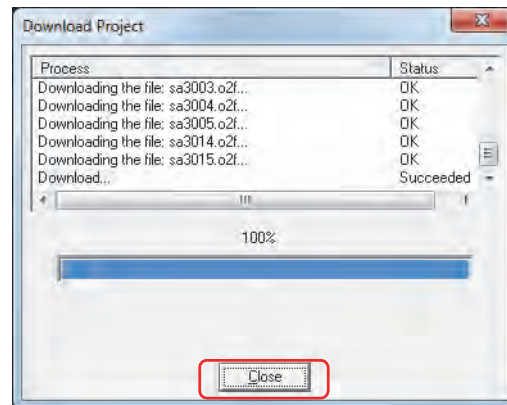

Uploading

This procedure shows how to upload the project data from the External Memory Folder on the USB flash drive inserted in the computer, to the computer.

- 1 On the **Home** tab, in the **Project** group, click **Upload**.

The Select External Memory Folder dialog box appears.

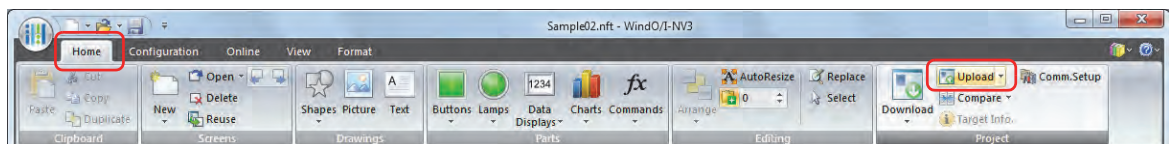

- 2 Select the external memory drive, and then click **OK**.

The Upload dialog box appears.

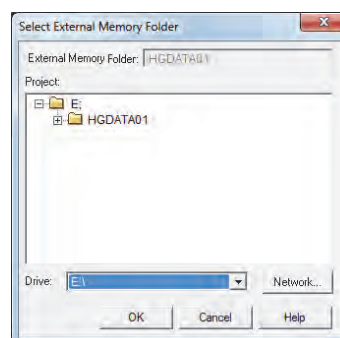

■ External Memory Folder

Displays the folder specified in the **Project** tree described next.

■ Project

Specify the destination folder for uploading the project data.

■ Drive

Specify the drive assigned as the external memory drive.

■ Network

The Network Drive Assignment dialog box appears. This dialog box allows you to specify a drive on the network.

3 Click **Upload**.

The Upload dialog box appears and the file upload begins.

When the upload is complete, a completion message appears.

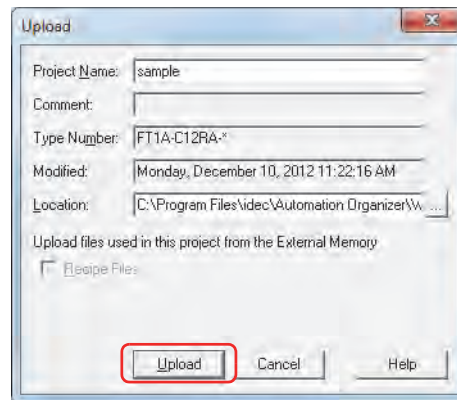
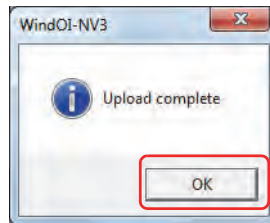
**4** Click **OK**.**5** Click **Close** on the Upload dialog box.

A confirmation message appears indicating the project will be opened.

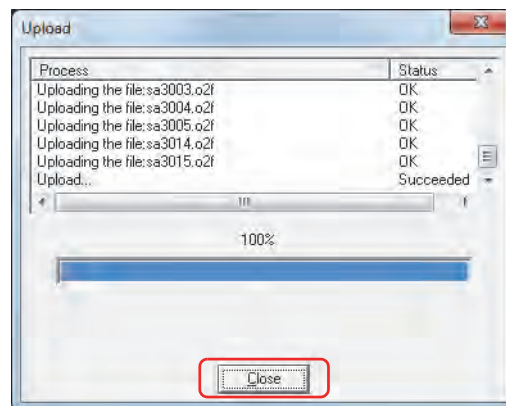
**6** Click **OK**.

The uploaded project opens.

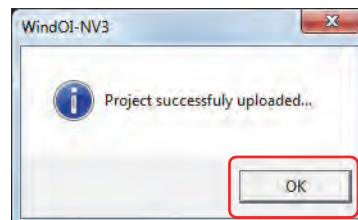

- Manipulating files using the file management functions provided with the OS

It is possible to use Explorer or any other program provided with the Windows OS to replace the recipe data that Touch uses.

Insert the USB flash drive into the computer and save the new file(s) using the same name as the existing files in each folder under the External Memory Folder.

- External memory writing timing

If the write timing setting for Alarm Log, Data Log, and Operation Log data is set to **Real Time** to USB flash drive, the data is stored in the file output buffer once.

The writing timing from the file output buffer to the USB flash drive is as follows.

- Within three minutes of an output event to the USB flash drive.
- When the HMI Special Internal Relay LSM18 changes to 1.
- When switching to the Top Page in the System Mode.
- When downloading/uploading project data.
- When the Access Pause button is pressed.



In the following events, WindO/I-NV3 writes the data in the file output buffer to the USB flash drive once, and then moves on to the next process. This creates a processing delay which can cause WindO/I-NV3 to raise a communication error when downloading or uploading a project file. If a communication error occurs, try downloading or uploading the project file again.

- When data exists in the file output buffer
- When attempting to switch to the Top Page in the System Mode while reading/writing to the USB flash drive.
- When downloading or uploading project data.

1.5 Setting the External Memory Folder

The External Memory Folder on the external memory can be renamed using WindO/I-NV3.

- 1 On the **Configuration** tab, in the **System Setup** group, click **Project**.

The Project Settings dialog box appears.

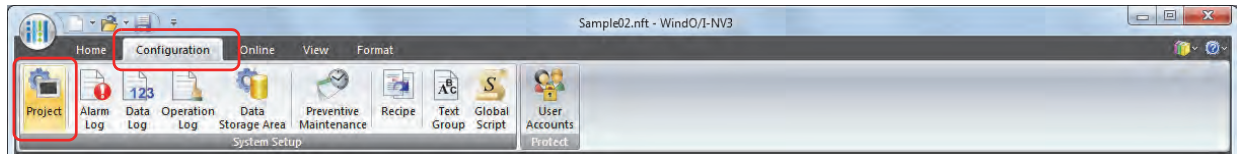

- 2 On the **External Memory** tab, enter the desired name in the **External Memory Folder** text box. Use only alphabetic characters (A to Z) and numbers (0 to 9) and the maximum number is 8 characters.

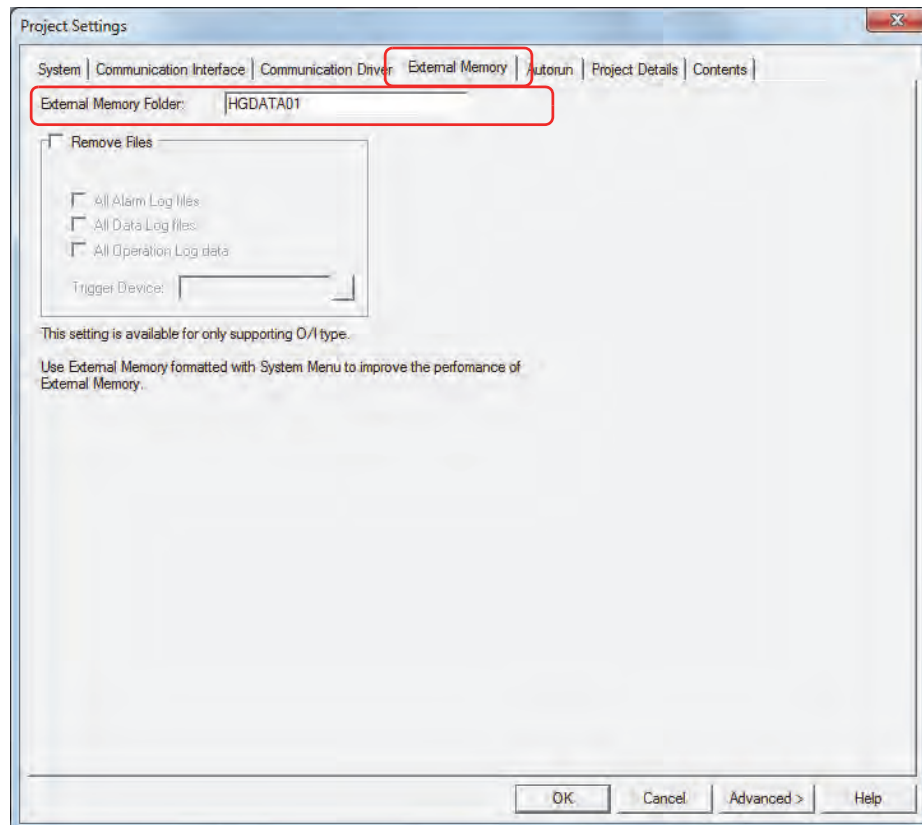

- 3 Click **OK**.



- It is not possible to change folder names and file names other than the External Memory Folder.
- The External Memory Folder is named "HGDATA01" if project data has never been downloaded to the Touch.

1.6 Deleting Files on the USB Flash Drive

When the value of device that uses as a condition for deleting a file changes from 0 to 1, the file is deleted from the External Memory Folder of the USB flash drive inserted in the Touch.

- 1 On the **Configuration** tab, in the **System Setup** group, click **Project**.
The Project Settings dialog box appears.

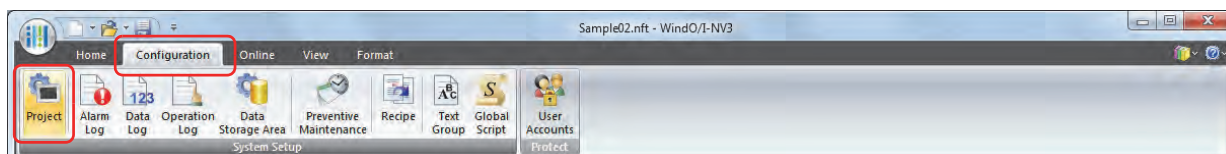

- 2 On the **External Memory** tab, select the **Remove Files** check box.
- 3 Specify the range of files to delete by checking the appropriate items.

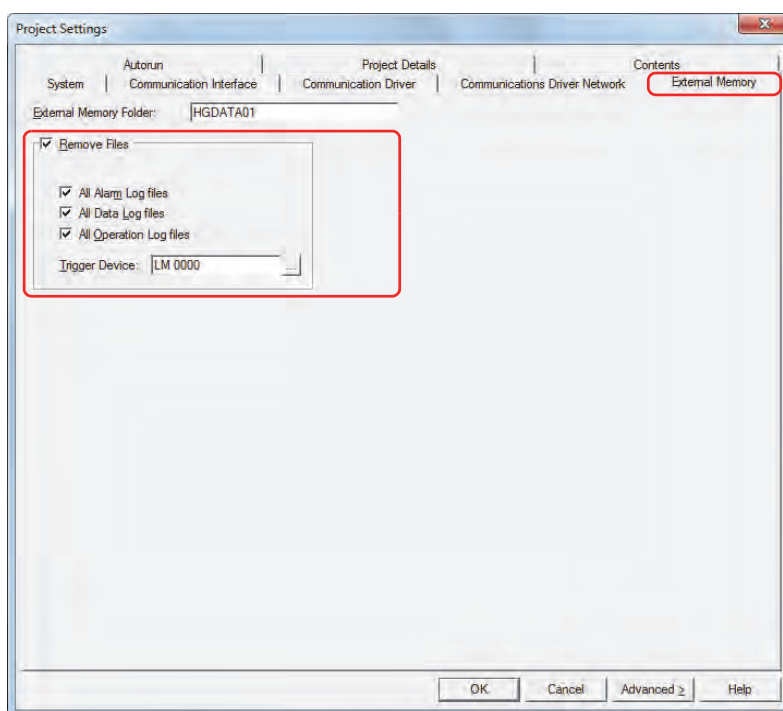

- **All Alarm Log files**
Deletes all files in the ALARMLOG folder.
- **All Data Log files**
Deletes all files in the DATALOG folder.
- **All Operation Log files**
Deletes all files in the OPERATIONLOG folder.
- **Trigger Device**
Specifies the bit device or the bit of a word device to serve as condition for deleting files.

Click  to display the Device Address Settings dialog box. For the device address configuration procedure, refer to Chapter 2 "5.1 Device Address Settings" on page 2-61.

- 4 Click **OK**.



The online function in WindO/I-NV3 can also be used to delete files on the USB flash drive.
For details, refer to Chapter 23 "4 Clear" on page 23-22.

1.7 Formatting the USB Flash Drive



Always format the USB flash drive before using it.

The USB flash drive inserted in the Touch can be formatted with the WindO/I-NV3 online function.

- 1 On the **Online** tab, in the **Touch** group, click **Format**.

A confirmation message appears warning that existing data will be deleted.

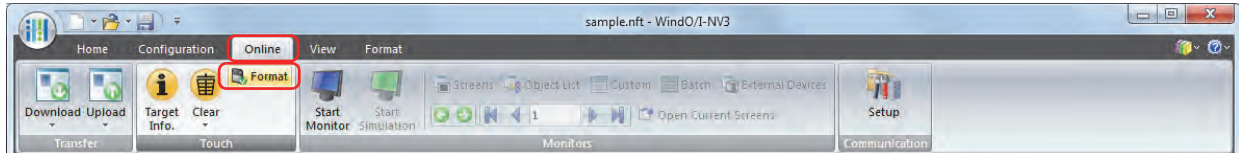

In **Communication Settings, Communicate with** must be set to **Touch** in advance, and **Port** must be set to **USB** in advance. For details on how to configure these settings, refer to “Communication settings” on page 26-3.



If security is enabled for the project saved on the external memory, the Password Screen is displayed. Select the user name and enter the password. For details, refer to Chapter 21 “User Accounts and the Security Function” on page 21-1.

- 2 Click **Yes**.

The External Memory Maintenance dialog box appears and formatting begins.

When the external memory has been formatted, the display returns to the External Memory Maintenance dialog box.

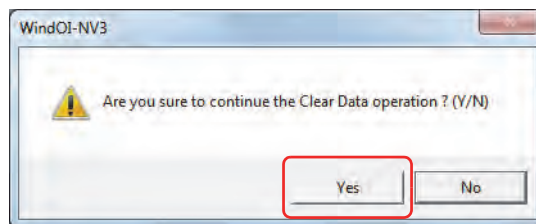

- 3 Click **Close**.

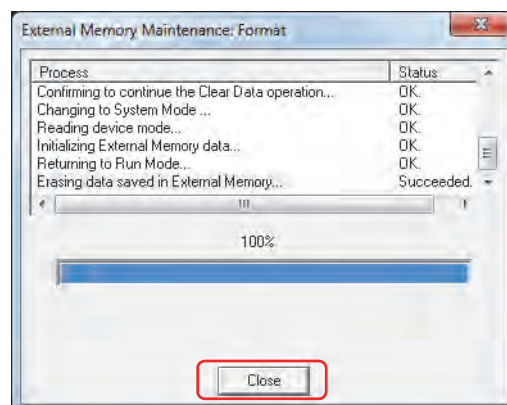

1.8 USB Popup Screen Function

The USB Popup Screen function displays a specific screen by simply inserting a USB flash drive in the Touch. This provides an easy way to display a message when the operator inserts a USB flash drive.

- When a USB flash drive is inserted a popup window is automatically displayed.

Configuration Procedure

- 1 Create the popup window to be displayed when USB flash drive 1 is inserted.

On the **Home** tab, in the **Screens** group, click the arrow under **New** and then click **Popup Screen**.

The Screen Properties dialog box is displayed.

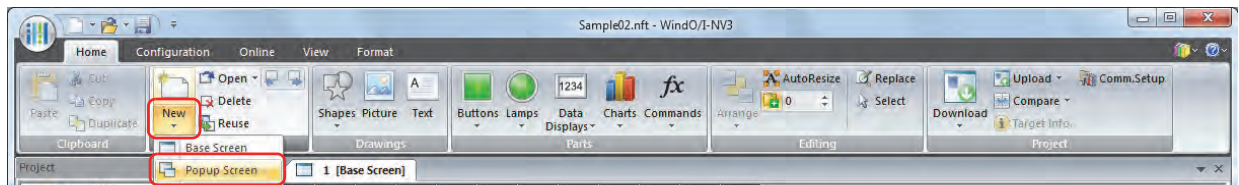

- 2 Change the settings on each tab as necessary, and then click **OK**.
- 3 Arrange the object on the editing screen as required.
- 4 On the **Configuration** tab, in the **System Setup** group, click **Project**.

The Project Settings dialog box appears.

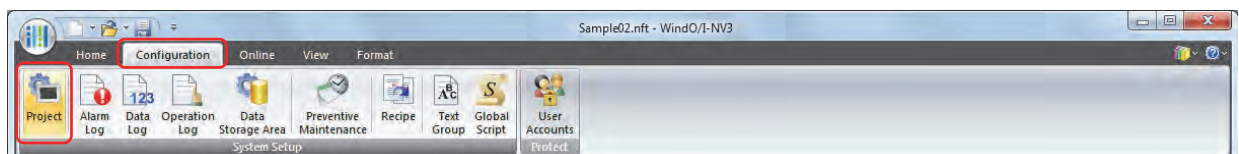

- 5 On the **Autorun** tab, select the **Open Popup Screen when USB Flash Drive is inserted** check box.
- 6 Specify the **Screen No.** of the Popup Screen to display, and the **Coordinates**, then click **OK**.

For details, refer to Chapter 3 "3.9 Autorun Tab" on page 3-41.

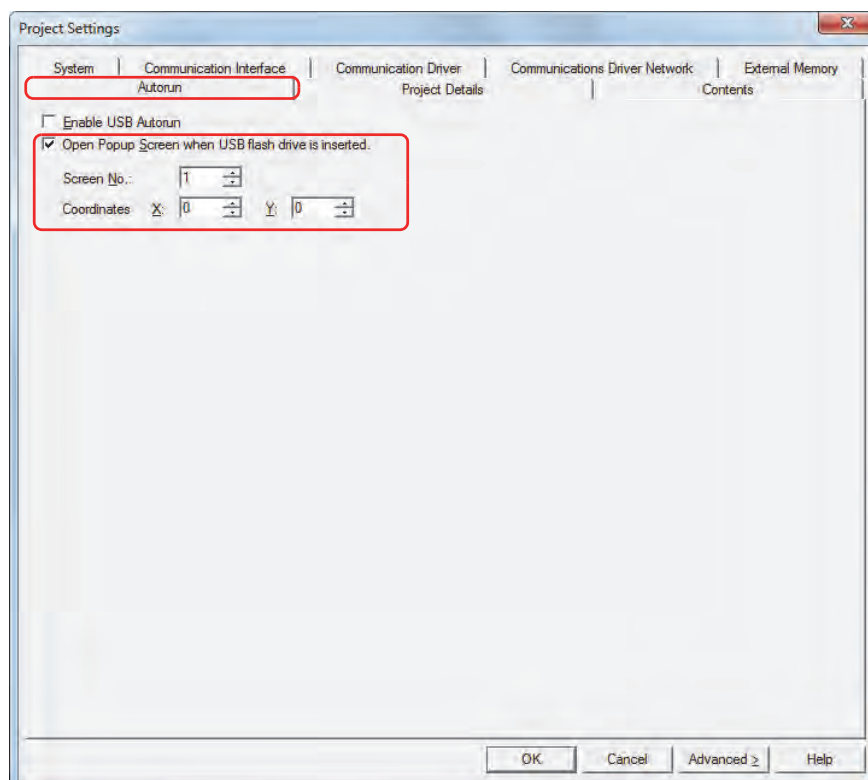

Operating Procedure

Insert the USB flash drive into the Touch.

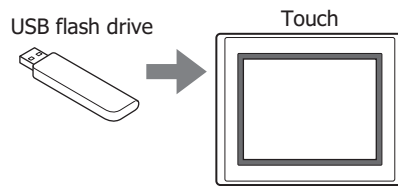

The Popup Screen appears.

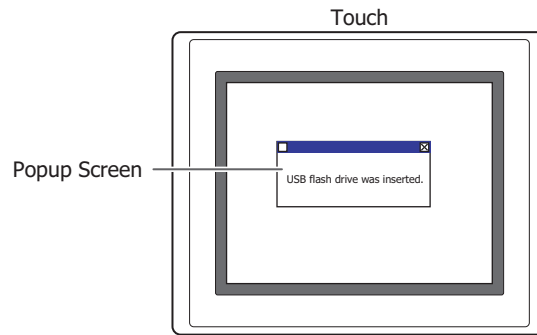

If security is enabled for the Popup Screen that is displayed by the USB Popup Screen function, the Password Screen is displayed. Select the user name and enter the password.
For details, refer to "2.4 USB Autorun Function Security" on page 26-26.



When the USB Popup Screen function is enabled, if the USB flash drive contains a definition file (hgauto.ini) for use with the USB Autorun function, both functions will appear on the menu screen.

1.9 Precautions

- USB flash drives have a limitation on the number of times they can be written to. Regularly backup data on the USB flash drive.
- Never turn the power off or remove the USB flash drive while reading/writing to it. Otherwise, the data on the USB flash drive may be destroyed. Should this occur, reformat the USB flash drive.
- Multiple USB flash drives cannot be used at the same time.
- Before turning off the power to the Touch or before removing the USB flash drive, set HMI Special Internal Relay LSM18 to 1 and check that HMI Special Internal Relay LSM19 is 0.
- The message **Saving USB flash drive** appears while reading or until writing stops. To resume reading/writing to the USB flash drive, re-insert it.
- If an unusable USB flash drive is inserted, the error message **USB flash drive not available** appears.
- Do not alter project files (ZNV format). Altered files cannot be used with Touch.
- Do not connect the USB flash drive to the Touch through a USB hub.

2 USB Autorun Function

2.1 Overview of the USB Autorun Function

The USB Autorun function automatically displays a menu screen from which the user can execute predefined commands when a USB flash drive is inserted into the Touch.

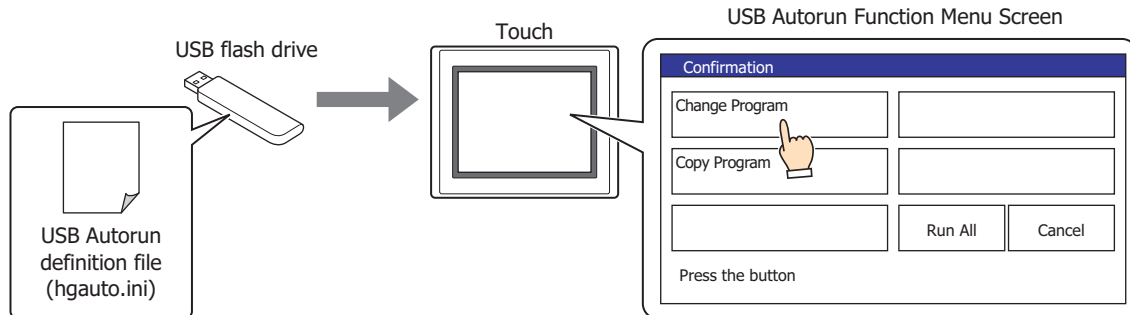

- This allows operators to change project files without using a computer.
- These defined processes are called commands, and the file that contains the details of the command and menu screen is called the USB Autorun definition file (hgauto.ini).
- A USB Autorun definition file (hgauto.ini) must be stored on the USB flash drive to use the USB Autorun function.

The commands that can be executed with the USB Autorun function are as follows.

● Downloading a project file

Downloads a project file (ZNV format) saved on a USB flash drive to the Touch.

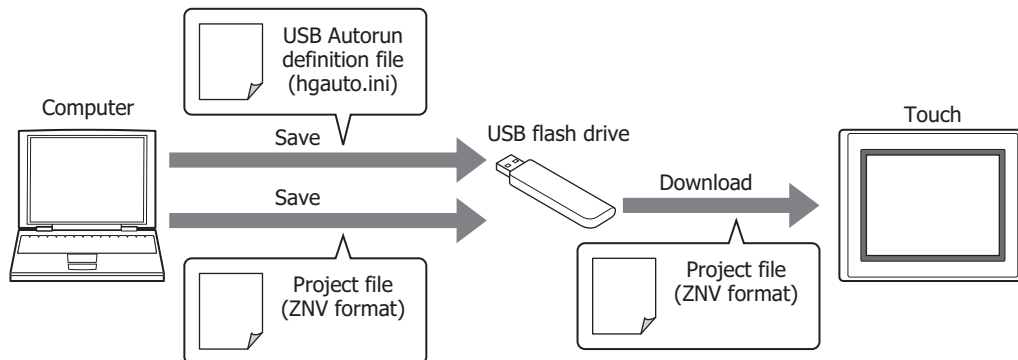

When the download is complete, the Touch will reset and start running from the beginning of the project that was just downloaded.



Refer to Chapter 25 "1 Project Transfer Function" on page 25-1 for important notes and limitations.

● Uploading a project file

Uploads the project file (ZNV format) used to operate the Touch and saves it to a USB flash drive.

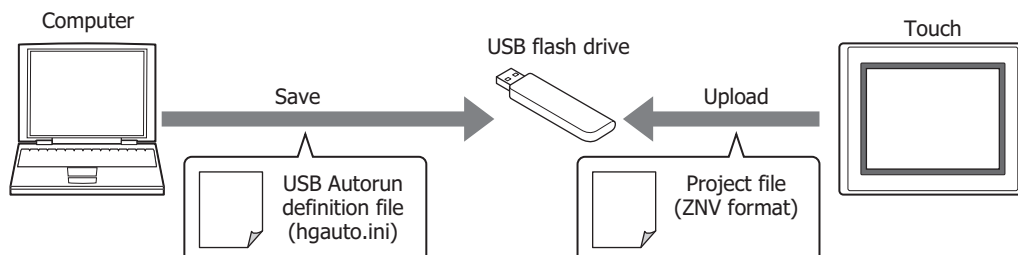

When the upload is complete, the Touch will reset and start over at the beginning of the project.



Refer to Chapter 25 "1 Project Transfer Function" on page 25-1 for important notes and limitations.

2.2 USB Autorun Function Configuration Procedure

- Executing commands using the USB Autorun function

Configuration Procedure

- 1 On the **Configuration** tab, in the **System Setup** group, click **Project**.

The Project Settings dialog box appears.

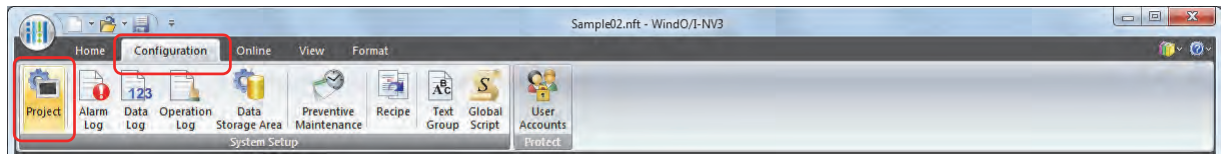

- 2 On the **Autorun** tab, select the **Enable USB Autorun** check box, and then click **OK**.

For details, refer to Chapter 3 "3.9 Autorun Tab" on page 3-41.

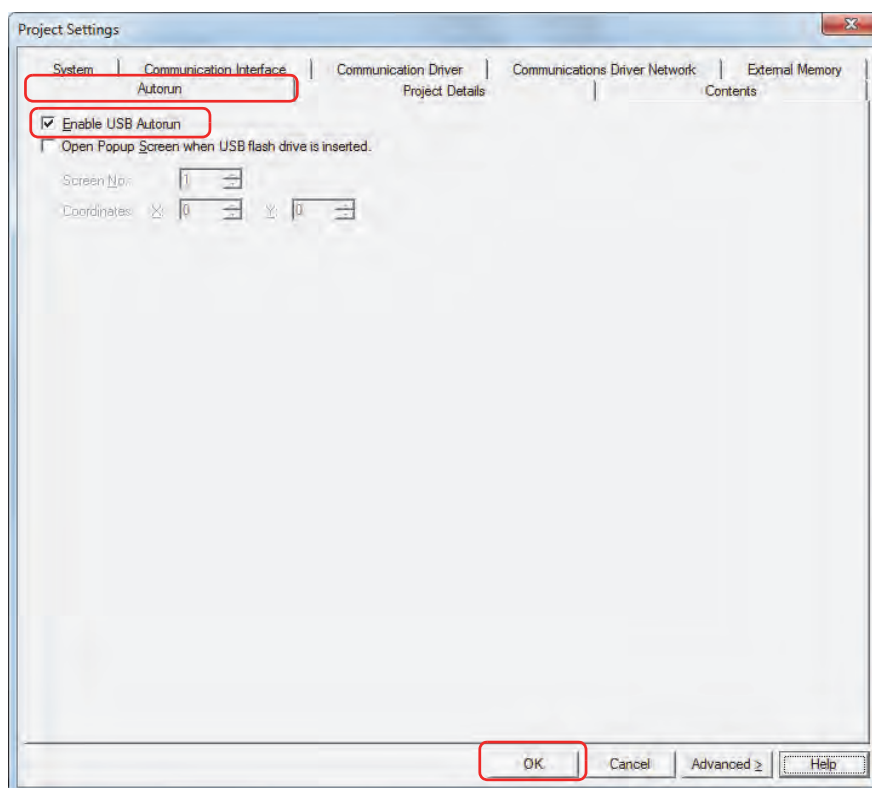

- When enabling the USB Autorun function using the Touch, on the Top Page in the System Mode, press **Main Menu**, **Initial Setting**, **System Op.**, and then press **Autorun**.
- If the USB Autorun function of the Touch is not enabled, the menu screen will not be displayed, even if a USB flash drive is inserted into the Touch.
- Once the USB Autorun function of the Touch is enabled, the function will remain enabled until either a project file with the **Enable USB Autorun** check box unchecked is downloaded, or the function is disabled via the System Mode.

3 Create a USB Autorun definition file (hgauto.ini) and save it on the USB flash drive.

For details, refer to “2.3 Creating a USB Autorun Definition File” on page 26-22.

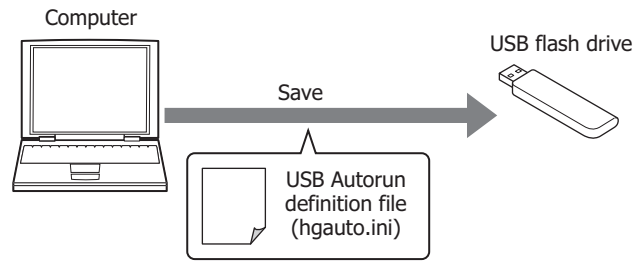

4 Prepare the necessary files and store them on the USB flash drive.

The necessary files are as follows.

- To download a project file
Create a project file (ZNV format).
For details, refer to Chapter 25 “1.3 Converting Project Data for Transfer” on page 25-2.

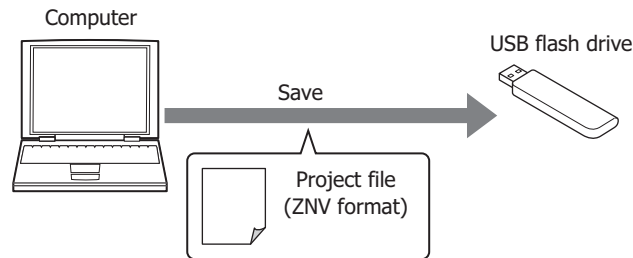

Operating Procedure

1 Insert the USB flash drive into the Touch.

The menu screen for the USB Autorun function appears.

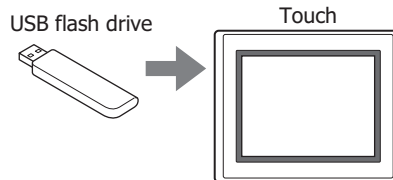

If the menu screen does not appear, follow these troubleshooting tips. Correct the problem and re-insert the USB flash drive.

- | | |
|-----------|--|
| Cause: | USB Autorun definition file (hgauto.ini) does not exist on the USB flash drive. |
| Solution: | Create a USB Autorun definition file and save it on the USB flash drive. For details, refer to “2.3 Creating a USB Autorun Definition File” on page 26-22. |
|
 | |
| Cause: | The USB Autorun definition file (hgauto.ini) contains an error. |
| Solution: | For details, refer to “2.3 Creating a USB Autorun Definition File” on page 26-22. |
|
 | |
| Cause: | The USB Autorun function is disabled in the Touch settings. |
| Solution: | Enable the USB Autorun function by referring to steps 1 and 2 on page 26-19. |

2 Press the command to execute.

The command executes.

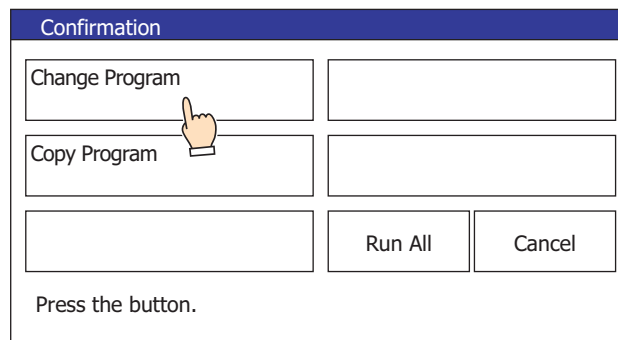

Touching **Run All** causes all commands defined in the USB Autorun definition file (hgauto.ini) to execute one by one.



- If security is enabled in the Touch project, the Password Screen is displayed. Select the user name and enter the password.
For details, refer to "2.4 USB Autorun Function Security" on page 26-26.
- Do not remove the USB flash drive while command is executing.

3 When the command finishes executing, a screen appears indicating the execution result.

Press **Ack** to close the execution result screen and display the menu screen.

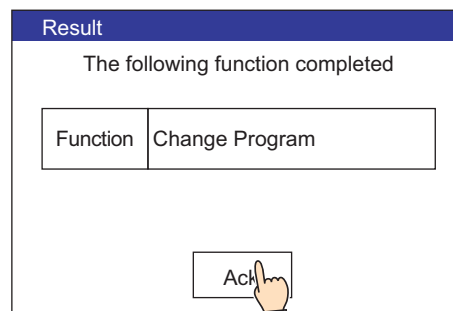

If a command executes with a button (except the **Run All**), the menu screen is displayed after touching **Ack** on the execution result screen.

2.3 Creating a USB Autorun Definition File

The menu screen that appears when a USB flash drive inserted in the Touch is defined in the USB Autorun definition file.

The USB Autorun definition file is created using the following methods.

- Created with the USB Autorun definition file creation tool
 ☞ Refer to USB Autorun Definition File Creation Tool manual.
- Created with the text editor
 ☞ Refer to "Created using the text editor" on page 26-22.

● Created using the text editor

You create this file using Notepad or any commercially available text editor. Fill in the items in each section and save the file with the name "hgauto.ini".

The USB Autorun definition file has these three sections.

Enter the items and definitions for each section.

[AUTORUN] section (required)
 Specify the number of command items, enable/disable the buttons, and the display language to use.

```
[AUTORUN]
item = 2
button_command = Enable
button_runall = Enable
language = English
```

[COMMAND] section (required)
 Specify the command to execute and its parameters. Create buttons to execute the number of commands specified in the [AUTORUN]: section from [COMMAND_1] to [COMMAND_5], in that order.

```
[COMMAND_1]
command = PRO_DOWNLOAD
src_path = "B:\NV3DATA\FT_PROJECT.ZNV"
reset_keep_device = Enable
title = "Change Program"
[COMMAND_2]
command = PRO_UPLOAD
dst_path = "B:\Uploaded_Project"
title = "Copy Program"
```

[COMMENT] section
 Enter text to display, as necessary, at the bottom of the menu screen.

```
[COMMENT]
comment = "Press the button."
```

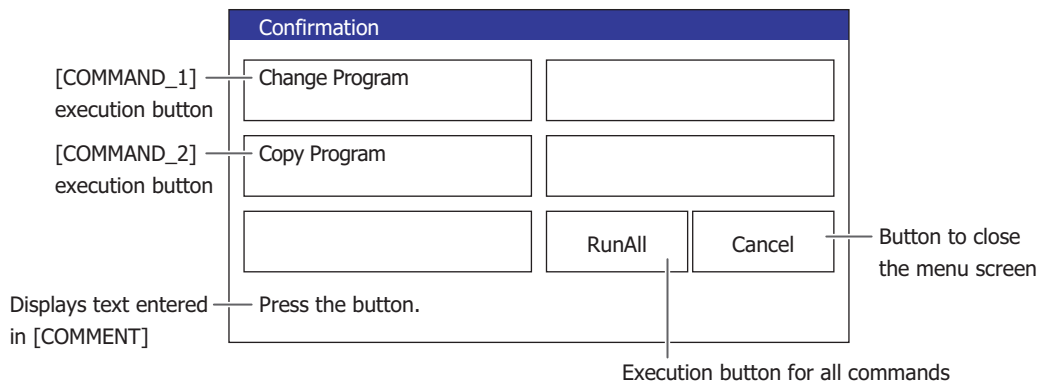

[AUTORUN] section

■ **item (required)**

Specify the number of commands used from 1 to 5. The USB Autorun function will fail to execute if a value other than 1 to 5 is specified.

■ **button_command**

Specify whether to enable or disable the execution buttons for [COMMAND_1] to [COMMAND_5].

Enable: Enables the button.

Disable: Disables the button.



If this item is left blank or contains an illegal value, the Touch assumes "Enable".

■ **button_runall**

Specify whether to enable or disable the execution buttons for **Run All**.

Enable: Enables the button.

Disable: Disables the button.



If this item is left blank or contains an illegal value, the Touch assumes "Enable".

■ **language**

Specify the language to use for the button labels and messages.

Japanese: Shift-JIS

European: English

Chinese: GB2312

Taiwanese: BIG5

Korean

Central European

Baltic

Cyrillic



If this item is left blank or contains an illegal value, the Touch assumes "Japanese".

[COMMAND] section

■ **command (required)**

Specify the command to execute.

PRO_DOWNLOAD: Download a project file.

PRO_UPLOAD: Upload a project file.

The items required differ for each command except for the "title" item.

command = PRO_DOWNLOAD

■ **src_path (required)**

Specify the path (250 or less characters) where the project file is to be downloaded.

Use "B:\\" for a USB flash drive.

■ **reset_keep_device**

Specify whether to initialize the keep devices or not when the project file is downloaded. However, when project data that changes the settings of the data storage area is downloaded, the keep devices are always initialized.

Enable: Initializes the keep device.

Disable: Does not initialize the keep devices.



If this item is left blank or contains an illegal value, the MICRO/I assumes "Enable".

command = PRO_UPLOAD

■ **dst_path (required)**

Specify the path to the folder (250 or less characters) where the uploaded project file will be saved.
Use "B:\\" for a USB flash drive.

Common items

■ **title**

Enter a title for the button label using 1 line of 14 characters or less.

- When using a semicolon (;), backslash (\), or double quotations ("), a backslash (\) as an escape character will be automatically inserted before those characters and will thus be calculated as 2 single-byte characters.

[COMMENT] section

■ **comment**

Enter a comment using 1 line of 29 characters or less.

- When using a semicolon (;), backslash (\), or double quotations ("), an escape character (\) will be automatically inserted before those characters and will thus be calculated as 2 single-byte characters.

Notes on comments

To add comments to the USB Autorun definition file, use a semicolon (;).

All text after the semicolon (;) and up to the line feed will be treated as a non-executable comments.

Restrictions

- The maximum number of characters per line is 512 single-byte characters including line feed codes. All the text on the line will be ignored if there are more than 512 single-byte characters on the line.
- Each item must be described as a single line. If a line feed occurs before the end of the description, all characters after the line feed are ignored.
- The maximum size of the USB Autorun definition file (hgauto.ini) is 512 KB. The file cannot be used if it exceeds this limit.
- Only line feed codes of the format generally supported by Windows (CR+LF) are supported. If any other format is used, the USB Autorun definition file (hgauto.ini) will fail to run properly.

Sample definition file and explanation

Sample definition

```

; sample hgauto.ini
(1) [AUTORUN]
    item = 5 ; number of items
    button_command = Enable ; enable individual command buttons
    button_runall = Enable ; enable the "Run All" button.
    language = English ; use English

(2) [COMMAND_1]
    command = PRO_DOWNLOAD ; download the project file
    src_path = "B:\FT_DEMO_1.ZNV" ; source path
    title = "Change Program" ; button label

(3) [COMMAND_2]
    command = PRO_UPLOAD ; upload a project file
    dst_path = "B:\Uploaded_Project" ; destination path
    title = "Copy Program" ; button label

(4) [COMMENT]
    comment = "Press the button." ; Message shown at bottom of screen.

```

Explanation

(1) This definition file displays two command execution buttons on the menu screen displayed by the USB Autorun function. It also enables the **Run All** button. All button labels and messages are displayed in English.

[AUTORUN]	Defines the number of commands to use and details about the menu screen.
item = 2	Specifies that two commands will be used.
button_command = Enable	Enables execution buttons for each command from [COMMAND_1] to [COMMAND_2].
button_runall = Enable	Enables the Run All button.
language = English	Displays all button labels and messages in English.

(2) Downloading a project file from a USB flash drive to the Touch.

[COMMAND_1]	Defines the command assigned to execution button [COMMAND_1]. This is the first command that executes when Run All is touched.
command = PRO_DOWNLOAD	Executes "Download a project file".
src_path = "B:\FT_DEMO_1.ZNV"	Downloads the project file "FT_DEMO_1.ZNV" saved on the USB flash drive (B:) to the Touch.
title = "Change Program"	Displays the text "Change Program" as the button label.

(3) Uploading a project to a USB flash drive.

[COMMAND_2]	Defines the command assigned to execution button [COMMAND_2]. This is the fourth command that executes when Run All is touched.
command = PRO_UPLOAD	Executes "Upload a project file".
dst_path = "B:\Uploaded_Project"	Uploads the project file used to operate the Touch and saves it to the Uploaded_Project folder on the USB flash drive (B:).
title = "Copy Program"	Displays the text "Copy Program" as the button label.

(4) Displays messages below the menu screen for the USB Autorun function.

[COMMENT]	Defines the number of commands to use and details about the menu screen.
comment = "Press the button."	Displays the text "Press the button." below the menu screen.

2.4 USB Autorun Function Security

If security has been enabled for the Touch project, Touch displays the Password Screen when the USB Autorun function runs.

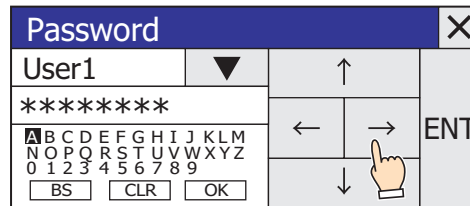

Select the user name from the security group that has command execution permissions, enter the password, and touch **ENT**.

- Execution privileges by security groups

With the Touch, a password-authenticated user account with the security group "Administrator" is necessary.

Command	Security Group		
	Administrator	Operator	Reader
Downloading a project file	YES	NO	NO
Uploading a project file	YES	NO	NO



If you press  (Close) instead of entering a password, no commands are executed and the menu screen closes. To re-execute the USB Autorun function, insert the USB flash drive again.

Chapter 27 Internal Devices

This chapter describes internal devices available for the SmartAXIS.

The Touch includes an internal HMI device to control HMI functions, and control device for control functions.

1 Bit Devices

1.1 HMI Device Addresses

Internal Device Name	Symbol	R/W	Address Range	Base
HMI Internal Relay	LM	R/W	0 to 2,047	10
HMI Keep Relay	LK	R/W	Variable	10
HMI Temporary Relay	LBM	R/W	0 to 127	10
HMI Special Internal Relay	LSM	R/W	0 to 63	10
HMI Timer Relay	LTC	R	0 to 31	10



R/W stands for Read/Write. R/W enables reading and writing of values, whereas R enables reading only.

■ HMI Internal Relay (LM)

This is a bit-unit device used for the HMI function. It can store 2,048 addresses.

■ HMI Keep Relay (LK)

This is a bit-unit device that holds the values of device used for the HMI function. The value of this device can be set to 0 by clearing the project data download option or online function, or it becomes zero if the backup battery is drained. The address range can be varied between 1,024 and 8,192. For details, refer to Chapter 16 “Minimum and Maximum Amount of Data Storage and Number of Addresses” on page 16-2.

■ HMI Temporary Relay (LBM)

This is a bit-unit device for temporarily storing values for the HMI function. The value of this device switches between screens and text groups and user accounts, and it becomes 0 if the screen is reset. It can store 128 addresses.

■ HMI Special Internal Relay (LSM)

Special functions are assigned to each bit by the bit-unit device. It can store 64 addresses.

Address	Function/Part
LSM0	Normally set to 1.
LSM1	1 only on the second scan when Base Screen is switched. It also operates when switching text group or user account, or resetting the display screen.
LSM2	1 only on the first scan when Base Screen is switched. It also operates when switching text group or user account, or resetting the display screen.
LSM3	0 only on the first scan when Base Screen is switched. It also operates when switching text group or user account, or resetting the display screen.
LSM4	Alternates between 0 and 1 on each scan of the Touch.
LSM5	1 only on the first scan when Popup Screen is opened.
LSM6	1 while touch panel is pressed.
LSM7	Alternates between 0 and 1 each time data is read (read scan) from all the external devices being used.
LSM8	After powering ON value is 1 until the initially displayed screen switches to another screen.
LSM9	When value changes from 0 to 1, the backup data stored in flash memory is restored. When it becomes 1 value does not become 0 until the Touch is reset or 0 is written.
LSM10	When value changes from 0 to 1, the data of Keep Relay and Keep Register configured in the Data Storage Area, and the current backlight settings are transferred to flash memory. When it becomes 1 value does not become 0 until the Touch is reset or 0 is written.

Address	Function/Part
LSM11	Changes from 0 to 1 when the Base Screen is switched, after the values of all the external devices being used are read, and remains 1 until there is a switch to another screen. It also operates when switching text group or user account, or resetting the display screen.
LSM12	1 only on the first scan when Popup Screen is closed.
LSM13	Value becomes 0 when Popup Screen is opened, and then changes from 0 to 1 after all the values of all the external devices being used by that Popup Screen are read.
LSM14	When the indirect value of an indirect device positioned on the Base Screen changes, value becomes 1, and reading of the indirect device starts. When reading is complete value becomes 0.
LSM15	When the indirect value of an indirect device positioned on a Popup Screen changes, value becomes 1, and reading of the indirect device starts. When reading is complete value becomes 0.
LSM16 to 17	Reserved
LSM18	When value changes from 0 to 1, access to USB flash drive is stopped. The access state can be checked with the value of LSM19. When it becomes 1 value does not become 0 until the Touch is reset or 0 is written.
LSM19	Value is 1 while there is access to USB flash drive. If value is 0 the USB flash drive can be safely ejected.
LSM20 to 21	Reserved
LSM22	This is the Operation Log function. When data in excess of the amount that can be recorded in one operation occurs, the value becomes 1. When it becomes 1 value does not become 0 until the Touch is reset or 0 is written.
LSM23 to 24	Reserved
LSM25	Value is 1 while data is being written to USB flash drive.
LSM26 to 47	Reserved
LSM48	200 millisecond clock (alternates between 0 and 1 every 100 milliseconds)
LSM49	1 second clock (alternates between 0 and 1 every 500 milliseconds)
LSM50 to 52	Reserved
LSM53	When the value changes to 1, the preset values for IP address, subnet mask, and default gateway (LSD192 to 203) are written to the Touch, then it automatically resets. After the Touch is reset, the value becomes 0.
LSM54 to 63	Reserved



- Since the HMI Special Internal Relay can be written to, even if a write is attempted, the contents will not change.
- Transfer of the LSM10 Keep Relay and Keep Register to the flash memory can take an excess of one second. Writing to the flash memory can be repeated a maximum of 100,000 times. Keep writing to the flash memory to a minimum. LSM10 cannot be used while the ladder program is running. LSM10 does not work while the ladder program or FBD program is running.
- When there is no remaining battery power, data transferred with LSM10 will be restored once the power to the Touch has been turned on.



The period of processing for all of the parts set on the displayed screen is called a scan of the Touch. It is not related to the period of reading the value of external devices.

A timing chart for the HMI Special Internal Relay controlled by operation of the Touch is shown below.

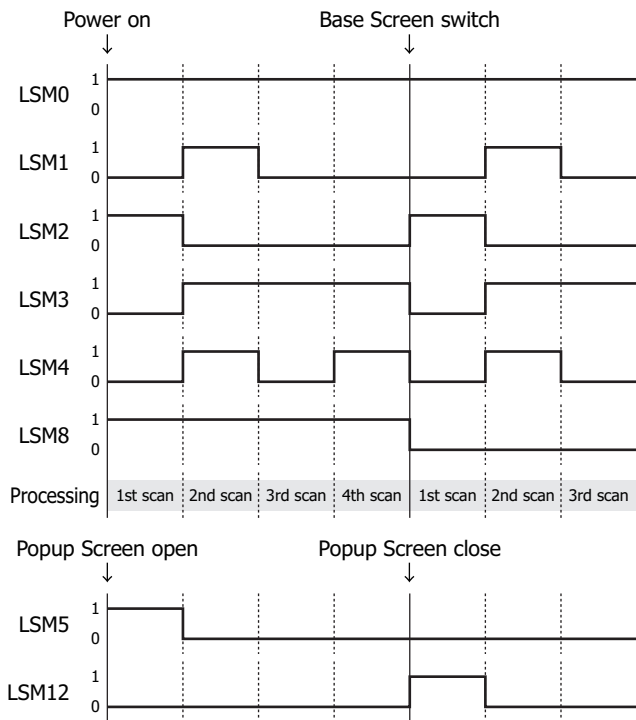

■ **HMI Timer Relay (LTC)**

The HMI Timer is a bit-unit device that can be changed to 1 in value of device switched by the Timer from Parts. It can store 32 addresses.

1.2 Control Device Addresses

Internal Device Name	Symbol	R/W	Address Range	Base
Input	I	R	0 to 17	8
Output	Q	R/W	0 to 13	8
Remote Input	I	R	40 to 75 80 to 115 120 to 155	8
Remote Output	Q	R/W	40 to 61 80 to 101 120 to 141	8
Timer Bit	T	R	000 to 199	10
Counter Bit	C	R	000 to 199	10
Shift Register	R	R/W	0 to 127	10
Internal Relay	M	R/W	0 to 1277	10*1
Special Internal Relay	M	R/W	8000 to 8177	10*1



R/W stands for Read/Write. R/W enables reading and writing of values, whereas R enables reading only.

■ Input (I)

Inputs (I) are relays to receive input signals through the input terminals.

■ Output (Q)

Outputs (Q) are relays to send the processed results to the output terminals.

■ Remote Input (I)

Remote inputs (I) are devices to input the on/off state from external devices connected to remote I/O slaves to the Touch.

■ Remote Output (Q)

Remote outputs (Q) are devices to output the on/off information from the Touch to external devices connected to remote I/O slaves.

■ Timer (T)

Control device timers are bit unit devices that become 1 when the time is up.

■ Counter (C)

Control device counters are bit unit devices that become 1 when the count is up.

■ Shift registers (R)

Shift registers (R) are registers to shift the data bits according to pulse inputs.

■ Internal Relay (M)

Internal relays (M) are relays used in the Touch and cannot be outputted to the output terminals.



- Control devices must have a "#" before the device type only when the WindO/I-NV3 is used. In addition, on the Device Monitor a "#" is displayed before the device type.

Example: When setting D100

WindO/I-NV3: #D100

WindLDR: D100

- Values can only be written from the HMI function to outputs (Q) while the ladder program or FBD program is running.
- Do not simultaneously write values to the same control device using the HMI function and the control function.
- Operations in scripts of control function are as follows.
 - Bit of Data register can be handled as a bit device.
 - Calculations in which both bit and word devices are used are not allowed.
 - Bit devices are always processed as bits, and values of those devices are 0(OFF) or 1(ON).

*1 The last digit of the device address is 0 to 7 in octal notation.

■ Special Internal Relay (M)

Special internal relays (M) are bit devices used internally on the Touch. Each bit has been assigned a special function.



Although the device code for internal relays (M0000 to M1277) and special internal relays (M8000 to M8177) is the same ("M"), the device characteristics are different. Special functions are assigned to each bit of the special internal relay.



Do not change the status of reserved special internal relays, otherwise the Touch may not operate correctly.

Device Address	Description	CPU Stopped	Power OFF	Read/Write	Ladder	FBD	
M8000	Start Control M8000 controls the state of the ladder program or FBD program (RUN/STOP). When M8000 is turned on, the ladder program or FBD program is executed, and when turned off, the ladder program or FBD program stops. Stop input and reset input have precedence over M8000 (start control). M8000 maintains its status when the Touch is powered down. When the data to be maintained during power failure is broken after the Touch has been off for a period longer than the battery backup duration, the Touch restarts ladder program operation or FBD program operation or not as selected in Configuration, Run/Stop Control, Run/Stop Selection at Memory Backup Error . For details, refer to Chapter 3 "4.4 Run/Stop Selection at Memory Backup Error" on page 3-51.	Maintained	Maintained	Write	YES	YES	
M8001	1-sec Clock Reset While M8001 is on, M8121 (1-sec clock) is turned off.	Cleared	Cleared	Write	YES	YES	
M8002	All Outputs OFF When M8002 is turned on, all outputs go off until M8002 is turned off. Self-maintained circuits using outputs also go off and are not restored when M8002 is turned off.	Cleared	Cleared	Write	YES	YES	
M8003	Carry (Cy) and Borrow (Bw) When a carry or borrow results from executing an addition or subtraction instruction, M8003 turns on. For details, refer to Chapter 4 "Instructions Reference" – "Carry and Borrow" in the "SmartAXIS Ladder Programming Manual".	Cleared	Cleared	Read	YES	—	
M8004	Program Execution Error When an error occurs while executing a ladder program or FBD program, M8004 turns on. For details, refer to Chapter 30 "2.2 Program Execution Error" on page 30-5.	Cleared	Cleared	Read	YES	YES	
M8005	Remote I/O Slave Communication Error Special internal relays used by remote I/O. For details, refer to Chapter 12 "4.2 Remote I/O Master" on page 12-47.	Remote I/O Slave 1 Communication Error	Operating	Cleared	Read	YES	YES
M8006		Remote I/O Slave 2 Communication Error	Operating	Cleared	Read	YES	YES
M8007		Remote I/O Slave 3 Communication Error	Operating	Cleared	Read	YES	YES
M8010	In Daylight Saving Time Period When the daylight saving time is enabled, M8010 is turned on while in the daylight saving time period. When the daylight saving time is disabled, M8010 is always off.	Operating	Cleared	Read	YES	YES	
M8011, 8012	Reserved	—	—	—	—	—	
M8013	Calendar/Clock Data Write/Adjust Error Flag When an error occurs while calendar/clock data is written or clock data is adjusted, M8013 turns on. If calendar/clock data is written or clock data is adjusted successfully, M8013 turns off.	Operating	Cleared	Read	YES	YES	
M8014	Calendar/Clock Data Read Error Flag When an error occurs while calendar/clock data is read from the internal clock to the special data registers (D8008 to D8014), M8014 turns on. If calendar/clock data is read successfully, M8014 turns off.	Operating	Cleared	Read	YES	YES	
M8015	Reserved	—	—	—	—	—	

Device Address	Description	CPU Stopped	Power OFF	Read/Write	Ladder	FBD	
M8016	Calendar Data Write Flag When M8016 is turned on, data in data registers D8015 through D8018 (calendar new data) are set to the internal clock.	Operating	Cleared	Write	YES	YES	
M8017	Clock Data Write Flag When M8017 is turned on, data in data registers D8019 through D8021 (clock new data) are set to the internal clock.	Operating	Cleared	Write	YES	YES	
M8020	Calendar/Clock Data Write Flag When M8020 is turned on, data in data registers D8015 through D8021 (calendar/clock new data) are set to the internal clock.	Operating	Cleared	Write	YES	YES	
M8021	Clock Data Adjust Flag When M8021 is turned on, the clock is adjusted with respect to seconds. If seconds are between 0 and 29 for current time, adjustment for seconds will be set to 0 and minutes remain the same. If seconds are between 30 and 59 for current time, adjustment for seconds will be set to 0 and minutes are incremented by 1.	Operating	Cleared	Write	YES	YES	
M8022, 8023	Reserved	—	—	—	—	—	
M8024	BMOV/WSFT Executing Flag While the BMOV or WSFT is executed, M8024 turns on. When completed, M8024 turns off. If the Touch is powered down while executing BMOV or WSFT, M8024 remains on when the Touch is powered up again.	Maintained	Maintained	Read	YES	—	
M8025	Maintain Outputs While Ladder Program Operation Stopped Outputs are normally turned off when the ladder program operation is stopped. M8025 is used to maintain the output statuses when the ladder program operation is stopped. When the ladder program operation is stopped with M8025 turned on, the output ON/OFF statuses are maintained. When the ladder program operation restarts, M8025 is turned off automatically.	Maintained	Cleared	Write	YES	YES	
M8026, 8027	Reserved	—	—	—	—	—	
M8030	Special Internal Relays for High-Speed Counter (Group 1/10) For details, refer to Chapter 3 "4.7 High-Speed Counter" on page 3-55.	Comparison Output Reset	Cleared	Cleared	Read/Write	YES	YES*1
M8031		Gate Input	Maintained	Cleared	Read/Write	YES	YES*1
M8032		Reset Input	Maintained	Cleared	Read/Write	YES	YES*1
M8033		Reset Status	Maintained	Cleared	Read	YES	YES
M8034		Comparison ON Status	Maintained	Cleared	Read	YES	YES
M8035		Overflow	Maintained	Cleared	Read	YES	YES
M8036		Underflow	Maintained	Cleared	Read	YES	YES
M8037		Count Direction	Maintained	Cleared	Read	YES	YES
M8040	Special Internal Relays for High-Speed Counter (Group 2/12) For details, refer to Chapter 3 "4.7 High-Speed Counter" on page 3-55.	Comparison Output Reset	Cleared	Cleared	Read/Write	YES	YES*1
M8041		Gate Input	Maintained	Cleared	Read/Write	YES	YES*1
M8042		Reset Input	Maintained	Cleared	Read/Write	YES	YES*1
M8043		Comparison ON Status	Maintained	Cleared	Read	YES	YES
M8044		Overflow	Maintained	Cleared	Read	YES	YES
M8045 to 8047, 8050 to 8054	Reserved	—	—	—	—	—	

*1 Read only

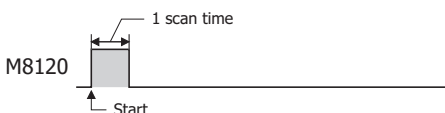
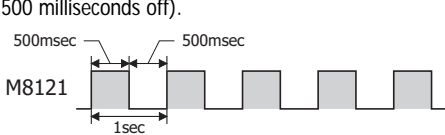
Device Address	Description		CPU Stopped	Power OFF	Read/Write	Ladder	FBD	
M8055	Comparison Output Reset		Cleared	Cleared	Read/Write	YES	YES*1	
M8056	Special Internal Relays for High-Speed Counter (Group 3/13) For details, refer to Chapter 3 "4.7 High-Speed Counter" on page 3-55.		Gate Input	Maintained	Cleared	Read/Write	YES	YES*1
M8057			Reset Input	Maintained	Cleared	Read/Write	YES	YES*1
M8060			Comparison ON Status	Maintained	Cleared	Read	YES	YES
M8061			Overflow	Maintained	Cleared	Read	YES	YES
M8062 to 8067, 8070			Reserved		—	—	—	—
M8071	Interrupt Input I2 Status	Turns on when the corresponding user interrupt is allowed. When interrupt inputs are disabled, these internal relays are turned off. (ON: Allowed, OFF: Prohibited)	Cleared	Cleared	Read	YES	—	
M8072	Interrupt Input I3 Status		Cleared	Cleared	Read	YES	—	
M8073	Interrupt Input I4 Status		Cleared	Cleared	Read	YES	—	
M8074	Interrupt Input I5 Status		Cleared	Cleared	Read	YES	—	
M8075 to 8077, 8080	Reserved		—	—	—	—	—	
M8081	Interrupt Input I2 Edge	This flag indicates whether the interrupt input is triggered with a rising edge or falling edge. (ON: Rising, OFF: Falling)	Cleared	Cleared	Read	YES	—	
M8082	Interrupt Input I3 Edge		Cleared	Cleared	Read	YES	—	
M8083	Interrupt Input I4 Edge		Cleared	Cleared	Read	YES	—	
M8084	Interrupt Input I5 Edge		Cleared	Cleared	Read	YES	—	
M8085 to 8087, 8090	Reserved		—	—	—	—	—	
M8091	Catch Input ON/OFF Status	Group 2/I2	Maintained	Cleared	Read	YES	YES	
M8092	When a rising or falling input edge is detected during a scan, the input statuses of catch inputs Group 1/I0 through Group 6/I7 at the moment are set to M8090 through M8095, respectively, without regard to the scan status. Only one edge is detected in one scan.	Group 3/I3	Maintained	Cleared	Read	YES	YES	
M8093		Group 4/I4	Maintained	Cleared	Read	YES	YES	
M8094		Group 5/I6	Maintained	Cleared	Read	YES	YES	
M8095 to M8107	Reserved		—	—	—	—	—	
M8110	Connection Status	Remote I/O Slave 1 Connection Status	Operating	Cleared	Read	YES	YES	
M8111	Special internal relays used by remote I/O. For details, refer to Chapter 12 "4.2 Remote I/O Master" on page 12-47.	Remote I/O Slave 2 Connection Status	Operating	Cleared	Read	YES	YES	
M8112		Remote I/O Slave 3 Connection Status	Operating	Cleared	Read	YES	YES	
M8113 to 8117	Reserved		—	—	—	—	—	
M8120	Initialize Pulse When the ladder program starts running, M8120 turns on for a period of one scan.			Cleared	Cleared	Read	YES	YES
M8121	1-sec Clock While M8001 (1-sec clock reset) is off, M8121 generates clock pulses in one second increments, with a duty ratio of 1:1 (500 milliseconds on and 500 milliseconds off).			Operating	Cleared	Read	YES	YES

*1 Read only

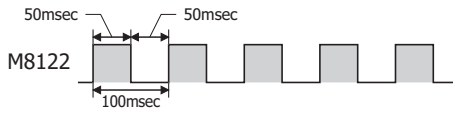
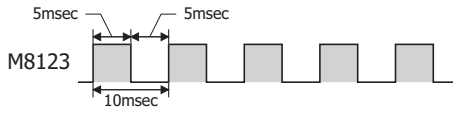
Device Address	Description	CPU Stopped	Power OFF	Read/Write	Ladder	FBD	
M8122	<p>100-msec Clock M8122 always generates clock pulses in 100 milliseconds increments, whether M8001 is on or off, with a duty ratio of 1:1 (50 milliseconds on and 50 milliseconds off).</p> 	Operating	Cleared	Read	YES	YES	
M8123	<p>10-msec Clock M8123 always generates clock pulses in 10 milliseconds increments, whether M8001 is on or off, with a duty ratio of 1:1 (5 milliseconds on and 5 milliseconds off).</p> 	Operating	Cleared	Read	YES	YES	
M8124	<p>Timer/Counter Preset Value Changed When timer or counter preset values are changed, M8124 turns on. When a ladder program or FBD program is downloaded to the Touch or when the changed timer/counter preset value is cleared, M8124 turns off.</p>	Maintained	Cleared	Read	YES	YES	
M8125	<p>In-operation Output M8125 remains on while the ladder program is running.</p>	Cleared	Cleared	Read	YES	YES	
M8126 to 8143	Reserved	—	—	—	—	—	
M8144	<p>Timer Interrupt Status When timer interrupt is enabled, M8144 is turned on. When disabled, M8144 is turned off.</p>	Cleared	Cleared	Read	YES	—	
M8145 to 8147	Reserved	—	—	—	—	—	
M8150 to 8152	<p>Comparison Result Greater Than Each bit turns ON in accordance with the results of the CMP=(Compare(=)) command and ICMP>=(interval comparison) command. For CMP=(Compare(=)) command: M8150 = S1>S2, M8151 = S1=S2, M8152 = S1<S2 For ICMP>=(interval comparison) command: M8150=S2>S1, M8151=S3>S2, M8152=S1>S2>S3 For details about comparison results of the CMP=(Compare(=)) and ICMP>=(interval comparison) commands, refer to the "SmartAXIS Ladder Programming Manual".</p>	Maintained	Cleared	Read	YES	—	
M8153 to 8165	Reserved	—	—	—	—	—	
M8166	<p>Special Internal Relays for High-Speed Counter (Group 4/14) For details, refer to Chapter 3 "4.7 High-Speed Counter" on page 3-55.</p>	Comparison Output Reset	Cleared	Cleared	Read/Write	YES	YES*1
M8167		Gate Input	Maintained	Cleared	Read/Write	YES	YES*1
M8170		Reset Input	Maintained	Cleared	Read/Write	YES	YES*1
M8171		Comparison ON Status	Maintained	Cleared	Read	YES	YES
M8172		Overflow	Maintained	Cleared	Read	YES	YES
M8173		Comparison Output Reset	Cleared	Cleared	Read/Write	YES	YES*1
M8174		Gate Input	Maintained	Cleared	Read/Write	YES	YES*1
M8175		Reset Input	Maintained	Cleared	Read/Write	YES	YES*1
M8176		Comparison ON Status	Maintained	Cleared	Read	YES	YES
M8177	Overflow	Maintained	Cleared	Read	YES	YES	

*1 Read only

2 Word Devices

2.1 HMI Device Addresses

Internal Device Name	Symbol	R/W	Address Range	Base
HMI Data Register	LDR	R/W	0 to 8191	10
HMI Keep Register	LKR	R/W	Variable	10
HMI Temporary Register	LBR	R/W	0 to 127	10
HMI Timer (Current)	LTD	R	0 to 31	10
HMI Special Data Register	LSD	R/W	0 to 255	10



R/W stands for Read/Write. R/W enables reading and writing of values, whereas R enables reading only.

■ HMI Data Register (LDR)

8,192 points are available.

■ HMI Keep Register (LKR)

The value in these registers is retained during power OFF.

The maximum number of HMI Keep Register depends upon the number set in WindO/I-NV3. For details, refer to Chapter 16 "Minimum and Maximum Amount of Data Storage and Number of Addresses" on page 16-2.

■ HMI Temporary Register (LBR)

This register value will be cleared to 0 when a text group or user account is changed, when a screen is reset or the screen is changed. 128 points are available.

■ HMI Timer (Current value) (LTD)

HMI Timer stores the current value of Timer from the parts. 32 points are available.

■ HMI Special Data Register (LSD)

The HMI Special Data Registers (256 points) perform the following special operations.

Address	Function/Part
LSD0 to 3	Reserved
LSD4	Scan time Maximum value of the Touch (msec)
LSD5	Screen switch response time (msec)
LSD6	Read scan communication time (msec)
LSD7	Scan counter (incremented at each scan of the Touch)
LSD8	1 second counter (incremented each second)
LSD9	10 millisecond counter (increments every 10 msec)
LSD10	100 millisecond counter (incremented every 100 msec)
LSD11	200 millisecond counter (incremented every 200 msec)
LSD12	500 millisecond counter (incremented every 500 msec)
LSD13	Stores the current Year data from the Touch. "Year" (4 BCD digits)
LSD14	Stores current time data from Touch. "Month" (2 BCD digits)
LSD15	Stores current time data from Touch. "Day" (2 BCD digits)
LSD16	Stores current time data from Touch. "Hour" (2 BCD digits)
LSD17	Stores current time data from Touch. "Minute" (2 BCD digits)
LSD18	Stores current time data from Touch. "Second" (2 BCD digits)
LSD19	Stores current time data from Touch. "Day-of-week" (1 BCD digit)

Address	Function/Part
LSD20	When a value of 1 is written into this device address, the internal clock in Touch is updated according to the data stored in LSD21 to 26. It automatically resets to 0 after the update.
LSD21	Stores preset value in the Touch internal clock "Year". (2 BCD digits)
LSD22	Stores preset value in the Touch internal clock "Month". (2 BCD digits)
LSD23	Stores preset value in the Touch internal clock "Day". (2 BCD digits)
LSD24	Stores preset value in the Touch internal clock "Hour". (2 BCD digits)
LSD25	Stores preset value in the Touch internal clock "Minute". (2 BCD digits)
LSD26	Stores preset value in the Touch internal clock "Second". (2 BCD digits)
LSD27	Current value of the scan time for Touch (msec)
LSD28	Minimum value of the scan time for Touch (msec)
LSD29, 30	Reserved
LSD31	Stores the currently displayed screen number.
LSD32	Set a value (in reference to a Base Screen number you want to switch to) and it will automatically switch to a specified Base Screen number. Note, after switching to a Base Screen, the value stored automatically resets to 0.
LSD33	USB flash drive error status 0: Normal 1: USB flash drive not inserted/incompatible memory 2: Formatting error 3: Access error/insufficient free space/read-write failure
LSD34	USB flash drive available capacity lower word (kB)
LSD35	USB flash drive available capacity upper word (kB)
LSD36	USB flash drive full capacity lower word (kB)
LSD37	USB flash drive full capacity upper word (kB)
LSD38	Ladder program or FBD program processing time (msec)
LSD39 to 48	Reserved
LSD49	O/I Link Slave station number
LSD50	The sequence value of the message number (or channel number if the alarm function is being used) selected by the cursor in the Alarm List Display is stored. A value of between 1 and 1024 (allocated using ((project No. - 1) x 16 + bit position + 1)) is stored for the number.
LSD51	Color or Monochrome LCD models: Brightness Adjustment 0 to 31
LSD52	The ID number of the script for which the error occurred
LSD53	Script error status
LSD54	Reserved
LSD55	Monochrome LCD models: Contrast Adjustment 0 to 31
LSD56	The number of lines of data from the start line to the line currently selected with the cursor displayed in the Alarm List Display/Alarm Log Display is stored.
LSD57	The number of log data pieces stored in the Data Storage Area by the Alarm Log function is stored. (0 to 1,024)
LSD58	USB flash drive download status During download of a file to USB flash drive with WindO/I-NV3 the following bits turns ON. When downloading is complete, the bit turns OFF. Bit 2: Recipe data Bit 4: Project data
LSD59 to 66	Reserved
LSD67	Stores the connection status for TCP clients and the TCP server for the User Communication set to the Ethernet interface. Bit 0: User Communication 1 Bit 1: User Communication 2 Bit 2: User Communication 3

Address	Function/Part
LSD68	When the value changes from 0 to 1, the connections for the TCP clients and the TCP server for the User Communication set to the Ethernet interface are forcibly disconnected. Bit 0: User Communication 1 Bit 1: User Communication 2 Bit 2: User Communication 3
LSD69 to 100	Reserved
LSD101	Polling period register for the O/I Link Slave
LSD102	Slave registration setting register for O/I Link Master
LSD103	Reserved
LSD104	Slave online information register for O/I Link Master
LSD105	Reserved
LSD106	Slave error information register for O/I Link Master
LSD107 to 111	Reserved
LSD112 to 127	Refer to details on registers for communication drivers in "External Device Setup Manual".
LSD128 to 191	Reserved
LSD192 to 195	The preset value for IP address of the Touch. When the value of LSM53 is changed to 1, the values of these device addresses are written to the Touch. When the power is turned on, the set values of the project are read to these device addresses. Example: The IP address is 192.168.0.1 LSD192=192, LSD193=168, LSD194=0, LSD195=1
LSD196 to 199	The preset value for subnet mask of the Touch. When the value of LSM53 is changed to 1, the values of these device addresses are written to the Touch. When the power is turned on, the set values of the project are read to these device addresses. Example: The subnet mask is 255.255.254.0 LSD196=255, LSD197=255, LSD198=254, LSD199=0
LSD200 to 203	The preset value for default gateway of the Touch. When the value of LSM53 is changed to 1, the values of these device addresses are written to the Touch. When the power is turned on, the set values of the project are read to these device addresses. Example: The default gateway is 192.168.0.24 LSD200=192, LSD201=168, LSD202=0, LSD203=24
LSD204 to 255	Reserved



- LSD4 and 6 store the maximum value, and when the Base Screen is switched, they are reset.
- The values of LSD4 to 6 are included errors of +/- 10 milliseconds.
- The values of LSD38 to 40 are included errors of +/- 10 milliseconds.
- When registers LSD7, 8, 9, 10, 11 or 12 contain FFFF (H) and are incremented, the value becomes 0.
- When you reckon time by using LSD9, the time difference (in 10 milliseconds units) from the previous value can be calculated.
- The range for the "Year" in LSD13 is 2000 to 2099, and reverts to 2000 after 2099.
- When 1 is written to LSD20, internal clock is updated by the contents of LSD21 to 26. Note that if there is even 1 incorrect data item in LSD21 to 26, the internal clock of the Touch is not updated.
- The display format for LSD31 is set under Screen No. Format in Project Settings. (BCD, BIN)
- This data format for LSD32 is the same as Screen No. Format in Project Settings. (BCD, BIN)
If the screen number is not exist in the project, "No Screen Data" message will appear.
If 0xFFFF(Hex) is written to LSD32, Touch will display the Top Page in the System Mode.
In case that the current screen is changed by System Area 1 and LSD32 at the same instant, the screen number of the System Area 1 will be displayed.
- By using the LSD50 value in the Message Switching Display you can display the message that corresponds to the cursor in the Alarm List Display.
- Refer to Chapter 20 "1.4 Script Error of HMI Function" on page 20-4 regarding LSD52 and LSD53.
- LSM7 and LSD6, 102 to 107 are not available for slave units when using O/I Link Communication.

2.2 Control Device Addresses

Device Name	Symbol	R/W	Address Range	Base
Input	WI	R	0,40,60,80,100,120,140	10
Output	WQ	R/W	0,40,60,80,100,120,140	10
Shift Register	WM	R/W	0 to 112 ^{*2}	10
Internal Relay	WR	R/W	0 to 1260 ^{*1}	10
Special Internal Relay	WM	R/W	8000 to 8160 ^{*1}	10
Timer Setting Value	TP	R/W	000 to 199	10
Timer Count Value	TC	R	000 to 199	10
Counter Setting Value	CP	R/W	000 to 199	10
Counter Count Value	CC	R	000 to 199	10
Data Register	D	R/W	0000 to 1999	10
Special Data Register	D	R/W	8000 to 8199	10



R/W stands for Read/Write. R/W enables reading and writing of values, whereas R enables reading only.

■ Input (WI)

Devices for handling bit device inputs (I) in word units

■ Output (WQ)

Devices for handling bit device outputs (Q) in word units

■ Shift Register (WR)

Devices for handling bit device shift registers (R) in word units

■ Internal Relay (WM)

Devices for handling bit device internal relays (M) in word units

■ Special Internal Relay (WM)

Devices for handling bit device special internal relays (M) in word units

■ Timer (TP, TC)

This timer is used internally by the Touch. These can be used as an ON delay Timer or OFF delay Timer.

■ Counter (CP, CC)

This counter is used internally by the Touch. These can be used as an addition type counter or reverse counter.

■ Data Register (D)

This is a word unit device used for storing numerical data internally in the Touch. It can also be used as a bit unit device.



- Control devices must have a "#" before the device type only when the WindO/I-NV3 is used. In addition, on the Device Monitor a "#" is displayed before the device type.

Example: When setting D100

WindO/I-NV3: #D100

WindLDR: D100

- Do not simultaneously write values to the same control device using the HMI function and the control function.
- Operations in scripts of control function are as follows.
 - Bit of Data register can be handled as a bit device.
 - Calculations in which both bit and word devices are used are not allowed.
 - Bit devices are always processed as bits, and values of those devices are 0(OFF) or 1(ON).

*1 Multiples of 20 only

*2 Multiples of 16 only

■ Special Data Register (D)

This is a word unit device used for storing numerical data internally in the Touch. Each data register is assigned a special function. It can also be used as a bit unit device.



Although the device code for the data registers (D0000 to D1999) and special data registers (D8000 to D8199) is the same ("D"), the device characteristics are different. Special functions are assigned to each special data register.



Do not change the data of reserved area, otherwise the Touch may not operate correctly.

Device Address	Description	Updated	Ladder	FBD	
D8000	Quantity of Inputs The total of input points provided on the Touch is stored to D8000.	When I/O initialized	YES	YES	
D8001	Quantity of Outputs The total of output points provided on the Touch is stored to D8001.	When I/O initialized	YES	YES	
D8002	CPU Module Type Information Information about the Touch is stored to D8002. 0: SmartAXIS Pro/Lite 12-I/O type 1: SmartAXIS Pro/Lite 24-I/O type 2: SmartAXIS Pro/Lite 40-I/O type 3: SmartAXIS Pro/Lite 48-I/O type 4: SmartAXIS Touch	Power-up	YES	YES	
D8003, 8004	Reserved	—	—	—	
D8005	General Error Code SmartAXIS general error information is stored to D8005. When a general error occurs, the bit corresponding to the error occurred turns on. The general error and the program execution error can be cleared by writing "1" to the most significant bit of D8005 using a ladder program or FBD program. For details, refer to Chapter 30 "2.1 General Error Codes" on page 30-3.	When error occurred	YES	YES	
D8006	Program Execution Error Code The ladder program or FBD program execution error information is stored to D8006. When a program execution error occurs, the error code corresponding to the error occurred is stored to D8006. For details, refer to Chapter 30 "2.2 Program Execution Error" on page 30-5.	When error occurred	YES	YES	
D8007	Reserved	—	—	—	
D8008	Calendar/Clock Current Data (Read only) Used to read calendar and clock data from the internal clock.	Year	Every 500 msec	YES	YES
D8009		Month	Every 500 msec	YES	YES
D8010		Day	Every 500 msec	YES	YES
D8011		Day of Week	Every 500 msec	YES	YES
D8012		Hour	Every 500 msec	YES	YES
D8013		Minute	Every 500 msec	YES	YES
D8014		Second	Every 500 msec	YES	YES
D8015		Year	—	YES	YES
D8016		Month	—	YES	YES
D8017		Day	—	YES	YES
D8018	Calendar/Clock New Data (Write only) Used to write calendar and clock data to the internal clock.	Day of Week	—	YES	YES
D8019		Hour	—	YES	YES
D8020		Minute	—	YES	YES
D8021		Second	—	YES	YES

Device Address	Description		Updated	Ladder	FBD	
D8022	Reserved		—	—	—	
D8023	Scan Time Data These are special data registers for checking the scan time. For details, refer to Chapter 12 "Control function" on page 12-2.	Scan Time Current Value	Every scan	YES	YES	
D8024		Scan Time Maximum Value	At occurrence	YES	YES	
D8025		Scan Time Minimum Value	At occurrence	YES	YES	
D8026 to 8032	Reserved		—	—	—	
D8033	Interrupt Input Jump Destination Label No. Jump destination label numbers for interrupt inputs are stored in these special data registers. To use interrupt inputs, store the label number that corresponds to the special data register allocated to the interrupt input. For details, refer to Chapter 3 "4.9 Interrupt Input" on page 3-74.	I2	—	YES	—	
D8034		I3	—	YES	—	
D8035		I4	—	YES	—	
D8036	Timer Interrupt Jump Destination Label No. The jump destination label number when the timer interrupt occurs is stored in D8036. To use the timer interrupt, store the corresponding label number. For details, refer to Chapter 3 "4.13 Timer Interrupt" on page 3-84.		—	YES	—	
D8037	Interrupt Input Jump Destination Label No. Jump destination label numbers for interrupt inputs are stored in these special data registers. To use interrupt inputs, store the label number that corresponds to the special data register allocated to the interrupt input. For details, refer to Chapter 3 "4.9 Interrupt Input" on page 3-74.	I5	—	YES	—	
D8038, 39	Reserved		—	—	—	
D8040	Analog Input Value The analog input values to the analog input terminals are converted to digital values (0 to 1000) and stored to the corresponding special data registers. For FBD, a linear transformation can be configured for the analog input (AI). Even when a linear transformation is configured for AI, the special data registers store the analog values (0 to 1000) before the linear transformation. D8040=AI0, D8041=AI1	AI0	Every scan	YES	YES	
D8041		AI1	Every scan	YES	YES	
D8042	Analog Input Status The analog input status to the analog input terminals is stored to the corresponding special data registers. For details, refer to Chapter 3 "4.12 Analog Input" on page 3-81. D8042 = AI0, D8043 = AI1	AI0	Every scan	YES	YES	
D8043		AI1	Every scan	YES	YES	
D8044	Analog Output Value The analog output values to the analog output terminals are stored to the corresponding special data registers in digital values. For details, refer to Chapter 3 "4.14 Analog Output" on page 3-86. D8044 = AQ0, D8045 = AQ1	AQ0	Every scan	YES	YES	
D8045		AQ1	Every scan	YES	YES	
D8046	Analog Output Status The analog output status to the analog output terminals is stored to the corresponding special data registers. For details, refer to Chapter 3 "4.14 Analog Output" on page 3-86. D8046 = AQ0, D8047 = AQ1	AQ0	Every scan	YES	YES	
D8047		AQ1	Every scan	YES	YES	
D8048, D8049	Reserved		—	—	—	
D8050	High-Speed Counter (Group 1/10) These special data registers are used with the high-speed counter function. For details, refer to Chapter 3 "4.7 High-Speed Counter" on page 3-55.	Upper Word	Current Value	Every scan	YES	YES
D8051		Lower Word				
D8052		Upper Word	Preset Value	—	YES	YES
D8053		Lower Word				
D8054		Upper Word	Reset Value	—	YES	YES
D8055		Lower Word				

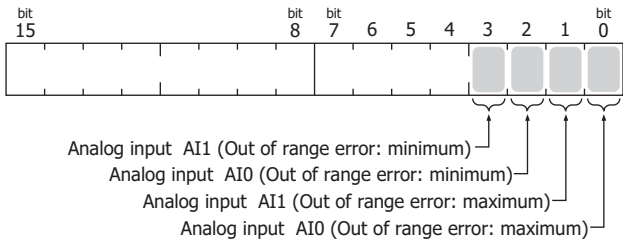
Device Address	Description	Updated	Ladder	FBD		
D8056	High-Speed Counter (Group 2/12)	Upper Word	Current Value / Frequency	Every scan	YES	YES
D8057	These special data registers are used with the high-speed counter function and the frequency measurement function.	Lower Word	Measurement Value (12)	—	YES	YES
D8058		Upper Word	Preset Value			
D8059		Lower Word				
D8060		Upper Word	Reset Value	—	YES	YES
D8061	Lower Word					
D8062 to 8067	Reserved	—	—	—	—	—
D8068	High-Speed Counter (Group 3/13)	Upper Word	Current Value / Frequency	Every scan	YES	YES
D8069	These special data registers are used with the high-speed counter function and the frequency measurement function.	Lower Word	Measurement Value (13)	—	YES	YES
D8070		Upper Word	Preset Value			
D8071		Lower Word				
D8072		Upper Word	Reset Value	—	YES	YES
D8073	Lower Word					
D8074 to 8076	Reserved	—	—	—	—	—
D8077	<p>Out of Analog Input Range Status</p> <p>If the analog input signal exceeds 11 V or 21 mA, the corresponding bits of D8077 (bit 0, 1) become 1. If the signal falls below 11 V or 21 mA, the bits become 0.</p> <p>If the analog input signal falls below 2 mA, the corresponding bits of D8077 (bit 2, 3) become 1. If the signal exceeds 2 mA, the bits become 0.</p> <p>The assignment of each analog input is as follows.</p> 	—	YES	YES		
D8078 to 8109	Reserved	—	—	—	—	—
D8110 to 8113	IP Address of the Connected Slave	IP Address of the Connected Slave 1	Each second	YES	YES	
D8114 to 8117	Special data registers used by remote I/O. For details, refer to Chapter 12 "4.2 Remote I/O Master" on page 12-47.	IP Address of the Connected Slave 2	Each second	YES	YES	
D8118 to 8121		IP Address of the Connected Slave 3	Each second	YES	YES	
D8122	Cartridge Slot 1 Information The information of the Cartridge Slot 1 is stored to the special data registers. For details, refer to "Cartridge Slot Information" on page 27-18.	Type ID/Status	—	YES	YES	
D8123		System Software Version	—	YES	YES	
D8124	Cartridge Slot 2 Information The information of the Cartridge Slot 2 is stored to the special data registers. For details, refer to "Cartridge Slot Information" on page 27-18.	Type ID/Status	—	YES	YES	
D8125		System Software Version	—	YES	YES	
D8126 to 8129	Reserved	—	—	—	—	
D8130	Port Number of the Connected Slave	Port Number of the Connected Slave 1	Each second	YES	YES	
D8131	Special data registers used by remote I/O. For details, refer to Chapter 12 "4.2 Remote I/O Master" on page 12-47.	Port Number of the Connected Slave 2	Each second	YES	YES	
D8132		Port Number of the Connected Slave 3	Each second	YES	YES	
D8133	Reserved	—	—	—	—	

Device Address	Description		Updated	Ladder	FBD							
D8134	High-Speed Counter(Group 4/14) These special data registers are used with the high-speed counter function and the frequency measurement function. For details, refer to Chapter 3 "4.7 High-Speed Counter" on page 3-55.	Upper Word	Current Value / Frequency Measurement Value (14)	Every scan	YES	YES						
D8135		Lower Word										
D8136		Upper Word	Preset Value				—	YES	YES			
D8137		Lower Word										
D8138		Upper Word	Reset Value							—	YES	YES
D8139		Lower Word										
D8140	High-Speed Counter (Group 5/15) These special data registers are used with the high-speed counter function and the frequency measurement function. For details, refer to Chapter 3 "4.7 High-Speed Counter" on page 3-55.	Upper Word	Current Value / Frequency Measurement Value (15)	Every scan	YES	YES						
D8141		Lower Word										
D8142		Upper Word	Preset Value				—	YES	YES			
D8143		Lower Word										
D8144		Upper Word	Reset Value							—	YES	YES
D8145		Lower Word										
D8146, 8147	Reserved		—	—	—							
D8148	Remote I/O Slave 1 Special data registers used by remote I/O. For details, refer to Chapter 12 "4.2 Remote I/O Master" on page 12-47.	Connection Error Status	When a communication error occurs	YES	YES							
D8149		Analog input (AI10)	Every scan	YES	YES							
D8150		Analog input (AI11)	Every scan	YES	YES							
D8151		Analog input (AI12)	Every scan	YES	YES							
D8152		Analog input (AI13)	Every scan	YES	YES							
D8153		Analog input (AI14)	Every scan	YES	YES							
D8154		Analog input (AI15)	Every scan	YES	YES							
D8155		Analog input (AI16)	Every scan	YES	YES							
D8156		Analog input (AI17)	Every scan	YES	YES							
D8157	Remote I/O Slave 2 Special data registers used by remote I/O. For details, refer to Chapter 12 "4.2 Remote I/O Master" on page 12-47.	Connection Error Status	When a communication error occurs	YES	YES							
D8158		Analog input (AI20)	Every scan	YES	YES							
D8159		Analog input (AI21)	Every scan	YES	YES							
D8160		Analog input (AI22)	Every scan	YES	YES							
D8161		Analog input (AI23)	Every scan	YES	YES							
D8162		Analog input (AI24)	Every scan	YES	YES							
D8163		Analog input (AI25)	Every scan	YES	YES							
D8164		Analog input (AI26)	Every scan	YES	YES							
D8165		Analog input (AI27)	Every scan	YES	YES							
D8166	Remote I/O Slave 3 Special data registers used by remote I/O. For details, refer to Chapter 12 "4.2 Remote I/O Master" on page 12-47.	Connection Error Status	When a communication error occurs	YES	YES							
D8167		Analog input (AI30)	Every scan	YES	YES							
D8168		Analog input (AI31)	Every scan	YES	YES							
D8169		Analog input (AI32)	Every scan	YES	YES							
D8170		Analog input (AI33)	Every scan	YES	YES							
D8171		Analog input (AI34)	Every scan	YES	YES							
D8172		Analog input (AI35)	Every scan	YES	YES							
D8173		Analog input (AI36)	Every scan	YES	YES							
D8174		Analog input (AI37)	Every scan	YES	YES							
D8175	Reserved		—	—	—							

Device Address	Description		Updated	Ladder	FBD
D8176	Analog Input/Output Value to the Analog Cartridge (Port 1) • For the analog input type The analog input values to the analog cartridges are converted to digital values and stored to the corresponding special data registers. • For the analog output type	AI2/AQ2	Every scan	YES	YES
D8177	The analog output values to the analog cartridges are stored to the corresponding special data registers in digital values. For details, refer to Chapter 3 "4.15 Analog Cartridge" on page 3-88. D8176 = AI2/AQ2, D8177 = AI3/AQ3	AI3/AQ3	Every scan	YES	YES
D8178	Analog Status to the Analog Cartridge (Port 1) The analog status to the analog cartridges is stored to the corresponding special data registers.	AI2/AQ2	Every scan	YES	YES
D8179	For details, refer to Chapter 3 "4.15 Analog Cartridge" on page 3-88. D8178 = AI2/AQ2, D8179 = AI3/AQ3	AI3/AQ3	Every scan	YES	YES
D8180 to 8185	Reserved		—	—	—
D8186	Analog Input/Output Value to the Analog Cartridge (Port 2) •For the analog input type The analog input values to the analog cartridges are converted to digital values and stored to the corresponding special data registers.	AI4/AQ4	Every scan	YES	YES
D8187	•For the analog output type The analog output values to the analog cartridges are stored to the corresponding special data registers in digital values. For details, refer to Chapter 3 "4.15 Analog Cartridge" on page 3-88. D8186 = AI4/AQ4, D8187 = AI5/AQ5	AI5/AQ5	Every scan	YES	YES
D8188	Analog Status to the Analog Cartridge (Port 2) The analog status to the analog cartridges is stored to the corresponding special data registers.	AI4/AQ4	Every scan	YES	YES
D8189	For details, refer to Chapter 3 "4.15 Analog Cartridge" on page 3-88. D8188 = AI4/AQ4, D8189 = AI5/AQ5	AI5/AQ5	Every scan	YES	YES
D8190 to 8199	Reserved		—	—	—

Cartridge Slot Information

The type IDs, status information, system software version of the digital I/O cartridge and the analog cartridge are written to the special data registers as the cartridge slot information. The allocation of information is as follows.

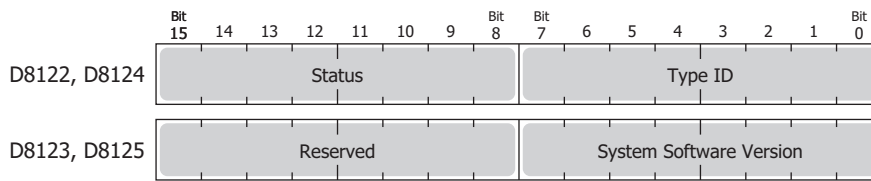

D8122, D8123 = Cartridge Slot 1 Information

D8124, D8125 = Cartridge Slot 2 Information

The system software version displays the version of the software written to the cartridge.

Type ID List

Type ID		Type Number
Hexadecimal	Binary	
0x00	0000 0000	FC6A-PJ2A
0x01	0000 0001	FC6A-PK2AV
0x02	0000 0010	FC6A-PK2AW
0x03	0000 0011	FC6A-PJ2CP
0x09	0000 1001	FC6A-PTS4, FC6A-PTK4
0x0A	0000 1010	FC6A-PN4
0xFF	1111 1111	Not connected

Status List

Status		Description
Hexadecimal	Binary	
0x00	0000 0000	Normal
0x81	1000 0001	Communication error (An error has occurred in the communication between the Touch and a cartridge.)
0x82	1000 0010	Unknown device is detected (The attached cartridge is not recognized by the Touch.)
0x83	1000 0011	Device setting error (No cartridge is attached or the attached cartridge is different from that set in the ladder program or the FBD program.)
0x84	1000 0100	Device writing error (The attempt to set the operation of the cartridge failed.)

Chapter 28 Touch Setup

This chapter describes the Touch setup screen and how to perform setup.

1 Maintenance Screen

1.1 Maintenance Screen Overview

You can display the Maintenance screen in Run Mode. It will allow you to access the System Mode, make Brightness/Contrast adjustment, do Device Monitor, Ladder Monitor, and Start/Stop.

Color LCD models

Maintenance		✕
System Mode	Device Monitor	
Brightness	Ladder Monitor	
Ladder Start/Stop		

Monochrome LCD models

Maintenance		✕
System Mode	Device Monitor	
Brightness/ Contrast	Ladder Monitor	
Ladder Start/Stop		

Maintenance Screen functions are indicated below:

Button	Description
System Mode	In System Mode, you can specify the initial settings and initialize data of the Touch. For details, refer to "2 System Mode Overview" on page 28-3.
Device Monitor	Shows the Device Monitor. This screen can be used to register devices and monitor and change values of devices. For details, refer to Chapter 24 "2.2 Device Monitor" on page 24-19.
Brightness/Contrast	Color LCD models: The control of brightness adjustment of the screen is displayed. Adjusts the brightness of the screen. Monochrome LCD models: The control of brightness and contrast adjustment of the screen is displayed. Adjusts the brightness and contrast of the screen.
Ladder Monitor	Ladder is displayed and allows you to monitor ladder programs. For details, refer to Chapter 24 "2.3 Ladder Monitor" on page 24-23. The Ladder Monitor only operates when ladder program is selected as the programming language for the control function.
Ladder Start/Stop ^{*1} FBD Start/Stop ^{*2}	Manipulates start control (M8000) to run and stop the ladder program or FBD program operation. While the ladder program operation is stopped, "Ladder STOP ^{*1} " or "FBD STOP ^{*2} " flashes at the lower-right corner of the Touch screen.



- If a password has been configured for the project data and press **System Mode**, **Device Monitor** or **Ladder Monitor**, the Enter Password screen will be displayed. Select a user name, and then enter the password. For details, refer to Chapter 21 "User Accounts and the Security Function" on page 21-1.
- When the Stop Input or Reset Input is on, M8000 (Start Control) cannot control the state of the ladder program or FBD program (RUN/STOP).

*1 When ladder program is selected for control function

*2 When FBD program is selected for control function

2 System Mode Overview

The System Mode allows you to access the internal Touch initial settings, self diagnosis, and clearing logged data. In this mode, the project in the Touch will not be running.

2.1 System Mode Screens

In the System Mode, the content of the Top Page appears. (as shown below).

Color LCD models

SYSTEM MODE TOP PAGE		
Run	Main Menu	
2012/JUL/20/FRI 14:30:00 IP Add. 192. 168. 0. 1 (DHCP)		
<<	BRIGHTNESS 31	>>

Monochrome LCD models

SYSTEM MODE TOP PAGE		
Run	Main Menu	
2012/JUL/20/FRI 14:30:00 IP Add. 192. 168. 0. 1 (DHCP)		
<<	CONTRAST 31	>>
<<	BRIGHTNESS 31	>>



For information on accessing the Touch System Mode, refer to "1.2 Displaying the Maintenance Screen" on page 28-2.

The following items are included on the Top Page and Main Menu. When you press the button of an item the operation and settings screen for that item will be displayed.

■ Top Page

Item	Descriptions	See page
Run	Switches to Run Mode.	Page 28-9
Main Menu	Displays the Main Menu.	Page 28-3

■ Main Menu

Item	Descriptions	See page
Initial Setting	Allows adjustment of settings relating to operation, communication parameters, and log data of the Touch.	Page 28-5
Clock Setting	Allows setting of the internal clock of the Touch.	Page 28-9
Run	Switches to Run Mode.	Page 28-9
System Info.	Displays information relating to the type number, project, as well as runtime system of the Touch.	Page 28-9
Top Page	Moves to the Top Page.	Page 28-10
Self Diag.	Executes self diagnosis of memory, the touch panel, display, communication and other self diagnosis.	Page 28-10



The screens under the Top Page in the System Mode are displayed in English only.

2.2 Names and Layout of Setup Menus

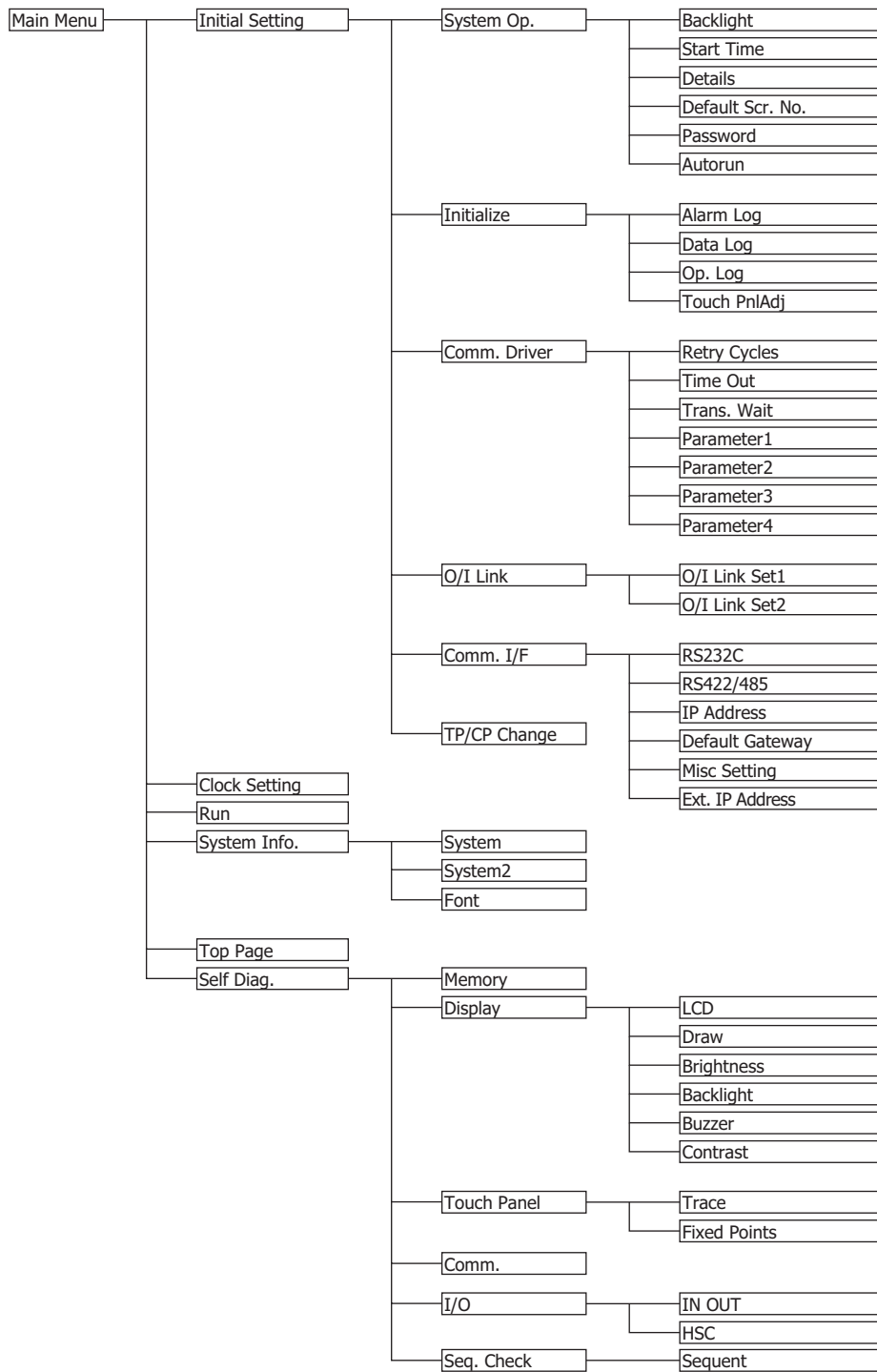

3 Settings

3.1 Initial Setting

Press **Initial Setting** on the Main Menu to display the initial setting screen. You can use this screen to input the settings for Touch operation and communication parameters, and to clear the logs. To return to the Main Menu, press **Main Menu** at the top of the screen.

● System Op. (System Operation)

From the **Main Menu**, press **Initial Setting**, and then **System Op.** to display the system operation menu screen. You can use this screen to set the items below. Press the button for each item to set it.



- To return to the initial settings screen, press **Init Set** at the top of the screen.
- To return to the system operation menu screen from any of the settings screens below, press **System Op.** at the top of the screen.

■ Backlight

This item sets the amount of time (in minutes) until the backlight turns off automatically when the screen is not touched or switched for a preset amount of time.

From the Main Menu, press **Initial Setting**, **System Op.**, and then **Backlight**.

To set a value, enter the value using the Keypad, and then press **ENT**.

Press **CAN** to cancel the entered value and display the currently set value.



- The setting is not updated if you display another screen before pressing **ENT**.
- Setting a time of 0 turns off the backlight automatically.

■ Start Time

This item sets the amount of time (in minutes) until communication with the external device starts after Touch power ON. This can be used to synchronize boot times with the external device.

From the main menu, press **Initial Setting**, **System Op.**, and then **Start Time**.

To set a value, enter the value using the Keypad, and then press **ENT**.

Press **CAN** to cancel the entered value and display the currently set value.



The setting is not updated if you display another screen before applying the setting.

■ Details (Detailed Settings)

The following items can be set.

- Whether or not to have a sound made when a touch switch is pressed.
- Select the screen number to be displayed as a binary number or BCD (binary coded decimal).
- To set blink cycle.
- Display the error message in Japanese or English.

From the Main Menu, press **Initial Setting, System Op.**, and then **Details**.

Select the item to change using **▲** or **▼**. The selected item is highlighted.

Each press of **CHG** changes the property of the selected item. Repeat this procedure until the desired properties are displayed.

Press **ENT** to apply the changes.



The setting is not updated if you display another screen before applying the setting.

■ Default Scr. No. (Default Screen Number)

This item sets the No. (as a decimal value) of the screen to display after power ON.

From the main menu, press **Initial Setting, System Op.**, and then **Default Scr. No.**

To set a value, use the keypad to enter a value.

Press **ENT** on the keypad to apply the value entered.

Press **CAN** to cancel the entered value and display the currently set value.



- The setting is not updated if you display another screen before applying the setting.
- If the Default Scr. No. is set to 0, Touch will display the screen set in the external device instead of the Default Screen. For details, refer to Chapter 3 "System Area 1" on page 3-23.

■ Password

Specifies a password to use to move to System Mode. This changes the password for the "Administrator" Security Group of the WindO/I-NV3.

From the Main Menu, press **Initial Setting, System Op.**, and then **Password**.

Press **Change Password** to display the password input screen.

To enter a password, use the arrow keys (**↑**, **↓**, **←**, **→**), to move the cursor to a selected character and then press **ENT**.

Once the the password is entered, move the cursor to **OK**, and then press **ENT** to confirm the password entered. To cancel changing the password, move the cursor to **CAN**, and then press **ENT**.

To clear the password input field, move the cursor to **CLR**, and then press **ENT**.



- If you want to return to the password screen and decide not to change the password, move the cursor to the **CAN** and press **ENT** on the password input screen.
- Pressing **ENT** without entering a password disables the password function.



- When you do not assign a password to a project data, the Password is blank.
- If you forget your password, contact for sales representative.

■ Autorun

You have the option to enable or disable the USB Autorun function.

When Autorun is enabled, Autorun function will be executed when a USB flash drive is inserted to the Touch.

From the Main Menu, press **Initial Setting, System Op.**, and then **Autorun**.



The setting is not updated if you display another screen before applying the setting.

● Initialize

From the Main Menu, press **Initial Setting**, and then **Initialize** to display the initialization menu screen. You can use this screen to set the following items. Press the button for each item to set it.



- To return to the initial settings screen, press **Init Set** at the top of the screen.
- To return to the initialization menu screen from any of the settings screens below, press **Init** at the top of the screen.

■ Alarm Log

Clears all the Alarm Log data.

From the Main Menu, press **Initial Setting**, **Initialize**, and then **Alarm Log**. Press **Yes** to clear the Alarm Log data.

■ Data Log

Clears all the Data Log data.

From the Main Menu, press **Initial Setting**, **Initialize**, and then **Data Log**. Press **Yes** to clear the Data Log data.

■ Op. Log (Operation Log)

Clears all the Operation Log data.

From the Main Menu, press **Initial Setting**, **Initialize**, and then **Op. Log**. Press **Yes** to clear the Operation Log data.

■ Touch PnlAdj (Touch Panel Adjust)

Adjusts the analog touch panel.

From the Main Menu, press **Initial Setting**, **Initialize**, and then **Touch PnlAdj**. Press **Yes** and adjust according to the instructions on the screen.

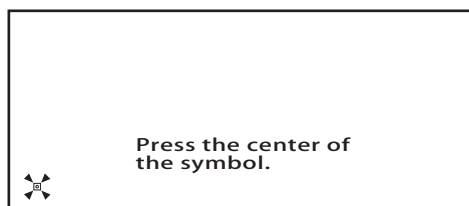

Press the center of  displayed on the screen, in the following order: lower-left corner, lower-right corner, upper-left corner, upper-right corner of the Touch screen. The position of the analog touch panel is properly adjusted and set.

● Comm. Driver (Communication Driver)

From the Main Menu, press **Initial Setting**, and then **Comm. Driver** to display the communication driver menu screen.

To specify settings, press the button to select a choice. Comm. Driver setting items vary based on the currently connected hardware. For details about settings, refer to the "External Device Setup Manual".

If **No External Devices** are selected from the **Communication Driver**, some settings cannot be modified.



To return to the initial settings screen, press **Init Set** at the top of the screen.

● O/I Link

From the Main Menu, press **Initial Setting**, and then **O/I Link** to display the O/I link menu screen.

This screen displays information on the O/I Link.

(Various settings can be made by pressing **O/I Link Set 1** and **O/I Link Set 2**.)



- To return to the initial settings screen, press **Init Set** at the top of the screen.
- For details about settings, refer to the "External Device Setup Manual".

● Comm. I/F (Communication Interface)

From the Main Menu, press **Initial Setting**, and then **Comm. I/F** to display the communication interface settings menu screen.

You can use this screen to set the items below. Press the button for each item to set.



- To return to the initial settings screen, press **Init Set** at the top of the screen.
- Press **Comm. I/F** at the top of the screen to return to the communication interface settings menu screen.

■ RS232C

Allows the setting of communication parameters for the Serial Interface Port (RS232C).

From the Main Menu, press **Initial Setting**, **Comm. I/F**, and then **RS232C**.

■ RS422/485

Allows the setting of communication parameters for the Serial Interface Port (RS422/485).

From the Main Menu, press **Initial Setting**, **Comm. I/F**, and then **RS422/485**.

■ IP Address

Allows the setting of the IP address and subnet mask.

From the Main Menu, press **Initial Setting**, **Comm. I/F**, and then **IP Address**.

Press <-- or --> to select an item, and then use the Keypad to enter the IP address and subnet mask values.

Press **ENT** to apply the entered values.



The setting is not updated if you display another screen before applying the setting.

■ Default Gateway

Specify the default gateway.

From the Main Menu, press **Initial Setting**, **Comm. I/F**, and then **Default Gateway**.

Press <-- or --> to select an item, and then use the Keypad to enter the default gateway value. Press **ENT** to apply the entered value.



The setting is not updated if you display another screen before applying the setting.

■ Misc Setting (Miscellaneous Setting)

Specify whether to allow or prohibit Maintenance Communication via TCP/IP (refer to Chapter 23 "Using the online function for Ethernet communication" on page 23-7).

From the Main Menu, press **Initial Setting**, **Comm. I/F**, and then **Misc Setting**.

Each press of **CHG** changes the property of the selected item. Repeat this procedure until the desired properties are displayed.

Press **ENT** to apply the entered value.



The setting is not updated if you display another screen before applying the setting.

■ Ext. IP Address (External Device IP Address)

Changes the IP addresses for the external device.

From the Main Menu, press **Initial Setting**, **Comm. I/F**, and then **Ext. IP Address**.

Procedure

- 1 Press <-- or --> to select the station number, and then enter the station number value with the numeric keypad.
- 2 Press **ENT** to confirm the entered value. The IP address for the selected station number is displayed.
- 3 Press <-- or --> to select the item, and then enter the IP address with the numeric keypad.
- 4 Press **ENT** to confirm the entered value.
- 5 Press **SAVE** to save the settings.



If you switch to another screen or change the station number before pressing **SAVE**, the settings are not saved.

- **TP/CP Change** (Change the Timer and counter preset value)
Saves the control device timer and counter preset values.
From the Main Menu, press **Initial Setting**, and then **TP/CP Change**.
If you press **SAVE**, the modified values are saved and the project data is updated.
If you press **CLEAR**, the modified values are restored to the values configured in the project data.

3.2 Clock Setting

Press **Clock Setting** in the Main Menu to display the clock settings screen.
Use this screen to set the internal clock of the Touch.
To return to the Main Menu, press **Main Menu** at the top of the screen.

Procedure

- 1 Press <-- or --> to select an item and then the date or time with the numerical keypad.
- 2 Press **ENT** to apply the new setting.
- 3 Press **SAVE** to save the date/time setting.



The setting is not updated if you display another screen before applying the setting.

3.3 Run

Switches to the Run Mode to execute the project.

3.4 System Info. (System Information)

From the Main Menu, press **System Info.**, and then press **System** or **System 2** to display the system information screen.
This screen displays information such as the Touch type number, the type and version number of runtime system.
To return to the Main Menu, press **Main Menu** at the top of the screen.



Only the first 15 characters of the project name are displayed.

- **System**
From the Main Menu, press **System Info.** and then **System**.
Displays the following settings:
 - Touch type number
 - MAC address
 - Boot software version
 - Runtime system version
 To return to the system information screen, press **System Info.** at the top of the screen.
- **System 2**
From the main menu, press **System Info.** and then **System 2**.
Displays the following settings:
 - Project file name
 - External device manufacturer
 - Communication protocol
 - Communication driver version
 To return to the system information screen, press **System Info.** at the top of the screen.
- **Font**
From the Main Menu, press **System Info.**, and then **Font**.
Displays the font type stored in Touch.
To return to the system information screen, press **System Info.** at the top of the screen.

3.5 Top Page

Press **Top Page** in the Main Menu to return to the Top Page.

3.6 Self Diag. (Self Diagnosis)

From the Main Menu, press **Self Diag.** to display the self-diagnosis screen.

Use this screen to run Touch internal self-diagnosis. To execute an operation, press the corresponding button.

To return to the Main Menu, press **Main Menu** at the top of the screen.









- You need inspection jigs to run self-diagnosis.
- Self Diagnosis is a special screen for factory inspections. Do not use without due reason.

Chapter 29 SmartAXIS Specifications

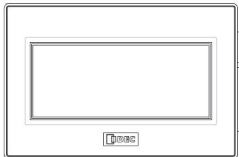
1 Touch

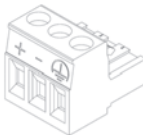
1.1 Packing Contents

Before installing the Touch, make sure that the specifications of the product conform to your requirements, and that no parts are missing or damaged due to accidents during transportation.

Name	Pcs/pack	
Touch Unit	1	
Instruction Sheet	1	
Mounting clips	2	
Power plug (Attached to the Touch)	1	
Communication I/F plug (Attached to the Touch)	1	
USB Cable Lock Pin	2	
USB Clamp Band	2	

1.2 Type Number

LCD size	I/O configuration	Bezel color	Type No.
3.7inch STN Monochrome LCD	Digital sink in: 6pt Shared digital sink in/analog in: 2pt Relay out: 4pt	Light gray	FT1A-M12RA-W
		Dark gray	FT1A-M12RA-B
		Silver	FT1A-M12RA-S
	Digital source in: 6pt Shared digital sink in/analog in: 2pt Transistor sink out: 4pt Analog out: 2pt	Light gray	FT1A-M14KA-W
		Dark gray	FT1A-M14KA-B
		Silver	FT1A-M14KA-S
	Digital sink in: 6pt Shared digital sink in/analog in: 2pt Transistor source out: 4pt Analog out: 2pt	Light gray	FT1A-M14SA-W
		Dark gray	FT1A-M14SA-B
		Silver	FT1A-M14SA-S
3.8inch TFT Color LCD	Digital sink in: 6pt Shared digital sink in/analog in: 2pt Relay out: 4pt	Light gray	FT1A-C12RA-W
		Dark gray	FT1A-C12RA-B
		Silver	FT1A-C12RA-S
	Digital source in: 6pt Shared digital sink in/analog in: 2pt Transistor sink out: 4pt Analog out: 2pt	Light gray	FT1A-C14KA-W
		Dark gray	FT1A-C14KA-B
		Silver	FT1A-C14KA-S
	Digital sink in: 6pt Shared digital sink in/analog in: 2pt Transistor source out: 4pt Analog out: 2pt	Light gray	FT1A-C14SA-W
		Dark gray	FT1A-C14SA-B
		Silver	FT1A-C14SA-S

1.3 Part Names

■ FT1A-*12RA

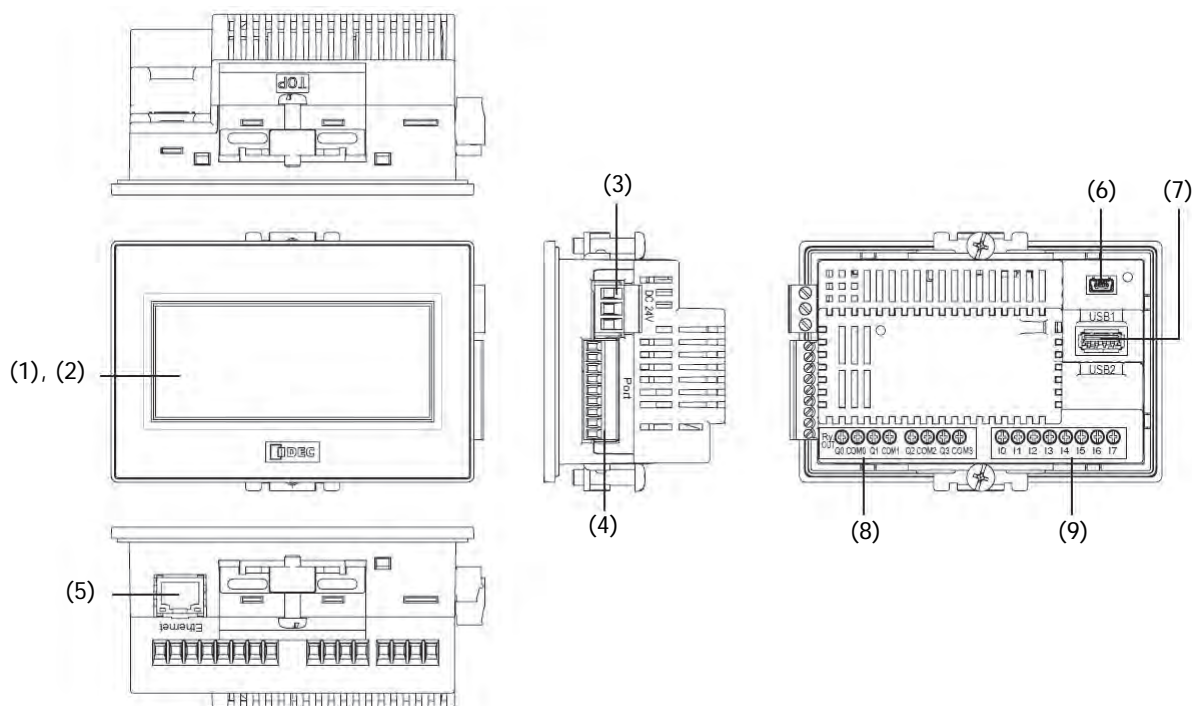

No.	Name	Description
(1)	Display	
(2)	Touch Panel	
(3)	Power Supply Terminal	Connector : Terminal Block 3 pin
(4)	Serial Interface (Port)	RS232C, RS422/485 Connector : Terminal Block 9 pin
(5)	Ethernet Interface (Ethernet)	IEEE802.3u 10BASE-T/100BASE-TX Connector : RJ-45
(6)	USB Interface (USB1)	USB2.0 (Device) Connector : Mini-B
(7)	USB Interface (USB2)	USB1.1 (External device) Connector : Type A
(8)	Output Terminal (Q0 to Q3)	Relay output (10A)
(9)	Input Terminal (I0 to I7)	Digital input, Analog input

■ FT1A-*14KA/14SA

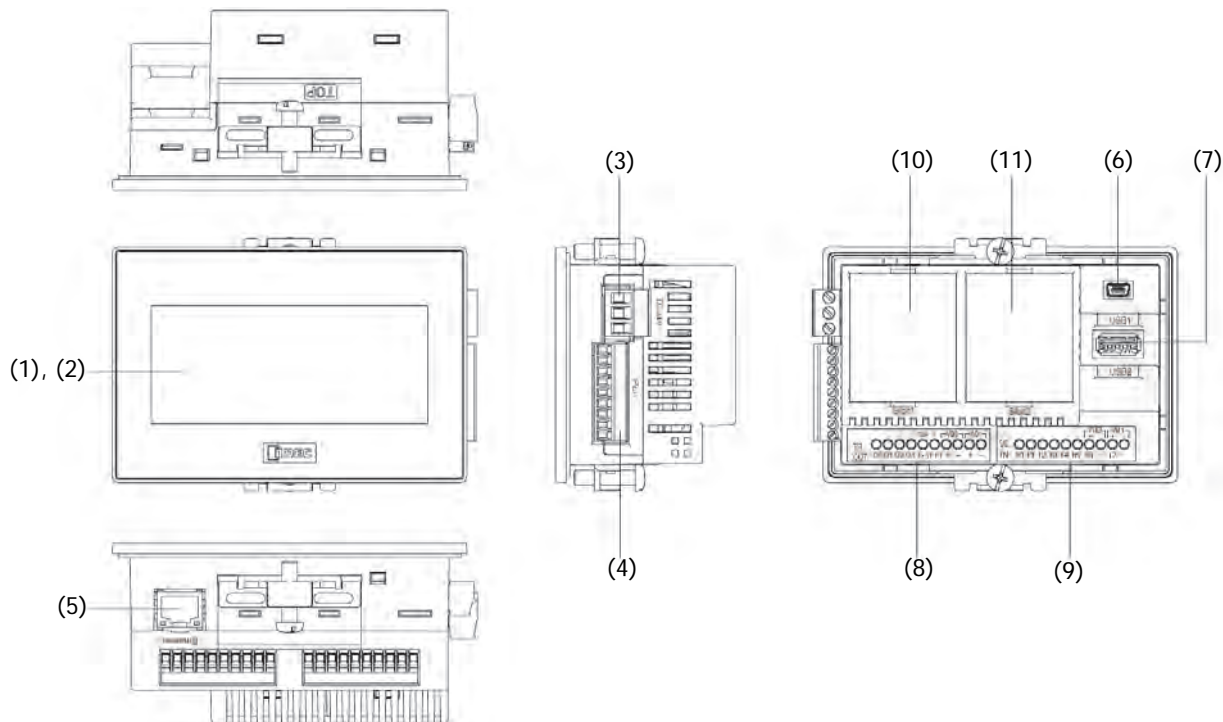

No.	Name	Description
(1)	Display	
(2)	Touch Panel	
(3)	Power Supply Terminal	Connector : Terminal Block 3 pin
(4)	Serial Interface (Port)	RS232C, RS422/485 Connector : Terminal Block 9 pin
(5)	Ethernet Interface (Ethernet)	IEEE802.3u 10BASE-T/100BASE-TX Connector : RJ-45
(6)	USB Interface (USB1)	USB2.0 (Device) Connector : Mini-B
(7)	USB Interface (USB2)	USB1.1 (External device) Connector : Type A
(8)	Output Terminal (Q0 to Q3, AQ0 to AQ1)	Transistor output, analog output
(9)	Input Terminal (I0 to I7)	Digital input, Analog input
(10)	Slot 1	Optional product (analog cartridge) expansion •FC6A-PJ2A •FC6A-PK2AV •FC6A-PK2AW •FC6A-PJ2CP
(11)	Slot 2	Optional product (analog cartridge) expansion •FC6A-PJ2A •FC6A-PK2AV •FC6A-PK2AW •FC6A-PJ2CP

1.4 External Interfaces

CAUTION

- Make sure to turn off the power to the Touch before wiring each interface.
- Do not touch the terminals during communication. Doing so may result in electrical shock.
- When keeping power ON, terminals connected to external devices may reach high temperatures. Do not touch the terminals immediately after turning the power off.
- Do not touch the terminals immediately after turning the power off. Doing so may result in electrical shock.
- Insert and crimp the wire to the end portion of the ferrule.
- Always use ferrules when wiring stranded wire and multiple wires to the terminal block. Otherwise there is a risk of wires becoming disconnected.

● Serial Interface (Port)

Interface Specification	RS232C, RS422/485
Connector	Detachable Terminal Block 9 pin
Applicable cable	RS232C: AWG16 to AWG28 RS422/485: AWG16 to AWG28 Shielded twisted-pair Stripped wire length 7 mm (Solid wire)
Recommended ferrule	AI 0.34-8 TQ (For AWG22, For 1 wire) AI 0.5-8 WH (For AWG20, For 1 wire) AI-TWIN2 x 0.5-8 WH (For AWG20, For 2 wires) (Phoenix Contact)
Tightening Torque	0.25 N•m (Screwdriver SZS 0.4 x 2.5, Phoenix Contact)



No.	Name	I/O	Function	Communication type	
1	SD	OUT	Send Data	RS232C	/
2	RD	IN	Receive Data		
3	RS	OUT	Request to Send		
4	CS	IN	Clear to Send		
5	SG	—	Signal Ground	/	RS422/485
6	SDA	OUT	Send Data (+)		
7	SDB	OUT	Send Data (-)		
8	RDA	IN	Receive Data (+)		
9	RDB	IN	Receive Data (-)		



The Touch is not equipped with terminating resistance. When using the RS422/485 interface, insert terminating resistance with the appropriate value (around 100 to 120 Ω) between terminal No. 8 (RDA) and terminal No. 9 (RDB) as required.

● I/O Terminals

■ FT1A-*12RA

Applicable cable	AWG16 to AWG22 Stripped wire length 6.5 mm, coating diameter ϕ 3.4 mm or lower (Solid wire)
Recommended ferrule	AI 0.34-8 TQ (For AWG22, For 1 wire) AI 0.5-8 WH (For AWG20, For 1 wire) AI 0.75-8 GY (For AWG18, For 1 wire) AI 1-10 RD (For AWG18, For 1 wire) AI 1.5-10 BK (For AWG16, For 1 wire) AI TWIN 2 x 0.75 10GY (For AWG18, For 2 wires) (Phoenix Contact)
Tightening Torque	0.5 to 0.6 N•m (Screwdriver SZS 0.6 x 3.5, Phoenix Contact)

■ FT1A-*14KA/14SA

Applicable cable	AWG20 to AWG22 Stripped wire length 5 mm, coating diameter ϕ 2.6 mm or lower (Solid wire)
Recommended ferrule	AI 0.34-8 TQ (For AWG22, For 1 wire) AI 0.5-8 WH (For AWG20, For 1 wire) AI-TWIN2 x 0.5-8 WH (For AWG20, For 2 wires) (Phoenix Contact)
Tightening Torque	0.2 N•m (Screwdriver SZS 0.4 x 2.5, Phoenix Contact)

Terminal Arrangement

Terminal Arrangement and I/O Wiring Diagrams

■ FT1A-*12RA

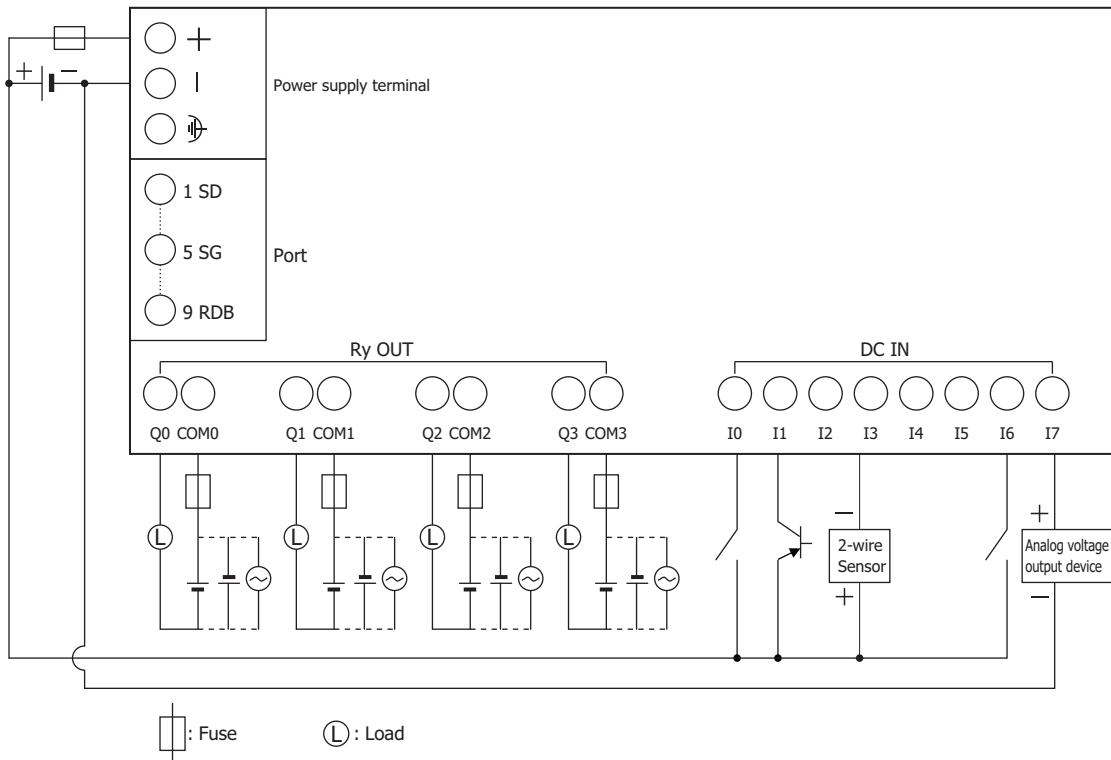

■ FT1A-*14KA

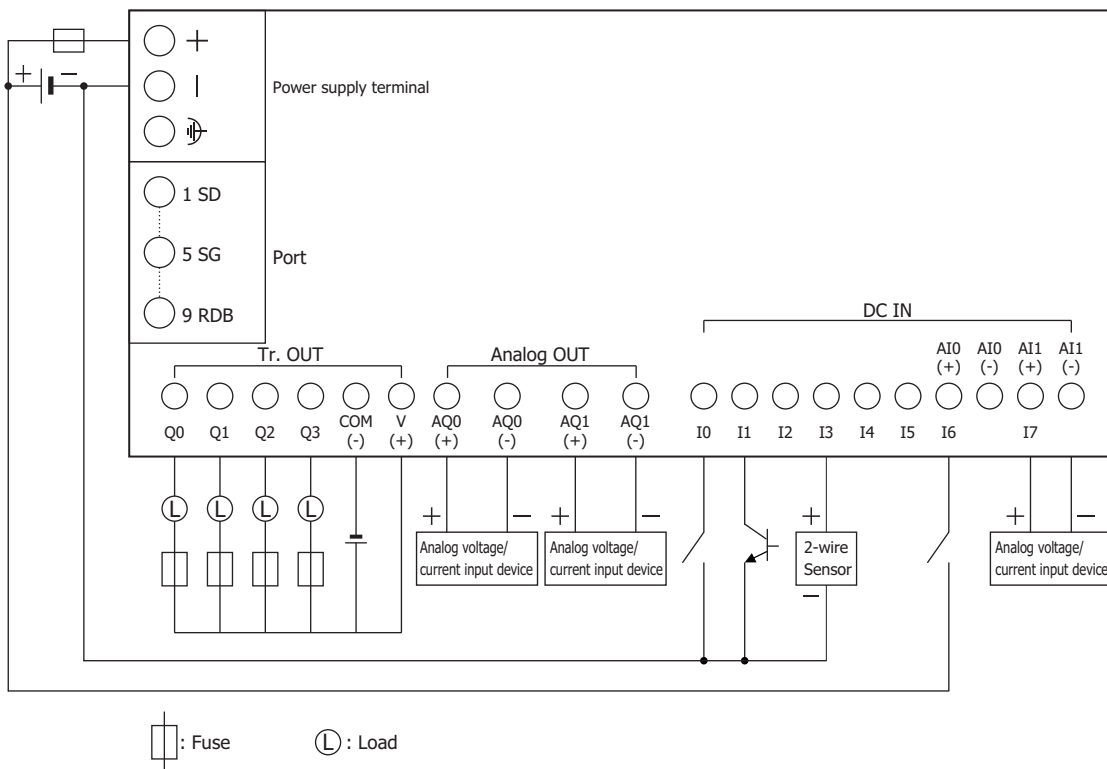

■ FT1A-*14SA

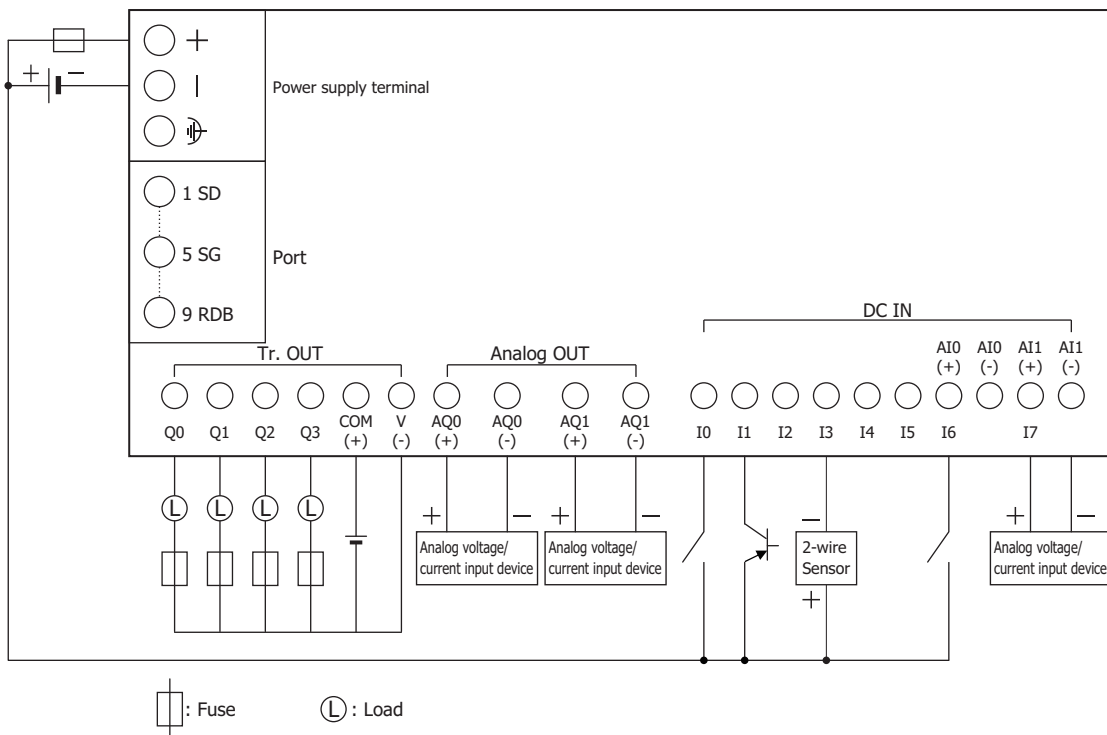

● Input Terminal Specifications

Input Points	8
Rated Input Voltage	24V DC
Input Voltage Range	0 to 28.8V DC
Effect of Improper Input Connection	No damage. (If any input exceeding the rated value is applied, permanent damage may be caused.)

Digital Input Specifications

Input Type		Sink (FT1A-*12RA/14SA) Source (FT1A-*14KA)
Input Points (Terminal No. /Common Line Name)		6 points in 1 common line (I0 to I5/Power supply "-" terminal)
Rated Input Current		4.4mA (Sink Input) 5.2mA (Source Input)
Input Impedance		5.5k Ω (Sink Input) 4.7k Ω (Source Input)
Input System Transfer Time	OFF \rightarrow ON	2.5 μ s + filter value
	ON \rightarrow OFF	5 μ s + filter value
Isolation	Between input terminals	Not isolated
	Internal circuit	Not isolated
Input Type		Type1 (IEC61131-2)
External Load for I/O Interconnection		Not needed
Signal Determination Method		Static
Cable Length (in compliance with EMC standards)		3m

Analog Input Specifications

■ FT1A-*12RA

Input Signal Type		Voltage Input
Input Points (Terminal No. /Common Line Name)		2 points in 1 common line (I6, I7/internal -terminal, SG terminal for Port)
Input Range		0 to 10V DC
Rated Input Current		0.3mA
Input Impedance		78.0K Ω
Digital Resolution		0 to 1,000 (850 steps)
Data Type		Binary data: 0 to 1000
Input Value of LSB ^{*1}		11.7mV
Type of Input		Single-ended input
AD Conversion	Sample Duration Time	2 msec max.
	Sample Repetition Time	2 msec max.
	Total Input System Transfer Time	3 msec + filtering time + scan time
Input Error	Maximum Error at 25°C	\pm 3.0% of full scale
	Temperature Coefficient	\pm 0.04% of full scale/°C
	Maximum Error	\pm 5.0% of full scale
General Characteristics	Operating Mode	Self-scan
	Conversion Method	$\Sigma\Delta$ type
Status Display		Device Monitor screen (LCD)
Maximum Temporary Error during Electrical Noise Tests		\pm 5.0% of full scale
Recommended Cable for Noise Immunity		Twisted pair shielded cable

*1 This value may vary by device.

Calibration or Verification to Maintain Rated Accuracy		Not possible
Maximum Permanent Allowed Overload (No Damage)		28.8V DC
Overload Status (Outside Input Range) Detection		Detectable
Isolation	Between input terminals	Not isolated
	Between input and internal circuit	Not isolated
Used as Digital Input	Digital Input Type	— (IEC 61131-2 digital input type is not supported)
	Input Threshold	ON voltage: 15V min. (ON current: 0.20 mA min.)
		OFF voltage: 5V max. (OFF current: 0.06 mA max.)

■ FT1A-*14KA/14SA

Input Signal Type		Voltage/current input (selectable with software)
Input Points (Terminal No. /Common Line Name)		1 point in 1 common line AI0+, AI1+ / AI0-, AI1-
Input Range		0 to 10V DC (Voltage Input) 4 to 20mA (Current Input)
Input Impedance		78.0K Ω (Voltage Input) 250 Ω (Current Input)
Digital Resolution		0 to 1,000 (850 steps)
Data Type		Binary data: 0 to 1000
Input Value of LSB*1		11.7mV (Voltage Input) 16 μ A (Current Input)
Type of Input		Single-ended input
AD Conversion	Sample Duration Time	2 msec max.
	Sample Repetition Time	2 msec max.
	Total Input System Transfer Time	3 msec + filtering time + scan time (Voltage Input) 12 msec + filtering time + scan time (Current Input)
Input Error	Maximum Error at 25°C	\pm 3.0% of full scale
	Temperature Coefficient	\pm 0.04%/°C of full scale
	Maximum Error	\pm 5.0% of full scale
General Characteristics	Operating Mode	Self-scan
	Conversion Method	SAR
Status Display		Device Monitor screen (LCD)
Maximum Temporary Error during Electrical Noise Tests		\pm 5.0% of full scale
Recommended Cable for Noise Immunity		Twisted pair shielded cable
Calibration or Verification to Maintain Rated Accuracy		Not possible
Maximum Permanent Allowed Overload (No Damage)		28.8V DC (Voltage Input) 40mA (Current Input)
Overload Status (Outside Input Range) Detection		Detectable
Isolation	Between input terminals	Not isolated
	Between input and internal circuit	Not isolated
Used as Digital Input	Digital Input Type	— (IEC 61131-2 digital input type is not supported)
	Input Threshold	ON voltage: 15V min. (ON current: 0.20 mA min.)
		OFF voltage: 5V max. (OFF current: 0.06 mA max.)

*1 This value may vary by device.

Equivalent Circuit

■ **FT1A-*12RA**

Sink Input (I0 to I5)

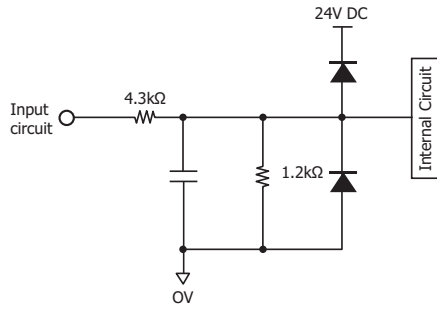

Shared Digital/Analog Input (I6, I7)

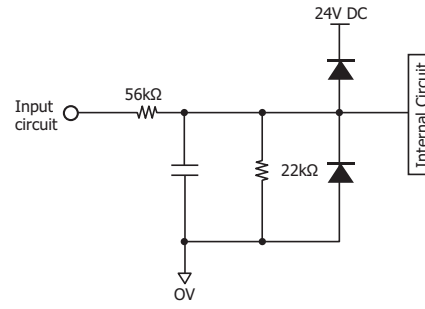

■ **FT1A-*14KA**

Source Input (I0 to I5)

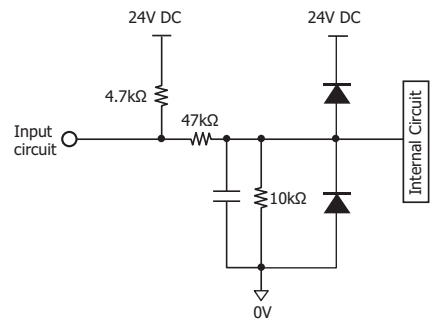

Shared Digital/Analog Input (I6, I7)

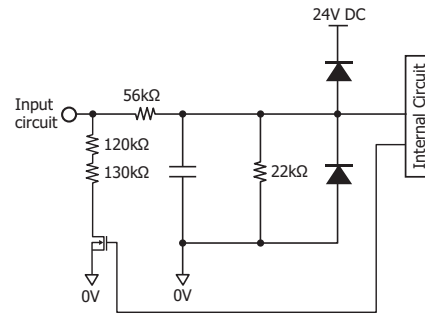

■ **FT1A-*14SA**

Sink Input (I0 to I5)

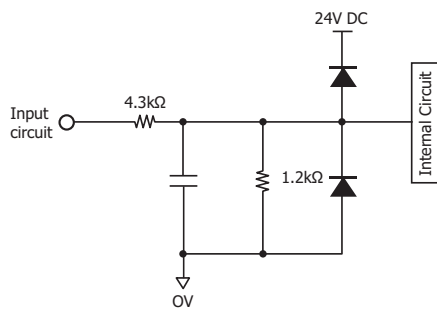

Shared Digital/Analog Input (I6, I7)

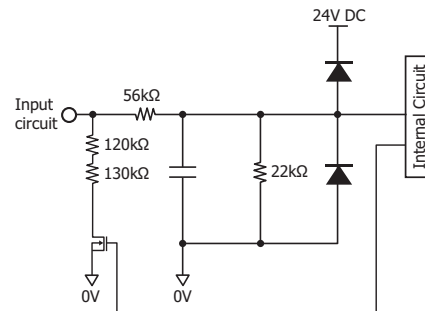

Operating Range

Sink Input (I0 to I5)

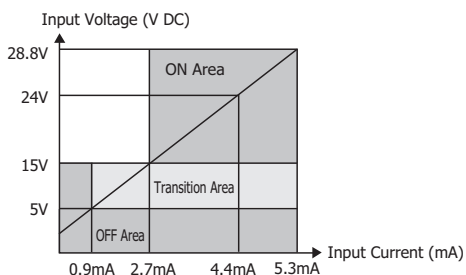

Source Input

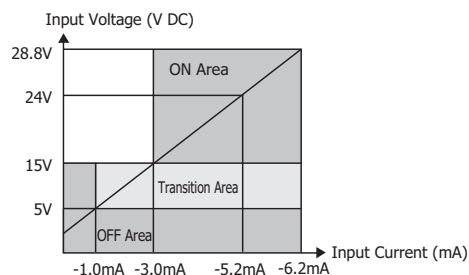

Shared Digital/Analog Input (I6, I7)

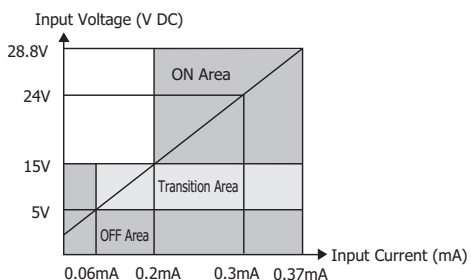

● Output Specifications

Relay Output Specifications

■ FT1A-*12RA

No. of Outputs (Terminal No.)		4 (Q0 to Q3)
Output Type		1a contact
Maximum Load Current		10A
Minimum Switching Load		10 mA/5V DC (reference value)
Initial Contact Resistance		100 mΩ max. (1A, 6V DC)
Electrical Life		100,000 operations min. (rated load 1,800 operations/hour)
Mechanical Life		20,000,000 operations min. (no load 18,000 operations/hour)
Rated Load		250V AC/10A, 30V DC/10A
Dielectric Strength	Between output terminal and internal circuit	2,300V AC 5mA, 1 minute
	Between output terminals (COMs)	
Status Display		Device Monitor screen (LCD display)

Output Delay

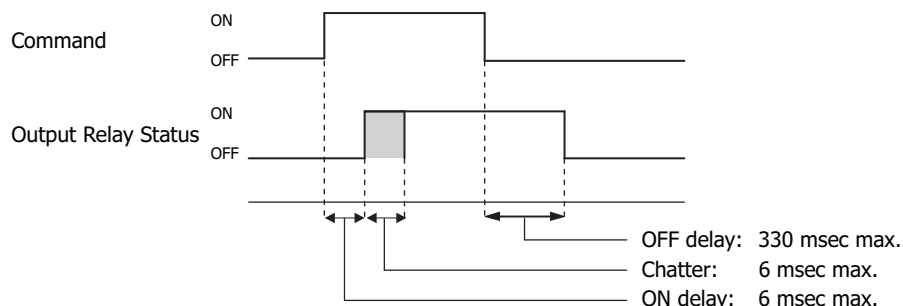

Transistor Output Specifications

■ FT1A-*14KA/SA

No. of Outputs (Terminal No.)	4 (Q0 to Q3)
Output Type	Sink output (FT1A-*14KA) Source output (FT1A-*14SA)
Rated Load	24V DC
Operating Load Voltage Range	20.4 to 28.8V DC
Maximum Load Current	0.3A
Voltage Drop (ON voltage)	1V max. (Voltage between COM and output terminal when ON)
Maximum Inrush Current	1A
Leakage Current	0.1 mA max.
Clamping Voltage	39V \pm 1V
Maximum Lamp Load	8W
Inductive Load	L/R=10 ms (28.8V DC, 1 Hz)
External Current Draw	100 mA max., 24V DC Sink output: power voltage at the +V terminal Source output: power voltage at the +COM terminal
Isolation	Photocoupler isolated
Status Display	Device Monitor screen (LCD display)

Equivalent Circuit

■ FT1A-*14KA/SA

Sink Output (Q0 to Q3)

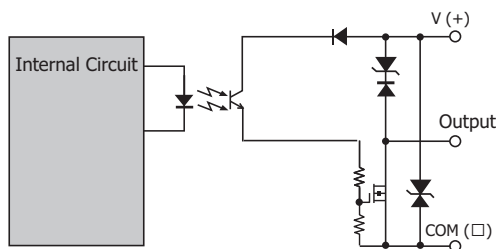

Source Output (Q0 to Q3)

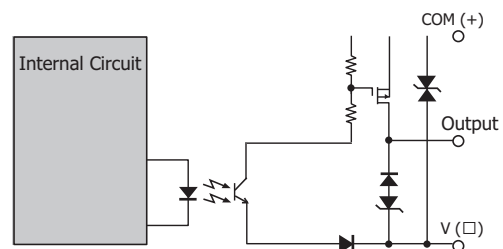

Analog Output Specifications■ **FT1A-*14KA/SA**

No. of Outputs (Terminal No.)		2 (AQ0 to AQ1)
Output Type		Voltage/current output
Output Range		0 to 10 V (Voltage output) 4 to 20 mA (Current output)
Output Load	Impedance	2 k Ω min. (Voltage output) 500 Ω max. (Current output)
	Load Type	Resistance load
Digital Resolution		0 to 1,000 (10bit)
Output Value of LSB		10 mV (Voltage output) 16 μ A (Current output)
Data Type		Binary data: 0 to 1000
Monotonicity		Yes
Output Error	Maximum Error at 25°C	\pm 0.3% of full scale
	Temperature Coefficient	\pm 0.02%/°C of full Scale
	Reproducibility After Stabilization Time	\pm 0.4% of full scale
	Non-linearity	\pm 0.01% of full scale
	Output Ripple	30 mV max.
	Overshoot	0% ^{*1}
	Maximum Error	\pm 1.0% of full scale
Open Current Loop		Cannot be detected

*1 Overshoot may occur at light loads.

The occurrence of overshoot can be controlled by inserting damping resistance into the circuit. A general guide for the damping resistance value is about 150 Ω including the input line impedance for the destination.

1.5 Specifications

■ Applicable Standards

Safety Standard	UL508 CSA C22.2 No.142 (c-UL)
EMC Standard ^{*1}	IEC/EN 61131-2:2007

■ Environmental Specifications

Operating Temperature	0 to 55°C: FT1A-M (Monochrome LCD models) ^{*2} (No freezing) -20 to 55°C: FT1A-C (Color LCD models) ^{*2} (No freezing)
Relative Humidity	10 to 95% RH (No condensation)
Storage Temperature	-20 to +60°C (No freezing)
Storage Humidity	10 to 95% RH (No condensation)
Altitude	Operation: 0 to 2,000m Transport: 0 to 3,000m
Pollution Degree	2
Corrosion Immunity	Free from corrosive gases

■ Electrical Specifications

FT1A-*12RA

Rated Voltage	24V DC
Power Consumption	9.2W max. When USB2 is unused: 5.8W max.
Power Voltage Range	20.4 to 28.8V DC
Allowable Momentary Power Interruption	10 msec max.
Inrush Current	50A max.
Dielectric Strength	Between power and FE terminals: 500V AC, 5mA, 1 minute Between power and output terminals: 2,300V AC, 5mA, 1 minute

FT1A-*14KA/SA

Rated Voltage	24V DC
Power Consumption	10.1W max. When USB2 is unused: 8.1W max.
Power Voltage Range	20.4 to 28.8V DC
Allowable Momentary Power Interruption	11 msec max.
Inrush Current	50A max.
Dielectric Strength	Between power and FE terminals: 500V AC, 5mA, 1 minute Between power and output terminals: 500V AC, 5mA, 1 minute

■ Construction Specifications

Vibration Resistance	5 to 8.4Hz amplitude 3.5mm, 8.4 to 150Hz acceleration 9.8m/s ² 10 times on each of three mutually perpendicular axes (100 minutes) (IEC61131-2)
Shock Resistance	147m/s ² , 11ms (5 shocks on each of three mutually perpendicular axes) (IEC61131-2)

*1 When using the Touch as the EMC Standard Approved Products, attach a ferrite core (ZCAT3035-1330 manufactured by TDK Corporation) to the power cables and the communication cables.

If there a risk of an error occurring due to noise, install the product separated from sources of noise such as power lines, high voltage lines, and load lines. Also attach a ferrite core to the I/O cable (ZCAT3035-1330 manufactured by TDK Corporation).

*2 FT1A-*12RA-*: The UL and c-UL certified operating temperature is 0 to 50°C.

■ Performance Specifications

Type Number	FT1A-M (Monochrome LCD models)	FT1A-C (Color LCD models)	
Display	LCD Type	STN Monochrome LCD	TFT Color LCD
	Display Colors	2 Colors (Black, White) 8 shades	65,536 Colors
	Effective Display Area [mm]	87.59(W) × 35.49 (H)	88.92 (W) × 37.05 (H)
	Display Resolution	240 (W) x 100 (H) pixels	
	View angle	Left/Right/Top/Bottom: 45°	Left/Right: 40°, Top: 20°, Bottom: 60°
	Contrast Adjustment	32 levels	–
	Brightness of LCD only	White: 740 [cd/m ²] Red: 135 [cd/m ²]	400 [cd/m ²]
	Brightness Adjustment	32 levels	
	Backlight	LED (White, Red) Screen color: White, Pink, Red	LED (White)
	Backlight Life ^{*2}	50,000 hours nominal	
Touch Panel	Switch Type	Analog Resistive Film	
	Operating Force	0.2 to 2.5 N	
	Multiple Operations	Impossible	
	Life	1,000,000 operations	
User Memory	5MB		
Backup Battery ^{*3}	Lithium secondary battery Backup Duration: Approx. 30 days (typical) (Operating temperature: 25°C) Charging Time: Approx. 15 hours for charging from 0% to 90% of full charge Battery Life: 5 years in cycles of 9-hour charging and 15-hour discharging Replaceability: Not possible to replace battery		
Backup Data	128KB		
Buzzer Output	Single tone (tone length is adjustable)		
Degree of Protection	IP66F (IEC60529) ^{*4}		
Weight (approx.)	FT1A-*12RA: 300 g FT1A-*14KA/SA: 250 g		

■ EMC Specifications

Type Number	FT1A-*12RA	FT1A-*14KA/SA
Radiated Emission	Class A : 10m 40dBμV/m quasi-peak (30M to 230MHz) 47dBμV/m quasi-peak (230M to 1GHz)	
Electrostatic Discharge	Contact : ±6kV Air : ±8kV	
Electromagnetic Field	10V/m (80 to 1000 MHz) 3V/m (1.4 to 2.0 GHz) 1V/m (2.0 to 2.7 GHz) 80% AM (1kHz)	
Fast Transient Burst	±2kV (Power, Output terminal) ±1kV (Port, Ethernet, Input terminal)	±2kV (Power) ±1kV (Port, Ethernet, Input terminal, Output terminal)
Surge Immunity	±500V (between +24V-0V) ±1kV (between +24V-FE, 0V-FE)	
Conducted Radio Frequency Immunity	10V (Power, Port, Ethernet, Input terminal, Output terminal) (150kHz to 80MHz) 80% AM (1kHz)	

*2 The backlight life refers to the time until the surface brightness reduces to a half after using continuously at room temperatures.

*3 In high temperature environments battery life may be affected, so retention time may be reduced.

*4 The degree of protection for the operating section after the panel is attached. The compliance test has been passed, but this is not a guarantee of operation in all environments.

1.6 Dimensions

■ FT1A-*12RA

Unit: mm

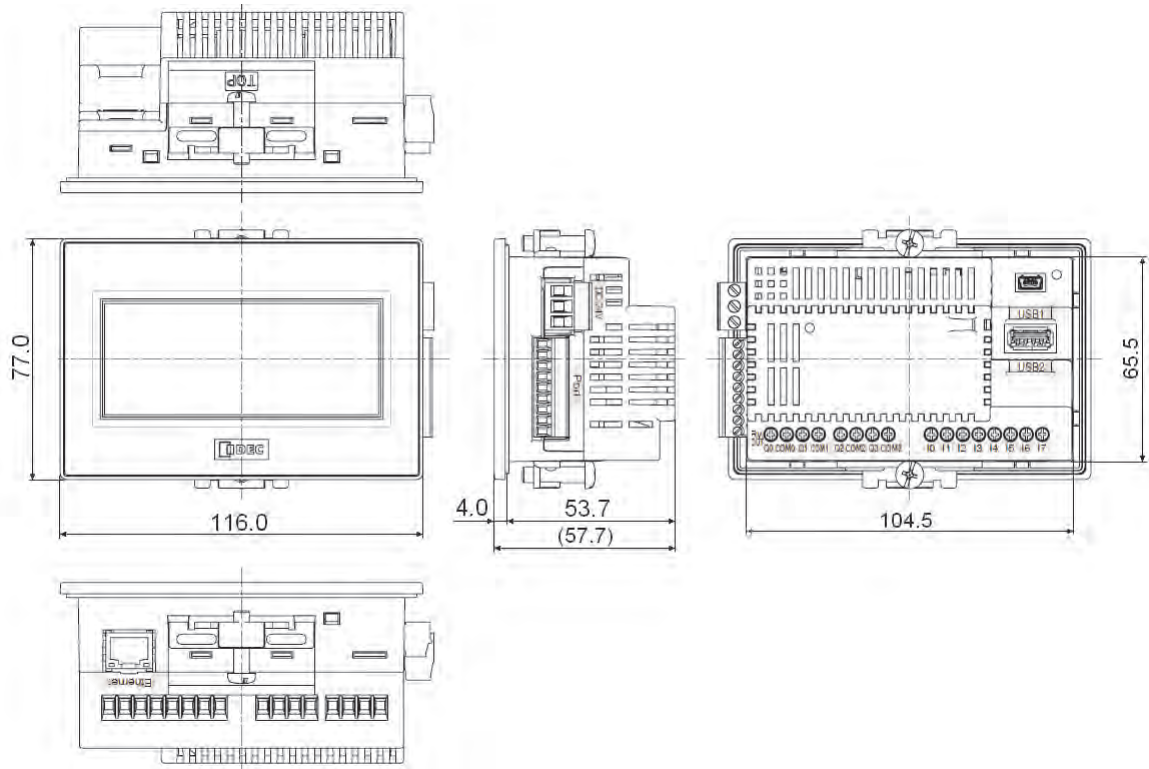

<Cable Attached Dimensions>

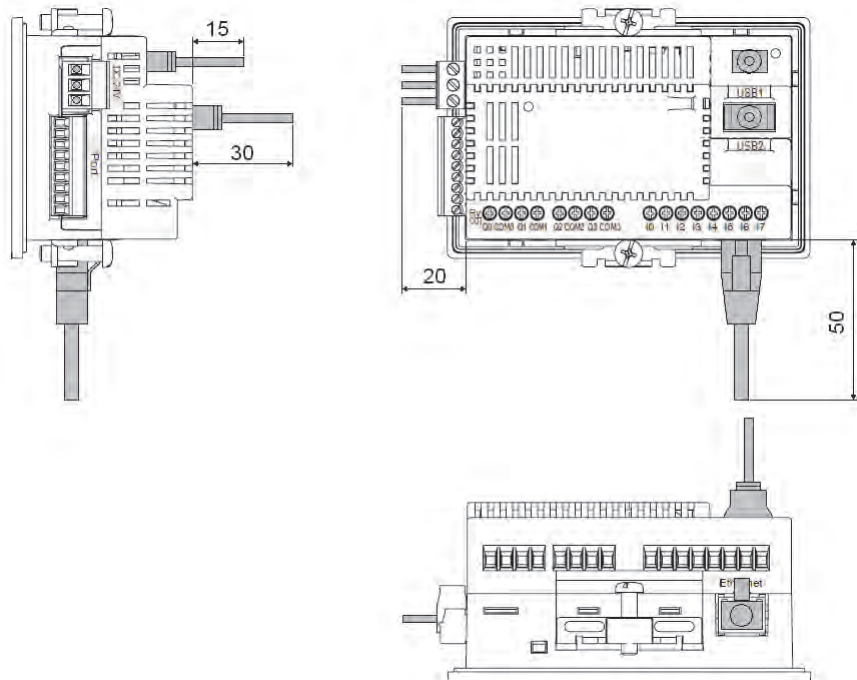

Depending on the type of connection cable used the dimensions shown above will change. The dimensions given here are intended for reference only.

■ FT1A-*14KA/SA

Unit: mm

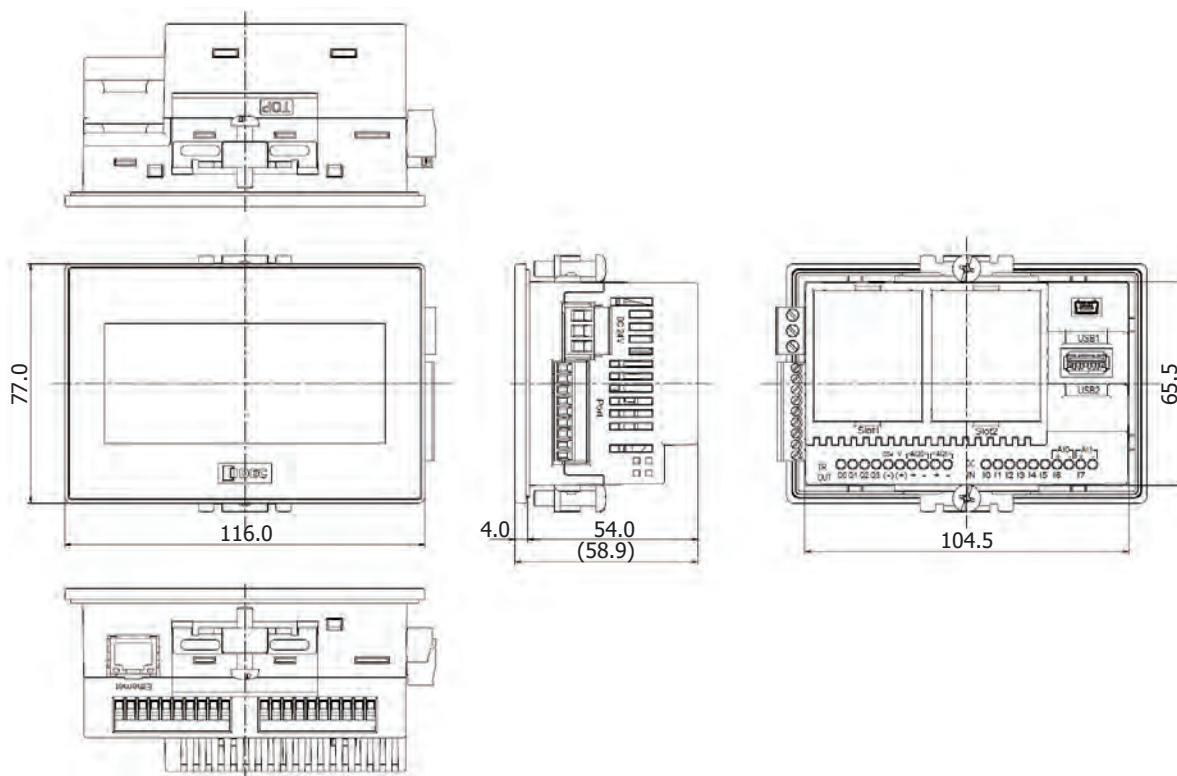

<Cable Attached Dimensions>

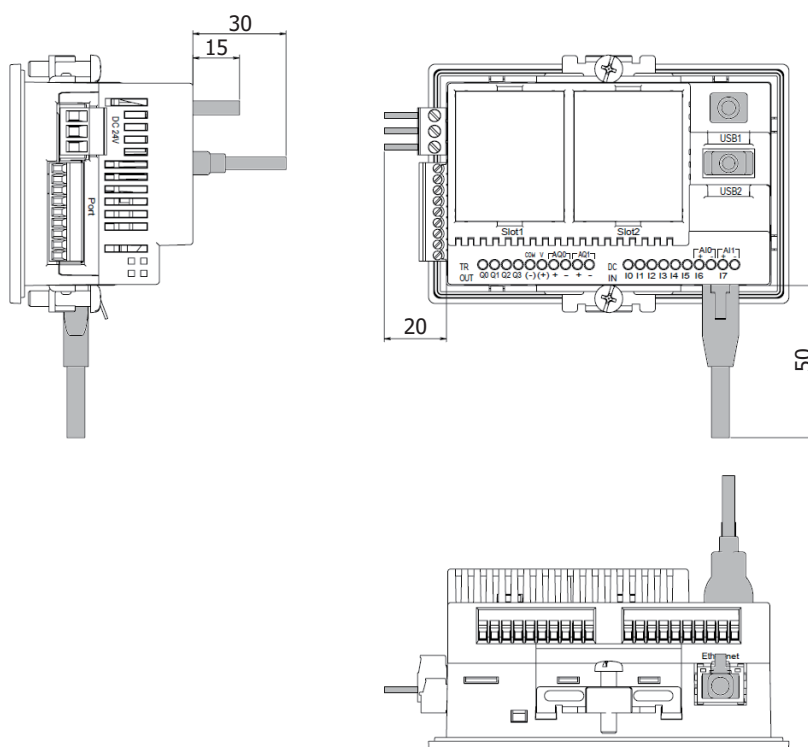

Depending on the type of connection cable used the dimensions shown above will change. The dimensions given here are intended for reference only.

1.7 Installation

● Operating Environment

For designed performance and safety of the Touch, do not install the Touch in the following environments:

- Where dust, briny air, or iron particles exist.
- Where oil or chemical splashes for a long time.
- Where oil mist is filled.
- In direct sunlight.
- Where strong ultraviolet rays exist.
- Where corrosive or combustible gasses exist.
- Where the Touch is subjected to shocks or vibrations.
- Where condensation occurs due to rapid temperature change.
- Where high-voltage or arc-generating equipment (electromagnetic contactors or circuit protectors) exists in the vicinity.

● Ambient Temperature

- Allow sufficient space for ventilation, and install the equipment away from heat sources.
- Allow at least 100mm between the Touch and walls or other equipment.
- Do not install the Touch where the ambient temperature exceeds the rated operating ambient temperature range. When mounting the Touch in such locations, provide a forced air-cooling fan or air-conditioner to keep the ambient temperature within the rated temperature range.
- The Touch is designed to install on a vertical plane so that natural air-cooling is provided. If you install it using any other orientation, use forced-air cooling, or lower the ambient operating temperature.

Derating

■ FT1A-*12RA

When using the Touch at an ambient temperature of 45°C or higher, reduce the output current of each output terminal as shown in the figure below. *1

Installed upright in landscape orientation

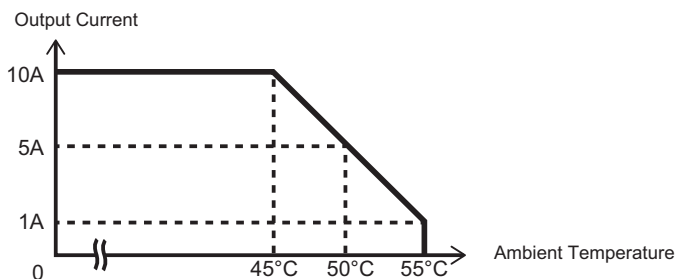

If operating the FT1A-*12RA in a high-temperature environment, reducing the brightness of the backlight can help to limit the temperature rise of internal components.

The relationship between ambient temperature, the output current of each output terminal, and brightness is approximately as shown in the figure below.

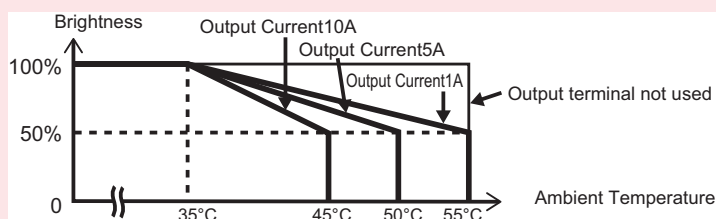

The values shown above may vary with individual products. Please use this information as a reference at the time of design.

*1 FT1A-*12RA-*: The UL and c-UL certified operating temperature is 0 to 50°C.

■ FT1A-*14KA/14SA

When used at ambient temperatures of 40°C or higher, limit the usage of analog current output and the analog cartridge as shown in the figure below.

Power Voltage Range	Touch Analog Output	Cartridge	Operating Temperature
20.4 to 24V DC	Voltage/current output cannot be used	Voltage output (FC6A-PK2AV)/ current output (FC6A-PK2AW) cannot be used	55°C
20.4 to 28.8V DC	Current output cannot be used	Voltage output (FC6A-PK2AV)/ current output (FC6A-PK2AW) cannot be used	50°C
20.4 to 28.8V DC	No restrictions	Voltage output (FC6A-PK2AV)/ current output (FC6A-PK2AW) cannot be used	45°C
20.4 to 28.8V DC	Current output cannot be used	Current output (FC6A-PK2AW) cannot be used	45°C
20.4 to 28.8V DC	No restrictions	No restrictions	40°C



If operating the FT1A-*14KA/14SA in a high-temperature environment, reducing the brightness of the backlight can help to limit the temperature rise of internal components.

The relationship between ambient temperature and brightness is approximately as shown in the figure below.

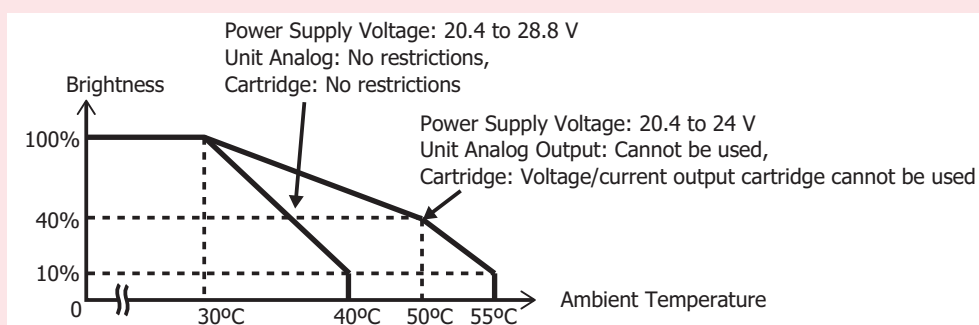

The values shown above may vary with individual products. Please use this information as a reference at the time of design.

● Installation

- Make a panel cut-out on the panel with the dimensions shown below.

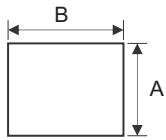

Unit: mm

A		B		Panel Cut-out
66.0	+1.0 0	105.0	+1.0 0	1.0 to 5.0

- The Touch has the mounting clip positions not only on the top and bottom side (0.3 to 0.35 N•m).

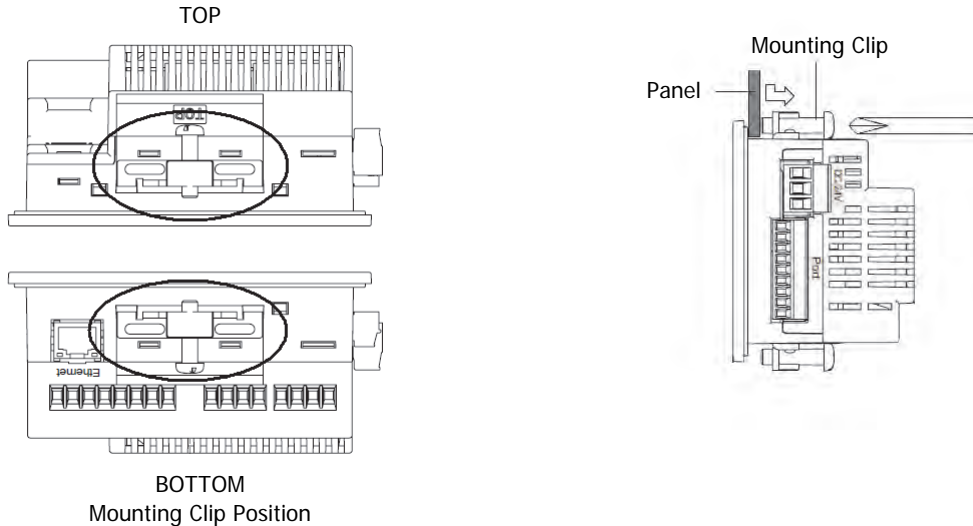





CAUTION

- **Do not tighten excessively, otherwise the Touch may warp and cause wrinkle on the display, or impair the waterproof characteristics.**
- **If the mounting clips are tightened obliquely to the panel, the Touch may fall off the panel.**
- **When installing the Touch into a panel cut-out, make sure that the gasket is not twisted. Especially when re-installing, take special care because any twists in the gasket will impair the waterproof characteristics.**
- **Even in the panel thickness range, there is a risk that the waterproof characteristics cannot be maintained due to the panel materials and size.**

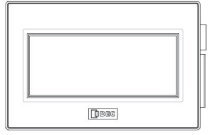
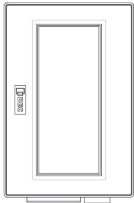
● Orientation

The Touch is designed to install on a vertical landscape. If you install it using any other orientation, confirm the limitations about operating temperature and the use of the Touch.

Orientation		Operating Ambient Temperature (no freezing)	
		FT1A-M (Monochrome LCD models)	FT1A-C (Color LCD models)
Vertical	 Vertical landscape Portrait	0 to 55°C	-20 to 55°C
	 Portrait (Clockwise)	0 to 50°C	-20 to 50°C
	 Portrait (Counter Clockwise)	0 to 55°C	-20 to 55°C
	 Horizontal (Flip)	0 to 55°C	-20 to 55°C
 Horizontal		0 to 50°C	-20 to 50°C



- When installing the Touch in a diagonal, the limitations are same as a horizontal.
- Confirm the visibility of the display in a final installation.

1.8 Attaching Cartridges (FT1A-*14KA/SA only)

- 1 Insert flat head screwdrivers into the screwdriver insertion slots in both locations of the unit, and while pushing the tabs of the cartridge cover, pull the cartridge cover directly upward to remove it.

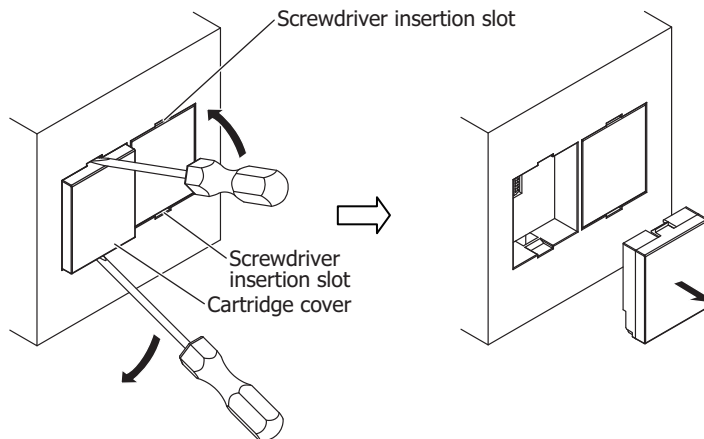

- 2 Pay careful attention to the direction of the cartridge and attach it directly onto the unit.

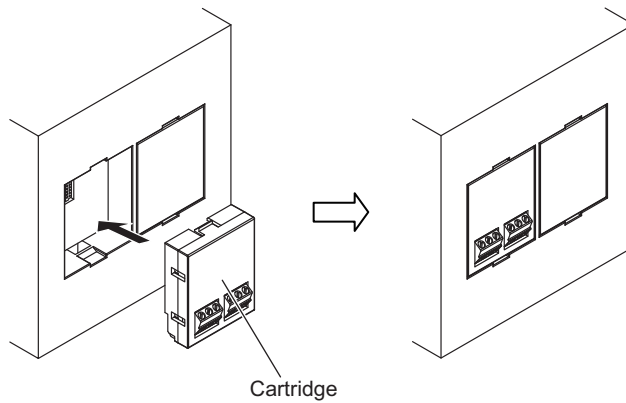

CAUTION

Attach the cartridge directly onto the unit. If the cartridge is attached when tilted, it may be damaged or cause communication problems.

1.9 Wiring

⚠ CAUTION

- Turn off the power supply before wiring.
- Make the wiring as short as possible and run all wires as far away as possible from high-voltage and large-current cables. Follow all the procedures and precautions when wiring the Touch.
- Separate the Touch power supply wiring from the power lines of I/O devices and motor equipment.
- Ground the functional earth terminal to make sure of correct operation.
- Do not touch the terminals during communication. Doing so may result in electrical shock.
- When keeping power ON, terminals connected to external devices may reach high temperatures. Do not touch the terminals immediately after turning the power off.
- Do not touch the terminals immediately after turning the power off. Doing so may result in electrical shock.
- Insert and crimp the wire to the end portion of the ferrule.
- Always use ferrules when wiring stranded wire and multiple wires to the terminal block. Otherwise there is a risk of wires becoming disconnected.

● Power Supply Terminal

- Pin assignment is shown in the following table.



+	Power supply 24V DC (+24V)
-	Power supply 0V (0V)
⏏	Functional Earth (FE)

- Use applicable cables for wiring and recommended ferrules (made by Phoenix Contact) as follows.

Applicable Cable	AWG16 to AWG22 Stripped wire length 7 mm (Solid wire)
Recommended ferrule	AI 0.34-8 TQ (For AWG22, For 1 wire) AI 0.5-8 WH (For AWG20, For 1 wire) AI 0.75-8 GY (For AWG18, For 1 wire) AI 1-8 RD (For AWG18, For 1 wire) AI 1.5-8 BK (For AWG16, For 1 wire) AI-TWIN 2×0.5-8 WH (For AWG20, For 2 wires) AI-TWIN 2×0.75-8 GY (For AWG18, For 2 wires) (Phoenix Contact)
Tightening Torque	0.5 to 0.6 N•m (Screwdriver SZS 0.6 x 3.5, Phoenix Contact)

● Cautions when connecting external devices

The Touch power supply is non-isolating. Interference or external noise from external devices due to wiring may cause adverse effects on the internal circuits of the Touch or external devices.

To prevent such damage, choose a proper solution depending on your system setup.

- Use a separate earth ground from the external noise source device.
- The wire for grounding should be thick and short in order to direct the noise from the noise source device to the earth ground.
- Use a separate power supply from the external noise source device.
- Insert an isolator on the communication line of the Touch and the non-isolated communication device (i.e. PLC) to prevent damage.

● Cautions for using the Touch connected to a computer

When connecting the Touch to a computer via the Serial Interface (Port) or USB Interface, the Touch or the computer may break down depending on the conditions of the computer. Make sure of the following cautions, in order to prevent an accident.

- If the computer has a 3-pin power plug or power plug with a ground lead type, make sure to use a plug socket including a ground input electrode or ground the earth lead, respectively.
- If the computer has a 2-pin power plug without ground lead, follow the procedure below when connect the Touch to the computer.
 - (1) Pull out the power plug of the computer from the AC outlet.
 - (2) Connect the Touch to the computer.
 - (3) Insert the power plug of the computer into the AC outlet.

1.10 USB Cable Lock Pin Attachment

When using the USB interface (USB1, USB2), attach the USB cable lock pin to prevent disconnecting the USB cable from the Touch.

- 1 Insert the USB cable into the USB port.
- 2 Strain the "Edge part" of the USB cable lock pin, and insert the "Edge part" to the 2 holes upper the USB port.

Edge Part → Clamp part

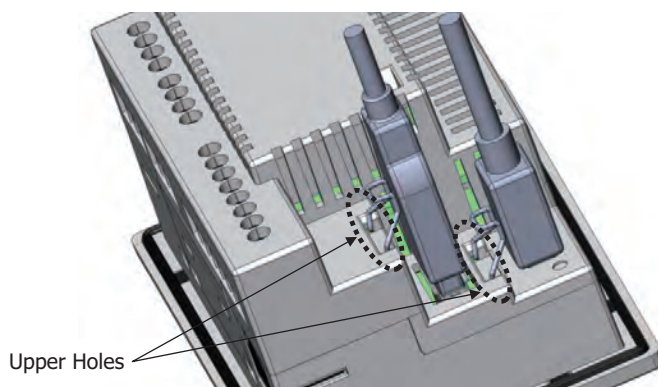

- 3 Fasten the USB clamp band around the USB cable and the clamp part, secure them tightly.

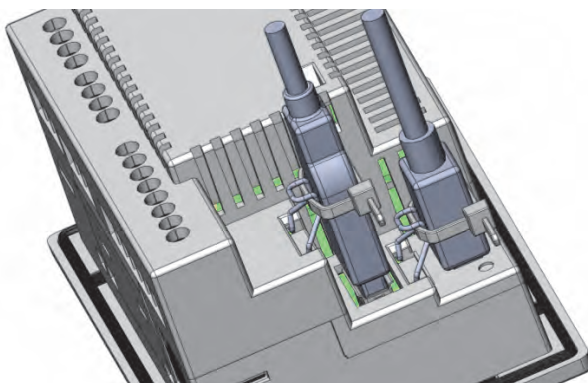



Fasten the USB clamp band without the space between the clamp part and it, and the inclination.

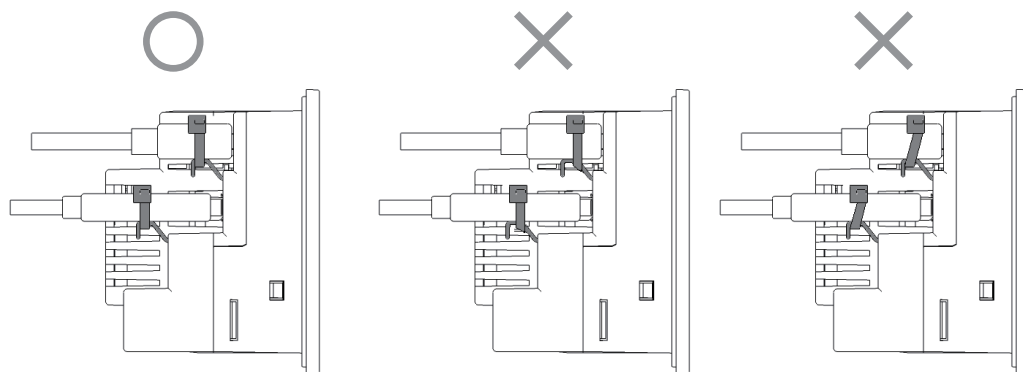

1.11 Maintenance and Inspection

Maintain and inspect the Touch periodically to ensure the best performance. Do not disassemble, repair, or modify the Touch during inspection.

Display	Wipe any stain of the display using a soft cloth slightly dampened with neutral detergent or alcoholic solvent. Do not use solvents such as thinner, ammonia, strong acid, and strong alkaline.
Terminals, Connectors	Check the terminals and connectors to make sure of no loose screws, incomplete insertion, or disconnected lines.
Mounting Clips	Make sure that all mounting clips and screws are tightened sufficiently. If the mounting clips are loose, tighten the screw to the recommended tightening torque.
Backlight	The Touch backlight cannot be replaced by the customer. When the backlight needs to be replaced, contact IDEC.
Touch Panel	A gap may be caused in the operation accuracy of the touch panel by the secular distortion, etc. Adjust the touch panel according to the following procedure when there is a gap in the operation of the touch panel.

● Maintenance Screen

Turn on the power to the Touch, then press and hold the upper-left corner of the screen for three seconds or longer. The Maintenance Screen appears on the screen.

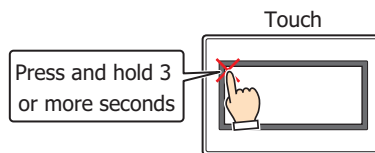

Maintenance Screen (Color LCD models)

Maintenance		X
System Mode	Device Monitor	
Brightness	Ladder Monitor	
Ladder Start/Stop		

Maintenance Screen (Monochrome LCD models)

Maintenance		X
System Mode	Device Monitor	
Brightness/ Contrast	Ladder Monitor	
Ladder Start/Stop		

- Permission to show the Maintenance Screen can be set using WindO/I-NV3 software. For details, refer to Chapter 3 "3.1 System Tab" on page 3-19.
- The Maintenance Screen is not displayed in the System Mode.

● System Mode

Press the **System Mode** at the top of the Maintenance Screen. The Top Page appears.

Top Page (Color LCD models)

SYSTEM MODE TOP PAGE		
Run	Main Menu	
2012/JUL/20/FRI 14:30:00		
IP Add. : 192.168.0.1 (DHCP)		
<<	BRIGHTNESS 31	>>

Top Page (Monochrome LCD models)

SYSTEM MODE TOP PAGE		
Run	Main Menu	
2012/JUL/20/FRI 14:30:00		
IP Add. : 192.168.0.1 (DHCP)		
<<	CONTRAST 31	>>
<<	BRIGHTNESS 31	>>

Initial Setting, Self Diagnosis and Initialization of the data, etc can be executed in the System Mode.

● Adjusting the Brightness and Contrast

The brightness and contrast of the Touch display can be adjusted on the Adjust Brightness/Contrast Screen. Adjust the brightness and contrast to the best condition as required.

- 1 Press the **Brightness** (color LCD models) or **Brightness/Contrast** (monochrome LCD models) on the Maintenance Screen.

The Adjust Brightness/Contrast Screen appears.

Color LCD models

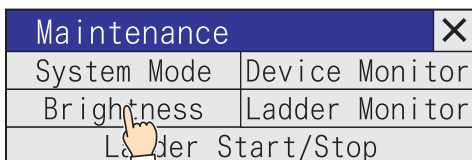

Monochrome LCD models

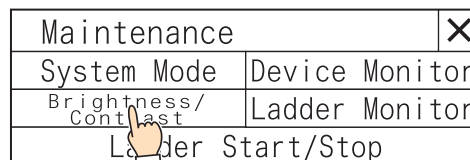

- 2 Press and at the bottom the Adjust Brightness/Contrast Screen to adjust the contrast to the optimal setting.

Color LCD models

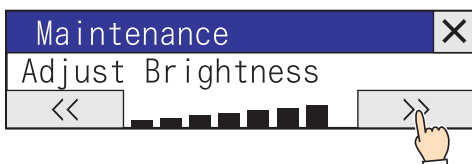

Monochrome LCD models

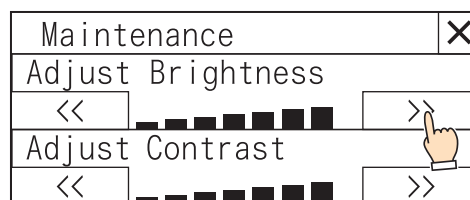

- 3 Press to close the Adjust Brightness/Contrast Screen.

To adjust the brightness and contrast in the System Mode, use and located at the bottom of the Top Page.

Top Page (Color LCD models)

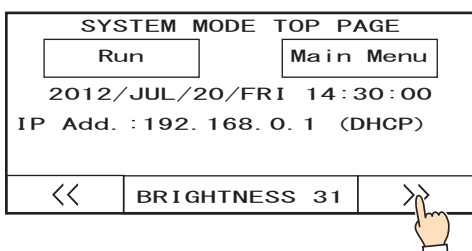

Top Page (Monochrome LCD models)

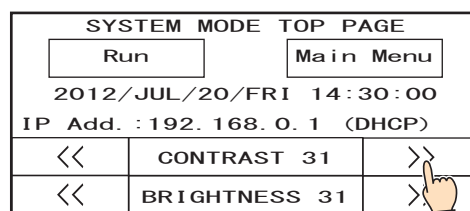

Since contrast adjustment is not possible on color LCD models, the contrast adjust function is not displayed.

● Adjusting the Touch Panel

A gap may be caused in the operation accuracy of the touch panel by the secular distortion, etc. Adjust the touch panel according to the following procedure when there is a gap in the operation of the touch panel.

- 1 Press **Main Menu** on Top Page in System Mode. The Main Menu appears.

Top Page (Color LCD models)

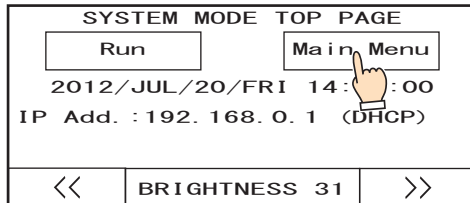

Top Page (Monochrome LCD models)

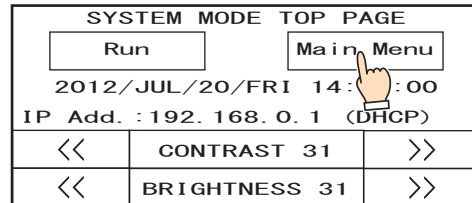

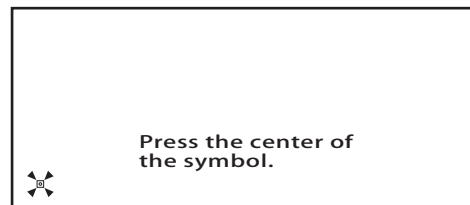

- 2 Press **Init Set, Initialize,** and then **Touch PnlAdj**. The confirmation screen appears and asks "Adjust Touch Panel setting?" is displayed. Press **Yes**.
The Touch Panel Adjust Screen is displayed.
- 3 Press the center of the , then the position of the symbol changes one after another. Press five symbols sequentially.



When pressing , make sure to press the center of the symbol. This will ensure the accuracy of the touch panel operation.

- 4 When normally recognized, the confirmation screen of **2** is restored.

At step **3**, when pressing a point away from the center of the , a recognition error will result. Then the  returns to the initial position, then repeat the step of **3** again.

2 Analog Cartridge

2.1 Packing Contents

Before installing the analog cartridge, make sure that the specifications of the product conform to your requirements, and that no parts are missing or damaged due to accidents during transportation.

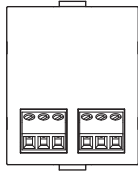
Name	Pcs/pack	
Cartridge	1	
Instruction Sheet	1	

2.2 Type Number

Cartridge type	Inputs/outputs	Type	Type No.
Analog Output Cartridge	Output: 2	Voltage output: 0 to 10 V	FC6A-PK2AV
	Output: 2	Current output: 4 to 20 mA	FC6A-PK2AW
Analog Input Cartridge	Input: 2	Voltage input: 0 to 10 V Current input: 0 to 20 mA, 4 to 20 mA	FC6A-PJ2A
	Input: 2	Thermocouple input: K, J, R, S, B, E, T, N, C Resistance thermometer input: Pt100, Pt1000, Ni100, Ni1000	FC6A-PJ2CP

2.3 Part Names

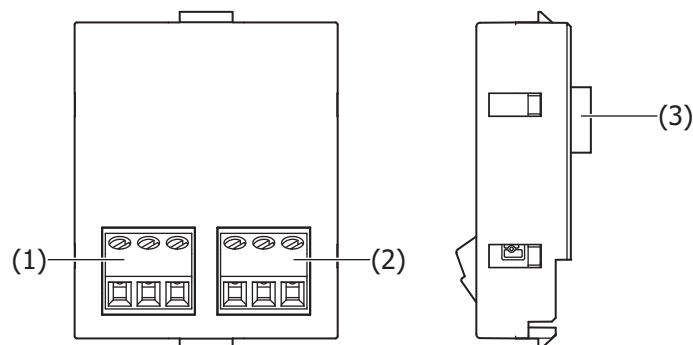

No.	Name	Description
(1)	Terminal channel 0	
(2)	Terminal channel 1	
(3)	Connection connector for the Touch	

2.4 Specifications

Type Number	FC6A-PK2AV	FC6A-PK2AW	FC6A-PJ2A	FC6A-PJ2CP
Rated Voltage	5.0 V, 3.3 V (Supplied from the Touch)			
Consumption Current	5.0 V: 70 mA 3.3 V: 30 mA	5.0 V: 185 mA 3.3 V: 30 mA	5.0 V: - 3.3 V: 30 mA	5.0 V: - 3.3 V: 30 mA
Weight	15 g	15 g	15 g	15 g

■ Analog Output Specifications

Type Number	FC6A-PK2AV		FC6A-PK2AW
Output Type	Voltage Range	0 to 10 V	
	Current Range	-	4 to 20 mA
Load	Impedance	2 k Ω min.	500 Ω max.
	Load Type	Resistance load	
D/A Conversion	Cycle Time	20 ms	20 ms
	Settling Time	40 ms max.	20 ms max.
	Total Output System Transfer Time	60 ms+1 scan	40 ms+1 scan
Output Error	Maximum Error at 25°C	$\pm 0.3\%$ of FS	$\pm 0.3\%$ of FS
	Temperature Coefficient	$\pm 0.02\%/^{\circ}\text{C}$ of FS	$\pm 0.02\%/^{\circ}\text{C}$ of FS
	Reproducibility After Stabilization Time	$\pm 0.4\%$ of FS	$\pm 0.4\%$ of FS
	Non-linearity	$\pm 0.01\%$ of FS	$\pm 0.01\%$ of FS
	Output Ripple	30 mV max.	30 mV max.
	Overshoot	0%	0%
	Maximum Error	$\pm 1.0\%$ of FS	$\pm 1.0\%$ of FS
Data	Digital Resolution	4,096 increments (12bit)	4,096 increments (12bit)
	LSB Output Value	2.44 mV (0 to 10 V)	3.91 μA (4 to 20 mA)
	Data Format in Application	0...4095 (0 to 10 V)	0...4095 (4 to 20 mA)
	Monotonicity	Yes	Yes
	Open Current Loop	-	Cannot be detected
Noise Resistance	Maximum Temporary Deviation during Electrical Noise Tests	$\pm 4.0\%$ of FS max.	$\pm 4.0\%$ of FS max.
	Recommended Cable	Shielded twisted pair	
	Crosstalk	1 LSB max.	1 LSB max.
Isolation	None		None
Effect When Output is Incorrectly Wired	No Damage		No Damage
Calibration to Maintain Rated Accuracy	Not possible		Not possible

■ Analog Input Specifications

Type Number	FC6A-PJ2A		FC6A-PJ2CP	
Input Type	Voltage input	Current input	Resistance thermometer	Thermocouple
Input Range	0 to 10 V	4 to 20 mA 0 to 20 mA	Pt100: -200 to +850 °C (-328 to 1562 °F) Pt1000: -200 to +600 °C (-328 to 1112 °F) Ni100: -60 to +180 °C (-76 to 356 °F) Ni1000: -60 to +180 °C (-76 to 356 °F)	(K)-200 to 1300 °C (-328 to 2372 °F) (J)-200 to 1000 °C (-328 to 1832 °F) (R)0 to 1760 °C (32 to 3200 °F) (S)0 to 1760 °C (32 to 3200 °F) (B)0 to 1820 °C (32 to 3308 °F) (E)-200 to 800 °C (-328 to 1472 °F) (T)-200 to 400 °C (-328 to 752 °F) (N)-200 to 1300 °C (-328 to 2372 °F) (C)0 to 2315 °C (32 to 4199 °F)
Input Impedance	1 M Ω min.	250 Ω max.	1 M Ω min.	
Allowable Conductor Resistance	-	-	10 Ω max.	
Input Detection Current	-	-	TYP: 0.2 mA 1.0 mA max.	

Type Number		FC6A-PJ2A		FC6A-PJ2CP	
AD Conversion	Sample Duration Time	10 ms	10 ms	250 ms	250 ms
	Total Input System Transfer Time	20 ms+1 scan		500 ms+1 scan	
	Type of Input	Single-ended input			
	Operating Mode	Self-scan			
	Conversion Method	SAR			
Input Error	Maximum Error at 25°C	±0.1% of FS		±0.1% of FS	
	Temperature Coefficient	±0.02%/°C of FS		±0.02%/°C of FS	
	Reproducibility After Stabilization Time	±0.5% of FS		±0.5% of FS	
	Non-linearity	±0.01% of FS		±0.01% of FS	
	Maximum Error	±1.0% of FS		±1.0% of FS	
Data	Digital Resolution	4,096 increments (12bit)		Pt100: 10500 (14bit) Pt1000: 8000 (13bit) Ni100: 2400 (12bit) Ni1000: 2400 (12bit)	
	LSB Input Value	2.44 mV (0-10 V)	4.88 µA (0 to 20 mA) 3.91 µA (4 to 20 mA)	0.1°C 0.18°F	0.1°C 0.18°F
	Data Format in Application	Can be arbitrarily set for each channel in the range of -32,768 to 32,773			
	Monotonicity	Yes			
Noise Resistance	Maximum Temporary Deviation during Electrical Noise Tests	±4.0% of FS max.			
	Recommended cable	Shielded twisted pair			
	Crosstalk	1 LSB max.			
Isolation	None				
Effect When Input is Incorrectly Wired	No Damage				
Maximum Allowable Constant Load *1 (non-destructive)	13 V	40 mA	13 V		
Input Type Modification	Software programming				
Calibration to Maintain Rated Accuracy	Not possible				

*1 The maximum amount of voltage value or current value that can be input without damaging the hardware.

2.5 Dimensions

Unit: mm

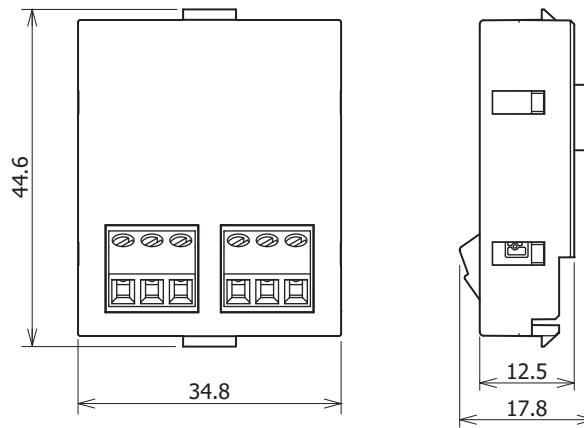

2.6 Installation

Refer to Chapter 29 "1.8 Attaching Cartridges (FT1A-*14KA/SA only)" on page 29-22.

2.7 Wiring

⚠ CAUTION

- Do not connect a thermocouple to a hazardous voltage component (60V DC or peak 42.4 V or higher component).
- Always check the wiring before turning on the power. If the wiring is incorrect, the analog cartridge may be damaged. When there is a risk of malfunction due to noise, use a shielded cable for the wiring and connect both ends of the shield to the FG.

● Terminal Arrangement

FC6A-PK2AV

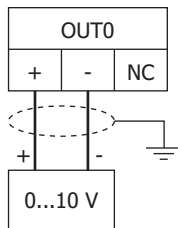

Analog voltage input device

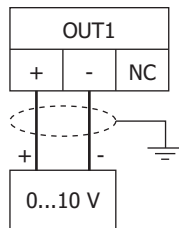

Analog voltage input device

FC6A-PK2AW

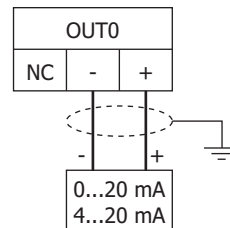

Analog current input device

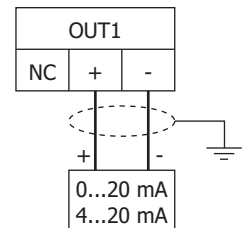

Analog current input device

FC6A-PJ2A

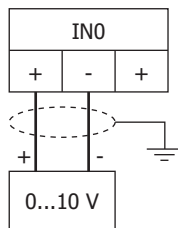

Analog voltage output device

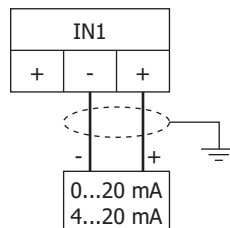

Analog current output device

FC6A-PJ2CP

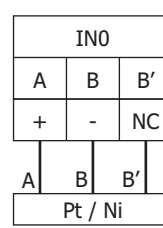

Resistance thermometer

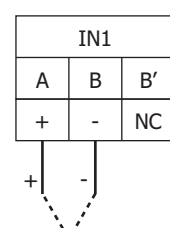

Thermocouple

Chapter 30 Troubleshooting

This chapter describes the errors that may occur with the Touch and the measures necessary to correct these errors.

1 Error Messages

The Touch displays a variety of error messages in order to assist you in quickly analyze and resolve problems with the hardware, communications system, and user screen data.

1.1 Errors Displayed on the Screen

The following error messages are displayed in the event of communication system problems and problems with user screen data. When an error occurs, take the appropriate indicated action. If an error persists despite your attempts to correct it, contact your nearest sales representative.

Error Message	Cause	Solution
Waiting for default screen No.	The default screen number is set at 0.	Write the screen number to System Area 1 (address+0), or set the Default Screen spin box on the System tab of the Project Settings dialog box to a value other than 0.
No screen data	The specified Base Screen does not exist.	Set the Base Screen and download it to the Touch.
Processing error	<ul style="list-style-type: none"> This message is displayed when a value is divided by 0. There is data which cannot be handled with the BCD4, BCD8, or float32 data types. Incorrect calendar data has been saved to the Calendar of the Data Display. 	Check the calculation or settings.
Communication Error	An error occurred during communication with the external device.	Check the communication lines and the communication settings. During 1: N communications, the port number of the external device on which the Communication error has occurred.
Device range error	<ul style="list-style-type: none"> The data is written to the device with the address out of the range. The number of devices exceeds the limitation. 	Check the device settings.
No USB flash drive exists	No USB flash drive inserted when the unit attempted to access the USB flash drive.	Insert a USB flash drive.
This USB flash drive is not available	<ul style="list-style-type: none"> The type of USB flash drive is not recognized by the Touch. The USB flash drive is broken. 	Please use a new recommended USB flash drive.
USB flash drive Access Error	When the unit attempted to access the USB flash drive: <ul style="list-style-type: none"> The USB flash drive did not have enough free space. The USB flash drive was removed partway through. The USB flash drive was broken. 	Create some free space on the USB flash drive or get a new one.
ZNV file is not found	The project file (ZNV format) was not in the specified location on the external memory when a download was made using the Project Data Transfer function.	Check whether or not the file is in the specified location on the external memory.
ZNV file format Error	When a download was made using the Project Data Transfer function: <ul style="list-style-type: none"> The project file is not in ZNV format. The file is corrupt. 	Remake the project file (ZNV format).
Product Series is not correct	When a download was made using the Project Data Transfer function, the model of the downloaded project and the model of the destination Touch were different	Check that the model name that is set in the file you want to download is the same as the model name of the destination Touch.

Error Message	Cause	Solution
Script error	An error occurred for a process in execution of the script.	Check the value of LSD52 and LSD53, and correct the script. For details, refer to Chapter 20 "Script" on page 20-1.
Device write error	The script generated a lot of write data, and the write operation failed.	Reduce the number of write operations to be performed at the same time.
Insufficient memory error	The resource memory of the Touch is insufficient because of the use of a large number of the following parts. <ul style="list-style-type: none"> Pilot Lamps, Multi-State Lamps, and Picture Displays with the Recover Background checkbox is selected. Message Display and Message Switching Display with the Scroll checkbox is selected. Parts over the number limit of parts that can be set per screen by overlapping Base Screen. 	Clear the Recover Background or Scroll checkbox, or delete parts to reduce memory resource utilization.
Indirect device error	Indirect write failure with Word Button or Word Write Command.	Do not perform indirect read-write with external devices while HMI Special Internal Relay LSM14 or LSM15 is ON.
Check Interface settings	Touch cannot change into the Run mode because the Interface settings are not correct.	Modify settings using the Communication Interface tab of the Project Settings dialog box before downloading.
Network off-line	This error message is only displayed when O/I Link is being used.	See the "External Device Setup Manual" for details.
TP/CP	The control device timer or counter preset value was modified.	Press Main Menu , Initial Setting , and then TP/CP Change in order on the Top Page in the System Mode
Output circuit error	The circuit for the relay output did not operate normally.	If this problem occurs frequently, the Touch may be damaged and require replacement.
Analog input error	The user program in which the operation mode of A10/A11 is configured as the current input is downloaded to Touch (relay output type).	Configure the operation mode of A10/A11 as the voltage input and download the project.
Overcurrent	Voltage input is applied is applied to A10/A11 that is configured as the current input, or the applied current input is more than 40 mA.	Confirm the applied current/voltage on A10/A11 of the Touch (transistor output type). When voltage is applied, configure the Operating Mode of A10/A11 as the voltage input and download the project. When current is applied, make sure that the current input applied is within the rated input (0 to 20 mA) and cycle the power to the Touch.

1.2 Low Battery Voltage

An internal battery maintains clock settings and log data in the Touch. When the battery runs out, keep register data, log data and other backup data will be cleared, and the contrast is reset to the default value. If this happens, the following message is displayed when the Touch is powered up, so take the indicated action.



This message does not show when the **Enable Low Battery Warning** check box on the **System** tab of the Project Settings dialog box is not selected.

Note that in this case, System Area 2 (address+2, bit 14) is set to 1. Turn ON the power again to set the value to 0.

Message	Description
Backup data lost	The Log Data and Calendar Data are lost. Set the clock again. Keep the power ON for about two days to charge the battery.



In case of storing Keep Relay or Keep Register to the flash memory using HMI Special Internal Relay (LSM10), stored data is transferred to the memory automatically when Backup data is lost.

2 Error Information

There are two kinds of errors with the control functions of the Touch: general errors and program execution errors. General errors can be checked by the state of a Special Data Register (D8005), and they can be cleared. Program execution errors can be checked by the state of a Special Data Register (D8006).

2.1 General Error Codes

The error code is stored in Special Data Register D8005. If '1' is stored in each bit of D8005, the corresponding error is occurring.

Also, general errors (D8005) and program execution errors (D8006) can be cleared by writing "1" to the most significant bit of Special Data Register D8005, using a ladder program or FBD program. Due to parts and communication, writing "1" to the most significant bit of D8005 will not clear errors.

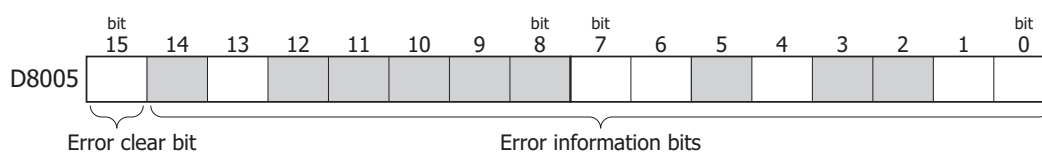

● General Error Code List

Bit No.	Item	Cause	Solution
0	Power Failure	This error indicates when the power supply is lower than the specified voltage. This error is also recorded when the power is turned off.	Clear the error code using WindLDR.
1	Watchdog Timer Error	The watchdog timer monitors the time required for one program cycle (scan time). When the time exceeds the allowed time, the watchdog timer indicates an error.	Clear the error code using WindLDR. If this error occurs frequently, the Touch has to be replaced.
2, 3	Reserved	–	–
4	Timer/Counter Preset Value Sum Check Error	The execution data of timer/counter preset values is corrupted. The timer/counter preset values are initialized to the values of the ladder program automatically. Note that changed preset values are cleared and that the original values are restored.	Clear the error code using WindLDR.
5	Reserved	–	–
6	Keep Data Sum Check Error	This error indicates that the data designated to be maintained during power failure is corrupted because of memory backup failure. Note that the "keep" data of internal relays and shift registers are cleared. Data of counters and data registers are also cleared.	If this error occurs in a short period of power interruption after the battery has been charged as specified, the battery is defective and the Touch has to be replaced. Clear the error code using WindLDR.
7	Program Syntax Error	This error indicates that the ladder program or FBD program has a syntax error.	Correct the ladder program or FBD program, and then download it to the Touch.
8 to 12	Reserved	–	–
13	Program Execution Error	This error indicates that invalid data is found during execution of a ladder program or FBD program. When this error occurs, special internal relay M8004 (program execution error) is turned on.	Refer to "2.2 Program Execution Error" on page 30-5 and fix and clear the error code. Clear the error code with WindO/I-NV3.
14	Reserved	–	–
15	Error clear bit	–	–

Example: This ladder program clears the error information using the error clear bit of special data register D8005.

Turn on M0 and turn on the upper bit of D8005. The error information is cleared at the end of the ladder scan.

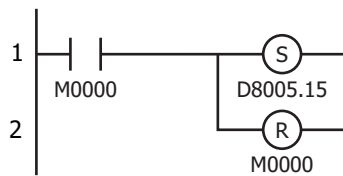

● Touch Operating Status and Output during Errors

If an error occurs, the operation and output states of the Touch will be as follows.

Error Items	Operating Status	Output	Checked at
Power failure	Stop	OFF	Any time
Watchdog timer error	Stop	OFF	Any time
Program (ROM) CRC error	Stop	OFF	Starting operation
TIM/CNT preset value sum check error	Maintained	Maintained	When checking a change in timer/counter setting values
Keep data error	Maintained/Stop ^{*1}	Maintained/Stop ^{*1}	Turning power on
Program syntax error	Stop	OFF	Downloading a ladder program or FBD program
Program execution error	Maintained	Maintained	Executing a ladder program or FBD program

*1 Operation starts to run and outputs are turned on or off according to the ladder program as default, but it is also possible to stop operation and turn off outputs using the Function Area Settings on WindLDR

2.2 Program Execution Error

This error indicates that invalid data is found during execution of a ladder program or FBD program. When this error occurs, the special internal relay M8004 (program execution error) is from 0 to 1. The detailed information of this error can be viewed from the error code stored in special data register D8006 (program execution error code).

● Ladder Program Execution Error Code (D8006)

Error Code	Error Details
1	Source/destination device is out of range.
2	MUL result is out of data type range.
3	DIV result is out of data type range, or division by 0.
4	BCDLS has S1 or S1+1 exceeding 9,999.
5	S1 is 10,000 or higher in the HTOB(W) instruction, or S1 is 100,000,000 or higher in the HTOB(D) instruction.
6	BTOH has any digit of S1 exceeding 9.
7	HTOA/ATOH/BTOA/ATOB has quantity of digits to convert out of range.
8	ATOH/ATOB has non-ASCII data for S1 through S1+4.
9	In the WEEK instruction or WEEK FB, the ON time data is out of range (hour data is 24 or higher, minute data is 60 or higher), or the OFF time data is out of range (hour data is 25 or higher, minute data is 60 or higher).
10	In the YEAR instruction or YEAR FB, the month and day data is out of range (month data is 13 or higher, day data is 32 or higher).
12	CVXTY/CVYTX is executed without matching XYFS. XYFS and CVXTY/CVYTX have the same S1, but have different data types.
13	CVXTY/CVYTX has S2 exceeding the value specified in XYFS.
14	Label in LJMP, LCALL, or DJNZ is not found.
16	PID instruction execution error.
18	Attempt was made to execute an instruction that cannot be used in an interrupt program. (Refer to Chapter 3 "4.9 Interrupt Input" on page 3-74.)
19	Attempt was made to execute an instruction that is not available for the external device.
21	DECO has S1 exceeding 255.
22	BCNT has S2 exceeding 256.
23	ICMP>= has S1 < S3.
25	BCDLS has S2 exceeding 7.
26	DI or EI is executed when interrupt input or timer interrupt is not programmed in the Function Area Settings.
27	Work area is broken when using DTML, DTIM, DTMH, DTMS, or TTIM.
28	S1 for trigonometric function instruction is invalid.
29	Result of F (float) data type instruction is out of the data type range.
30	The number of bits configured in SFTL instruction, SFTR instruction or SFR FB exceeds the valid range.
31	In the FIFO instruction, the FIEX instruction or the FOEX instruction was executed before the FIFO data file was registered.
32	TADD, TSUB, HOUR, or HTOS has invalid data for source device S1 or HOUR FB has invalid data for Preset value.
34	NDSRC has invalid data for source device S3.
35	In the SUM instruction, the execution result exceeds the valid range for the selected data type, or S2 data is 0.
36	In a DLOG/TRACE instruction or DLOG/TRACE FB, the size of the CSV file has exceeded 5 MB.
42	The execution is unsuccessful in SCRPT instruction or SCRPT FB.
43	The minimum value is greater than the maximum value in RCMP FB.
44	The shift registers specified by the start shift register and the number of bits in SFR FB does not exist.
45	In RPULS FB, the lower limit of ON time is greater than the upper limit of ON time, or the upper limit of ON time is greater than the cycle.

3 Handling Problems

3.1 When You Cannot Download Project Data

If you are unable to download project data from the WindO/I-NV3, press the top left corner of the panel for three seconds while at the same time turning the power off and back on again.



When power is turned on again, the screen in the System Mode is displayed, and then Touch becomes downloadable status. If you download using Ethernet and O/I Link, check again each setting of TCP/IP and O/I Link before executing the download.

3.2 When the Backlight is OFF and the Buzzer Sounds

If you fail to download the runtime system to Touch, the backlight may turn to OFF and a buzzer may sound continuously every second, even after the power has been turned off and on again. If this happens, rectify the situation by doing the following:

Download the project and the runtime system by using WindO/I-NV3 via USB cable. When the Touch is in this state, projects cannot be downloaded via Ethernet or using an external memory.

To download the runtime system, when you download a project, click **Option** on the Download dialog box in WindO/I-NV3, and then select **Download Runtime system** on the Options dialog box.

3.3 When a Problem Occurs with a Control Function

This section describes the procedures to determine the cause of trouble and actions to be taken when any trouble of the Control Function occurs while operating the Touch. In case of any trouble, refer to the following table to determine the cause and to correct the error.

Problem	Cause	Action
Ladder program or FBD program doesn't execute.	M8000 is not "1".	Set "1" to M8000.
	The stop or reset input is designated using Function Area Settings.	Set "0" to the stop and reset inputs.
Input does not operate normally.	Input device is not "1".	Correct the program.
	Input device address is incorrect.	
	The input wiring is incorrect.	Correct the input wiring.
	The input terminal is not powered.	Supply the rated voltage to the input terminal.
Output does not operate normally.	Wiring or operation of external device is incorrect.	Correct the external device wiring.
	Output device addresses are incorrect.	Correct the ladder program or FBD program.
Output does not operate normally.	Output does not turn on and off.	The output circuit in the Touch is damaged. Replace the Touch.
	Touch output connection is incorrect.	Correctly connect the output.
Ladder program or FBD program cannot be stopped.	The stop or reset input is designated in the Function Area Settings.	Set "1" to the designated input.
	The designated stop or reset input does not turn on and off.	Input does not work normally. Replace the Touch.
	M8000 is not "0".	Set "0" to M8000.
Watchdog timer error occurs.	The scan time exceeds the time configured for the watchdog timer.	NOP instruction can reset the watchdog timer. Insert a NOP instruction into the ladder program so the time configured for the watchdog timer is not exceeded.
The interrupt/catch input cannot receive short pulses.	The input ON/OFF voltage level are not correct.	Make sure of correct input voltage.
Frequency measurement does not work.	Signals are not input to the Groups 1 through 5.	Select Single-phase High-speed Counter in the Groups 1 through 5.
	The function settings in WindLDR is not configured correctly.	Specify the used group in the frequency measurement settings.

Appendix

This chapter contains the Color Number Correspondence Table, and describes details about the Color Palette and other settings used in WindO/I-NV3.

1 Color Number Correspondence Table

This table is used when using Message Display and Script. Select a value from the Data column of the table and you can change the display color of an object.

Color No.	Data	Color No.	Data	Color No.	Data	Color No.	Data	Color No.	Data	Color No.	Data
		041	0x29	083	0x53	125	0x7D	167	0xA7	209	0xD1
000	0x00	042	0x2A	084	0x54	126	0x7E	168	0xA8	210	0xD2
001	0x01	043	0x2B	085	0x55	127	0x7F	169	0xA9	211	0xD3
002	0x02	044	0x2C	086	0x56	128	0x80	170	0xAA	212	0xD4
003	0x03	045	0x2D	087	0x57	129	0x81	171	0xAB	213	0xD5
004	0x04	046	0x2E	088	0x58	130	0x82	172	0xAC	214	0xD6
005	0x05	047	0x2F	089	0x59	131	0x83	173	0xAD	215	0xD7
006	0x06	048	0x30	090	0x5A	132	0x84	174	0xAE	216	0xD8
007	0x07	049	0x31	091	0x5B	133	0x85	175	0xAF	217	0xD9
008	0x08	050	0x32	092	0x5C	134	0x86	176	0xB0	218	0xDA
009	0x09	051	0x33	093	0x5D	135	0x87	177	0xB1	219	0xDB
010	0x0A	052	0x34	094	0x5E	136	0x88	178	0xB2	220	0xDC
011	0x0B	053	0x35	095	0x5F	137	0x89	179	0xB3	221	0xDD
012	0x0C	054	0x36	096	0x60	138	0x8A	180	0xB4	222	0xDE
013	0x0D	055	0x37	097	0x61	139	0x8B	181	0xB5	223	0xDF
014	0x0E	056	0x38	098	0x62	140	0x8C	182	0xB6	224	0xE0
015	0x0F	057	0x39	099	0x63	141	0x8D	183	0xB7	225	0xE1
016	0x10	058	0x3A	100	0x64	142	0x8E	184	0xB8	226	0xE2
017	0x11	059	0x3B	101	0x65	143	0x8F	185	0xB9	227	0xE3
018	0x12	060	0x3C	102	0x66	144	0x90	186	0xBA	228	0xE4
019	0x13	061	0x3D	103	0x67	145	0x91	187	0xBB	229	0xE5
020	0x14	062	0x3E	104	0x68	146	0x92	188	0xBC	230	0xE6
021	0x15	063	0x3F	105	0x69	147	0x93	189	0xBD	231	0xE7
022	0x16	064	0x40	106	0x6A	148	0x94	190	0xBE	232	0xE8
023	0x17	065	0x41	107	0x6B	149	0x95	191	0xBF	233	0xE9
024	0x18	066	0x42	108	0x6C	150	0x96	192	0xC0	234	0xEA
025	0x19	067	0x43	109	0x6D	151	0x97	193	0xC1	235	0xEB
026	0x1A	068	0x44	110	0x6E	152	0x98	194	0xC2	236	0xEC
027	0x1B	069	0x45	111	0x6F	153	0x99	195	0xC3	237	0xED
028	0x1C	070	0x46	112	0x70	154	0x9A	196	0xC4	238	0xEE
029	0x1D	071	0x47	113	0x71	155	0x9B	197	0xC5	239	0xEF
030	0x1E	072	0x48	114	0x72	156	0x9C	198	0xC6	240	0xF0
031	0x1F	073	0x49	115	0x73	157	0x9D	199	0xC7	241	0xF1
032	0x20	074	0x4A	116	0x74	158	0x9E	200	0xC8	242	0xF2
033	0x21	075	0x4B	117	0x75	159	0x9F	201	0xC9	243	0xF3
034	0x22	076	0x4C	118	0x76	160	0xA0	202	0xCA	244	0xF4
035	0x23	077	0x4D	119	0x77	161	0xA1	203	0xCB	245	0xF5
036	0x24	078	0x4E	120	0x78	162	0xA2	204	0xCC	246	0xF6
037	0x25	079	0x4F	121	0x79	163	0xA3	205	0xCD	255	0xF7
038	0x26	080	0x50	122	0x7A	164	0xA4	206	0xCE		
039	0x27	081	0x51	123	0x7B	165	0xA5	207	0xCF		
040	0x28	082	0x52	124	0x7C	166	0xA6	208	0xD0		

2 View Browser

The View Browser displays the list of graphics that have been prepared in advance in WindO/I-NV3. The settings displayed on View Browser vary based on the parts.

These graphics can be used as the outline of parts.

Example: Bit Button

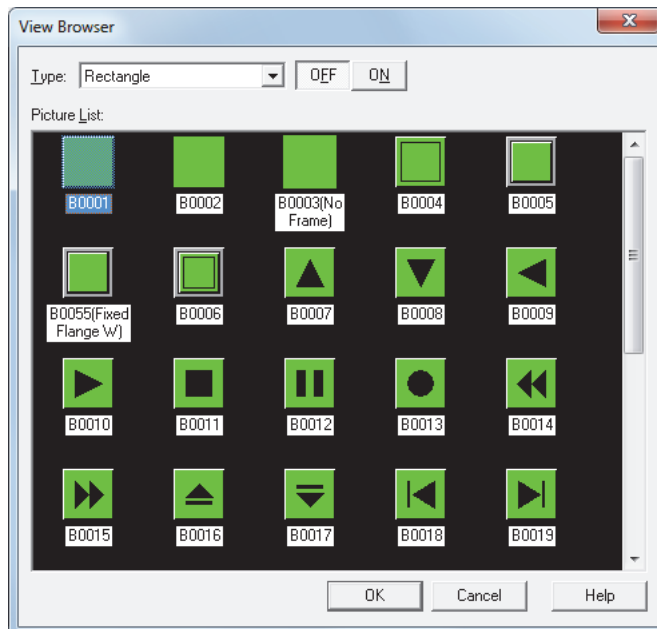

- **Type**
Selects the category of graphics.
- **OFF, ON**
Displays the graphic when OFF or ON. Click **ON** or **OFF** to switch the graphics displayed on the list.
- **Picture List**
Displays the list of registered graphics. Select the graphic to use as the outline of the part.
- **OK**
Closes the View Browser and sets the selected graphic to the caller.

3 Color Palette

The Color Palette is used to select colors for drawing objects, text on parts, outlines, flanges, plates and other objects. The Color Palette appears when you click on the **Color** button in the object's Properties dialog box.

● Functions of Color Palette buttons

■ Color

Selects a color. Clicking these buttons sets the **Color** button to the selected color.

■ >>More, <<Less

Switches the palette display. Clicking >> **More** shows all the colors assignable to the **Color** button. Clicking << **Less** shows only the basic colors assignable to the **Color** button.

■ TMC

This feature allows use of the text color specified in Text Manager. Click this button to use the text color specified in Text Manager. The **TMC** button appears on the Color Palette only if the **Use Text Manager** check box is selected.

● Color Palette Types

The type of color palette shown varies based on the series being used.

■ 256 Color Palette*¹

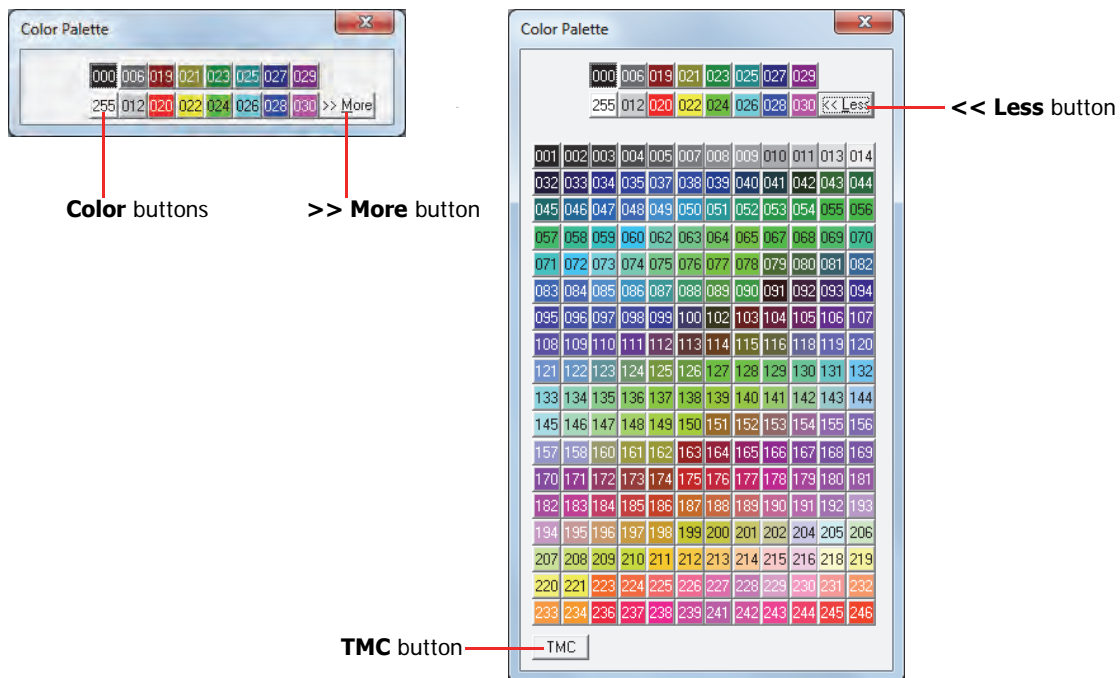

■ 8 shades Monochrome Palette*²

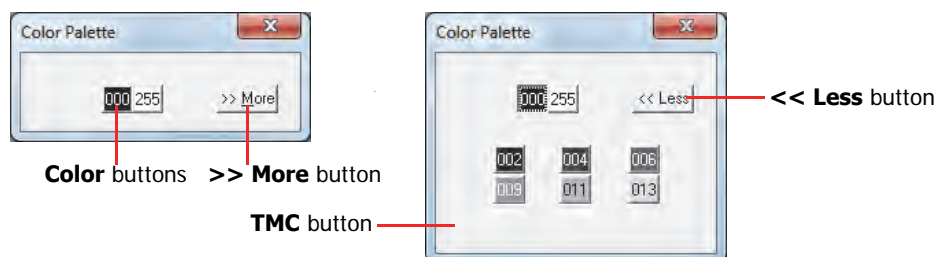

*1 Color LCD models only

*2 Monochrome LCD models only

4 Pattern Palette

The Pattern Palette is used to select patterns for drawing objects, part outlines, flanges, and other objects.

The Pattern Palette appears when you click on the **Pattern** button in the object's Properties dialog box. Click the **Pattern** button and select a pattern.

Drawings



Parts

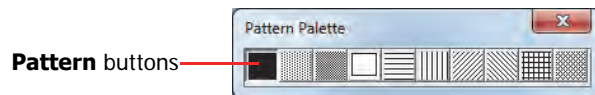

● Foreground and Background Colors

Drawing objects, part outlines and flanges are formed by foreground and background colors. The selected pattern is applied to the foreground color.

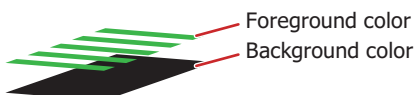

The background color is visible through the unpainted parts of the foreground color.



● Patterns

These patterns are available on WindO/I-NV3.

Pattern name	None *1	Foreground 100%	Foreground 25%	Foreground 50%	Background 100%	
Pattern buttons						
Display sample						
Pattern name	Horizontal lines	Vertical lines	Slant Upwards	Slant Downwards	Crosshatch	Tint
Pattern buttons						
Display sample						

*1 **None** can only be applied to drawing objects. Selecting **None** is the same as not applying any color at all.

5 Text Alignment

Text Alignment is used to adjust the way text appears on Drawing Objects and Parts.

● Horizontal Writing

These examples show how text appears using different combinations of the **Align Text Horizontal** and **Align Text Vertical** properties.

		Align Text Horizontal			
		Left	Center	Right	Center-Left
Align Text Vertical	Top				---
	Center (Center-Top)				
	Bottom				---

■ Align Text Vertical

Top: Aligns the text along the top edge.

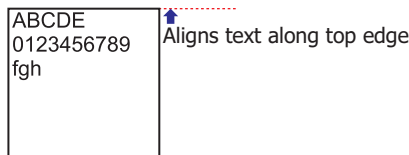

Center (Center-Top): Centers the text vertically in the center.

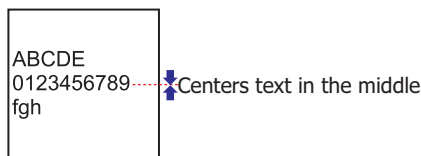

Bottom: Aligns the text along the bottom edge.

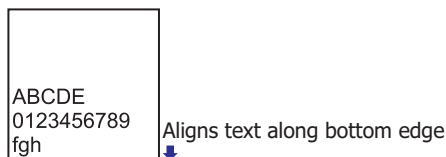

■ **Align Text Horizontal**

Left: Aligns the text along the left edge.

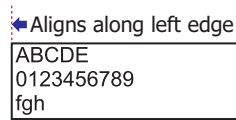

Center: Centers the text horizontally in the center.

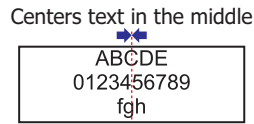

Right: Aligns the text along the right edge.

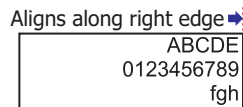

Center-Left: Centers the line containing the most number of characters, and then aligns the other lines to the left end of that line.

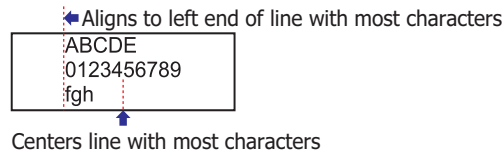

If **Align Text Horizontal** is set to **Center-Left**, **Align Text Vertical** will automatically be set to **Center-Top**. **Center-Top** results in the same display as **Center**.

● **Vertical Writing**

These examples show how text appears for **Align Text Horizontal**.

Align Text Vertical defaults to **Top**.

		Align Text Horizontal		
		Left	Center	Right
Align Text Vertical	Top	<pre>f 0 A g 1 B h 2 C 3 D 4 E 5 6 7 8 9</pre>	<pre>f 0 A g 1 B h 2 C 3 D 4 E 5 6 7 8 9</pre>	<pre>f 0 A g 1 B h 2 C 3 D 4 E 5 6 7 8 9</pre>

■ **Align Text Horizontal**

Left: Aligns the text along the left edge.

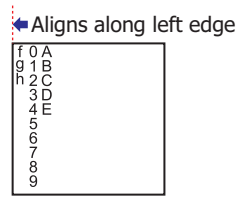

Center: Centers the text horizontally in the center.

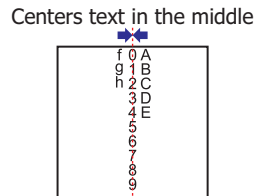

Right: Aligns the text along the right edge.

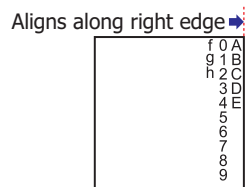

Take note of these points when the **Vertical Writing** check box is selected:

- When there is a mixture of double-byte and single-byte characters, the half-width characters are left aligned.

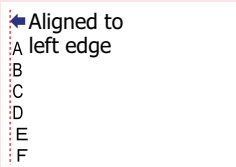

- Dashes are displayed horizontally. Symbols representing voiced and semi-voiced sounds of single-byte characters are shown as follows.

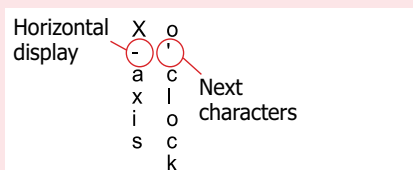

6 Ladder Program

This section describes details on ladder program processing, instruction execution times, and the byte count for instructions.

6.1 Processing in One Scan

While the Touch is running, the Touch performs operations repeatedly such as input refreshing, ladder program processing, and error checking. A *scan* is the execution of all instructions from the first line of the ladder program to the END instruction. The time required for this execution is referred to as one *scan* time. The scan time varies with respect to program length.

The current value of the scan time is stored to special data register D8023 (scan time current value), and the maximum value of the scan time is stored to special data register D8024 (scan time maximum value).

6.2 Executing Program Instructions

During the scan time, the ladder program is executed sequentially from the top to the bottom except when interrupt programs are executed. One scan time of a ladder program is approximately equal to the total of execution time of each instruction.

For the instruction execution times, refer to "6.4 Execution Times for Instructions" on page A-9.



When the processing time for one scan exceeds the specified time, a watch dog timer error occurs and the system is reset. For details on the watchdog timer, refer to Chapter 3 "4.17 Watchdog Timer Setting" on page 3-98.

6.3 Breakdown of END Processing Time

With the Touch, processing that occurs outside ladder program processing is referred to as END processing. This includes the processing for I/O refreshing and error checking.

Item	END Processing Time
Housekeeping (built-in I/O service)	5 msec min.

6.4 Execution Times for Instructions

Instruction	Device and Condition	Execution Time (μs)
LOD, LODN	—	1.58
	Using data register	2.71
OUT, OUTN	—	1.13
	Using data register	2.17
SET, RST	—	1.08
	Using data register	2.17
AND, ANDN, OR, ORN	—	0.81
	Using data register	2.46
AND·LOD, OR·LOD	—	0.85
BPS	—	0.99
BRD	—	0.99
BPP	—	0.99
SOTU, SOTD	—	2.16
TML, TIM, TMH, TMS	—	5.45
TMLO, TIMO, TMHO, TMSO	—	5.45
CNT, CDP, CUD	—	4.33
CNTD, CDPD, CUDD	—	126.1
SFR, SFRN	N bits	42.7+0.4n
CC=, CC≥	—	2.38
DC=, DC≥	—	2.94
MCS, MCR, JMP, JEND	—	—
END	—	—
NOP	—	—
MOV, MOVN (W, I)	M→M	44.7
	D→D	4.3
MOV, MOVN (D, L)	M→M	84.5
	D→D	84.5
MOV (F)	—	84.5
IMOV, IMOVN (W)	M+D→M+D	48.4
	D+D→D+D	7.7
IMOV, IMOVN (D)	D+D→D+D	87.9
IMOV (F)	—	87.9
IBMV, IBMVN	M+D→M+D	47.5
	D+D→D+D	47.5
BMOV	D→D	90.3+1.4n
NSET (W, I)	D→D	1.8+2.5n
NSET (D, L)	D→D	1.8+83.0n
NSET (F)	D→D	1.8+83.0n
NRS (W, I)	D, D→D	16.5
NRS (D, L)	D, D→D	732.5
NRS (F)	D, D→D	732.5
XCHG	D↔D	5.1
TCCST (W)	D→T	4.81

Instruction	Device and Condition	Execution Time (μs)
TCCST (D)	D→T	85.5
CMP (=, <>, <, >, ≤, ≥) (W, I)	D↔D→M	47.0
CMP (=, <>, <, >, ≤, ≥) (D, L)	D↔D→M	127.5
CMP (=, <>, <, >, ≤, ≥) (F)	D↔D→M	127.5
ICMP (≥)	D↔D↔D→M	169.5
LC (=, <>, <, >, ≤, ≥) (W, I)	D↔D	5.0
LC (=, <>, <, >, ≤, ≥) (D, L)	D↔D	86.5
LC (=, <>, <, >, ≤, ≥) (F)	D↔D	86.5
ADD (W, I)	M+M→D	86.5
	D+D→D	47.3
ADD (D, L)	M+M→D	166.3
	D+D→D	167.3
ADD (F)	D+D→D	171.9
SUB (W, I)	M-M→D	86.5
	D-D→D	47.3
SUB (D, L)	M-M→D	166.3
	D-D→D	167.3
SUB (F)	D-D→D	171.9
MUL (W, I)	M×M→D	86.5
	D×D→D	47.3
MUL (D, L)	M×M→D	166.3
	D×D→D	167.3
MUL (F)	D×D→D	171.9
DIV (W, I)	M÷M→D	86.5
	D÷D→D	9.3
DIV (D, L)	M÷M→D	166.3
	D÷D→D	167.3
DIV (F)	D÷D→D	171.9
INC (W, I)	—	44.7
INC (D, L)	—	124.5
DEC (W, I)	—	44.7
DEC (D, L)	—	124.5
ROOT (W)	\sqrt{D} →D	5.5
ROOT (D)	\sqrt{D} →D	86.7
ROOT (F)	\sqrt{D} →D	886.5
SUM (W, I)	D, D→D	47.6+1.1n
SUM (D, L)	D, D→D	90.5+41.5n
SUM (F)	D, D→D	90.5+45.0n
ANDW, ORW, XORW (W)	M·M→D,	46.1
	D·D→D	5.7
ANDW, ORW, XORW (D)	D·D→D	127.1
SFTL, SFTR	N_B=100	56.1
BCDLS	D→DS1=1	49.9
WSFT	D→D	91.3
ROTL, ROTR	D, bits=1	44.9
HTOB	D→D	10.5

Instruction	Device and Condition	Execution Time (μs)
BTOH	D→D	11.1
HTOA	D→D	13.7
ATOH	D→D	6.0
BTOA	D→D	13.7
ATOB	D→D	56.3
ENCO	M→Dbits=16	6.9
DECO	D→M	50.0
BCNT	M→Dbits=16	—
ALT	—	42.7
CVDT	W, I, D, L→F	53.0
	F→W, I, D, L	56.3
DTDV	D→D	8.9
DTCB	D→D	10.4
SWAP (W)	—	8.9
SWAP (D)	—	89.7
WEEK	—	—
YEAR	—	—
LABEL	—	—
LJMP	—	—
LCAL	—	—
LRET	—	—
DJNZ	—	—
IOREF	—	46.8
HSCRF	—	46.8
DI	—	90.3
EI	—	54.1
XYFS	—	—
CVXTY	—	—
CVYTX	—	—
AVRG (W, I)	S3=10	6.38
AVRG (D, L)	S3=10	49.5
AVRG (F)	S3=10	55.1
DTML, DTIM, DTMH	—	60.2
DTMS	—	63.0
TTIM	—	60.3
RAD	F→F	143.9
DEG	F→F	143.9
SIN, COS	F→F	161.1
TAN	F→F	149.1
ASIN, ACOS	F→F	618.9
ATAN	F→F	616.5
LOGE, LOG10	F→F	206.0
EXP	F→F	172.5
POW	F→F	191.0
FIFO	—	129.0
FIEX	—	129.0

Instruction	Device and Condition	Execution Time (μs)
FOEX	—	129.0
NDSRC (W, I)	D, D, D→D	19.5
NDSRC (D, L)	D, D, D→D	782.5
NDSRC (F)	D, D, D→D	782.5
TADD	—	54.4
TSUB	—	54.4
HOUR	D→D, Y, D	20.6
HTOS	—	52.7
STOH	D→D	92.1
SCRPT	—	*1
PID	—	—

*1 The SCRPT instruction execution time is stored in D1+1 after the instruction is executed.

6.5 Instruction Bytes

The quantities of bytes of basic and advanced instructions are listed below.

● Basic Instruction

Basic Instruction	Qty of Bytes	
	When not using data registers	Using data registers
LOD	4	8
LODN	4	8
OUT	4	8
OUTN	4	8
SET	4	8
RST	4	8
AND	4	8
ANDN	4	8
OR	4	8
ORN	4	8
AND-LOD	4	—
OR-LOD	4	—
BPS	4	—
BRD	4	—
BPP	4	—
SOTU	4	—
SOTD	4	—
TML	8	—
TIM	8	—
TMH	8	—
TMS	8	—

Basic Instruction	Qty of Bytes	
	When not using data registers	Using data registers
TMLO	8	—
TIMO	8	—
TMHO	8	—
TMSO	8	—
CNT	8	—
CDP	8	—
CUD	8	—
CNTD	8	—
CDPD	8	—
CUDD	8	—
SFR	8	—
SFRN	8	—
CC=	8	—
CC>=	8	—
DC=	8	—
DC>=	8	—
MCS	4	—
MCR	4	—
JMP	4	—
JEND	4	—
END	4	—

● Advanced Instruction

Advanced Instruction	Qty of Bytes
NOP	4
MOV, MOVN	12 to 16
IMOV, IMOVN	16
IBMV, IBMVN	16 to 24
BMOV	12 to 16
NSET	12 to 1,540
NRS	12 to 20
XCHG	12 to 16
TCCST	12 to 16
CMP (=, <>, <, >, <=, >=)	16 to 24
ICMP>=	16 to 28
LC (=, <>, <, >, <=, >=)	12 to 20
ADD, SUB, MUL, DIV	16 to 24
INC, DEC	8
ROOT	12 to 20
SUM	16 to 20
ANDW, ORW, XORW	16 to 24

Advanced Instruction	Qty of Bytes
SFTL, SFTR	12
BCDLS	12 to 16
WSFT	12 to 20
ROTL, ROTR	12
HTOB, BTOH	12 to 16
HTOA	12 to 20
ATOH	12 to 20
BTOA	12 to 20
ATOB	12 to 20
ENCO	12 to 16
DECO	12 to 16
BCNT	12 to 20
ALT	8
CVDT	12 to 20
DTDV	12 to 16
DTCB	12 to 16
SWAP	12 to 16

Advanced Instruction	Qty of Bytes
WEEK	20 to 532
YEAR	24 to 216
LABEL	8
LJMP	8 to 12
LCAL	8 to 12
LRET	8
DJNZ	12 to 16
IOREF	12
HSCRF	8
DI	8
EI	8
XYFS	20 to 268
CVXTY, CVYTX	16 to 20
AVRG	16 to 24
DTML, DTIM, DTMH, DTMS	16 to 20
TTIM	8 to 12
RAD	12 to 16
DEG	12 to 16
SIN	12 to 16
COS	12 to 16
TAN	12 to 16
ASIN	12 to 16
ACOS	12 to 16
ATAN	12 to 16
LOGE	12 to 16
LOG10	12 to 16
EXP	12 to 16
POW	12 to 24
FIFO	20 to 24
FIEX	12
FOEX	12
NDSRC	16 to 24
TADD	16 to 20
TSUB	16 to 20
HOUR	16 to 24
HTOS	12 to 16
STOH	12 to 16
SCRPT	12 to 16
PID	112

7 FBD Program

This section describes details on FBD program processing, FB execution time, and the byte count for FBs.

7.1 Processing in One Scan

While the Touch is running, the Touch continue to perform operations such as input refreshing, FBD program processing, and error checking. The execution of such a set of processing is defined as a *scan*. The time required for this execution is referred to as one *scan time*. The scan time varies depending on the created FBD program.

The current value of the scan time is stored to special data register D8023 (scan time current value), and the maximum value of the scan time is stored to special data register D8024 (scan time maximum value).

7.2 FBD Program Processing

In FBD programs, all of the FBs connected to the output FB (digital output FB or internal relay FB) are executed sequentially from the input FBs. The FBD program processing time in one scan is approximately equal to the total of execution time of each FB.

For the execution time of each FB, refer to “7.4 FB Execution Time” on page A-14.



If the processing time for one scan exceeds the specified time for the watchdog timer, a watchdog timer error occurs and the system is reset. For details on the watchdog timer, refer to Chapter 3 “4.17 Watchdog Timer Setting” on page 3-98.

7.3 Breakdown of Scan End Processing Time

After processing the FBD program, the Touch processes housekeeping operations at the end of each scan. It is referred to as Scan End processing. This includes the operations such as I/O refreshing and error checking.

Item	Processing Time
Scan End Processing	5 msec min.

7.4 FB Execution Time

Group	Name	Symbol	Device and Condition	Execution time (μsec)
Logical Operation	Logical AND	AND	—	73.0
	Negative Logical AND	NAND	—	73.2
	Logical OR	OR	—	73.2
	Negative Logical OR	NOR	—	73.0
	Exclusive Logical OR	XOR	—	72.6
	Negative Exclusive Logical OR	XNOR	—	72.8
	Negation	NOT	—	70.8
	Shot Up	SOTU	—	72.6
	Shot Down	SOTD	—	72.8
	Truth Table	TRUTH	—	73.4
Timer	On-delay Count Up Timer	TIMU	—	74.8
	On-delay Count Down Timer	TIMD	—	74.6
	Off-delay Count Up Timer	TIMOU	—	75.0
	Off-delay Count Down Timer	TIMOD	—	75.0
	On/off-delay Timer	TIMCU	—	77.4
	Single Shot Pulse	SPULS	—	74.8
	Dual Timer	DTIM	—	72.2
	Random Pulse Output	RPULS	—	95.2
Counter	Adding Counter	CNT	W (Word)	75.0
			D (Double word)	152.0
	Up/Down Selection Reversible Counter	CUD	W (Word)	75.6
			D (Double word)	126.8
	Hour Meter	HOUR	—	94.6
Shift Register	Shift Register	SFR	—	50.8
Data Comparison	Data Comparison	CMP	—	82.0
	Schmitt Trigger	STTG	—	79.8
	Range Comparison	RCMP	—	81.6
Data Conversion	Alternate Output	ALT	—	59.2
Week Programmer	Weekly Timer	WEEK	—	112.8
	Yearly Timer	YEAR	—	113.6
Script	Script	SCRPT	—	—
Special	High-speed Counter	HSC	—	159.0
	RS Flip-flop	RSFF	—	53.2

7.5 FBD Program Limitation

FBD programs have a limitations on the program size and the number of FBs. Even when the FBD program is less than the maximum size, FBs cannot be added to the FBD program if the number of used FBs is at the maximum.

The size of the FBD program is the total of the size of all FBs used in the FBD program.

The number of Block (B) is the number of FBs that use blocks (B) in the program. The number of Timer (T) and Counter (C) is the total of devices used in the timer FB and counter FB. These are not the number of timer FBs and counter FBs.

Maximum size of FBD program		38,000 bytes
Maximum number of blocks, timers, and counters that can be used in the FBD program	Block (B)	1,000
	Timer (T)	200
	Counter (C)	200



The timer FB, counter FB, and depending on the FB, multiple devices may be used. For details about each FB, refer to the description in the "SmartAXIS FBD Programming Manual".

● FB Size and Number of Used Devices

The size (quantities of bytes) and the number of used devices of FBs are listed below.

Group	Name	Symbol	Qty of Bytes	Device type	Number of Used devices
Logical Operation	Logical AND	AND	12	B	1
	Negative Logical AND	NAND	12		1
	Logical OR	OR	12		1
	Negative Logical OR	NOR	12		1
	Exclusive Logical OR	XOR	8		1
	Negative Exclusive Logical OR	XNOR	8		1
	Negation	NOT	8		1
	Shot Up	SOTU	8		1
	Shot Down	SOTD	8		1
	Truth Table	TRUTH	16		1
Timer	On-delay Count Up Timer	TIMU	8	T	1
	On-delay Count Down Timer	TIMD	8		1
	Off-delay Count Up Timer	TIMOU	12		1
	Off-delay Count Down Timer	TIMOD	12		1
	On/off-delay Timer	TIMCU	12		2
	Single Shot Pulse	SPULS	12		1
	Dual Timer	DTIM	12		3
	Random Pulse Output	RPULS	12		3
Counter	Adding Counter	CNT(W)	12	C	1
		CNT(D)	12		2
	Up/Down Selection Reversible Counter	CUD(W)	16		3
		CUD(D)	16		6
	Hour Meter	HOUR	12		3
Shift Register	Shift Register	SFR	16	B	1
Data Comparison	Data Comparison	CMP	16		1
	Schmitt Trigger	STTG	20		1
	Range Comparison	RCMP	20		1
Data Conversion	Alternate Output	ALT	12		1
Week Programmer	Weekly Timer*1	WEEK	20 to 130		1
	Yearly Timer*1	YEAR	24 to 212		1
Script	Script	SCRPT	12		1
Special	High-speed Counter	HSC	12		1
	RS Flip-flop	RSFF	8		1

*1 The size of the WEEK/YEAR FB varies depending on the number of tabs.

● FBD Program Examples

Example program 1

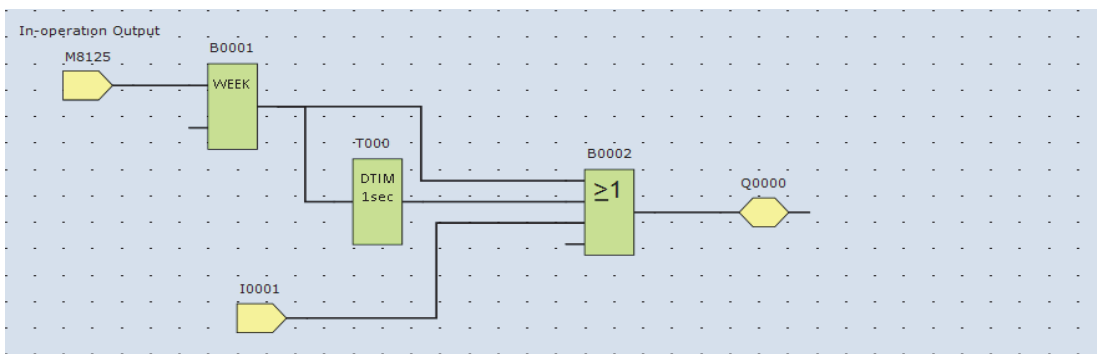

For example, in the above FBD program, the program size and the number of used devices can be calculated as described below.

Block number	FB		Size (Qty of Bytes)	Number of Used devices		
				Block (B)	Timer (T)	Counter (C)
M8125	SM	Special Internal Relay	Special internal relays, inputs, and outputs do not affect the FBD program size or the number of used devices.	1	0	0
I1	I	Input				
Q0	Q	Output				
B1	WEEK	Weekly Timer	24 (Number of tabs: 2)	1	0	0
T0	DTIM	Dual Timer	12	0	3	0
B2	OR	Logical OR	12	1	0	0
Total			48 (Program size)	2	3	0

Example program 2

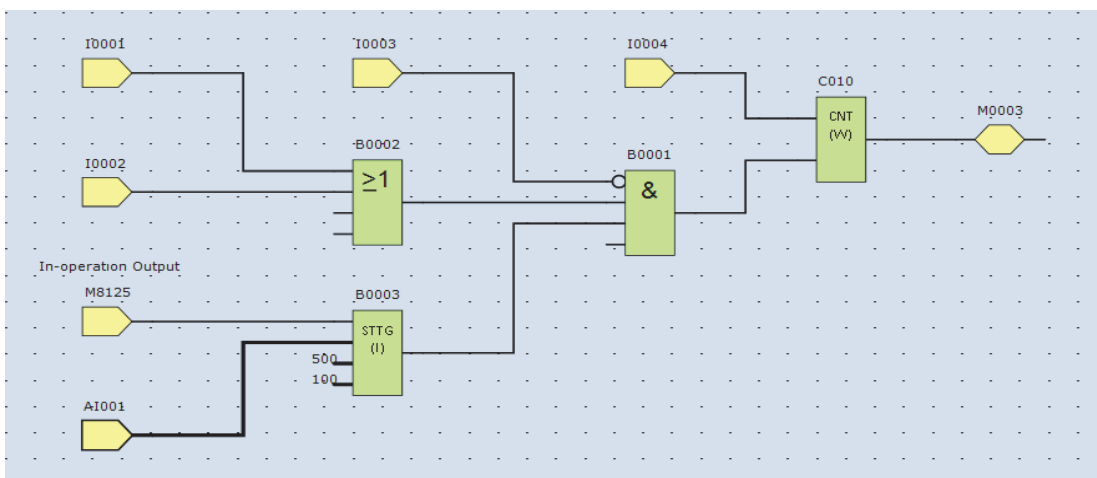

For example, in the above FBD program, the program size and the number of used devices can be calculated as described below.

Block number	FB		Size (Qty of Bytes)	Number of Used devices		
				Block (B)	Timer (T)	Counter (C)
I1	I	Input	Inputs, analog inputs, and internal relays do not affect the FBD program size or the number of used devices.	1	0	0
I2	I	Input				
I3	I	Input				
I4	I	Input				
AI1	AI	Analog Input				
M0003	M	Internal Relay				
B1	AND	Logical AND	12	1	0	0
B2	OR	Logical OR	12	1	0	0
B3	STTG(I)	Schmitt Trigger	20	1	0	0
C10	CNT(W)	Counter	12	0	0	1
Total			56 (Program size)	3	0	1

Index

Numerics

- 1:1 Communication 22-2, 22-4
- 1:N Communication 22-2, 22-5
- 256 Color Palette A-3
- 8 shades Monochrome Palette A-3

A

- Actions and Operations of Ladder Program and
 - FBD Program 12-1
- Active User 2-53
- Add 7-19, 7-22, 7-74, 11-10, 11-13, 11-36
- Adding a Security Group 21-15
- Additional fonts 23-15
- Address
 - Enable Increment Address 2-57
- Adjust Brightness Screen 28-2
- Adjust Contrast Screen 28-2
- Adjusting Screen Brightness 28-2
- Administrator 21-4
- Advanced Instruction 12-18, A-11
- Alarm Display 7-67
- Alarm List Display 7-65, 9-83
- Alarm Log Display 7-65, 9-99
- Alarm Log Function 13-1
- Alarm Log Settings dialog box 13-13
- Alarm States 13-3
- Alarm Tab 9-132
- Alternate 7-2, 7-5, 7-18, 7-22, 7-70
- Always Entry Mode 3-21
- Analog Cartridge 3-88, 29-29
- Analog Input 3-81
- Analog Output 3-86
- AND 7-19, 7-22, 7-74, 11-10, 11-13, 11-36
- Application Menu 2-37
- Arc 6-13
- Arithmetic Formulas 9-18, 9-126
- Arithmetic operation 20-16
- Arithmetic Operators 20-15, 20-31
- Arrange 2-48
- Auto Backlight OFF 3-19
- Auto-change IME 2-57
- Automation Organizer Updater dialog box 2-34
- Autorun Tab 3-41
- Auto-Setup dialog box
 - Alarm Log Settings 13-18
 - Data Log Settings 14-21
- Available Data 2-1
 - FBD program 12-45
 - Ladder program 12-29
- Available Updates 2-34

B

- Background Colors A-4
- Backlight color 4-15
- Backlight OFF 4-16
- Bar Chart 10-1
- Base Screen 4-14
- Basic Instruction 12-14, A-11
- Batch
 - Alarm Log Function 13-6
 - Alarm Log Settings 13-21
 - Data Log Settings 14-17
 - Data Structure and Output Example (Alarm Log Settings) 13-32
 - Data Structure and Output Example (Data Log Settings) 14-37
 - Data Structure and Output Example (Operation Log Settings) 15-17
 - Operation Log Settings 15-15
- Batch Monitor 24-14
- Bit Button 7-1
- Bit Devices 27-1
- Bit Functions 20-16, 20-34
- Bit Number Symbol 2-57
- Bit operator 20-16
- Bit Write Command 11-1
- Bitwise Operators 20-32
- Blink 4-16
- Blinking Cycle 3-22
- Block Settings 13-18
- Block Tab 18-10
- Breakdown of END Processing Time A-8
- Breakdown of Scan End Processing Time A-13

C

- Calendar 9-129
- Catch Input 3-72
- Change User Account Dialog Box 21-32
- Changing the Name of a Security Group 21-16
- Channel Settings 13-19
- Channel Tab
 - Alarm Log Settings 13-16
 - Recipe Settings 18-12
- Character Code Table 2-14
- Character Input 9-23
- Character Input Keypad 7-63
- Character string operation 20-18
- Charts 10-1

Data Settings Dialog Box	14-21, 22-36
Data Size	2-53
Data Storage Amount	
Alarm Log Function	13-7
Data Log Function	14-6
Operation Log Function	15-6
Data Storage Area	16-1
Data Storage Area Management dialog box	16-4
Data Tab	
Bar Chart	10-5
Data Log Settings	14-19
Recipe Settings	18-13
Data Transfer	1-6, 7-66
Data Transfer Function	25-1
Data type conversion	20-17
Daylight Savings Time	3-100
Debugging in WindO/I-NV3	24-4
Default Gateway	3-29
Default Path	2-58
Deleting a Security Group	21-17
Deleting a User Account	21-14
Deleting Data	
Alarm Log Function	13-8
Data Log Function	14-6
Operation Log Function	15-6
Deleting Data from an External Memory Inserted in the Touch	23-24
Deleting Files on the USB Flash Drive	26-13
Deleting Library Screens	4-33
Deleting Recipe Files	18-22
Deleting Screens	4-10
Device Address	
Maximum Number of External Devices	3-108, 4-28
Device Address Settings	2-61
Device cache	20-52
Device Display	10-22
Device Monitor	24-19
Disable Switch	3-22
Display Block No.	9-110
Display side by side	2-52
Display the Order of Overlapping Screens	4-16
Display the Value of Device in Popup	24-16
Display with Arithmetic Operation	9-18, 9-126
Div	7-19, 7-22, 7-74, 11-10, 11-13, 11-36
DM Link Communication	22-4
Docking	2-49
Download	3-108
Download Data	23-13
Download Dialog Box	23-13
Downloading	23-11
Downloading files	
Downloader	26-6
USB flash drive	26-4

Downloading Files to an External Memory Inserted in the Touch	23-16
Downloading Project Data	
USB flash drive	26-7
Downloading Project Data to the Touch	23-11
Downloading Project Files	25-5
Draw	20-19
Drawing Objects	5-2
Drawings	2-41, 5-1, 6-1
Duplicating Screens	4-8

E

Editing	2-43
Editing a User Account	21-12
Editing Recipe Data	18-14
Editing Recipe Files	18-21
Ellipse	6-10
Enable Low Battery Warning	3-20
Enable Maintenance	3-20
Enable Two-point Push	3-20
ENT button	9-6, 9-7, 9-27
Enter Password Dialog Box	21-38
Equilateral Polygons	6-18
Error Information	30-3
Error Messages	30-1
Errors Displayed on the Screen	30-1
Ethernet	3-29, 3-30, 23-6
Event Name	15-13
Example of User Communication Settings	22-68
Executing and Stopping Ladder Programs or FBD Programs	12-3
Executing commands using the USB Autorun function	26-19
Executing Program Instructions	A-8
Execution Times for Instructions	A-9
Exit WindLDR	
FBD Program	12-39
Ladder Program	12-13
Exporting Library Screens	4-34
External Device Monitor	24-15
External Memory	23-6
External Memory Devices	26-1
External Memory Information Dialog Box	23-30
External Memory Tab	
Alarm Log Settings	13-20
Data Log Settings	14-16
Operation Log Settings	15-14
Project Settings	3-40

F

FB Execution Time	A-14
FB Reference	12-40
FB Size and Number of Used Devices	A-16

FBD Program	12-32, A-13
FBD Program Examples	A-17
FBD Program Limitation	A-15
FBD Program Processing	A-13
File structure	
USB flash drive	26-2
Fill	6-21
Floating windows	2-49
Focus Order	4-16, 4-24
Font Assignment	2-59
Font Information Dialog Box	23-30
Font Size	2-8
Fonts installed in the Touch	2-5
Foreground Colors	A-4
Format	23-26
Arrange	2-48
Shape Style	2-47
Size	2-48
Text Style	2-47
Format List	20-14
Format Tab	
Alarm List Display	9-91
Alarm Log Display	9-107
Calendar	9-136
Character Input	9-30
Message Display	9-60
Message Switching Display	9-78
Numerical Display	9-120
Numerical Input	9-10
Selector Switch	7-103
Formatting an External Memory Inserted in the Touch	23-26
Formatting the USB Flash Drive	26-14
Frequency Measurement	3-77
Function	20-16
Function Area Settings	3-46
Function List	3-45, 20-10
Functions that Support Text Groups	19-2

G

General Error Codes	30-3
General Tab	
Alarm List Display	9-85
Alarm Log Display	9-101
Alarm Log Settings	13-13
Bar Chart	10-3
Base Screen	4-14
Bit Button	7-4
Bit Write Command	11-4
Calendar	9-131
Change User Account	21-32
Character Input	9-25
Data Log Settings	14-14
Global Script	20-12
Goto Screen Button	7-37
Goto Screen Command	11-20

Key Button	7-51
Line Chart	10-21
Message Display	9-56
Message Switching Display	9-72
Meter	10-50
Multi-Button	7-70
Multi-Command	11-33
Multi-State Lamp	8-16
New User Account	21-32
Numerical Display	9-116
Numerical Input	9-3
Operation Log Settings	15-10
Picture Display	9-43
Pie Chart	10-41
Pilot Lamp	8-3
Popup Screen	4-22
Potentiometer	7-111
Script Command	11-27
Selector Switch	7-96
Timer	11-48
User Accounts	21-30
Word Button	7-21
Word Write Command	11-12
Global Script	20-12
Goto Screen Button	7-35
Goto Screen Command	11-18
Gridlines	
Grid Settings	2-54
Show/Hide	2-46
Snap to Grid	2-53
Group Membership Tab	
Change User Account	21-33
New User Account	21-33

H

Halt and exit	20-15
Handling Problems	30-6
Highlighting Objects While Satisfying Conditions	24-16
High-quality Fonts	2-9
High-Speed Counter	3-55
HMI Device Addresses	
Bit Devices	27-1
Word Devices	27-9
Home	2-41
Horizontal Writing	A-5

I

I/O Refresh Timing	12-46
Image Files	2-18
Image Name	2-60
Importing Library Screens	4-35
Importing Text from a Text List	19-8
Importing user communication protocol	22-20
Indirect read	2-4
Indirect write	2-4

Individual Settings Dialog Box	
Alarm List Display	9-88
Alarm Log Settings	13-18
Data Log Settings	14-14
Preventive Maintenance Settings	17-8
Recipe Settings	18-10
Input FB	12-40
Input Filter	3-79
Input with Arithmetic Operation	9-18
Installed Fonts in the Touch	2-6
Instruction Bytes	A-11
Instructions Reference	12-14
Interface Configuration	3-27
Interface Settings	3-28
Internal Device	27-1
Interrupt Input	3-74
IP Address	3-29
Default	23-6, 23-7
IP Address Manager	23-10

K

Keep data error	30-4
Keep data sum check error	30-3
Key Browser	7-66
Key Button	7-49, 25-5
For Alarm Displays	7-65
For Data Transfer Keys	7-65
For Keypad	7-63
Keypad	7-66, 7-90

L

Label of Recorded Data	15-12
Ladder Monitor	3-97, 24-23
Ladder Program	12-4, A-8
Library Screens	4-29
Library Tab	3-11
Line	6-1
Line Chart	10-19
List Tab	9-87
Log Tab	9-103
Log Trend	10-21, 10-22
Logical Operation FB	12-41
Logical Operators	20-15, 20-30
Low Battery Voltage	30-2

M

Maintenance Screen	28-1
Master IP Address	23-9
Master Receive Timeout	12-46
Maximum Number of Parts	4-27
Message Display	9-53
Message Switching Display	9-70

Message Tab	9-74
Meter	10-48
Minimize the Ribbon	2-40
Minimum System Requirements	2-1
Mod	7-19, 7-22, 7-74, 11-10, 11-13, 11-36
Mode	2-53
Momentary	7-2, 7-5, 7-18, 7-22, 7-70, 11-1, 11-4, 11-10, 11-12
Monitor Function	24-1
Monitor Mode	1-6
Monitor Operation	
FBD Program	12-38
Ladder Program	12-12
Monitoring on the Touch	24-18
Monitoring with WindO/I-NV3	24-1
Monitors	2-45
Move	7-2, 7-5, 7-18, 7-21, 7-73, 7-74, 11-2, 11-5, 11-10, 11-12, 11-35, 11-36
Multi	7-19, 7-22, 7-74, 11-10, 11-13, 11-36
Multi-Button	7-68, 25-5
Multi-Command	11-31, 25-5
Multi-State Lamps	8-14

N

New	4-30
New User Account Dialog Box	21-32
No External Devices	22-6
No Touch Sound	
Bit Button	7-15
Character Input	9-35
Goto Screen Button	7-47
Key Button	7-61
Multi-Button	7-88
Numerical Input	9-19
Potentiometer	7-117
Selector Switch	7-107
Word Button	7-33
No.	4-14, 4-22
Not Clear Completed Device automatically	22-28
Notch Settings dialog box	7-100
Number of Blocks	
Alarm Log Settings	13-16
Recipe Settings	18-8
Number of I/Os	12-46
Numerical Display	9-114
Numerical Input	3-21, 9-1
Numerical Input Keypad	7-63

O

O/I Link Communication	22-3
O/I Link Slaves	23-5
O/I Link Tab	3-37
Object List	2-59

Occurred	13-3	Line Chart	10-29
Offset	20-20	Pen (Log) Tab	
Online	2-44	Line Chart	10-27
Online Function	23-1	Pen Recorder	10-22
Open Current Screens	24-17	Picture	5-2, 6-23
Opening Project Data	3-4	Picture Display	9-40
Opening Screens	4-2	Picture Manager	2-26
Operating Modes	1-6	Picture Name Setting dialog box	2-32
Operation Count Tab	17-9	Picture Tab	3-10
Operation Log Function	15-1	Pie	6-15
Operation Log Settings dialog box	15-10	Pie Chart	10-39, 10-42
Operation Time Tab	17-8	Pilot Lamps	8-1
Operator	2-64, 20-15, 21-4	Plate Color	9-66
Options dialog box	23-15	PLC Link Communication	22-1
Options Tab		Polygon	6-5
Alarm List Display	9-94	Polyline	6-3
Alarm Log Display	9-109	Popup Screen	4-22
Alarm Log Settings	13-24	Port	23-6
Bar Chart	10-16	Position	2-53
Base Screen	4-15	Potentiometer	7-109
Bit Button	7-14	Power failure	30-3, 30-4
Calendar	9-139	Preference	2-34
Character Input	9-34	Preventive Maintenance Function	17-1
Data Log Settings	14-22	Preventive Maintenance Settings dialog box	17-6
Goto Screen Button	7-46	Preview	2-54
Key Button	7-60	Preview button	2-57
Line Chart	10-36	Print Tab	3-8
Message Display	9-65	Printing Project Data	3-7
Message Switching Display	9-80	Priority of the Operator	20-53
Meter	10-56	Processing in One Scan	
Multi-Button	7-87	FBD Program	A-13
Multi-State Lamp	8-23	Ladder Program	A-8
Numerical Display	9-125	Program (ROM) CRC error	30-4
Numerical Input	9-16	Program Execution Error	30-3, 30-4, 30-5
Picture Display	9-50	Program Syntax Error	30-3, 30-4
Pie Chart	10-45	Project	2-43, 3-108
Pilot Lamp	8-11	Project Data	3-1
Popup Screen	4-23	Project Data Transfer Procedures	25-1
Potentiometer	7-116	Project Details Tab	3-42
Selector Switch	7-106	Project Recovery dialog box	2-35
User Account	21-34	Project Settings	3-18, 3-19
Word Button	7-32	Project Settings dialog box	3-19
OR	7-19, 7-22, 7-74, 11-10, 11-13, 11-36	Project Transfer Function	25-1
Output FB	12-40	Properties dialog box	
Overlay	4-15	Alarm List Display	9-85
P		Alarm Log Display	9-101
Parts	2-42	Arc	6-14
Parts List	2-60	Bar Chart	10-3
Password Input	21-36	Bit Button	7-4
Password Screen	21-37	Bit Write Command	11-4
Pattern Palette	A-4	Bit Write for Multi-Functions	7-73, 11-35
Patterns	A-4	Calendar	9-131
Peak charts	10-3	Character Input	9-25
Pen (Device) Tab		Circle/Ellipse	6-11

Equilateral Polygons	6-19
Fill	6-22
Goto Screen Button	7-37
Goto Screen Command	11-20
Goto Screen for Multi-Functions	7-76, 11-38
Key Button	7-51
Key for Multi-Functions	7-78, 11-40
Keypad	7-92
Line	6-2
Line Chart	10-21
Message Display	9-56
Message Switching Display	9-72
Meter	10-50
Multi-Button	7-70
Multi-Command	11-33
Multi-State Lamp	8-16
Numerical Display	9-116
Numerical Input	9-3
Picture	6-24
Picture Display	9-43
Pie	6-16
Pie Chart	10-41
Pilot Lamp	8-3
Polygon	6-6
Polyline	6-4
Potentiometer	7-111
Rectangle	6-8
Script Command	11-27
Script for Multi-Functions	7-80, 11-42
Selector Switch	7-96
Text	6-26
Timer	11-48
Word Button	7-21
Word Write Command	11-12
Word Write for Multi-Functions	7-74, 11-36
Protect	2-44
Protecting Data	21-2
Protecting Displays and Operations	21-5
Protecting the Display of Parts	21-22
Protecting the Display of Screens	21-18
Protecting the Operation of Parts	21-26
Protocol Manager	22-21
Protocol Tab	3-12
Q	
Quick Access Toolbar	2-38
R	
Range Tab	10-54
Reader	21-4
Real Time	
Alarm Log Function	13-6
Alarm Log Settings	13-22
Data Log Settings	14-18
Data Structure and Output Example (Alarm Log Settings)	13-33
Data Structure and Output Example (Data Log Settings)	14-37
Data Structure and Output Example (Operation Log Settings)	15-17
Operation Log Settings	15-16
Receive (RXD) Command	
BCC (Block Check Code)	22-62
Constant (Character)	22-50
Constant (Hexadecimal)	22-51
Device	22-52
Registering Constant (Character)	22-57
Registering Constant (Hexadecimal)	22-59
Skip	22-65
Receiving Character Time Out	22-23
Receiving Time Out	22-31
Recipe Function	18-1
Recipe Settings dialog box	18-8
Recorded Events	15-3
Recovered	13-3
Rectangle	6-7
Reference Screen	9-94, 9-109
Registering Text	19-5
Registration Text Tab	
Bit Button	7-10
Goto Screen Button	7-42
Key Button	7-56
Multi-Button	7-83
Multi-State Lamp	8-20
Pilot Lamp	8-7
Word Button	7-28
Relational Operator	20-15
Relational Operators	20-28
Remote Host List	3-106
Remote I/O	12-46
Remote I/O Communication Memory Refresh Image ...	12-48
Remote I/O master	12-46, 12-48
Remote I/O slave	12-46, 12-48
Repeat	20-14
Reset	7-1, 7-4, 7-73, 11-1, 11-4, 11-35
Reset Input	3-49
Reusing Screens	4-12
Ribbon	2-41
Run Mode	1-6
Run/Stop Selection at Memory Backup Error	3-51
Run/Stop Selection at Power Up	3-52
Runtime system	23-15
RXD	22-27
S	
SAFETY PRECAUTIONS	P-1
Sampling Method	14-15
Save	3-5
Save As	3-6
Save option	2-58

Save Screen As	4-5	Shape Style	2-47
Save Screens	4-4	Shapes	5-2, 6-1
Saving a screen	4-4	Shift Register FB	12-43
Saving Data		Show Below the Ribbon	2-39
Alarm Log Function	13-7	Show script error	3-20
Data Log Function	14-6	Show/Hide	2-46
Operation Log Function	15-6	Size	2-48
Saving Data as a CSV File		Special Data Register	12-48
Alarm Log Function	13-32	Special FB	12-44
Data Log Function	14-37	Special Functions	3-45
Operation Log Function	15-17	Special Internal Relay	12-48
Saving drawing objects drawn on the editing screen	2-23	Specifications	2-1, 29-1
Saving graphic elements in Picture Manager	2-19	Stacked Bar Chart	10-41
Saving image files	2-19	Standard Keypad Popup Screen	4-26
Saving pictures as image files	2-25	Start Code	22-66
Saving Project Data	3-5	Start Part with synchronous	3-22
Saving Registered Text as a CSV File	19-7	Start Time	3-19
Saving registered user communication protocol as a file	22-19	Start WindLDR	
Scale Tab		FBD Program	12-32
Bar Chart	10-11	Ladder Program	12-4
Line Chart	10-32	State Settings dialog box	8-22
Meter	10-55	State Tab	8-21
Screen	4-1	Station No.	
Screen List	2-59	Enable Increment Station No.	2-57
Screen Monitor	24-6	Status Bar	2-53, 2-55
Screen No. Format	3-19	Status Device	22-29
Screen Number Restrictions	4-27	Stop Input	3-48
Screen Size	4-1	Storage Method of 32-bit Numerical Data	3-21
Screen Tab	3-9	Storage Method of String Data	3-21
Screen Type	4-14, 4-22	String Data Storage Method	9-38, 9-69
Screens	2-41, 2-47, 4-2	Sub	7-19, 7-22, 7-74, 11-10, 11-13, 11-36
Script	20-1	Subnet Mask	3-29
Script Coding Examples	20-22	Default	23-6, 23-7
Script Command	11-25	Superimpose	4-23
Script Definition Method	20-14	Supported Languages	2-5
Script Editor	20-8	Switching the Displayed Language by Value of Device ...	19-10
Script Error	20-4	Switching the Screen of the Touch	24-17
Script FB	12-44	Symbol Factory	2-29
Script Function	20-1	Symbol Options Dialog Box	2-30
Script Manager	20-7	System Area	3-23
Security Function	21-1	System Information	23-27
Security Group	4-17, 4-24, 21-4, 21-6, 26-26	System Language	3-21
Selecting graphic elements from Symbol Factory	2-21	System Mode	1-6, 28-3
Selector Switch	7-94	System Setup	2-44
Set	7-1, 7-4, 7-18, 7-21, 7-73, 7-74, 11-1, 11-4, 11-10, 11-12, 11-35, 11-36	System Tab	3-19
Set & Reset	7-73, 11-35		
Set ON & OFF Data	7-74, 11-36	T	
Set Slave No.	23-9	Tag Editor	2-62
Setting Conditional Expressions	2-63	Target	23-8
Setting the External Memory Folder	26-12	Target Information Dialog Box	23-29
Setting user communication for a communication interface	22-8	Target IP Address	23-8
		Target List	23-7

Target Slave	23-9
Temporary Device	20-21
Terminal Code	22-66
Text	5-2, 6-25
Text Alignment	A-5
Text Color	9-66
Text Group	2-53, 19-1
Text Group Settings Dialog Box	19-15
Text Manager	19-12
Text size	
Enable Text Auto Resizing	2-57
Text Style	2-47
The editing windows are displayed side by side	2-52
Threshold	17-3
TIM/CNT preset value sum check error	30-4
Time Out (min)	23-6
Timer	11-46
Timer FB	12-42
Timer Interrupt	3-84
Timer/Counter Preset Value Sum Check Error	30-3
TMC button	A-3
Toggle	7-2, 7-5, 7-73, 11-2, 11-5, 11-35
Top Page	28-3
Touch	2-44, 23-5, 29-1
Touch Panel Adjust	28-7
Touch Setup	28-1
Touch Sound	3-20
Touch switch	4-21
Transfer	2-44
Transmission (TXD) Command	
BCC (Block Check Code)	22-47
Constant (Character)	22-37
Constant (Hexadecimal)	22-38
Device	22-39
Registering Constant (Character)	22-43
Registering Constant (Hexadecimal)	22-45
Transmission Wait	22-31
Trigger Condition	2-63
Trigger Condition Settings	2-63
Trigger Condition Tab	
Bar Chart	10-13
Bit Button	7-12
Bit Write Command	11-6
Calendar	9-137
Character Input	9-32
Global Script	20-13
Goto Screen Button	7-44
Goto Screen Command	11-22
Key Button	7-58
Line Chart	10-34
Message Display	9-63
Multi-Button	7-85
Multi-Command	11-43
Numerical Display	9-123
Numerical Input	9-14

Picture Display	9-48
Pilot Lamp	8-9
Potentiometer	7-114
Script Command	11-28
Selector Switch	7-104
Timer	11-49
Word Button	7-30
Word Write Command	11-15
Troubleshooting	30-1
TXD	22-26
Type Number	2-53

U

Upload Dialog Box	23-21
Upload Project Data from the Touch	23-18
Uploading	23-18
Uploading data	
Downloader	26-6
USB flash drive	26-5
Uploading Project Data	
USB flash drive	26-9
Uploading Project Files	25-5
USB	23-6
USB Autorun Definition File	26-22
USB Autorun Function	3-41, 26-18
USB Autorun Function Security	26-26
USB Flash Drive	26-1
USB Interface	3-28
USB Popup Screen Function	26-15
USB1	3-31
USB2	3-31
Use Device Cache	3-22
Use Large Font	3-20
Use System Area	3-22
User Accounts	21-1
User Accounts Dialog Box	21-30
User Communication	22-7
User Communication Protocol Settings Dialog Box	22-23
User Communication Tab	3-38
Using a Library Screen	4-31
Using the online function for Ethernet communication	23-7
Using the online function with an O/I Link Slave via an O/I Link Master	23-8

V

Vertical Installation Restrictions	4-28
Vertical Writing	A-6
View	2-46
Screens	2-47
Show/Hide	2-46
Window	2-47
Workspace	2-46
Zoom	2-47

View Browser	A-2
View Tab	
Alarm List Display	9-89
Alarm Log Display	9-105
Bar Chart	10-7
Bit Button	7-8
Calendar	9-134
Character Input	9-28
Goto Screen Button	7-40
Key Button	7-54
Line Chart	10-25
Message Display	9-58
Message Switching Display	9-76
Meter	10-52
Multi-Button	7-81
Multi-State Lamp	8-18
Numerical Display	9-118
Numerical Input	9-8
Picture Display	9-46
Pie Chart	10-44
Pilot Lamp	8-5
Potentiometer	7-112
Selector Switch	7-101
Word Button	7-26

W

Watch Dog	3-22
Watchdog timer error	30-3, 30-4
Watchdog Timer Setting	3-98
Week Programmer FB	12-44
When a USB flash drive is inserted a popup window is automatically displayed.	26-15
WindO/I-NV3	2-1
WindO/I-NV3 Options dialog box	2-56
Window	2-47, 2-49
Windows Font	2-5, 2-12
Word Button	7-17
Word Devices	27-9
Word Functions	20-16, 20-35
Word Write Command	11-9
Work Environment	2-56
Workspace	2-46, 2-49, 2-57, 2-59
Write delay	20-52

X

XOR	7-19, 7-22, 7-74, 11-10, 11-13, 11-36
-----------	---------------------------------------

Z

Zoom	2-47, 2-55, 2-59
------------	------------------