

Providing optimal products and solutions that meet the needs of the times.

To respond to diverse and changing customer needs, IDEC provides a broad range of products and solutions centered on its control technology. We are committed to supporting the future of manufacturing and daily life by continuously providing new value through the use of core technologies we have innovated over many years.

Note: Amounts in U.S. dollars are calculated at the prevailing exchange rate as of March 31 in every fiscal year.
 Note: Exchange rate (1 U.S. dollar): FY2021(110.72)

Industrial Switches



Sales ratio
47%
 \$226 million

Industrial Switches Business P19



IDEC
APEM

Industrial Relays & Components

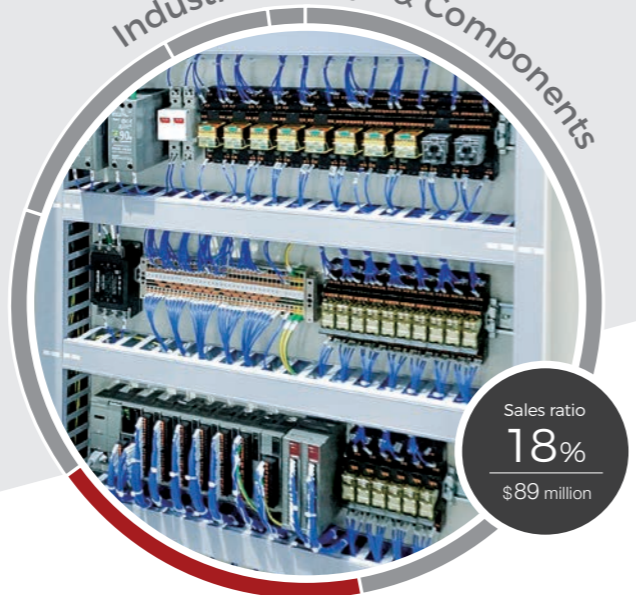

Sales ratio
18%
 \$89 million

Industrial Relays & Components Business P21

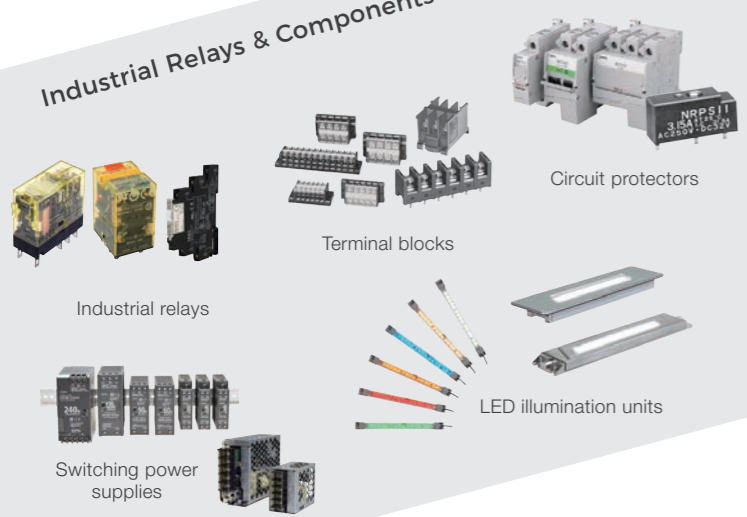

Automation & Sensing



Sales ratio
15%
 \$74 million

Automation Business P23



Sensing Business P23



Safety & Explosion Protection

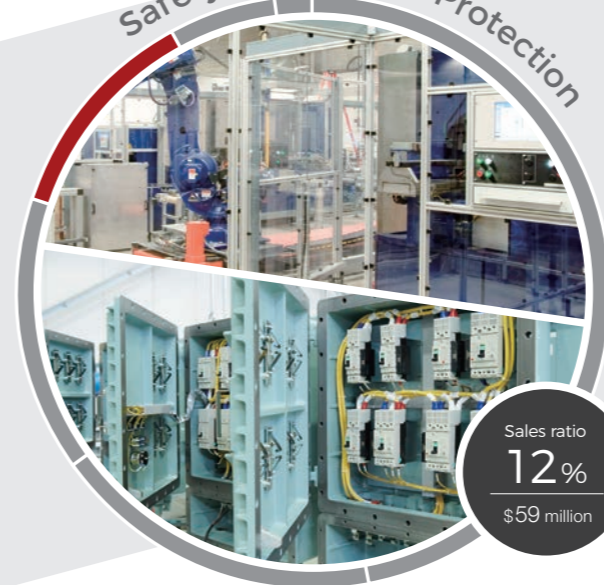

Sales ratio
12%
 \$59 million

Safety & Explosion Protection Business P25



New Business



Sales ratio
2%
 \$11 million

New Business P27



Industrial Switches

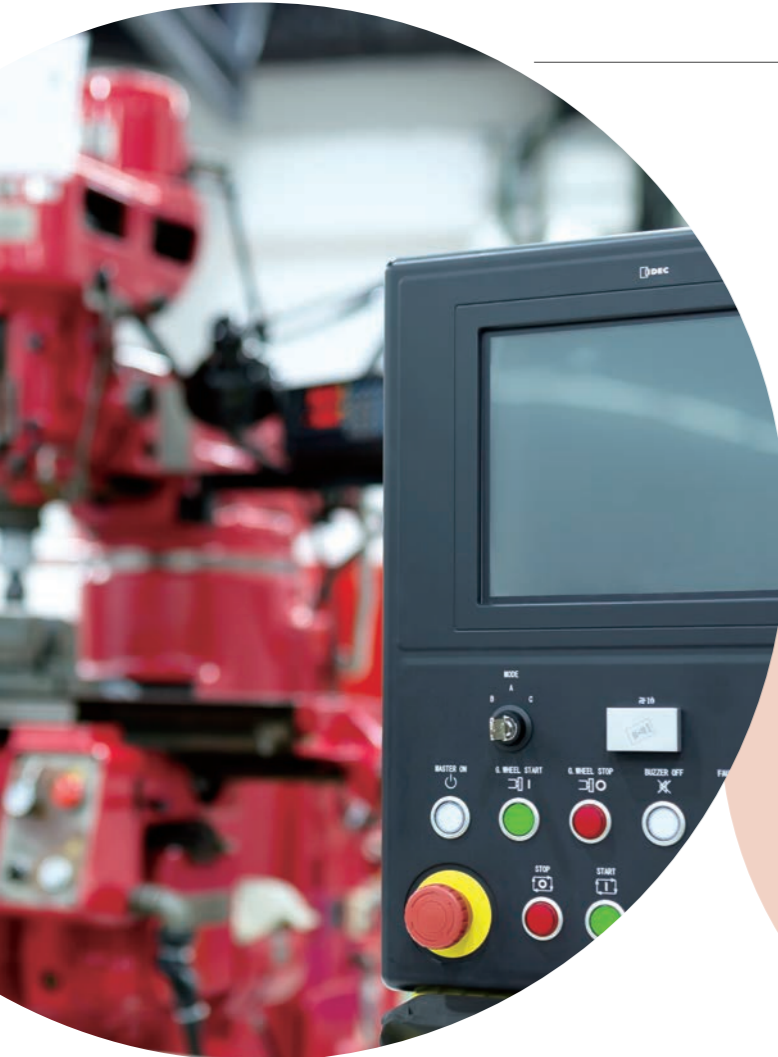

Creating an optimum environment for humans and machines as a leading company of industrial switches.

Leveraging our long-accumulated control technologies since foundation, the IDEC Group contributes to realizing safety, ANSHIN*, and well-being by providing innovative solutions worldwide, not only for the factory automation (FA) industry but also for familiar daily-life situations. With the aim of becoming the number one global company in industrial switches, the IDEC Group provides diverse solutions that bring together humans and machines. We do this through dedicated pursuit of quality, durability, and safety in our products, and through offering a product line-up that boasts versatility in design and ease of use.

*ANSHIN: a sense of trust and assurance without any fear or stress

Business overview for FY2021

In Asia Pacific, sales were firm due to a recovery in demand in China. In Japan, the Americas, and Europe, sales in each of these regions decreased as they were affected by the deterioration in business confidence and other factors. Since the second half of FY2021, however, market conditions has been on a gradual recovery trend.

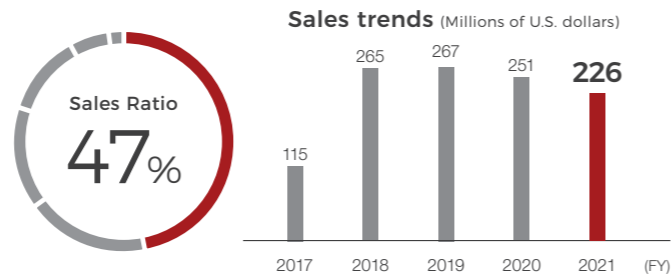

Note: Amounts in U.S. dollars are calculated at the prevailing exchange rate as of March 31 in every fiscal year.
 Note: Exchange rate (1 U.S. dollar): FY2017 (¥112.20), FY2018 (¥106.27), FY2019 (¥111.01), FY2020(¥108.83), FY2021(¥110.72)

TOPIC

KW2D smart RFID reader lets users manage user authority for machines and control traceability

Manufacturing sites nowadays face challenges of insufficient management of an increasingly diverse workforce and occurrence of troubles, such as workplace accidents, malfunctions of machines, and increase of defective products. There are heightened needs for establishing user authority for machines by individual authentication and for traceability of inspection history. We therefore launched the KW2D smart RFID reader in the global market in 2020. This device is capable to read not only existing employee ID cards and various other IC cards, as well as key fob tags, which are broadly used in Europe as a substitute for keys. It also manages user authority for machines and equipment, and tracks entry/exit at work areas, and controls traceability of manufacturing lines.



KW2D smart RFID reader

Main application venues

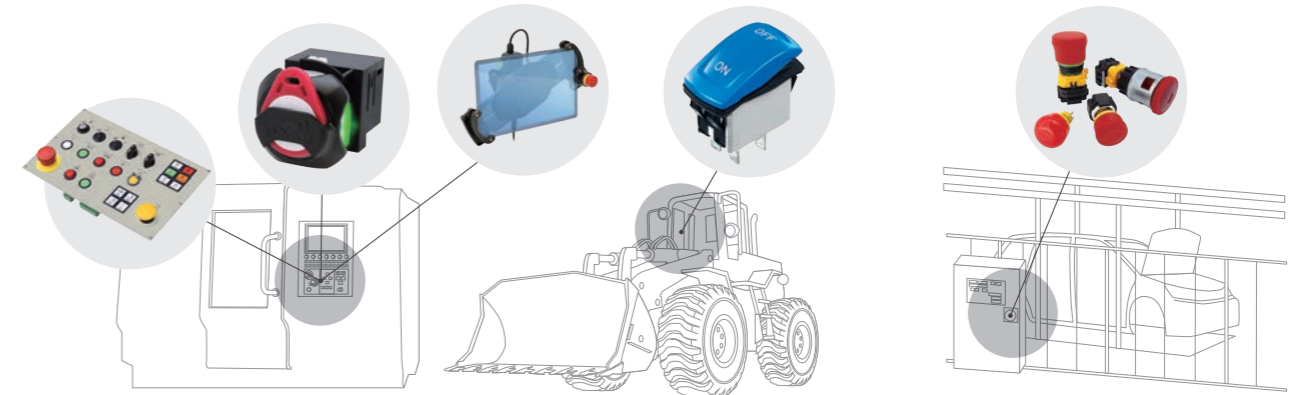

Stylish control panels for a variety of devices and special vehicles, and handy-type control devices that can attach a tablet

Emergency-stop switches for installation in manufacturing lines, which require high safety

Business strategy

Advancing as a global leader in industrial switches

Since 1958 when we began sales of industrial switches, we have developed diverse product line-up and continuously carried out design reviews and quality improvement. Such efforts have enabled us to acquire high market shares in Japan. In recent years, society's requirement for environments that assure safe, simple and smart work for a diversity of people has become stronger. Responding to this requirement, IDEC is engaged in enhancing a line-up of products that feature a push-in connection style — a wiring method that requires less wiring, less space, and provides greater reliability.

In 2017, the APEM Group of France joined the IDEC Group. This has enabled us to achieve a more optimal geographical portfolio. We are now promoting business expansion as both the IDEC Group and the APEM Group strive to complement each other in industries and regions of their strengths to expand sales, generate synergies in technology, and develop next-generation HMI (Human-Machine Interface) products. As a leading company in industrial switches, the IDEC Group is determined to create new products and solutions that respond to the needs of society and innovate the HMI environment for improvement in productivity of customers.

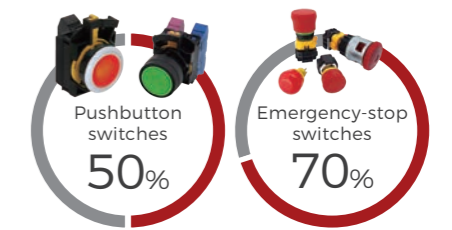

Major products market share in Japan(As of March 31, 2021)
 *Internal survey

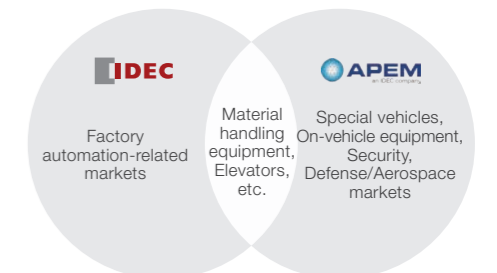

Major sales markets of IDEC and APEM

Add safety features to tablets on the manufacturing sites

High-function but cheap off-the-shelf tablets are now often used as control terminals or teaching pendants at manufacturing sites. From the standpoint of ISO/IEC safety standards, however, the tablets or other operation devices, which are used near sources of danger from machinery, need to be equipped with safety devices, such as an enabling switch and an emergency-stop switch. This has been an obstacle for further introduction of tablets at these sites. IDEC has therefore released the HT3P safety commander in the global market. This device can be easily attached to various off-the-shelf tablets. The tablets then can be used for control of manufacturing lines and equipment, robot teaching, and other applications, contributing to greater safety and convenience and cost reduction.



HT3P safety commander

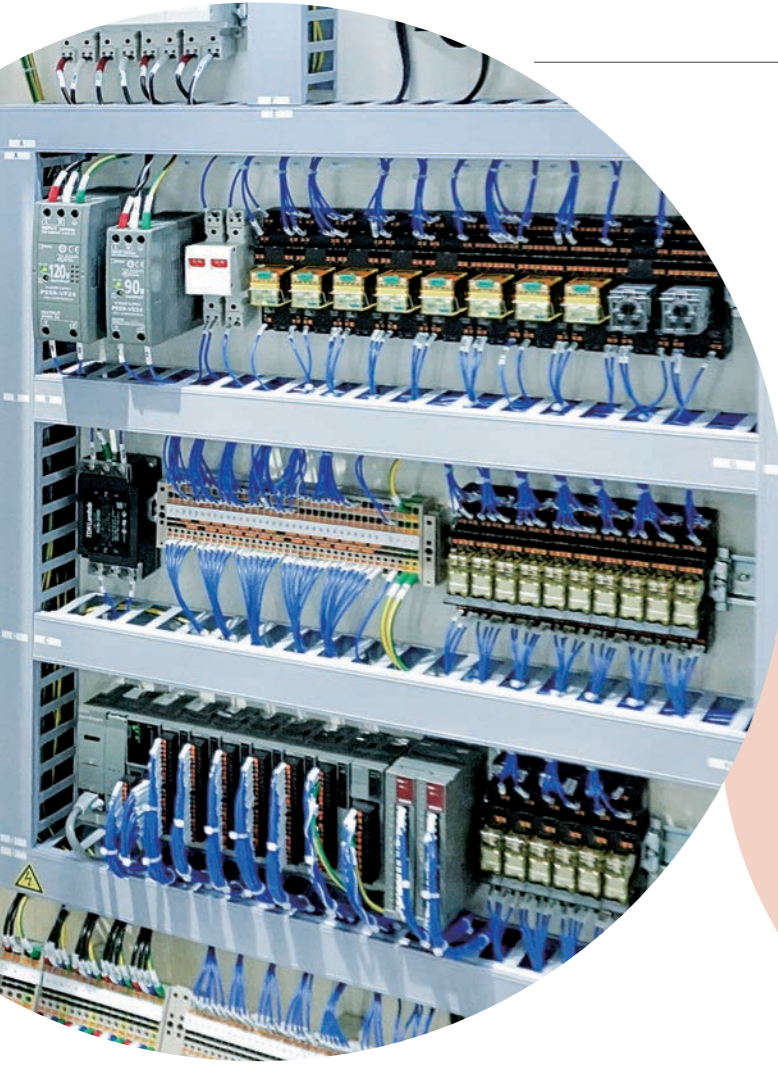

Industrial Relays & Components

Using a full line-up of products to help customers overcome challenges.

Industrial relays and components is a collective term for various electronic devices incorporated inside control panels and control boxes that are used in the operation and control of machinery and manufacturing lines. They are in use in a wide variety of settings, such as manufacturing sites, elevator controls and other equipment control of systems in buildings, automated warehouses, industrial machinery, and semiconductor manufacturing equipment. Responding to ever-growing needs for “smarter” facilities and equipment, space-saving, and quality stabilization, IDEC adds new technologies to various devices installed inside control panels, thereby providing more-efficient, highly-convenient, operator-friendly production environments, and assisting customers find solutions to various challenges.

Business overview for FY2021

Sales decreased, particularly in the Japan and Americas, because demand for capital investment decreased due to the spread of COVID-19. Meanwhile, sales of control relays in China remained firm.

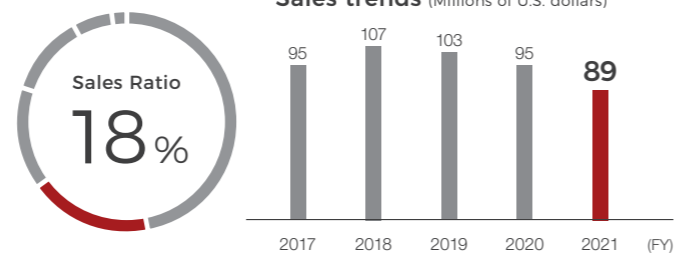

Note: Amounts in U.S. dollars are calculated at the prevailing exchange rate as of March 31 in every fiscal year.
Note: Exchange rate (1 U.S. dollar): FY2017 (¥112.20), FY2018 (¥106.27), FY2019 (¥111.01), FY2020(¥108.83), FY2021(¥110.72)

TOPIC

Expanded sales by strengthening combination terminal services

The BN series and other terminal blocks are delivered in a “combination terminal” attached to a DIN rail to improve on-site work efficiency. We will expand our sales by developing our range of products, including the push-in terminal block “A Series” and the fixed terminal block “BTB Series,” and delivering the product in a short delivery time.

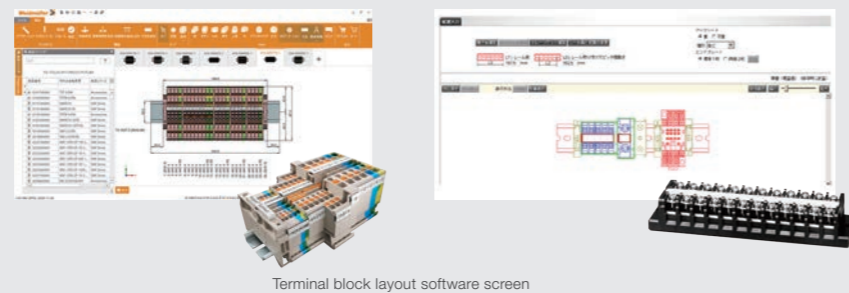

Main application venues

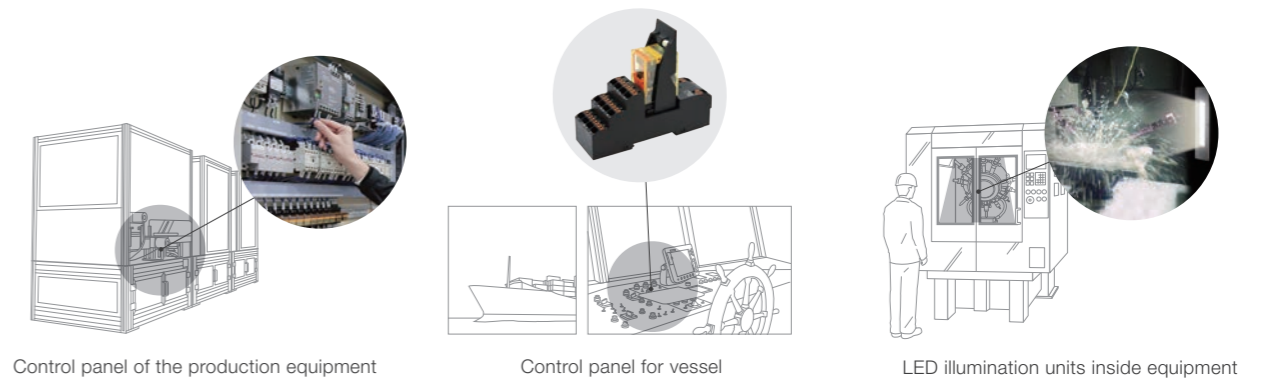

Control panel of the production equipment

Control panel for vessel

LED illumination units inside equipment

Business strategy

Small-size switching power supplies, best for the growing power supply market

Every device requires power. This includes a variety of new equipment and devices that help create a new, normal environment in the COVID-19 era, and IoT devices that enable plant monitoring and visibility of security of a remote location. We launched the “PS3V” switching power supply, which is ideal for being mounted in these equipment and devices, because of high thermal and noise resistance, high efficiency, and high degree of freedom in mounting locations. As this power supply meets various safety standards, we will expand sales by targeting FA applications in Japan and overseas, as well as freezers and refrigerators, and office equipment.

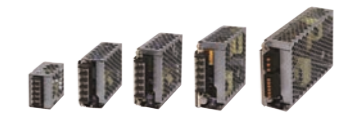

Application examples



Food storage equipment



Safety equipment at station platform

Expansion of push-in products and services

As well as expanding sales of the push-in products that realize the challenges of control panels to make it smaller and require less wiring and less man-hours, we are working to build a comprehensive support system. The system includes rental services of products, such as Ferrule automatic crimping machines, tool calibration services, and services that facilitate the introduction of push-in products using trial starter kits. In addition to conventional push-in products, the new smart RFID reader, safety relay module, and switching power supply are added. They contribute to society by reducing wiring work process, achieving stable wiring quality, and providing convenience without need of a more tightening work.

	FY2020	FY2021
Panel front Over 10,000 SKUs	HW Series, CW/YW Series	Smart RFID reader
Inside panel Over 3,000 SKUs	PLC, Relay sockets	Safety relay modules, Switching power supplies
Panel terminal blocks and peripheral devices Over 5,000 SKUs	Terminal blocks	Rental service; calibration service, Tools & ferrules

Expanding market share of LED illumination units that meet customer needs

We have developed the LF3D series of LED illumination units that are ideal for machine tools, by satisfying needs to reduce multiple shadows and reflections of lighting sources, improving visibility at hand. IDEC’s proprietary optical design, combined with optimal LED distribution, reduces multiple shadows and reflections, enabling checking for flaws or fine irregularities of what is being processed. In addition, contrast of luminance distribution light on the emitting surface has been improved by 85% from the previous model. The LF3D design provides equally brilliant light at the center or edges of the units and the glare saving mode that reduces glare to an operator is equipped as a standard feature. IDEC’s advanced technology has thus developed a product of high market importance.

LF3D Series	
Surface mounting type	Recessed mounting type
Reduce reflections of light source and multi shadows (patent pending)	

Automation & Sensing



Offering optimum solutions matching the era of IoT and Industry 4.0.

Along with a decline in Japan's working population and permeation of IoT, we see an increase in need to support remote monitoring and operations, and an increase in demand for key devices that promote work efficiency and automation. We have a diverse product line-up precisely related to that need and demand. IDEC solutions contribute to higher levels of automation and efficiency in manufacturing. These solutions include automation products, such as programmable logic controllers that control machinery, equipment, and assembly lines as well as operator interfaces that create more comfortable operating environments; and sensing products such as sensors that detect physical objects and changes in conditions, code readers and RFIDs with potential growth in demand for traceability application.

Business overview for FY2021

In Japan, in addition to a decrease in sales of the operator interfaces and programmable logic controllers, sales of automatic identification products such as barcode readers, which had increased demand before the consumption tax rate hike in 2019, decreased compared to the previous year. In the meantime, mainly due to the increase in demand for programmable logic controllers in Europe, overall sales in the automation business was strong.

Note: Amounts in U.S. dollars are calculated at the prevailing exchange rate as of March 31 in every fiscal year.
 Note: Exchange rate (1 U.S. dollar): FY2017 (¥112.20), FY2018 (¥106.27), FY2019 (¥111.01), FY2020(¥108.83), FY2021(¥110.72)

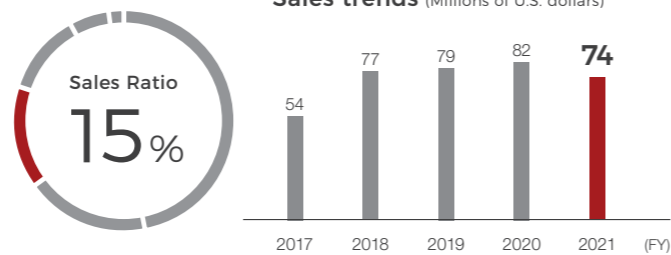

TOPIC

SA2E series miniature photoelectric switches enable detection of high-speed transmitted objects

Permeation of IoT has boosted demand for sensors in various industries but the conventional sensors could not detect high-speed transmitted small objects, unless suitably spaced apart from each other. The SA2E miniature photoelectric switches with built-in amplifiers, released in 2021, detect high-speed consecutively-transmitted small objects and halve a response time to 0.5ms maximum, compared to the previous model. The SA2E series also offer a line-up of products with different detection distance and detection methods, responding to diverse needs of customers, who can choose an optimal model for their application.



SA2E miniature photoelectric switches

Main application venues

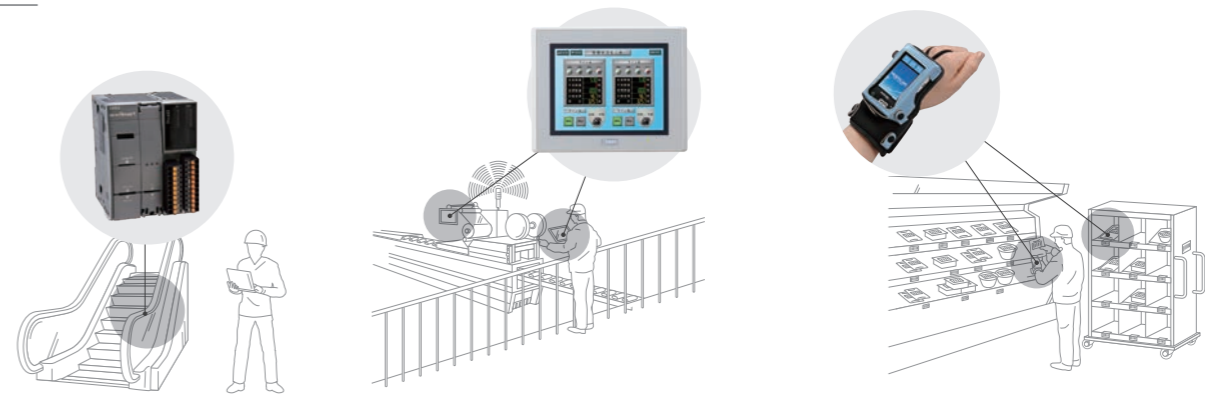

Programmable logic controllers and operator interfaces that enable remote monitoring and operation

Wearable terminals that improve worker efficiency

Business strategy

Addition of MQTT support enables direct transmission of data to a cloud server

We released an upgrade that enables existing MicroSmart FC6A Plus CPUs to support the industry-standard MQTT (Message Queuing Telemetry Transport) protocol in 2020. This is in response to users' needs to save collective data from various devices in a server for analysis and other use. MQTT has emerged as the preferred IoT communications protocol, but due to a limited number of the corresponding industrial controllers, communication devices or gateways that convert data to the MQTT protocol have been required for data transmission. As the FC6A Plus CPUs support the MQTT protocol, the programmable logic controller can directly communicate with a data collection server, enabling one unit to serve for control, sensing, and communication and easily responding to IoT needs.



MicroSmart FC6A Plus CPUs Programmable logic controller

IDEC solutions that make IoT real

We are enhancing optimum functions that are so important in our new all-connected era, facilitating use of IoT for programmable logic controllers, operator interfaces, sensors, code readers, etc. This is another way our solutions contribute to solving diverse challenges that our customers face.

Concept of IDEC's remote monitoring and operation system

Store data	Detect/measure data in need at the scene.
Transmit data	Transmit data to a server over the Internet.
Display data	See the status of the site on a PC or tablet in a remote location.
Send e-mail	Send an alert message in case of trouble.
Operate from a remote location	Change the settings of the site from a remote location. Parameters of sensors with IO-Link function can be changed.

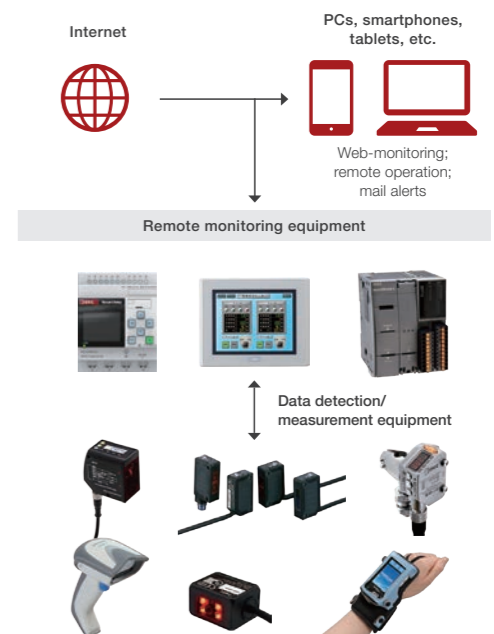



Safety & Explosion Protection

As a company that pursues and realizes world-class safety, ANSHIN*, and well-being, we provide solutions that enhance safety and productivity.

From the day the company was founded in 1945, we have strived to create safe environments for humans in their interaction with machines, and to that end we have developed many kinds of safety-related products and explosion protection products. We have spread and expanded Safety1.0 products that ensured safety by separation and operation pauses of machines. We have recently developed a next-generation safety philosophy "Collaborative Safety / Safety2.0" aimed at coordinating safety between humans and machines. In addition to proposing new safety equipment applications that use machine-origin information to keep humans out of harm's way, and to prevent dangerous control of machines by use of human-origin information, we promote safety in ways including creation of new standards and consulting.

*ANSHIN: a sense of trust and assurance without any fear or stress

Business overview for FY2021

Sales of some products, such as safety laser scanners, decreased due to a decline in global capital investment demand and the worsened business confidence. However, sales of safety-related products remained virtually flat, partly due to strong sales in China. Sales of explosion protection products decreased mainly in Japan.

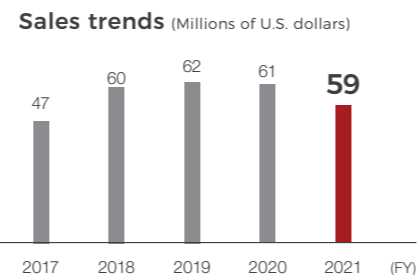

Note: Amounts in U.S. dollars are calculated at the prevailing exchange rate as of March 31 in every fiscal year.
 Note: Exchange rate (1 U.S. dollar): FY2017 (¥112.20), FY2018 (¥106.27), FY2019 (¥111.01), FY2020 (¥108.83), FY2021 (¥110.72)

TOPIC

Expanding a portfolio of explosion protection products

Explosion protection products, rather than ordinary control products, are indispensable to ensure safety in hazardous locations using flammable gas or liquid. By combining our strengths and knowledge in the development process, in 2019 the IDEC Group started supplying customers with explosion protection mat switches that are capable of presence detection and in 2020 added to that new product the HLL series explosion protection LED illumination units. They are highly environmentally resistant and well-suited for use where protection from explosion by gas, steam, or dust is desired. With the aim of further expanding business shares, we are promoting sales expansion of the EU2B series explosion protection control units, which obtained an international standard certification, IEC-Ex certification, and working at global development of our explosion protection products.



Main application venues

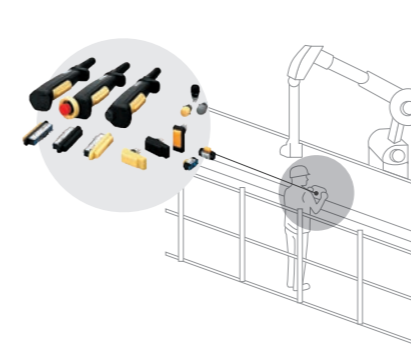

Enabling switches that ensure safety of manufacturing lines, etc.



Safety laser scanners that can detect the presence of humans and objects within an area

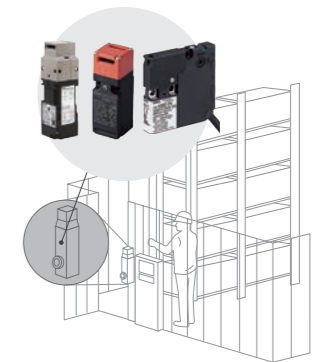

Interlock switches that can detect whether doors or safety fence gates are opened or closed

Business strategy

As a leading company in practicing "Collaborative Safety / Safety2.0"

Our definition of underlying concept of safety began with Safety0.0 that ensured safety by attentiveness and judgment of humans. Subsequently, Safety1.0 focused on applying safety measures to machines and ensuring safety by separation and operation suspension of machines. More recently, a collaborative concept of humans and machines in realizing both safety and productivity, Safety2.0, is being defined.

We aim at expanding business shares in safety-related products used in a wide range of applications: from interlock switches and enabling switches to safety laser scanners and safety relay modules. We strive to expand sale of Safety1.0 products that currently support workplaces. At the same time, for pursuit and realization of the next-generation safety philosophy "Collaborative Safety / Safety2.0", we are dedicated to development of innovative Safety2.0 products, such as wearable stop switches that enable the person to easily and swiftly operate equipment and to remotely stop the machine in an emergency.



Becoming a company that pursues and realizes world-class safety, ANSHIN, and well-being

"Collaborative Safety / Safety2.0" is a comprehensive approach that intended to improve safety and productivity from four aspects: technology development; human resources development; management; and social rule-making. Through collaborative technology development with other companies, development of Robot Safety Assessors and other professionals specializing in safety, participation in the "Vision Zero" campaign to improve "Safety, Health, Well-being" at work, and development of an international-standard handbook "Safety in the Future", we are creating and globally expanding a new trend in safety, ANSHIN, and well-being, overcoming barriers of different industries. We are also promoting initiatives aimed at business expansion in China, a market of huge potential demand. Since 2017, we have held technology exchange meetings with the Standardization Administration of China (SAC) and in 2020 we held safety seminars throughout China in the form of a webinar. We plan to develop safety-related products dedicated for demand in China.

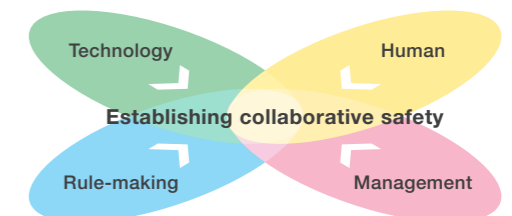

Safety seminars held in Shanghai



New Business

Contributing to resolving societal challenges through a variety of solutions utilizing control technologies.

The IDEC Group's new business segment is growing mainly by growth of two business lines: the collaborative safety robot system business led by IDEC FACTORY SOLUTIONS CORPORATION; and the environmental energy-related business led by IDEC SYSTEMS & CONTROLS CORPORATION.

Through these we are making group-wide efforts to tackle societal challenges, such as a labor shortage for industrial sites and climate change.

Business overview for FY2021

In Japan, sales in the environmental and energy-related business, including mega-solar and power management systems for solar power generation, have decreased significantly. In the meantime, the collaborative safety robot system business has increased the number of use cases for a wide range of companies, due to increased demand for automation and labor-saving. Sales were firm.

Note: Amounts in U.S. dollars are calculated at the prevailing exchange rate as of March 31 in every fiscal year.
 Note: Exchange rate (1 U.S. dollar): FY2017 (¥112.20), FY2018 (¥106.27), FY2019 (¥111.01), FY2020(¥108.83), FY2021(¥110.72)

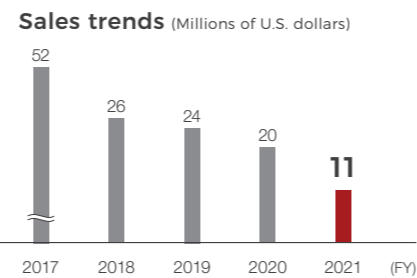

Business strategy

Collaborative safety robot system business

Evolving from a base in safety-related products and safety systems, which are among our strengths, we have created systems that combine various makers' collaborative robots, vision sensors, artificial intelligence (AI), and autonomous mobile robots (AMR), as well as diverse application packages, to satisfy customer needs.



Collaborative safety robot systems

Environmental energy-related business

By leveraging our long-cultivated control technologies and environmental technologies, we contribute to resolving globally-ongoing diverse societal challenges. Specific examples include contributions to self-generation of solar power and other renewable energy use; supply of electric power as part of business continuity plan (BCP) measures; and next-generation agricultural solutions. We have accumulated many solutions that have integrated one or more of these even to the extent of encompassing an entire supply chain from production to logistics and retail outlets.



Renewable energy



Corporate Social Responsibility (CSR) Activities

Integrated with Management

Based on our company philosophy "The IDEC Way", the IDEC Group Code of Conduct, CSR Charter, and the Ten Principles of the United Nations Global Compact are our important guidelines. We are committed to solving societal challenges through our business activities. Moreover, IDEC aims to enhance our value as a company that is needed in society by CSV (Creating Shared Value), a business concept to create value for both society and a company.



Through our business activities, we contribute to the Sustainable Development Goals (SDGs), set by the United Nations.

Information disclosure on the website

IDEC's CSR information is available on the corporate website.
https://us.idec.com/idec-us/en/USD/corporate_social_responsibility



CSR Promotion System

The CSR Committee, chaired by the CEO, has been established as a body to develop the CSR action policy of the IDEC Group. Under the CSR Committee, "ESG+Sa+Q" five specialized committees – Environment, Social, Governance, plus two areas of our strengths, Safety and Quality – were established, each in charge of promoting a particular area of CSR activities. Each specialized committee, chaired by an executive officer, consists of individuals with expertise and experience, and tackles measures according to their respective themes. Important issues discussed by the CSR Committee are reported to the Board of Directors meetings.

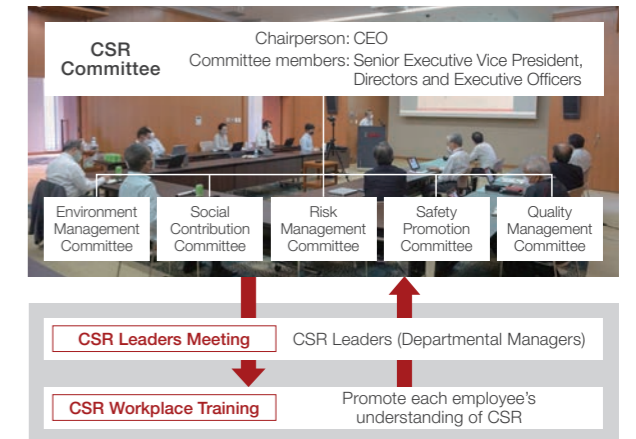

Each IDEC employee is involved in CSR activities

CSR Leaders share the contents of CSR Committee discussions with each employee at CSR Workplace Training sessions, aiming to "put CSR activities into practice" and "create an open workplace" where opinions can be exchanged. In FY2021 employees submitted 688 opinions and proposals, which were shared with each specialized committee. These are incorporated in our CSR activities of the IDEC Group.



CSR Workplace Training sessions for employees, held at the HQ cafeteria

TOPIC

CSR procurement activities, together with suppliers

Since FY2019, the IDEC Group has promoted CSR procurement, according to its CSR Procurement Guidelines and Green Procurement Guidelines, in cooperation with suppliers, in order to conduct CSR activities throughout its supply chain. Initiatives concerning respect for human rights, creation of a friendly workplace environment, environmental consideration, responsible mineral procurement, and a business continuity plan (BCP) have been set and 50 suppliers conducted self-assessment regarding these issues in FY2021. Based on the results, CSR auditing will be conducted.